

Lacor

75

years next to you



Catálogo interactivo · Interactive catalogue

Fácil de navegar · Easy to navigate

Índice interactivo · Interactive index



Páginas interactivas · Interactive pages



Descubre más sobre los productos · Find out more about the products

Videos demostrativos · Demonstration videos



Recetarios · Recipe book



Sostenibilidad · Sustainability

Cambiamos nuestros embalajes para un **#futuro** más sostenible.

Llevamos mucho tiempo trabajando en una importante **#iniciativa** que estamos implementando en Lacor; un **#compromiso** que compartimos con nuestros proveedores, suministradores y clientes: la mejora de los embalajes de los productos para reducir nuestro impacto medioambiental.

Estamos eliminando los plásticos de un solo uso y utilizando embalajes más **#sostenibles** y fáciles de **#reciclar**, descartando en la medida de lo posible los materiales compuestos que no son aptos o son complicados de reciclar.

Porque cada granito de arena cuenta. ¡Seguimos mejorando!

We changed our packaging for a more sustainable **#future**.

For a long time, we've been working on an important **#initiative** that we're implementing at Lacor. It's a **#commitment** that we share with our suppliers and clients and it is to improve product packaging to reduce our environmental impact.

We're eliminating single use plastic and using packaging that is more **#sustainable** and easier to **#recycle** and eliminating composite materials that are hard to recycle or cannot be recycled as much as possible.

Because every grain of sand counts. We keep improving!



Novedades - Novelties



Batería **COMBI**
Battery
« 32 / 33 »



Batería **ORIGIN**
Battery
« 34 / 35 »



Sartén **FOODIE**
Frying pan
« 37 / 101 »



Cazo **GARINOX**
Saucepan
« 53 »



Sartén-Grill-Wok-Crepera **EASY**
Frying pan-Grill- Wok-Crepiere
« 61 »



Olla a presión **GENIUS**
Pressure Cookers
« 75 »



Wok **FERRUM**
Wok
« 84 »



Wok **BASIC**
Wok
« 85 »



Wok **RUSTIC**
Wok
« 85 »



Sartén **TRICHEF**
Fryingpan
« 99 »



Bandeja **ESSENTIAL**
Tray
« 103 »



Bandeja **MASTER**
Tray
« 105 »



Guante **RED**
Kitchen glove
« 108 »



Guante **BLACK**
Kitchen glove
« 108 »



Paellera **TRICHEF**
Round dish
« 116 »



Soporte para hornear **PIZZA**
Baking rack
« 136 »



Pala pizza **WOOD**
Pizza peel
« 137 »



Cortapizza **PRO**
Pizza cutter
« 137 »



Espátula **TARROS**
Spatula
« 141 / 469 »



Espátula **EXTRAPLANA**
Spatula
« 141 / 469 »



Batidor **FIBREGLASS**
Whisk
« 143 / 467 »





Set 3 **JARRAS** medidoras
Set 3 jar
« 145 / 459 »



Colección **ETERN & ECOINOX**
Collection
« 151 »



Hervidor extensible **FLOR**
Extendable
« 156 »



Pinza **QUITAESPINAS**
Fish-bone tweezers
« 252 »



Cubitera **GLACIER**
Ice bucket
«280 »



Cubitera **FRESH**
Ice bucket
« 281 »



Prensador
Presser
« 164 »



Prensa **PATATAS**
Potato press
« 164 »



MAZA ablandacarnes
Meat tenderiser
« 165 »



Cubitera **ICE**
Ice bucket
«281 »



Cubitera **ICE XL**
Ice bucket
« 281 »



Taza **MOSCOW MULE**
Mug
« 292 »



MAZA ablandacarnes
Meat tenderiser
« 165 »



Prensa hamburguesa **PRO**
Hamburger press
« 166 »



Exprimidor manual **INOX**
Manual juicer
« 169 »



Pelador de piña **SLIZE**
Pineapple peeler
« 331 »



Cortador de patatas **ONDULADO**
Potato cutter
« 336 »



Mandolina vertical **PRECIS**
Vertical mandolin
« 343 »



Sifón **EPICURE**
Siphon
« 178 / 482 »



Fondue Grey **PLUS**
Grey fondue
« 224 / 569 »



Soporte **TACOS**
Taco stand
« 234 »



Cuchillo **ELITE & MASTER**
Knife
« 350 »



Cuchillo **CHULETERO**
Knife
« 353 »



Cuchillos **CORTAQUESOS**
Cutlery knives
« 356 »



Bandeja **CUENCOS**
Tray bowls
« 236 »



Bandeja **ZENSAI**
Tray
« 236 »



Tabla **BANBÚ & MARMOL**
Bamboo & marble table
« 236 »



TACO de cuchillos
Knife block
« 359 »



Afilador de cuchillos **VERTICAL**
Knife sharpener
« 360 »



Afilador de cuchillos **MINI**
Knife sharpener
« 360 »





SOPORTE para tablas
Support for boards

<< 369 >>



Cacerolas **BUFFET**
Pans

<<386 >>



Vajilla catering **DEGUSTARE**
Catering crockery

<< 387 >>



Aro **CORAZÓN** perforado
Perforated ring

<< 509 >>



Aro **HOJA** perforado
Perforated ring

<< 509 >>



Arrocera **WHITE**
Rice Cooker

<< 514 >>



Buffet & Display
Buffet & Display

<< 389 >>



Bandeja **PIZARRA**
Slate Tray

<< 390 >>



Plato **GIRATORIO**
Turntable

<< 391 >>



Yogurtera **DEVA**
Yoghurt maker

<< 519 >>



Freidora de aire **dAirePRO**
Air fryer

<< 549 >>



Freidora de aire **CrystalFry**
Air Fryer

<< 551 >>



Soporte **EXPOSITOR**
Display Stand

<< 391 >>



Frutero **DUAL SQ**
Fruit bowl

<< 396 >>



LÁMPARA extensible
Extendable lamp

<< 407 / 577 >>



Microondas **TEMPO**
Microwave

<< 556 >>



Grill abatible **TOTALLY**
Folding grill

<< 563 >>



Grill abatible **CONTROLLE**
Folding grill

<< 563 >>



Cubeta **HELADO**
Ice bucket

<< 419 >>



Caja isométrica **TEMPLE**
Isometric box

<< 425 >>



Rodillos **ROLLER**
Rollers

<< 473 >>



Crepera **TITANPRO**
Crepe maker

<< 567 >>



Picadora de **HIELO**
Ice crusher

<< 626 >>



PLACA de calentamiento
Heating plate

<< 574 / 404 >>



Set **CORTARTAS**
Cake cutter set

<< 475 >>



Espátula para atemperar **CHOCOLATE**
Spatula for tempering chocolate

<< 476 >>



Espátula para galletas **TASTY**
Biscuit spatula

<< 488 >>



20

Baterías profesionales

Professional cookware

32

Baterías domésticas

Household cookware

71

Ollas a presión

Pressure cookers

80

Sartenes

Frypans

103

Rustideras · Horno

Roasting pans · Oven

115

Paelleras

Paella pans

01

Menaje
Cookware

122

Juegos de cocina

Kitchen tools

133

Preparación

Food processing

183

Básculas · Termómetros

Scales · Thermometers

02

Utensilios
Utensils

192

Bandejas · Fuentes

Thermos · Bottles

198

Melamina

Melamine

215

Servicio Mesa

Table service

248

Pinzas

Tongs

256

Cafetería

Coffee

272

Termos · Botellas

Thermos · Bottles

279

Bar · Bodega

Wine cellar

306

Portamenú

Portamenu

03

Mesa
Table Top

328

Corte

Cutting

04

Corte
Cutting

374

Chafing dish + Buffet

Chafing dish + Buffet

05

Buffet
Buffet

414

Cubetas

Container

425

Transporte · Estanterías

Transport · Shelves

444

Cestas

Racks

448

Limpieza

Cleaning

06

Gastronorm
Gastronorm

458

Preparación repostería

Pastry processing

492

Moldes · Aros

Moulds · Rings

07

Repostería
Pastry

512

Eléctrico

Electric

08

Eléctrico
Electric

1949-2024

1949

En 1949, Marcos Larrañaga Chinchurreta fundó la empresa "Manufacturas Metálicas Marcos Larrañaga" en un pequeño local del centro de Bergara.

In 1949, Marcos Larrañaga Chinchurreta founded the company Manufacturas Metálicas Marcos Larrañaga in small premises in the centre of Bergara.



1950

Comenzamos a fabricar en aluminio los artículos para uso doméstico y material de ortodoncia para empresas de la comarca del Alto Deba en Gipuzkoa.

We started manufacturing aluminium household items and orthodontic materials for companies in the Alto Deba region in Gipuzkoa.

1960

Trasladamos y ampliamos las instalaciones para poder fabricar menaje de aluminio para el sector de la hostelería y, posteriormente, comenzamos a fabricar las primeras piezas de acero inoxidable para el hogar. Asimismo, decidimos crear la marca comercializadora "Lacor" en honor al matrimonio que formaban el fundador Marcos Larrañaga y su mujer Casimira Cortabarría.

We moved and expanded our facilities in order to manufacture aluminium kitchenware for the hotel and catering industry and then started to manufacture the first stainless steel household articles. We also decided to create the brand name "Lacor" in honour of the married couple formed by the founder, Marcos Larrañaga, and his wife, Casimira Cortabarría.



1970

Mejoramos las piezas de acero inoxidable incluyendo el fondo difusor, además de ampliar la gama para el sector profesional. Comenzamos a exportar nuestros productos a los países contiguos Francia y Portugal.

We improved the stainless steel items by including a heat-diffusing bottom, as well as extending the professional kitchenware range. We started exporting our products to the neighbouring countries of France and Portugal.



1980

Nos convertimos en el primer fabricante nacional de menaje en grandes dimensiones de acero inoxidable con fondo difusor y de una sola pieza. Así, tuvimos que volver a trasladar y ampliar las instalaciones actuales de Bergara, además de automatizar la producción.

Seguimos trabajando para ampliar el catálogo profesional y conseguimos expandir las ventas a los 5 continentes.

We became the first national manufacturer of large single piece stainless steel kitchenware featuring a heat-diffusing bottom, so we had to relocate and expand the current facilities in Bergara, as well as automate production.

We continuously strived to expand our professional portfolio and managed to increase sales to 5 continents.



2000

Creamos la empresa "Logística del Menaje" en Alegría-Dulantzi (10.000 m2) con su posterior ampliación hasta los 30.000 m2 para almacenar y gestionar los centenares de pedidos diarios de nuestros clientes.

Igualmente, invertimos en las automatizaciones y robotizaciones en la producción para optimizar los recursos y mejorar el acabado de las piezas.

We created the company Logística del Menaje in Alegría-Dulantzi (10,000m2), followed by a subsequent extension to 30,000 m2 to store and manage the hundreds of daily orders from our customers.

We also invested in production automation and robotisation to optimise resources and improve finishing of parts



2024...

Nos consolidamos como marca líder de menaje profesional para hostelería y restauración.

Nuestros productos se caracterizan por el diseño, la calidad y la durabilidad, atributos que día a día conquistan a grandes chefs de todo el mundo.

Tratamos de contribuir a una sociedad saludable y sostenible. Promovemos el aprendizaje y el desarrollo de hábitos de vida saludables incorporando al catálogo materiales seguros y libre de tóxicos.

We have now consolidated our position as a leading brand in professional kitchenware for the hotel and catering industry.

Our products are well-known for their design, quality and durability, features that convince top chefs from all over the world on a daily basis.

We do our best to contribute to a healthy, sustainable society and promote learning and the development of a healthy lifestyle by including safe, toxic-free materials in our catalogue.



Nuestros valores • Nos valeurs • Our values

Liderazgo Leadership Leadership

Somos una marca referencia dentro del sector de la hostelería y menaje doméstico. Tras años de esfuerzo nos hemos ganado una posición de liderazgo y nos hemos convertido en un referente en el sector.

Nous sommes une marque de référence dans le secteur de l'hôtellerie et des ustensiles de cuisine. Après des années d'efforts, nous avons acquis une position de leadership et sommes devenus une référence dans le secteur.

We're a leading brand in the hospitality and home kitchenware industries. After years of effort we've earned a leadership position and we're at the forefront of the sector.

Ambición Ambition Ambition

Estamos presentes en 90 países a lo largo de los 5 continentes. A través del esfuerzo de nuestros distribuidores, hemos conseguido llegar a las cocinas profesionales y hogares de todo el mundo.

Nous sommes présents dans 90 pays situés sur 5 continents. Grâce à l'effort de nos distributeurs, nous sommes parvenus à rentrer dans les cuisines professionnelles et les foyers du monde entier.

We're present in 90 countries on 5 continents. Through the effort of our distributors we've been able to reach homes and professional kitchens around the world.

Compromiso Engagement Commitment

Integramos la cultura de la calidad tanto en los procesos de fabricación y productos como en la relación con nuestros clientes y colaboradores.

Nous intégrons la culture de la qualité aussi bien dans les processus de fabrication et les produits que dans la relation avec nos clients et nos collaborateurs.

We have assimilated the culture of quality in both our manufacturing processes and products and our relationships with clients and collaborators.

Organización Organisation Organization

Pertenece a una tierra de profundas raíces gastronómicas donde nuestros artesanos comenzaron a fabricar las primeras cacerolas hace 75 años. Hoy en día mantenemos el mismo espíritu y pasión por nuestra propia historia.

Nous sommes issus d'une région possédant de profondes racines gastronomiques où nos artisans ont commencé à fabriquer les premières casseroles il y 75 ans. Aujourd'hui, nous avons gardé le même état d'esprit et la même passion pour notre propre histoire.

We belong to a land with deep gastronomic roots where our artisans began to make the first casseroles 75 years ago. Today, we still have the same spirit and passion for our history.

Responsabilidad Responsabilité Responsibility

Contamos con un equipo cualificado de personas con un alto grado de responsabilidad hacia el servicio. Gracias a la dedicación diaria, hemos conseguido establecer relaciones duraderas y de confianza con nuestros clientes.

Nous bénéficions d'une équipe de personnes qualifiées avec un haut niveau de responsabilité vis-à-vis du service. Grâce à leur dévouement quotidien, nous avons pu établir des relations durables et de confiance avec nos clients.

We have a qualified team of people with a high degree of responsibility towards service. Thanks to our day in day out dedication, we've been able to build long lasting and trusting relationships with our clients.



Conócenos · Connais-nous · Know us

Fábrica

Usine · Factory

· **Fábrica ubicada en Bergara (España)**

· Usine située en Bergara (Espagne)

· Factory located in Bergara (Spain)



Almacén

Entrepôt · Warehouse

· **Almacén de 30.000 m2**
· **Capacidad: 42.000 pallets**

· Entrepôt de 30.000 m2
· Capacité: 42.000 pallets

· Warehouse 30.000 m2
· Capacity: 42.000 pallets



Distribuidores

Distributeurs · Distributors

· **Más de 3200 distribuidores**
· **Presentes en 90 países**

· Plus de 3200 distributeurs
· Présent dans 90 pays

· More than 3200 distributors
· Present in 90 countries



Lacor Worldwide

Europe

Andorra · Austria · Belgium · Bulgaria · Czech Republic · Croatia · Cyprus · Denmark · Finland · France · Germany · Greece · Holland · Hungary · Iceland · Ireland · Italy · Latvia · Lithuania · Luxembourg · Macedonia · Montenegro · Poland · Portugal · Romania · Russia · Serbia · Slovenia · Spain · Sweden · Switzerland · Turkey · UK+ · N. Ireland · Ukraine

America

Argentina · Bolivia · Brazil · Canada · Chile · Colombia · Costa Rica · Cuba · Dominican Rep. · French Guayana · Guadalupe · Guatemala · Honduras · Jamaica · Martinique · Mexico · Paraguay · Peru · United States · Uruguay

Asia

Azerbaijan · Cambodia · China · Hong Kong · India · Indonesia · Iran · Iraq · Israel · Japan · Jordan · Kazakhstan · Kuwait · Lebanon · Macau · Malaysia · Philippines · Qatar · Russia · Saudi Arabia · Singapore · South Korea · Sri Lanka · Taiwan · Thailand · UAE · Vietnam

Africa

Algeria · Burkina Faso · Cape Verde · Egypt · Ethiopia · Ivory Coast · Kenya · Libya · Mauricio · Morocco · Reunion Island · Senegal · Seychelles · South Africa · Tunisia

Oceania

Australia · New Zeland

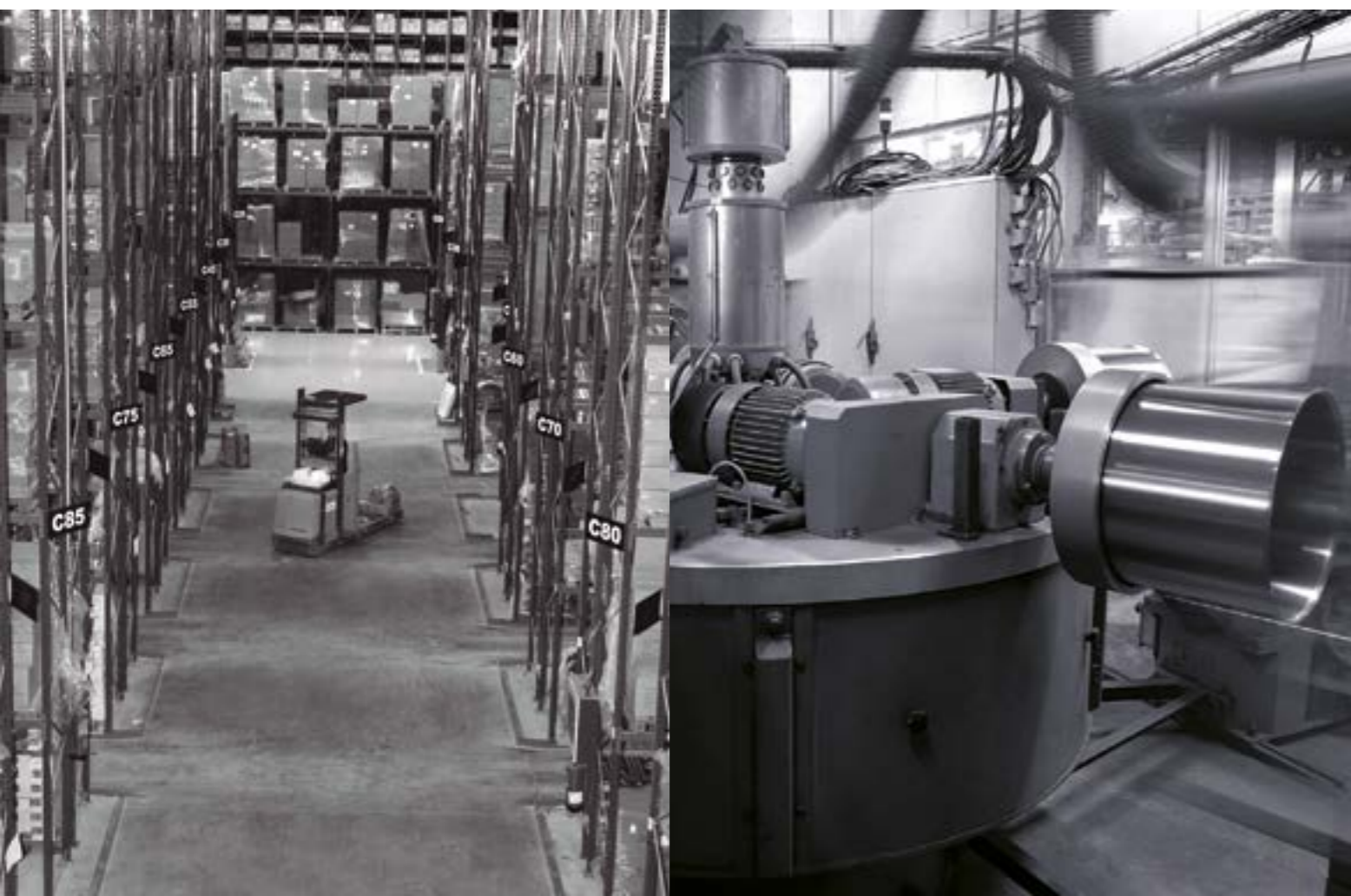

CHEF-LUXE

Batería



ES

- Toda la pieza (cuerpo, asas y mangos) fabricada en acero inoxidable 18/10.
- Fondo termodifusor (inox 18/10 - aluminio - inox).
- Espesor 1,5 - 2 mm.
- Tapas diseñadas para el ahorro energético.
- Máxima garantía en cuanto a resistencia, durabilidad e higiene.
- Apta para todos los tipos de cocina (incluida inducción y horno).

FR

- Toute la pièce (corps, poignées et manches) est fabriquée en acier inoxydable 18/10.
- Fond thermo-diffuseur (Inox 18/10 - Aluminium - Inox).
- Épaisseur 1,5 - 2 mm.
- Couvercles conçus pour une économie d'énergie.
- Garantie maximale en termes de résistance, de durabilité et d'hygiène.
- Compatible avec tous les types de cuisinières (y compris induction et four).

EN

- The whole product (body, handles and grips) is made in 18/10 stainless steel.
- Heat diffuser bottom (18/10 stainless steel - Aluminium - Stainless).
- Thickness 1.5 - 2 mm.
- Covers designed for saving energy.
- Maximum guarantee in terms of resistance, durability and hygiene.
- Suitable for all types of cooking surfaces (including induction and the oven).



Cacerola con tapa

Faitout avec couvercle · Bratentopf mit Deckel
Casserole with lid · Caçarola com tampa

Ref	€	Ø (cm)	h (cm)	e (mm)	L	U.Venta
54020	83,50	20	10,0	1,5	2,90	1
54024	100,00	24	11,0	1,5	4,25	1
54028	116,00	28	11,0	1,5	6,70	1
54032	144,30	32	12,5	1,5	10,00	1
54036	175,30	36	14,0	1,5	14,20	1
54040	226,60	40	15,5	2,0	19,40	1
54045	269,40	45	17,0	2,0	27,00	1
* 54050	337,80	50	20,0	2,0	38,20	1

* NO inducción · NON induction · NOT induction



Cacerola sin tapa

Faitout sans couvercle · Bratentopf ohne Deckel
Casserole without lid · Caçarola sem tampa

Ref	€	Ø (cm)	U.Venta
54020S	65,90	20	1
54024S	79,80	24	1
54028S	93,00	28	1
54032S	116,30	32	1
54036S	141,10	36	1
54040S	188,60	40	1
54045S	225,80	45	1
* 54050S	286,10	50	1

* NO inducción · NON induction · NOT induction

Cacerola alta con tapa

Braisiere avec couvercle · Fleischtopf mit Deckel
Deep casserole with lid · Caçarola alta com tampa

Ref	€	Ø (cm)	h (cm)	e (mm)	L	U.Venta
54021	87,30	20	13,0	1,5	4,00	1
54025	108,50	24	14,0	1,5	6,70	1
54029	132,00	28	17,5	1,5	10,70	1
54033	154,40	32	18,0	1,5	14,60	1
54037	197,00	36	21,5	1,5	21,80	1
54041	255,90	40	24,5	2,0	30,00	1
54046	303,60	45	27,5	2,0	43,70	1
* 54051	400,60	50	30,0	2,0	58,80	1

* NO inducción · NON induction · NOT induction

Cacerola alta sin tapa

Braisiere sans couvercle · Fleischtopf ohne Deckel
Deep casserole without lid · Caçarola alta sem tampa

Ref	€	Ø (cm)	U.Venta
54021S	69,60	20	1
54025S	88,40	24	1
54029S	109,20	28	1
54033S	126,30	32	1
54037S	162,90	36	1
54041S	217,90	40	1
54046S	260,00	45	1
* 54051S	348,80	50	1

* NO inducción · NOT induction



Olla recta con tapa

Marmite traiteur avec couvercle · Suppentopf mit Deckel
Casserole with lid · Caçarola com tampa

Ref	€	Ø (cm)	h (cm)	e (mm)	L	U.Venta
54120	96,70	20	20,0	1,5	6,20	1
54124	117,70	24	24,0	1,5	10,50	1
54128	142,40	28	28,0	1,5	17,20	1
54132	193,10	32	32,0	1,5	25,70	1
54136	238,50	36	36,0	1,5	36,50	1
54140	297,20	40	40,0	2,0	50,00	1
54145	380,30	45	45,0	2,0	71,50	1
* 54150	537,30	50	50,0	2,0	98,00	1

* NO inducción · NON induction · NOT induction

Olla recta sin tapa

Marmite traiteur s/couvercle · Suppentopf ohne Deckel
Stock Pot without lid · Panela sem tampa

Ref	€	Ø (cm)	U.Venta
54120S	79,00	20	1
54124S	97,70	24	1
54128S	119,40	28	1
54132S	165,00	32	1
54136S	204,90	36	1
54140S	259,30	40	1
54145S	336,80	45	1
* 54150S	485,40	50	1

* NO inducción · NOT induction



Olla baja con tapa

Marmite basse avec couvercle · Gemüsetopf mit Deckel
Low casserole with lid · Caçarola baixa com tampa

Ref	€	Ø (cm)	h (cm)	e (mm)	L	U.Venta
54119	90,20	20	15,0	1,5	4,70	1
54123	110,80	24	20,0	1,5	9,00	1
54127	138,60	28	22,0	1,5	13,50	1
54131	181,50	32	26,0	1,5	20,00	1
54135	204,10	36	29,0	1,5	29,50	1
54139	278,30	40	32,0	2,0	40,00	1

Olla baja sin tapa

Marmite basse s/couvercle · Gemüsetopf ohne Deckel
Low stock pot without lid · Panela baixa sem tampa

Ref	€	Ø (cm)	U.Venta
54119S	73,40	20	1
54123S	90,60	24	1
54127S	115,50	28	1
54131S	153,30	32	1
54135S	170,10	36	1
54139S	240,20	40	1



Tartera con tapa

Plat rond avec couvercle · Pflanne mit Deckel
Round dish with lid · Paelheira com tampa

Ref	€	Ø (cm)	h (cm)	e (mm)	L	U.Venta
54636	169,50	36	7,0	1,5	7,00	1
54640	206,30	40	8,0	1,5	10,00	1
54645	238,90	45	8,5	2,0	12,00	1
* 54650	301,50	50	9,0	2,0	17,00	1

* NO inducción · NON induction · NOT induction

Tartera sin tapa

Plat rond s/couvercle · Pflanne ohne Deckel
Round dish without lid · Paelheira sem tampa

Ref	€	Ø (cm)	U.Venta
54636S	134,10	36	1
54640S	166,30	40	1
54645S	193,00	45	1
* 54650S	246,80	50	1





Cazo recto

Casserole · Stielkasserolle, flach
Saucepan · Caçarola direita

Ref	€	Ø (cm)	h (cm)	e (mm)	L	U.Venta
54212	43,00	12	7,0	1,2	0,75	1
54214	45,50	14	7,5	1,2	1,10	1
54216	48,10	16	8,0	1,5	1,60	1
54218	52,70	18	9,0	1,5	2,25	1
54220	59,10	20	10,0	1,5	2,90	1
* 54224	77,80	24	10,0	1,5	4,25	1
* 54228	89,90	28	11,0	1,5	6,70	1

* Con asa · Avec poignée · With handle



Cazo Francés

Casserole Française · Stielkasserolle, französisch
French saucepan · Francês caçarola direita

Ref	€	Ø (cm)	h (cm)	e (mm)	L	U.Venta
54225N	76,30	24	12,0	1,5	5,40	1
54229N	97,90	28	14,0	1,5	8,60	1



Sautex

Sauteuse · Sauteuse
Sauteuse · Frigideira

Ref	€	Ø (cm)	h (cm)	e (mm)	L	U.Venta
* 54621	57,40	20	6,5	1,5	1,80	1
54625	69,60	24	6,5	1,5	2,70	1
54629	85,60	28	7,0	1,5	4,00	1
54633	107,20	32	8,5	1,5	4,70	1
54637	129,20	36	10,0	1,5	7,00	1

* Sin asa · Sans poignée · Without handle



Cazo recto alto

Casserole haute · Stielkasserolle
Deep saucepan · Caçarola alta direita

Ref	€	Ø (cm)	h (cm)	e (mm)	L	U.Venta
54217	50,60	16	11,0	1,5	2,20	1
54219	59,20	18	12,0	1,5	3,00	1
54221	62,40	20	13,0	1,5	4,00	1
* 54225	89,10	24	14,0	1,5	6,70	1
* 54229	104,90	28	17,5	1,5	10,70	1

* Con asa · Avec poignée · With handle



Cazo cónico

Sautase conique · Sauteuse, Konisch
Conical saute pan · Caçarola cónica

Ref	€	Ø (cm)	h (cm)	e (mm)	L	U.Venta
55216	48,10	16	6,0	1,5	1,00	1
55220	53,10	20	6,5	1,5	1,60	1
55224	62,10	24	7,5	1,5	2,70	1



Tapa

Couvercle · Deckel
Lid · Tampa

Ref	€	Ø (cm)	U.Venta
54916	16,10	16	1
54920	17,40	20	1
54924	20,00	24	1
54928	22,70	28	1
54932	27,80	32	1
54936	33,70	36	1
54940	38,00	40	1
54945	43,60	45	1
54950	51,80	50	1

CHEF-CLASSIC

Batería

Inox
18/10



ES

- Toda la pieza (cuerpo, asas y mangos) fabricada en acero inoxidable 18/10.
- Fondo termodifusor (inox 18/10 - aluminio - inox).
- Espesor 0,7 - 1,2 mm.
- Tapas diseñadas para el ahorro energético.
- Apta para todos los tipos de cocina (incluida inducción y horno). * Excepto Ø60 cm.
- Acabado mate interior y exterior.
- Máxima garantía en cuanto a resistencia, durabilidad e higiene.

FR

- Toute la pièce (corps, poignées et manches) est fabriquée en acier inoxydable 18/10.
- Fond thermo-diffuseur (Inox 18/10 - Aluminium - Inox).
- Épaisseur 0,7 - 1,2 mm.
- Couverts conçus pour une économie d'énergie.
- Compatible avec tous les types de cuisinières (y compris induction et four). * Excepté Ø60 cm.
- Finition mate intérieur et extérieur.
- Garantie maximale en termes de résistance, de durabilité et d'hygiène.

EN

- The whole product (body, handles and grips) is made in 18/10 stainless steel.
- Heat diffuser bottom (18/10 stainless steel - Aluminium - Stainless).
- Thickness 0.7 - 1.2 mm.
- Covers designed for saving energy.
- Suitable for all types of cooking surfaces (including induction and the oven). * Except Ø60 cm.
- Interior and exterior matte finish.
- Maximum guarantee in terms of resistance, durability and hygiene.



Cacerola con tapa

Faitout avec couvercle · Bratentopf mit Deckel
Casserole with lid · Caçarola com tampa

Ref	€	Ø (cm)	h (cm)	e (mm)	L	U.Venta
50016	49,70	16	8,0	0,7	1,60	1
50020	59,10	20	9,0	0,7	2,80	1
50024	67,10	24	9,5	0,8	4,25	1
50028	92,70	28	11,0	0,8	6,75	1
50032	116,20	32	12,5	0,8	10,00	1
50036	155,40	36	14,0	1,0	14,20	1
50040	180,20	40	15,5	1,0	19,40	1
50045	212,30	45	17,0	1,0	27,00	1
50050	294,50	50	20,0	1,0	38,20	1
* 50060	419,60	60	25,0	1,2	70,00	1

* NO inducción · NON induction · NOT induction



Cacerola sin tapa

Faitout sans couvercle · Bratentopf ohne Deckel
Casserole without lid · Caçarola sem tampa

Ref	€	Ø (cm)	U.Venta
50016S	39,30	16	1
50020S	45,60	20	1
50024S	52,30	24	1
50028S	75,90	28	1
50032S	93,80	32	1
50036S	128,60	36	1
50040S	149,80	40	1
50045S	176,00	45	1
50050S	250,00	50	1
* 50060S	361,40	60	1

* NO inducción · NOT induction

Cacerola alta con tapa

Braisiere avec couvercle · Fleischtopf mit Deckel
Deep casserole with lid · Caçarola alta com tampa

Ref	€	Ø (cm)	h (cm)	e (mm)	L	U.Venta
50017	51,40	16	11,0	0,7	2,20	1
50021	63,50	20	13,0	0,7	4,00	1
50025	73,40	24	14,0	0,8	6,75	1
50029	96,30	28	17,5	0,8	10,00	1
50033	120,70	32	18,0	0,8	14,40	1
50037	169,40	36	21,5	1,0	21,80	1
50041	199,70	40	24,5	1,0	30,70	1
50046	236,60	45	27,5	1,0	43,70	1
50051	331,00	50	30,0	1,2	58,80	1
* 50061	477,30	60	35,0	1,2	98,00	1

* NO inducción · NOT induction

Cacerola alta sin tapa

Braisiere sans couvercle · Fleischtopf ohne Deckel
Deep casserole without lid · Caçarola alta sem tampa

Ref	€	Ø (cm)	U.Venta
50017S	41,10	16	1
50021S	50,00	20	1
50025S	59,90	24	1
50029S	79,50	28	1
50033S	103,90	32	1
50037S	142,60	36	1
50041S	172,90	40	1
50046S	200,30	45	1
50051S	294,70	50	1
* 50061S	419,10	60	1

* NO inducción · NOT induction



Cazo recto

Casserole · Stielkasserolle, flach
Saucepan · Caçarola direite

Ref	€	Ø (cm)	h (cm)	e (mm)	L	U.Venta
50212	27,40	12	7,0	0,7	0,75	1
50214	29,50	14	7,5	0,7	1,10	1
50216	32,40	16	8,0	0,8	1,60	1
50218	35,00	18	9,0	0,8	2,20	1
50220	38,70	20	9,0	0,8	2,80	1
50224	47,70	24	9,5	0,8	4,25	1
50228	66,90	28	11,0	0,8	6,75	1



Cazo recto alto

Casserole haute · Stielkasserolle, hoch
Deep saucepan · Caçarola alta direite

Ref	€	Ø (cm)	h (cm)	e (mm)	L	U.Venta
50217	34,60	16	11,0	0,8	2,10	1
50219	40,10	18	12,0	0,8	3,00	1
50221	45,20	20	13,0	0,8	4,00	1
50225	55,10	24	14,0	0,8	6,30	1
50229	74,90	28	17,5	0,8	10,20	1



Baño maría con fondo

Bahut avec fond · Bain Marie Topf
Double boiler with bottom · Banho-Maria com fundo

Ref	€	Ø (cm)	h (cm)	e (mm)	L	U.Venta
50717	39,80	16	16,0	0,8	3,20	1
50721	51,70	20	20,0	0,8	6,20	1



Sautex

Sauteuse · Sauteuse
Sauteuse · Frigideira

Ref	€	Ø (cm)	h (cm)	e (mm)	L	U.Venta
50625	46,20	24	6,5	0,8	2,70	1
50629	63,80	28	7,0	0,8	4,00	1
50633	72,20	32	8,5	0,8	4,70	1
50637	104,10	36	10,0	1,0	7,00	1



Tapa

Couvercle · Deckel
Lid · Tampa

Ref	€	Ø (cm)	U.Venta
50916	10,30	16	1
50918	11,50	18	1
50920	13,50	20	1
50924	14,80	24	1
50928	16,90	28	1
50932	22,40	32	1
50936	26,80	36	1
50940	30,40	40	1
50945	36,30	45	1
50950	44,60	50	1
50960	58,20	60	1

Olla recta con tapa

Marmite traiteur avec couvercle · Suppentopf mit Deckel
Stock pot with lid · Panela com tampa

Ref	€	Ø (cm)	h (cm)	e (mm)	L	U.Venta
50116	55,10	16	16,0	0,8	3,20	1
50120	70,40	20	20,2	0,8	6,20	1
50124	88,60	24	24,0	0,8	10,50	1
50128	121,00	28	28,0	1,0	17,20	1
50132	171,50	32	32,0	1,0	25,70	1
50136	208,00	36	36,0	1,0	36,60	1
50140	248,90	40	40,0	1,2	50,00	1
50145	319,60	45	45,0	1,2	68,30	1
50150	500,70	50	50,0	1,2	98,00	1
* 50160	703,20	60	50,0	1,2	141,00	1

* NO inducción · NOT induction

Olla recta sin tapa

Marmite traiteur s/couvercle · Suppentopf ohne Deckel
Stock Pot without lid · Panela sem tampa

Ref	€	Ø (cm)	U.Venta
50116S	44,80	16	1
50120S	57,00	20	1
50124S	73,80	24	1
50128S	104,10	28	1
50132S	149,10	32	1
50136S	181,20	36	1
50140S	218,40	40	1
50145S	283,30	45	1
50150S	456,10	50	1
* 50160S	644,90	60	1

* NO inducción · NOT induction



Cazo Francés

Casserole Française · Stielkasserolle, französisch
French saucepan · Francês caçarola direite

Ref	€	Ø (cm)	h (cm)	e (mm)	L	U.Venta
50225N	52,90	24	12,0	0,8	5,50	1
50229N	68,50	28	14,0	0,8	8,50	1



Cazo cónico

Sautase conique · Sauteuse, Konisch
Conical saute pan · Caçarola cónica

Ref	€	Ø (cm)	h (cm)	e (mm)	L	U.Venta
51216	39,30	16	6,0	1,0	1,00	1
51218	41,40	18	6,0	1,0	1,20	1
51220	43,20	20	6,5	1,0	1,60	1
51222	47,20	22	7,0	1,0	2,10	1
51224	51,70	24	7,5	1,0	2,70	1

Olla baja con tapa

Marmite basse a/couvercle · Gemüsetopf mit Deckel
Low stock pot with lid · Panela baixa com tampa

Ref	€	Ø (cm)	h (cm)	e (mm)	L	U.Venta
50119	63,00	20	15,0	0,8	4,70	1
50123	84,20	24	20,0	0,8	9,00	1
50127	109,90	28	22,0	0,8	13,50	1
50131	160,10	32	26,0	1,0	20,80	1
50135	185,90	36	29,0	1,0	29,50	1
50139	234,60	40	32,0	1,2	40,00	1

* NO inducción · NOT induction

Olla baja sin tapa

Marmite basse s/couvercle · Gemüsetopf ohne Deckel
Low stock pot without lid · Panela baixa sem tampa

Ref	€	Ø (cm)	U.Venta
50119S	49,60	20	1
50123S	69,40	24	1
50127S	93,00	28	1
50131S	137,70	32	1
50135S	159,10	36	1
50139S	204,20	40	1

* NO inducción · NOT induction



Paellera con tapa

Plat rond a/couvercle · Pfanne mit Deckel
Round with lid · Paelheira com tampa

Ref	€	Ø (cm)	h (cm)	e (mm)	L	U.Venta
50624	63,00	24	6,0	0,8	2,70	1
50628	85,20	28	6,0	0,8	3,60	1
50632	110,20	32	6,0	0,8	5,00	1
50636	139,30	36	7,0	1,0	7,10	1
50640	160,60	40	8,0	1,0	10,00	1
50645	188,60	45	8,5	1,0	13,50	1
50650	244,60	50	9,0	1,0	17,60	1
* 50660	353,80	60	9,0	1,0	25,40	1

* NO inducción · NOT induction

Paellera sin tapa

Plat rond s/couvercle · Pfanne ohne Deckel
Round dish without lid · Paelheira sem tampa

Ref	€	Ø (cm)	U.Venta
50624S	48,30	24	1
50628S	68,40	28	1
50632S	87,80	32	1
50636S	112,50	36	1
50640S	130,20	40	1
50645S	152,30	45	1
50650S	200,10	50	1
* 50660S	295,50	60	1

* NO inducción · NOT induction



Rustidera

Plat à roir · Bratpfanne
Roaster · Assadeira

Ref	€	cm	h (cm)	e (mm)	U.Venta
50540	115,20	40x30	8,0	1,0	1
50550	152,60	50x40	8,0	1,0	1
50560	192,20	60x45	8,0	1,0	1
50570	219,60	70x45	9,5	1,0	1



Cacerola vapor

Panier vapeur · Dampfkoch-Aussatz o/Untertopf
Steam casserole · Caçarola a vapor

Ref	€	Ø (cm)	h (cm)	e (mm)	U.Venta
50428	58,90	28	11,0	0,8	1
50432	65,00	32	12,5	0,8	1

ECO-CHEF

Batería



Máxima garantía en resistencia y durabilidad
 Maximun guarantee in resistance and durability



ES

- Toda la pieza (cuerpo, asas y mangos) fabricada en acero inoxidable.
- Fondo termodifusor (inox 18/10 - aluminio - inox). Espesor 0,6 - 1 mm.
- Tapas diseñadas para el ahorro energético.
- Apta para todos los tipos de cocina (incluida inducción y horno).
- Acabado interior mate y exterior brillo-mate.
- Máxima garantía en cuanto a resistencia, durabilidad e higiene.

FR

- Toute la pièce (corps, poignées et manches) est fabriquée en acier inoxydable.
- Fond thermo-diffuseur (Inox 18/10 - Aluminium - Inox). Épaisseur 0,6 - 1 mm.
- Couvercles conçus pour une économie d'énergie.
- Compatible avec tous les types de cuisinières (y compris induction et four).
- Finition mate intérieur et brillant-mate extérieur.
- Garantie maximale en termes de résistance, de durabilité et d'hygiène.

EN

- The whole product (body, handles and grips) is made in stainless steel.
- Heat diffuser bottom (18/10 stainless steel - Aluminium - Stainless). Thickness 0.6 - 1 mm.
- Covers designed for saving energy.
- Suitable for all types of cooking surfaces (including induction and the oven).
- Interior matte finish and exterior brightness-matte finish.
- Maximum guarantee in terms of resistance, durability and hygiene.



Cacerola sin tapa

Faitout sans couvercle · Bratentopf ohne Deckel
 Casserole without lid · Caçarola sem tampa

Ref	€	Ø (cm)	h (cm)	e (mm)	L	U.Venta
57016	28,50	16	8,0	0,6	1,60	1
57020	35,00	20	9,0	0,6	2,80	1
57024	38,30	24	9,5	0,7	4,25	1
57028	60,80	28	11,0	0,7	6,75	1
57032	72,50	32	12,5	0,7	10,00	1
57036	111,80	36	14,5	0,7	14,20	1
57040	127,30	40	15,5	0,9	19,40	1



Cacerola alta sin tapa

Braisiere sans couvercle · Fleischtopf ohne Deckel
 Deep casserole without lid · Caçarola alta sem tampa

Ref	€	Ø (cm)	h (cm)	e (mm)	L	U.Venta
57017	30,40	16	11,0	0,6	2,20	1
57021	36,90	20	13,0	0,6	4,00	1
57025	45,20	24	15,0	0,7	7,00	1
57029	66,50	28	17,5	0,7	10,00	1
57033	80,40	32	18,0	0,7	14,40	1
57037	122,60	36	21,5	0,9	21,80	1
57041	150,40	40	24,5	0,9	30,70	1



Olla recta sin tapa

Marmite traiteur sans couvercle · Suppentopf ohne Deckel
 Stock pot without lid · Panela sem tampa

Ref	€	Ø (cm)	h (cm)	e (mm)	L	U.Venta
57116	34,70	16	16,0	0,7	3,20	1
57120	40,60	20	20,0	0,7	6,20	1
57124	57,10	24	24,0	0,7	10,50	1
57128	84,20	28	25,5	0,9	16,50	1
57132	126,20	32	32,0	0,9	25,70	1
57136	158,50	36	36,0	0,9	36,60	1
57140	195,10	40	40,0	1,0	50,00	1



Paellera sin tapa

Plat rond sans couvercle · Pfanne ohne Deckel
 Round without lid · Paelheira sem tampa

Ref	€	Ø (cm)	h (cm)	e (mm)	L	U.Venta
57624	37,70	24	6,5	0,7	3,00	1
57628	52,20	28	6,5	0,7	4,00	1
57632	66,70	32	7,0	0,7	5,00	1
57636	91,80	36	7,0	0,9	7,10	1
57640	105,80	40	8,0	0,9	10,00	1



Tapa

Couvercle · Deckel
 Lid · Tampa

Ref	€	Ø (cm)	U.Venta
57916	11,00	16	1
57920	13,90	20	1
57924	15,10	24	1
57928	17,40	28	1
57932	22,50	32	1
57936	27,70	36	1
57940	31,30	40	1



Cazo recto

Casserole · Stielkasserolle, flach
 Saucepan · Caçarola direite

Ref	€	Ø (cm)	h (cm)	e (mm)	L	U.Venta
57212	21,60	12	7,0	0,6	0,75	1
57214	23,10	14	7,5	0,6	1,10	1
57216	24,50	16	8,0	0,6	1,60	1
57218	27,00	18	8,5	0,6	2,00	1
57220	30,20	20	9,0	0,6	2,80	1
57224	38,90	24	9,5	0,7	4,25	1



Cazo recto alto

Casserole haute · Stielkasserolle, hoch
 Deep saucepan · Caçarola alta direite

Ref	€	Ø (cm)	h (cm)	e (mm)	L	U.Venta
57217	27,00	16	11,0	0,6	2,10	1
57219	31,40	18	12,0	0,6	3,00	1
57221	35,60	20	13,0	0,6	4,00	1
57225	49,00	24	15,0	0,7	6,50	1



Baño maría con fondo

Bahut avec fond · Bain marie Topf
 Double boiler with bottom · Banho-Maria com fundo

Ref	€	Ø (cm)	h (cm)	e (mm)	L	U.Venta
57717	31,70	16	16,0	0,7	3,20	1
57721	42,50	20	20,0	0,7	6,20	1



Sauteux

Sauteuse · Sauteuse
 Sauteuse · Frigideira

Ref	€	Ø (cm)	h (cm)	e (mm)	L	U.Venta
57625	35,60	24	6,5	0,7	2,70	1
57629	53,90	28	6,5	0,7	4,00	1

CHEF-ALUMINIO

Batería



Aluminio puro (99,5%)
Made in pure aluminium (99,5%)

ES

- Cuerpo fabricado en aluminio puro (99,5%).
- Asas y mangos atérmicos en tubo de acero inoxidable 18/10.
- Espesor 2,5 - 5 mm.
- Tapas diseñadas para el ahorro energético.
- Apta para todos los tipos de cocina (excepto inducción).
- Acabado mate interior y exterior mate lijado.
- Máxima garantía en cuanto a resistencia, durabilidad e higiene.

FR

- Corps fabriqué en aluminium pur (99,5%).
- Poignées et manches athermiques en tube d'acier inoxydable 18/10.
- Épaisseur 2,5 - 5 mm.
- Couvercles conçus pour une économie d'énergie.
- Compatible avec tous les types de cuisinières (excepté l'induction).
- Finition intérieur mate et extérieur mate polie.
- Garantie maximale en termes de résistance, de durabilité et d'hygiène.

EN

- Body made in pure (99.5%) aluminium.
- Heatproof handles and grips in a 18/10 stainless steel tube.
- Thickness 2.5 - 5 mm.
- Covers designed for saving energy.
- Suitable for all types of cooking surfaces (except induction).
- Interior matte finish and exterior sanded matte finish.
- Maximum guarantee in terms of resistance, durability and hygiene.



Cacerola con tapa

Braisiere a/couvercle · Bratentopf mit Deckel
Casserole with lid · Caçarola com tampa

Ref	€	Ø (cm)	h (cm)	e (mm)	L	U.Venta
20020	48,70	20	8,0	2,5	2,50	1
20024	54,30	24	9,5	2,5	4,30	1
20028	65,40	28	11,0	2,5	6,75	1
20030	70,30	30	11,5	2,5	8,15	1
20032	75,20	32	12,0	2,5	9,65	1
20034	81,70	34	13,0	3,0	11,80	1
20036	86,70	36	14,0	3,0	14,25	1
20038	97,20	38	15,0	3,0	17,00	1
20040	102,50	40	16,0	3,0	21,10	1
20045	122,40	45	18,0	3,5	28,00	1
20050	146,40	50	21,0	3,5	41,00	1
20060	208,50	60	25,0	4,5	70,00	1



Cacerola alta con tapa

Braisiere avec couvercle · Fleischtopf mit Deckel
Deep casserole with lid · Caçarola alta com tampa

Ref	€	Ø (cm)	h (cm)	e (mm)	L	U.Venta
20021	53,00	20	13,0	2,5	4,10	1
20025	60,80	24	15,0	2,5	6,80	1
20029	70,20	28	17,0	2,5	10,45	1
20031	76,60	30	18,0	2,5	12,70	1
20033	88,80	32	19,0	3,0	15,25	1
20035	95,70	34	21,0	3,0	18,05	1
20037	98,00	36	22,0	3,0	22,40	1
20039	106,30	38	23,0	3,0	26,10	1
20041	122,40	40	25,0	3,5	31,40	1
20046	139,90	45	28,0	4,5	45,00	1
20051	185,60	50	31,0	4,5	60,00	1
20061	246,20	60	37,0	4,5	104,00	1



Olla recta con tapa

Marmite traiteur a/couvercle · Suppentopf mit Deckel
Stock pot with lid · Panela com tampa

Ref	€	Ø (cm)	h (cm)	e (mm)	L	U.Venta
20120	60,30	20	20,0	2,5	6,30	1
20124	70,30	24	24,0	2,5	10,85	1
20128	88,40	28	28,0	3,0	17,25	1
20130	96,80	30	30,0	3,0	21,20	1
20132	106,50	32	32,0	3,0	25,75	1
20134	117,80	34	34,0	3,5	30,90	1
20136	126,70	36	36,0	3,5	36,65	1
20138	135,50	38	38,0	3,5	43,10	1
20140	151,90	40	40,0	4,0	50,30	1
20145	187,40	45	45,0	4,5	72,00	1
20150	211,10	50	50,0	4,5	100,00	1
20160	307,90	60	55,0	5,0	155,50	1



Paellera

Plat rond · Pflanne
Round · Paelheira

Ref	€	Ø (cm)	h (cm)	e (mm)	L	U.Venta
20628	41,80	28	7,0	2,5	4,30	1
20630	44,40	30	6,5	2,5	4,75	1
20632	47,50	32	7,0	2,5	5,50	1
20634	50,20	34	7,0	2,5	6,35	1
20636	53,10	36	7,5	2,5	7,45	1
20638	53,90	38	7,5	3,0	8,60	1
20640	63,40	40	8,0	3,0	10,05	1
20645	69,30	45	8,0	3,0	12,50	1
20650	80,80	50	8,0	3,0	15,50	1
20660	115,50	60	10,0	3,5	28,00	1



Cazo recto

Casserole · Stielkasserolle, flach
Saucepan · Caçarola direita

Ref	€	Ø (cm)	h (cm)	e (mm)	L	U.Venta
20216	27,20	16	7,0	2,5	1,40	1
20220	32,50	20	8,0	2,5	2,50	1
20224	37,00	24	9,5	2,5	4,30	1
20228	43,90	28	11,0	2,5	6,80	1



Cazo recto alto

Casserole haute · Stielkasserolle, hoch
Deep saucepan · Caçarola alta direita

Ref	€	Ø (cm)	h (cm)	e (mm)	L	U.Venta
20217	32,10	16	11,0	2,5	2,20	1
20221	37,30	20	13,0	2,5	4,10	1
20225	43,40	24	15,0	2,5	6,80	1
20229	50,20	28	17,0	2,5	10,50	1



Cazo bombado

Casserole bombée · Kasserolle, Bauchig
Rounded saucepan · Caçarola bojuda

Ref	€	Ø (cm)	h (cm)	e (mm)	L	U.Venta
21216	27,40	16	8,0	2,5	1,50	1
21220	32,80	20	10,0	2,5	2,50	1
21224	38,80	24	12,0	2,5	4,00	1
21228	45,90	28	14,0	2,5	6,50	1



Pote cilíndrico

Pot-cilindrique · Milchtopf
Cylindrical pot · Caneca cilíndrica

Ref	€	Ø (cm)	h (cm)	e (mm)	L	U.Venta
20716	34,50	16	16,0	2,5	3,20	1
20720	40,50	20	20,0	2,5	6,30	1



Rustidera con asas abatibles

Plat à rotir anse tombante · Bratpfanne mit Fallgriffen
Roaster moving handle · Assadeira com asa abatível

Ref	€	cm	h (cm)	e (mm)	L	U.Venta
20540A	53,90	40x30	6,2	2,5	7,45	1
20545A	57,80	45x32	6,2	2,5	10,40	1
20550A	72,60	50x35	7,0	3,0	12,60	1
20555A	78,80	55x37	7,7	3,0	16,30	1
20560A	84,70	60x40	7,7	3,0	18,95	1
20565A	94,80	65x43	7,9	3,0	24,30	1
20570A	100,30	70x45	9,0	3,0	28,65	1



Rustidera con asas fijas

Plat à rotir anse fixe · Bratpfanne, m. feststehenden Griffen
Roaster fix handle · Assadeira com asa fixa

Ref	€	cm	h (cm)	e (mm)	L	U.Venta
20540F	53,90	40x30	6,2	2,5	7,45	1
20545F	57,80	45x32	6,2	2,5	10,40	1
20550F	72,60	50x35	7,0	3,0	12,60	1
20555F	78,80	55x37	7,7	3,0	16,30	1
20560F	85,30	60x40	7,7	3,0	18,95	1
20565F	94,80	65x43	7,9	3,0	24,30	1
20570F	100,30	70x45	9,0	3,0	28,65	1



Hervidor de pescado

Poissonnière avec grille · Fischkessel mit Einsatz
Fish kettle with grill and lid · Peixeira

Ref	€	cm	h (cm)	e (mm)	L	U.Venta
20470	203,80	70x22	20,80	2,5	14,0	1



Bandeja horno

Plaque à four · Backblech
Oven tray · Bandeja forno

Ref	€	cm	h (cm)	e (mm)	U.Venta
20551	40,50	50x35	2,0	2,5	1
20561	49,40	60x40	2,0	2,5	1



Tapa

Couvercle · Deckel
Lid · Tampa

Ref	€	Ø (cm)	U.Venta
20920	14,50	20	1
20924	15,50	24	1
20928	18,80	28	1
20930	19,60	30	1
20932	21,70	32	1
20934	22,20	34	1
20936	23,80	36	1
20938	24,80	38	1
20940	27,60	40	1
20945	30,10	45	1
20950	35,80	50	1
20960	42,20	60	1

Baterias domésticas
Household cookware

COMBI Colección



New

ES

- Fabricadas en acero inoxidable 18/10 de la mejor calidad.
- Máxima garantía en cuanto a resistencia, durabilidad e higiene.
- Acabado interior y exterior lijado satinado.
- Antiadherente QuanTanium® reforzado con partículas de titanio; libre de materiales tóxicos y pesados, ecológico y libre de PFOA
- Fondo termodifusor sandwich (inox 18/10 - aluminio - inoxidable).
- Distribución rápida y uniforme del calor.
- Aptas para todos los fuegos (incluido inducción y horno).
- Asas/mangos extraíbles fabricadas en baquelita termo-resistente. Disponibles en tres colores.
- Ahorra espacio de almacenaje.

FR

- Fabriquées en acier inoxydable 18/10 de la meilleure qualité.
- Garantie maximale en termes de résistance, de durabilité et d'hygiène.
- Marquage des contenances à l'intérieur (litres).
- Finition intérieure et extérieure en polissage satiné.
- Revêtement antiadhésif QuanTanium® renforcé par des particules de titane; exempt de matériaux toxiques et lourds, respectueux de l'environnement et sans PFOA.
- Fond thermodiffuseur sandwich (inox 18/10 - aluminium - inoxydable).
- Distribution rapide et uniforme de la chaleur.
- Aptes pour tous les types de feux (y compris l'induction et le four).
- Poignées / manches amovibles fabriqué en bakélite thermo-isolante. Disponible en trois couleurs.
- Économie d'espace de stockage.

EN

- Manufactured with the highest quality 18/10 stainless steel.
- Maximum guarantee in terms of resistance, durability and hygiene.
- Capacity markings on the inside (litres).
- Glossy sanded interior and exterior finish
- QuanTanium® non-stick reinforced with titanium particles; free from toxic and heavy materials, environmentally friendly and PFOA-free.
- Heat-diffusing sandwiched base (18/10 stainless steel - aluminium - st. Steel)
- Quick and even heat distribution.
- Suitable for all types of cookers (including induction hobs and ovens).
- Handles / grips made in heat resistant bakelite. Available in three colours.
- Saves storage space.

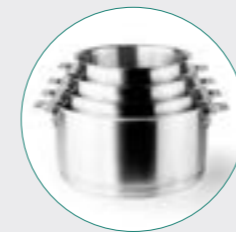

Apilables:
ahorra espacio de almacenamiento
Empilables:
elle permet de gagner de l'espace de rangement.
Stackable: save storage space



Sistema Click&Lock:
Mango y asas desmontables
Système Click&Lock:
Poignées et manches démontable
Click&Lock system:
Detachable handles and grips



Tapa de cristal resistente a los golpes con válvula y borde de acero inoxidable 18/10
Couvercle en verre avec soupape résistante aux chocs et bord en acier inoxydable 18/10
Glass cover with pressure valve resistant to bumps and 18/10 stainless steel rim



Cuerpo para cacerola/cazo

Corps pour faitout/casserole · Körper für Bratentopf/Stielkasserolle
Body for casserole/saucepan · Corpo para caçarola/caçarola direita

Ref	€	Ø (cm)	h (cm)	L	U.Venta
56614	21,50	14	7,0	1,00	1
56616	24,70	16	8,0	1,50	1
56618	28,50	18	9,0	2,00	1
56620	32,40	20	10,0	3,00	1
56624	43,70	24	12,0	5,50	1



Cuerpo para tartera/sartén

Corps pour plat rond/poêle · Körper für Pfanne/Pfanne
Body for round dish/frying pan · Corpo para tarteira/sertã

Ref	€	Ø (cm)	h (cm)	L	U.Venta
56720	23,70	20	4,0	1,00	1
56724	29,40	24	4,5	2,00	1
56728	39,90	28	5,0	3,00	1
56732	47,60	32	5,5	4,00	1



Cuerpo para tartera/sartén

Corps pour plat rond/poêle · Körper für Pfanne/Pfanne
Body for round dish/frying pan · Corpo para tarteira/sertã

Ref	€	Ø (cm)	h (cm)	L	U.Venta
56820	30,90	20	4,0	1,00	1
56824	37,40	24	4,5	2,00	1
56828	49,70	28	5,0	3,00	1
56832	57,70	32	5,5	4,00	1



Tapa

Couvercle · Deckel
Lid · Tampa

Ref	€	Ø (cm)	U.Venta
56914	16,40	14	1
56916	17,00	16	1
56918	17,80	18	1
56920	18,70	20	1
56924	20,00	24	1
56928	20,60	28	1
56932	21,50	32	1

Asa fabricada en baquelita termo-resistente
Poignée fabriqué en bakélite thermo-isolante
Handle made in heat resistant bakelite



Asa

Poignée · Griff
Handle · Asa

Ref	€	Color	U.Venta
A 56600	13,00	Negro · Black	1
B 56604	13,30	Azul · Blue	1
C 56602	13,30	Rojo · Red	1

Mango fabricado en baquelita termo-resistente
Manche fabriqué en bakélite thermo-isolante
Grip made in heat resistant bakelite



Mango

Poignée · Griff
Handle · Cabo

Ref	€	Color	U.Venta
A 56601	14,20	Negro · Black	1
B 56605	14,40	Azul · Blue	1
C 56603	14,40	Rojo · Red	1

ORIGIN

Colección



New

ES

- Fabricadas en acero inoxidable 18/10 de la mejor calidad.
- Asas fabricadas en acero inoxidable con recubrimiento PVD (proceso de chapado iónico con titanio, metal de gran dureza).
- Tapa fabricada en vidrio templado con válvula de salida de vapor y aro protector de acero inoxidable con recubrimiento PVD.
- Máxima garantía en cuanto a resistencia, durabilidad e higiene.
- Marcaje de capacidades en el interior (litros).
- Fondo termodifusor sandwich (inox 18/10 - aluminio - inoxidable).
- Distribución rápida y uniforme del calor.
- Apta para todos los fuegos (incluido inducción y horno) . Apta para el lavavajillas.

FR

- Fabriquées en acier inoxydable 18/10 de la meilleure qualité.
- Poignées en acier inoxydable avec revêtement PVD (procédé de placage ionique avec du titane, métal de haute dureté).
- Couvercle en verre trempé avec soupape d'évacuation de la vapeur et anneau de protection en acier inoxydable revêtu de PVD
- Garantie maximale en termes de résistance, de durabilité et d'hygiène.
- Marquage des contenances à l'intérieur (litres).
- Fond thermodiffuseur sandwich (inox 18/10 - aluminium - inoxydable).
- Distribution rapide et uniforme de la chaleur.
- Apte pour tous les types de feux (y compris l'induction et le four). Aptes pour le lave-vaisselle.

EN

- Maximum guarantee in resistance, durability and hygiene.
- Handles made of stainless steel with PVD coating (ionic plating process with titanium, high hardness metal).
- Lid made of tempered glass with steam outlet valve and protective ring made of PVD-coated stainless steel
- Maximum guarantee in terms of resistance, durability and hygiene.
- Capacity markings on the inside (litres).
- Heat-diffusing sandwiched base (18/10 stainless steel - aluminium - st. Steel).
- Quick and even heat distribution.
- Suitable for all types of cookers (including induction hobs and ovens). Dishwasher safe.



Recubrimiento PVD
PVD coating

Proceso de chapado iónico con titanio, metal de gran dureza
Ionic plating process with titanium, high hardness metal



Tapa fabricada en vidrio templado
Lid made of tempered glass

Aro protector de acero inoxidable con recubrimiento PVD
Protective ring made of PVD-coated stainless steel



Distribución rápida y uniforme del calor
Quick and even heat distribution

Fondo termodifusor sandwich (inox 18/10 - aluminio - inoxidable)
Heat-diffusing sandwiched base (18/10 stainless steel - aluminium - st. Steel).



Cacerola con tapa

Faitout avec couvercle · Bratentopf mit Deckel
Casserole with lid · Caçarola com tampa

Ref	€	Ø (cm)	h (cm)	L	U.Venta
47020	48,90	20	10	3,00	1
47024	57,20	24	12	5,20	1
47028	66,90	28	14	8,30	1



Cacerola baja con tapa

Faitout bas avec couvercle · Bratentopf mit Deckel
Low casserole with lid · Caçarola baixa com tampa

Ref	€	Ø (cm)	h (cm)	L	U.Venta
47128	61,40	28	8	4,70	1



Cazo recto

Casserole · Stielkasserolle, flach
Saucepan · Caçarola direite

Ref	€	Ø (cm)	h (cm)	L	U.Venta
47214	25,30	14	7	1,00	1
47216	27,70	16	8	1,50	1
47218	30,40	18	9	2,10	1
47220	34,30	20	10	3,00	1



Tapa

Couvercle · Deckel
Lid · Tampa

Ref	€	Ø (cm)	U.Venta
47620	15,30	20	1
47624	16,60	24	1
47628	18,40	28	1

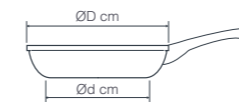

Sartén

Poêle · Pflanne
Frying pan · Sertã

Ref	€	ØD (cm)	Ød (cm)	h (cm)	e (mm)	U.Venta
47318	24,30	18	12,5	4,00	0,6	1
47320	27,10	20	12,8	4,20	0,6	1
47322	29,20	22	16,8	4,40	0,6	1
47324	31,10	24	18,5	4,60	0,6	1
47328	34,80	28	21,2	4,80	0,6	1
47330	37,80	30	23,0	5,00	0,6	1

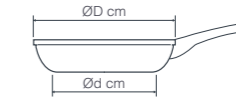

Sartén antiadherente

Poêle antiadherent · Pflanne, Antihafit
Frying-pan, non-stick · Sertã anti-aderente

Ref	€	ØD (cm)	Ød (cm)	h (cm)	e (mm)	U.Venta
47418	28,80	18	12,5	4,00	0,6	1
47420	31,90	20	12,8	4,20	0,6	1
47422	34,30	22	16,8	4,40	0,6	1
47424	36,50	24	18,5	4,60	0,6	1
47428	41,40	28	21,2	4,80	0,6	1
47430	45,10	30	23,0	5,00	0,6	1

FOODIE Colección



Marcaje de capacidades en el interior (litros)
Capacity markings on the inside (litres)

ES

- Fabricadas en acero inoxidable 18/10 de la mejor calidad.
- Asas y mangos ergonómicos de acero inoxidable fundido.
- Máxima garantía en cuanto a resistencia, durabilidad e higiene.
- Acabado interior y exterior lijado satinado.
- Marcaje de capacidades en el interior (litros).
- Fondo termodifusor sandwich (inox 18/10 - aluminio - inoxidable).
- Distribución rápida y uniforme del calor.
- Aptas para todos los fuegos (incluido inducción y horno).

FR

- Fabriquées en acier inoxydable 18/10 de la meilleure qualité.
- Poignées et manches ergonomiques en acier inoxydable fondu.
- Garantie maximale en termes de résistance, de durabilité et d'hygiène.
- Finition intérieure et extérieure en polissage satiné.
- Marquage des contenances à l'intérieur (litres).
- Fond thermodiffuseur sandwich (inox 18/10 - aluminium - inoxydable).
- Distribution rapide et uniforme de la chaleur.
- Aptes pour tous les types de feux (y compris l'induction et le four).

EN

- Maximum guarantee in resistance, durability and hygiene.
- Ergonomic handles and grips made of cast st. steel.
- Maximum guarantee in terms of resistance, durability and hygiene.
- Glossy sanded interior and exterior finish.
- Capacity markings on the inside (litres).
- Heat-diffusing sandwiched base (18/10 stainless steel - aluminium - st. Steel).
- Quick and even heat distribution.
- Suitable for all types of cookers (including induction hobs and ovens).



Cacerola con tapa

Faitout avec couvercle · Bratentopf mit Deckel
Casserole with lid · Caçarola com tampa

Ref	€	Ø (cm)	h (cm)	L	U.Venta
45016	45,70	16	7,5	1,50	1
45018	49,60	18	8,5	2,00	1
45020	54,20	20	9,5	3,00	1
45022	61,60	22	10,5	4,00	1
45024	67,90	24	11,5	5,00	1
45026	75,10	26	12,5	6,50	1
45028	81,20	28	12,5	7,50	1



Olla con tapa

Marmite avec couvercle · Fleichtopf mit Deckel
Stock pot with lid · Panela com tampa

Ref	€	Ø (cm)	h (cm)	L	U.Venta
45116	50,30	16	13,0	2,50	1
45118	53,80	18	14,0	3,50	1
45120	60,80	20	15,5	4,80	1
45122	66,20	22	15,5	5,50	1
45124	73,70	24	16,0	7,00	1
45126	80,60	26	16,0	8,00	1
45128	91,50	28	17,0	10,00	1



Cazo recto

Casserole · Stielkasserolle, flach
Saucepan · Caçarola direite

Ref	€	Ø (cm)	h (cm)	L	U.Venta
45214	32,80	14	7,5	1,00	1
45216	35,30	16	7,5	1,50	1
45218	39,40	18	8,5	2,00	1
45220	44,70	20	9,5	3,00	1



Tapa

Couvercle · Deckel
Lid · Tampa

Ref	€	Ø (cm)	U.Venta
45916	12,30	16	1
45918	12,90	18	1
45920	13,90	20	1
45922	15,00	22	1
45924	16,50	24	1
45926	17,60	26	1
45928	19,50	28	1



Tartera con tapa

Plat rond avec couvercle · Pfanne mit Deckel
Round dish with lid · Tarteira com tampa

Ref	€	Ø (cm)	h (cm)	L	U.Venta
45624	62,50	24	6,5	2,80	1
45626	68,60	26	6,5	3,00	1
45628	74,20	28	6,5	4,00	1



Sartén

Poêle · Pfanne
Frying pan · Sertã

Ref	€	ØD (cm)	Ød (cm)	h (cm)	e (mm)	U.Venta
45420	29,60	20	13,5	5,5	0,6	1
45422	31,50	22	14,5	5,5	0,6	1 New
45424	35,30	24	17,5	6,0	0,6	1
45426	37,50	26	19,0	6,0	0,6	1 New
45428	41,50	28	19,5	6,5	0,6	1
45430	42,70	30	22,0	6,5	0,6	1 New



Sartén antiadherente

Poêle antiadherent · Pfanne, Antihäft
Frying-pan, non-stick · Sertã anti-aderente

Ref	€	ØD (cm)	Ød (cm)	h (cm)	e (mm)	U.Venta
45320	34,80	20	13,5	5,5	0,6	1
45322	36,10	22	14,5	5,5	0,6	1 New
45324	42,60	24	17,5	6,0	0,6	1
45326	43,70	26	19,0	6,0	0,6	1 New
45328	51,00	28	19,5	6,5	0,6	1
45330	52,20	30	22,0	6,5	0,6	1 New

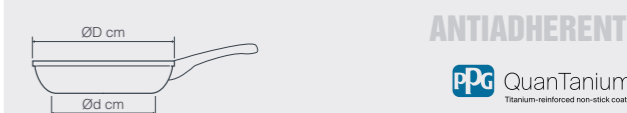

High release topcoat
Partially reinforced midcoat
Reinforced primer
(titanium-based particles)
Metal substrate

ANTIADHERENTE

PPG QuanTanium®
Titanium-reinforced non-stick coating

- Antiadherente QuanTanium® reforzado con partículas de titanio; libre de materiales tóxicos y pesados, ecológico y libre de PFOA.
- Antiadhésif QuanTanium® renforcé avec des particules de titane ; sans matériaux toxiques ni métaux lourds, écologique et sans PFOA.
- QuanTanium® non-stick reinforced with titanium particles; free from toxic and heavy materials, environmentally friendly and PFOA-free.

PROFESIONAL

Colección



ES

- Toda la pieza (cuerpo, asas y mangos) fabricada en acero inoxidable 18/10.
- Favorece una distribución rápida y homogénea del calor.
- Acabado pulido brillante exterior y lijado mate interior.
- Máxima garantía en cuanto a resistencia, durabilidad e higiene.
- Apta para todo tipo de cocinas (incluido inducción y horno).
- Fondo termodifusor sándwich (inox 18/10 - aluminio - inox).

FR

- Toute la pièce (corps, poignées et manches) est fabriquée en acier inoxydable 18/10.
- Favorise une distribution rapide et homogène de la chaleur.
- Finition extérieure polie brillante et intérieur polie mate.
- Garantie maximale en termes de résistance, de durabilité et d'hygiène.
- Compatible avec tout type de cuisinières (y compris induction et four).
- Fond thermo-diffuseur sandwich (inox 18/10 - aluminium - inox).

EN

- The whole product (body, handles and grips) is made in 18/10 stainless steel.
- It favours quick and homogeneous heat distribution.
- Exterior glossy, polished finish and sanded matte interior.
- Maximum guarantee in terms of resistance, durability and hygiene.
- Suitable for all types of cooking surfaces (including induction and the oven).
- Sandwich heat diffuser (18/10 stainless steel - aluminium - stainless steel).



Asas y mangos ergonómicos fabricados en acero inoxidable 18/10

Handles and grips are made in 18/10 stainless steel

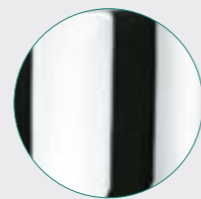

Acabado pulido brillante exterior y lijado mate interior

Exterior glossy, polished finish and sanded matte interior



Fondo termodifusor sandwich (inox 18/10 - aluminio - inoxidable)

Heat-diffusing sandwiched base (18/10 stainless steel - aluminium - st. Steel).

CARACTERÍSTICAS



Cacerola con tapa

Faitout a/couvercle · Bratentopf mit Deckel
Casserole with lid · Caçarola com tampa

Ref	€	Ø (cm)	h (cm)	L	U.Venta
72016	51,30	16	8,0	1,50	1
72020	59,90	20	8,5	2,50	1
72024	70,10	24	9,5	3,50	1
72028	89,80	28	11,0	6,50	1
72032	121,80	32	12,5	9,00	1



Olla super alta con tapa

Marmite S. Haute a/couvercle · Hoher Fleischtopf mit Deckel
Deep Stock pot with Lid · Panela super alta com tampa

Ref	€	Ø (cm)	h (cm)	L	U.Venta
72125	84,10	24	20,0	9,00	1
72129	110,10	28	22,0	13,50	1



Pote cilíndrico

Pot-cilindrique · Milchtopf
Cylindrical pot · Caneca cilíndrica

Ref	€	Ø (cm)	h (cm)	L	U.Venta
72714	32,30	14	12,5	1,50	1
72716	36,50	16	13,0	2,50	1



Olla con tapa

Marmite a/couvercle · Fleischtopf mit Deckel
Stock pot with Lid · Panela com tampa

Ref	€	Ø (cm)	h (cm)	L	U.Venta
72116	55,40	16	13,0	2,50	1
72120	64,00	20	14,5	4,50	1
72124	77,00	24	15,0	6,50	1
72128	100,10	28	17,0	10,00	1



Cazo recto

Casserole · Stielkasserole, flach
Saucepan · Caçarola direita

Ref	€	Ø (cm)	h (cm)	L	U.Venta
72214	27,50	14	7,5	1,00	1
72216	31,10	16	8,0	1,50	1
72218	33,40	18	8,5	2,00	1
72220	37,60	20	8,5	2,50	1



Tapa

Couvercle · Deckel
Lid · Tampa

Ref	€	Ø (cm)	U.Venta
72916	13,90	16	1
72918	14,60	18	1
72920	16,90	20	1
72924	19,50	24	1
72928	25,20	28	1
72932	27,30	32	1

BELLY

Colección



ES

- Toda la pieza (cuerpo y asas) fabricada en acero inoxidable 18/10.
- Máxima garantía en cuanto a resistencia, durabilidad e higiene.
- El diseño de cuerpos bombeados proporciona mayor capacidad.
- Marcaje de capacidades en el interior (litros).
- Fondo termodifusor sandwich (inox 18/10 - aluminio - inoxidable).
- Distribución rápida y uniforme del calor.
- Apta para todos los fuegos (incluido inducción y horno).
- Incluye tapa de cristal resistente a los golpes con válvula y borde de acero inoxidable 18/10.

FR

- Toute la pièce (corp et poignées) est fabriquée en acier inoxydable 18/10.
- Garantie max. en termes de résistance, de durabilité et d'hygiène.
- La forme bombée des corps confère une plus grande capacité.
- Marquage des contenances à l'intérieur (litres).
- Fond thermodiffuseur sandwich (inox 18/10 - aluminium - inoxydable).
- Distribution rapide et uniforme de la chaleur.
- Apte pour tous les types de feux (y compris l'induction et le four).
- Inclut un couvercle en verre avec soupape résistante aux chocs et bord en acier inoxydable 18/10.

EN

- The whole product (body and handles) is made in 18/10 st. steel.
- Max. guarantee in terms of resistance, durability and hygiene.
- Its rounded body provides greater capacity.
- Capacity markings on the inside (litres).
- Heat-diffusing sandwiched base (18/10 stainless Steel - aluminium - stainless Steel).
- Quick and even heat distribution.
- Suitable for all types of cookers (including induction hobs and ovens).
- It includes a glass cover with pressure valve resistant to bumps and 18/10 stainless steel rim.



Fondo Curvo
Proporciona mayor capacidad

Curved bottom
Provides greater capacity

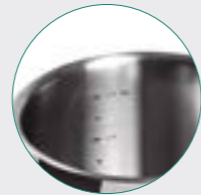

Marcajes de capacidad
en litros

Capacity markings inside
in litres



Tapa de cristal resistente a golpes con válvula y borde de acero inoxidable 18/10

Glass cover with pressure valve resistant to bumps and 18/10 stainless steel rim



Cacerola con tapa

Faitout avec couvercle · Bratentopf mit Deckel
Casserole with lid · Caçarola com tampa

Ref	€	Ø (cm)	h (cm)	L	U.Venta
79016	40,00	16	8,5	1,20	1
79020	54,30	20	9,5	2,50	1
79024	74,00	24	11,5	4,40	1
79028	97,20	28	15,0	8,20	1



Olla con tapa

Marmite avec couvercle · Fleischtopf mit Deckel
Stock pot with Lid · Panela com tampa

Ref	€	Ø (cm)	h (cm)	L	U.Venta
79116	44,70	16	10,0	1,60	1
79120	61,40	20	12,0	3,50	1
79124	78,80	24	14,0	5,50	1
79128	104,30	28	17,0	9,50	1



Cazo recto

Casserole · Stielkasserole, flach
Saucepan · Caçarola direite

Ref	€	Ø (cm)	h (cm)	L	U.Venta
79214	28,00	14	9,0	1,20	1
79216	32,70	16	9,5	1,60	1
79218	37,10	18	10,5	2,50	1
79220	42,80	20	11,5	3,50	1



Cacerola vapor

Panier vapeur · Dampfkoch-Aufsatz
Steam casserole · Caçarola a vapor

Ref	€	Ø (cm)	h (cm)	L	U.Venta
79420	34,80	20	9,5	3,00	1
79424	46,40	24	12,0	4,50	1



Tartera con tapa

Plat rond avec couvercle · Pfanne mit Deckel
Round dish with lid · Tarteira com tampa

Ref	€	Ø (cm)	h (cm)	L	U.Venta
79624	61,60	24	7,5	2,60	1
79628	78,30	28	7,5	3,0	1



Pote

Pot · Milchtopf
Pot · Caneca

Ref	€	Ø (cm)	h (cm)	L	U.Venta
79714	28,00	14	11,0	1,50	1



Wok

Wok · Wok
Wok · Wok

Ref	€	Ø (cm)	h (cm)	L	U.Venta
79830	62,80	30	10,0	4,50	4



Tapa

Couvercle · Deckel
Lid · Tampa

Ref	€	Ø (cm)	U.Venta
79916	12,80	16	1
79920	17,10	20	1
79924	21,20	24	1
79928	26,70	28	1

VITROCOR

Colección



ES

- Toda la pieza (cuerpo, asas y mangos) fabricada en acero inoxidable 18/10.
- Favorece una distribución rápida y homogénea del calor.
- Destaca por su diseño clásico, funcionalidad y sencillez.
- Acabado pulido brillante exterior y lijado mate interior.
- Apta para todo tipo de cocinas (incluido inducción y horno).
- Fondo termodifusor sándwich (inox 18/10 - aluminio - inox).
- Apta para el lavavajillas.

FR

- Toute la pièce (corps, poignées et manches) est fabriquée en acier inoxydable 18/10.
- Favorise une distribution rapide et homogène de la chaleur.
- Se distingue par son style classique, sa fonctionnalité et sa simplicité.
- Finition extérieure polie brillante et intérieur limage mat.
- Compatible avec tout type de cuisinières (y compris induction et four).
- Fond thermo-diffuseur sandwich (inox 18/10 - aluminium - inox).
- Apte pour le lave-vaisselle.

EN

- The whole product (body, handles and grips) is made in 18/10 stainless steel.
- It favours quick and homogeneous heat distribution.
- Stands out for its classic design, functionality and simplicity.
- Exterior glossy, polished finish and sanded matte interior.
- Suitable for all types of cooking surfaces (including induction and the oven).
- Sandwich heat diffuser (18/10 stainless steel - aluminium - stainless steel).
- Dishwasher safe.



Cacerola con tapa

Faitout avec couvercle · Bratentopf mit Deckel
Casserole with lid · Caçarola com tampa

Ref	€	Ø (cm)	h (cm)	L	U.Venta
40016	39,20	16	8,0	1,50	1
40018	42,70	18	8,5	2,00	1
40020	47,20	20	8,5	2,50	1
40022	51,80	22	9,0	3,00	1
40024	55,40	24	9,5	3,50	1
40026	62,80	26	9,5	4,50	1
40028	80,40	28	11,0	6,50	1
40032	101,30	32	12,5	9,50	1
40036	137,80	36	14,0	14,20	1
40040	159,90	40	15,5	19,50	1



Olla con tapa

Marmite avec couvercle · Fleischtopf mit Deckel
Stock pot with Lid · Panela com tampa

Ref	€	Ø (cm)	h (cm)	L	U.Venta
40116	44,10	16	13,0	2,50	1
40118	47,10	18	14,0	3,50	1
40120	51,40	20	14,5	4,50	1
40122	57,00	22	14,5	5,50	1
40124	64,00	24	15,0	6,50	1
40126	69,60	26	15,0	7,50	1
40128	88,00	28	17,0	10,00	1
40132	106,30	32	17,5	13,50	1
40136	150,70	36	21,5	22,00	1
40140	183,70	40	24,5	30,80	1



Olla super alta con tapa

Marmite S. Haute a/couvercle · Hoher Fleischtopf mit Deckel
Deep Stock pot with Lid · Panela super alta com tampa

Ref	€	Ø (cm)	h (cm)	L	U.Venta
40121	56,20	20	17,5	5,50	1
40125	73,10	24	20,0	9,00	1
40129	98,00	28	22,0	13,50	1
40133	145,10	32	28,0	22,50	1



Cacerola vapor

Panier vapeur · Dampfkoch-Aufsatz
Steam casserole · Caçarola a vapor

Ref	€	Ø (cm)	h (cm)	L	U.Venta
40420	35,00	20	8,5	2,50	1
40424	44,10	24	9,5	3,50	1
40428	48,40	28	11,0	6,50	1



Pote cilíndrico

Pot-cilindrique · Milchtopf
Cylindrical pot · Caneca cilíndrica

Ref	€	Ø (cm)	h (cm)	L	U.Venta
40712	29,00	12	12,0	1,00	1
40714	31,00	14	12,5	1,50	1
40716	34,10	16	13,0	2,50	1
40718	37,70	18	14,0	3,50	1



Tapa

Couvercle · Deckel
Lid · Tampa

Ref	€	Ø (cm)	U.Venta
40916	10,60	16	1
40918	10,80	18	1
40920	11,40	20	1
40922	12,10	22	1
40924	13,30	24	1
40926	14,20	26	1
40928	17,90	28	1
40932	22,40	32	1
40936	30,00	36	1
40940	34,10	40	1



Escurridera · Colador esférico

Passoire sur pied · Abtropfschüssel
Colander with stand · Escorredor

Ref	€	Ø (cm)	h (cm)	U.Venta
40318	31,30	19	8,5	1
40324	48,90	24	11,0	1



Cazo recto

Casserole · Stielkasserole, flach
Saucepan · Caçarola direita

Ref	€	Ø (cm)	h (cm)	L	U.Venta
40212	24,60	12	7,0	0,80	1
40214	25,50	14	7,5	1,00	1
40216	28,90	16	8,0	1,50	1
40218	31,50	18	8,5	2,00	1
40220	36,60	20	8,5	2,50	1



Tartera con tapa

Plat rond avec couvercle · Pflanne mit Deckel
Round dish with lid · Tarteira com tampa

Ref	€	Ø (cm)	h (cm)	L	U.Venta
40620	47,10	20	6,5	2,00	1
40622	50,10	22	6,5	2,50	1
40624	55,20	24	7,0	3,00	1
40626	59,80	26	7,0	3,50	1
40628	74,60	28	8,0	4,50	1
40632	90,50	32	8,0	6,00	1
40636	120,00	36	8,5	7,50	1
40640	138,70	40	8,5	11,00	1



Sartén

Poêle · Pflanne
Frying pan · Sertã

Ref	€	Ø (cm)	h (cm)	e (mm)	U.Venta
40619	32,90	18	4,5	0,7	1
40621	35,00	20	4,5	0,7	1
40623	36,30	22	5,0	0,7	1
40625	38,80	24	5,2	0,7	1
40627	40,00	26	6,0	0,7	1
40629	42,90	28	6,5	0,7	1



Cuecepastas sin tapa

Cuit-pâte sans couvercle · Nudelkoch-Einsatz ohne Deckel
Casserole without lid · Coze-massas sem tampa

Ref	€	Ø (cm)	h (cm)	L	U.Venta
40426	66,50	24	17,5	9,50	1

GOURMET

Colección



ES

- Favorece una distribución rápida y homogénea del calor.
- Extremadamente robustos.
- Acabado pulido brillante exterior y lijado mate interior.
- Apta para todo tipo de cocinas (incluido inducción y horno).
- Triple fondo difusor que asegura un eficiente reparto del calor.

FR

- Toute la pièce (corps, poignées et manches) est fabriquée en acier inoxydable 18/10.
- Favorise une distribution rapide et homogène de la chaleur.
- Extrêmement robustes.
- Finition extérieure polie brillante et intérieur limage mat.
- Compatible avec tout type de cuisinières (y compris induction et four).
- Triple fond diffuseur qui garantit une répartition efficace de la chaleur.

EN

- The whole product (body, handles and grips) is made in 18/10 stainless steel.
- It favours quick and homogeneous heat distribution.
- Extremely robust.
- Exterior glossy, polished finish and sanded matte interior.
- Suitable for all types of cooking surfaces (including induction and the oven).
- Triple diffuser bottom assuring efficient distribution of heat.



Cacerola con tapa

Faitout avec couvercle · Bratentopf mit Deckel
Casserole with lid · Caçarola com tampa

Ref	€	Ø (cm)	h (cm)	L	U.Venta
90016	43,60	16	8,0	1,50	1
90018	46,70	18	8,5	2,00	1
90020	51,30	20	8,5	2,50	1
90022	55,60	22	9,0	3,00	1
90024	60,10	24	9,5	3,50	1
90026	67,40	26	9,5	4,50	1
90028	82,70	28	11,0	6,50	1
90032	102,80	32	12,5	9,50	1



Olla con tapa

Marmite avec couvercle · Fleischtopf mit Deckel
Stock pot with Lid · Panela com tampa

Ref	€	Ø (cm)	h (cm)	L	U.Venta
90116	47,80	16	13,0	2,50	1
90118	51,70	18	14,0	3,50	1
90120	54,80	20	14,5	4,50	1
90122	61,00	22	14,5	5,50	1
90124	67,60	24	15,0	6,50	1
90126	72,90	26	15,0	7,50	1
90128	90,60	28	17,0	10,00	1
90132	117,40	32	17,5	13,50	1



Olla super alta con tapa

Marmite S. Haute a/couvercle · Hoher Fleischtopf mit Deckel
Deep Stock pot with Lid · Panela super alta com tampa

Ref	€	Ø (cm)	h (cm)	L	U.Venta
90125	77,60	24	20,0	9,00	1
90129	100,70	28	22,0	13,50	1



Cacerola vapor

Panier vapeur · Dampfkoch-Aufsatz
Steam casserole · Caçarola a vapor

Ref	€	Ø (cm)	h (cm)	L	U.Venta
90420	39,70	20	8,5	2,50	1
90424	48,80	24	9,5	3,50	1



Tartera con tapa

Plat rond a/couvercle · Pfanne mit Deckel
Round dish with lid · Tarteira com tampa

Ref	€	Ø (cm)	h (cm)	L	U.Venta
90620	51,30	20	6,5	2,00	1
90622	54,90	22	6,5	2,50	1
90624	58,70	24	7,0	3,00	1
90626	63,60	26	7,0	3,50	1
90628	75,70	28	8,0	4,50	1
90632	94,20	32	8,0	6,00	1



Pote cilíndrico

Pot-cilindrique · Milchtopf
Cylindrical pot · Caneca cilíndrica

Ref	€	Ø (cm)	h (cm)	L	U.Venta
90712	29,60	12	12,0	1,00	1
90714	31,30	14	12,5	1,50	1
90716	35,20	16	13,0	2,50	1
90718	38,10	18	14,0	3,50	1



Cazo recto

Casserole · Stielkasserole, flach
Saucepan · Caçarola direita

Ref	€	Ø (cm)	h (cm)	L	U.Venta
90212	26,60	12	7,0	0,80	1
90214	28,10	14	7,5	1,00	1
90216	31,50	16	8,0	1,50	1
90218	34,10	18	8,5	2,00	1
90220	38,20	20	8,5	2,50	1



Colador esférico

Passoire à queue · Seiher, mit Stiel
Strainer · Colador esférico

Ref	€	Ø (cm)	h (cm)	U.Venta
90318	31,30	18	8,5	1



Escurridera

Passoire sur pied · Abtropfschüssel
Colander with stand · Escorredor

Ref	€	Ø (cm)	h (cm)	U.Venta
90324	47,40	24	11,0	1



Tapa

Couvercle · Deckel
Lid · Tampa

Ref	€	Ø (cm)	U.Venta
90916	11,70	16	1
90918	11,70	18	1
90920	11,80	20	1
90922	12,00	22	1
90924	13,20	24	1
90926	14,20	26	1
90928	18,60	28	1
90932	24,00	32	1

BASIC

Colección



ES

- Toda la pieza (cuerpo, asas y mangos) fabricada en acero inoxidable.
- La tapa, con cierre de precisión, preserva los aromas y retiene el calor.
- Ideal para cocinar de forma saludable y ahorrar energía.
- Acabado interior lijado satinado y exterior pulido brillante.
- Apta para todo tipo de cocinas (incluido inducción y horno).
- Apta para el lavavajillas.

FR

- Toute la pièce (corps, poignées et manches) est fabriquée en acier inoxydable.
- Le couvercle, avec fermeture de précision, préserve les arômes et retient la chaleur.
- Idéal pour cuisiner sainement et réaliser des économies d'énergie.
- Finition intérieure limée satinée et extérieur polie brillante.
- Compatible avec tout type de cuisinières (y compris induction et four).
- Apte pour le lave-vaisselle.

EN

- The whole product (body, handles and grips) is made in stainless steel.
- The cover, with precision fit, retains the aromas and heat.
- Ideal for cooking healthy while saving energy.
- A sanded, satin interior finish and shiny, polished exterior.
- Suitable for all types of cooking surfaces (including induction and the oven).
- Dishwasher safe.



Cacerola con tapa

Faitout a/couvercle · Bratentopf mit Deckel
Casserole with lid · Caçarola com tampa

Ref	€	Ø (cm)	h (cm)	L	U.Venta
32016	32,40	16	8,0	1,50	1
32020	39,40	20	8,5	2,50	1
32024	48,90	24	9,5	3,50	1
32028	63,20	28	11,0	6,50	1



Olla con tapa

Marmite avec couvercle · Fleischtopf mit Deckel
Stock pot with Lid · Panela com tampa

Ref	€	Ø (cm)	h (cm)	L	U.Venta
32116	39,40	16	13,0	2,50	1
32120	43,70	20	13,5	4,50	1
32124	55,30	24	15,0	6,50	1
32128	71,90	28	17,0	10,00	1



Olla super alta con tapa

Marmite S. Haute a/couvercle · Hoher Fleischtopf mit Deckel
Deep Stock pot with Lid · Panela super alta com tampa

Ref	€	Ø (cm)	h (cm)	L	U.Venta
32125	67,80	24	20,0	9,00	1
32129	85,60	28	22,5	13,50	1



Cacerola vapor

Panier vapeur · Dampfkoch-Aufsatz
Steam casserole · Caçarola a vapor

Ref	€	Ø (cm)	h (cm)	L	U.Venta
32420	25,10	20	8,5	2,50	1
32424	29,40	24	9,5	3,50	1



Cazo recto

Casserole · Stielkasserole, flach
Saucepan · Caçarola direita

Ref	€	Ø (cm)	h (cm)	L	U.Venta
32214	19,20	14	7,5	1,00	1
32216	22,20	16	8,0	1,50	1
32218	24,60	18	8,5	2,00	1
32220	28,00	20	8,5	2,50	1



Tartera con tapa

Plat rond avec couvercle · Pfanne mit Deckel
Round dish with lid · Tarteira com tampa

Ref	€	Ø (cm)	h (cm)	L	U.Venta
32624	41,00	24	7,0	3,00	1
32628	57,50	28	8,0	4,50	1



Lote 4 cazos

Ensemble 4 casseroles · Set 4 Tlg. Stielkasserollen
Set 4 saucepans · Lote de 4 caçarola

Ref	€	U.Venta
32003	93,10	1



Pote cilíndrico

Pot-cilindrique · Milchtopf
Cylindrical pot · Caneca cilíndrica

Ref	€	Ø (cm)	h (cm)	L	U.Venta
32714	24,60	14	12,5	1,50	1
32716	28,80	16	13,0	2,50	1



Escurridera

Passoire sur pied · Abtropfschüssel
Colander with stand · Escorredor

Ref	€	Ø (cm)	h (cm)	U.Venta
32324	52,20	24	11,0	1



Colador esférico

Passoire à queue · Seiher, mit Stiel
Strainer · Coador esférico

Ref	€	Ø (cm)	h (cm)	U.Venta
32318	37,70	18	8,5	1



Tapa

Couvercle · Deckel
Lid · Tampa

Ref	€	Ø (cm)	U.Venta
32916	9,30	16	1
32920	11,20	20	1
32924	13,10	24	1
32928	16,40	28	1

NOVA-LADYCOR

Colección

Inox
18/10



ES

- Cuerpo fabricado en acero inoxidable 18/10.
- Asas, mangos y pomo en baquelita termoaislante.
- Destaca por su diseño clásico, funcionalidad y sencillez.
- Acabado pulido brillante exterior y lijado mate interior.
- Triple fondo difusor que asegura un eficiente reparto del calor.
- Apta para todo tipo de cocinas (incluido inducción).
- Apta para el lavavajillas.

FR

- Corps fabriqué en acier inoxydable 18/10.
- Poignées, manches et pommeau en bakélite thermo-isolante.
- Se distingue par son style classique, sa fonctionnalité et sa simplicité.
- Finition polie brillante extérieur et image mat intérieur.
- Triple fond diffuseur qui garantit une répartition efficace de la chaleur.
- Compatible avec tout type de cuisinières (y compris induction).
- Apte pour le lave-vaisselle.

EN

- Body made in 18/10 stainless steel.
- Handles, grips and knob in heat resistant bakelite.
- Stands out for its classic design, functionality and simplicity.
- Exterior glossy, polished finish and sanded matte interior.
- Triple diffuser bottom assuring efficient distribution of heat.
- Suitable for all types of cooking surfaces (including induction).
- Dishwasher safe.



Cacerola con tapa

Faitout avec couvercle · Bratentopf mit Deckel
Casserole with lid · Caçarola com tampa

Ref	€	Ø (cm)	h (cm)	L	U.Venta
88016	44,40	16	8,0	1,50	1
88018	47,50	18	8,5	2,00	1
88020	51,70	20	8,5	2,50	1
88022	56,60	22	9,0	3,00	1
88024	60,40	24	9,5	3,50	1
88026	67,70	26	9,5	4,50	1
88028	82,40	28	11,0	9,50	1
88032	104,80	32	12,5	9,50	1



Olla con tapa

Marmite avec couvercle · Fleischtopf mit Deckel
Stock pot with Lid · Panela com tampa

Ref	€	Ø (cm)	h (cm)	L	U.Venta
88116	48,90	16	13,0	2,50	1
88118	51,60	18	14,0	3,50	1
88120	55,20	20	14,5	4,50	1
88122	60,40	22	14,5	5,50	1
88124	67,50	24	15,0	6,50	1
88126	75,00	26	15,0	7,50	1
88128	91,30	28	17,0	10,00	1
88132	110,20	32	17,5	13,50	1



Olla super alta con tapa

Marmite S. Haute a/couvercle · Hoher Fleischtopf mit Deckel
Deep Stock pot with Lid · Panela super alta com tampa

Ref	€	Ø (cm)	h (cm)	L	U.Venta
88121	60,30	20	17,5	5,50	1
88125	76,70	24	20,0	9,00	1
88129	108,00	28	22,0	13,50	1



Cacerola vapor

Panier vapeur · Dampfkoch-Aufsatz
Steam casserole · Caçarola a vapor

Ref	€	Ø (cm)	h (cm)	L	U.Venta
88420	41,30	20	9,0	2,50	1
88424	50,70	24	10,5	3,50	1



Pote cilíndrico

Pot-cilindrique · Milchtopf
Cylindrical pot · Caneca cilíndrica

Ref	€	Ø (cm)	h (cm)	L	U.Venta
88712	28,90	12	12,0	1,00	1
88714	31,30	14	12,5	1,50	1
88716	34,20	16	13,0	2,50	1
88718	37,70	18	14,0	3,50	1



Colador esférico

Passoire à queue · Seiher, mit Stiel
Strainer · Coador esférico

Ref	€	Ø (cm)	h (cm)	U.Venta
88318	33,80	18	8,5	1



Escurridera

Passoire sur pied · Abtropfschüssel
Colander with stand · Escorredor

Ref	€	Ø (cm)	h (cm)	U.Venta
88324	47,80	24	11,0	1



Cazo recto

Casserole · Stielkasserole, flach
Saucepan · Caçarola direita

Ref	€	Ø (cm)	h (cm)	L	U.Venta
88212	26,40	12	7,0	0,80	1
88214	27,30	14	7,5	1,00	1
88216	30,00	16	8,0	1,50	1
88218	32,90	18	8,5	2,00	1
88220	37,70	20	8,5	2,50	1



Tartera con tapa

Plat rond avec couvercle · Pfanne mit Deckel
Round dish with lid · Tarteira com tampa

Ref	€	Ø (cm)	h (cm)	L	U.Venta
88620	51,30	20	6,5	2,00	1
88622	55,20	22	6,5	2,50	1
88624	59,20	24	7,0	3,00	1
88626	63,70	26	7,0	3,50	1
88628	72,50	28	8,0	4,50	1
88632	92,60	32	8,0	6,00	1



Tapa

Couvercle · Deckel
Lid · Tampa

Ref	€	Ø (cm)	U.Venta
88916	10,40	16	1
88918	10,60	18	1
88920	11,20	20	1
88922	11,50	22	1
88924	12,30	24	1
88926	13,80	26	1
88928	17,10	28	1
88932	23,40	32	1

ESTUDIO Colección



ES

- **Cuerpo fabricado en acero inoxidable 18/10.**
- **Asas, mangos y pomo en baquelita termoaislante.**
- **Su pomo abatible consigue una reducción del espacio manteniendo una ergonomía perfecta.**
- **Acabado pulido brillante exterior y lijado mate interior.**
- **Triple fondo difusor que asegura un eficiente reparto del calor.**
- **Apta para todo tipo de cocinas (incluido inducción).**
- **Apta para el lavavajillas.**

FR

- **Corps fabriqué en acier inoxydable 18/10.**
- **Poignées, manches et pommeau en bakélite thermo-isolante.**
- **Son pommeau rabattable permet un gain d'espace en conservant une ergonomie parfaite.**
- **Finition extérieur polie brillante et intérieur limage mat.**
- **Triple fond diffuseur qui garantit une répartition efficace de la chaleur.**
- **Compatible avec tout type de cuisinières (y compris induction).**
- **Apte pour le lave-vaisselle.**

EN

- **Body made in 18/10 stainless steel.**
- **Handles, grips and knob in heat resistant bakelite.**
- **Its folding knob reduces storage space maintaining ergonomic perfection.**
- **Exterior glossy, polished finish and sanded matte interior.**
- **Triple diffuser bottom assuring efficient distribution of heat.**
- **Suitable for all types of cooking surfaces (including induction).**
- **Dishwasher safe.**



Cacerola con tapa

Faitout avec couvercle · Bratentopf mit Deckel
Casserole with lid · Caçarola com tampa

Ref	€	Ø (cm)	h (cm)	L	U.Venta
85016	44,90	16	8,0	1,50	1
85018	48,40	18	8,5	2,00	1
85020	52,80	20	8,5	2,50	1
85022	56,70	22	9,0	3,00	1
85024	61,10	24	9,5	3,50	1
85026	66,70	26	9,5	4,50	1
85028	76,80	28	11,0	6,50	1



Olla con tapa

Marmite a/couvercle · Fleischtopf mit Deckel
Stock pot with Lid · Panela com tampa

Ref	€	Ø (cm)	h (cm)	L	U.Venta
85118	51,50	18	14,0	3,50	1
85120	56,60	20	14,5	4,50	1
85122	61,80	22	14,5	5,50	1
85124	67,70	24	15,0	6,50	1
85126	72,90	26	15,0	7,50	1
85128	86,10	28	17,0	10,00	1



Olla super alta con tapa

Marmite S. Haute a/couvercle 3 Hoher Fleischtopf mit Deckel
Deep Stock pot with Lid · Panela super alta com tampa

Ref	€	Ø (cm)	h (cm)	L	U.Venta
85125	77,00	24	20,0	9,00	1
85129	95,00	28	22,0	13,50	1



Cacerola vapor

Panier vapeur · Dampfkoch-Aufsatz
Steam casserole · Caçarola a vapor

Ref	€	Ø (cm)	h (cm)	L	U.Venta
85420	39,60	20	9,0	2,50	1
85424	48,50	24	10,5	3,50	1



Pote cilíndrico

Pot-cilindrique · Milchtopf
Cylindrical pot · Caneca cilíndrica

Ref	€	Ø (cm)	h (cm)	L	U.Venta
85712	29,50	12	12,0	1,00	1
85714	31,60	14	12,5	1,50	1
85716	33,50	16	13,0	2,50	1
85718	37,20	18	14,0	3,50	1



Lote 5 cazos

Ensemble 5 casseroles · Set 5 Tlg. Stielkasserollen
Set 5 saucepans · Lote de 5 caçarola

Ref	€	U.Venta
85003	154,10	1



Cazo recto

Casserole · Stielkasserole, flach
Saucepan · Caçarola direita

Ref	€	Ø (cm)	h (cm)	L	U.Venta
85212	26,10	12	7,0	0,80	1
85214	27,30	14	7,5	1,00	1
85216	30,00	16	8,0	1,50	1
85218	33,30	18	8,5	2,00	1
85220	37,50	20	8,5	2,50	1



Sautex

Sauteuse · Sauteuse
Sauteuse · Frigideira

Ref	€	Ø (cm)	h (cm)	L	U.Venta
85624	40,40	24	7,0	3,50	1



Sartén

Poêle · Pflanne
Frying pan · Sertãs

Ref	€	Ø (cm)	h (cm)	L	U.Venta
85625	38,20	24	7,0	3,50	1
85629	41,50	28	8,0	4,50	1

Pomo abatible · Folding knob



Tapa

Couvercle · Deckel
Lid · Tampa

Ref	€	Ø (cm)	U.Venta
85916	9,20	16	1
85918	9,90	18	1
85920	10,90	20	1
85922	11,10	22	1
85924	12,30	24	1
85926	12,80	26	1
85928	16,50	28	1

GARINOX

Colección



ES

- Cuerpo fabricado en acero inoxidable 18/10.
- Asas, mangos y pomo en baquelita termoaislante.
- Acabado pulido brillante.
- Fondo Termodifusor (inox 18/10 - aluminio - inox).
- Apta para todo tipo de cocinas (incluido inducción).
- Apta para el lavavajillas.

FR

- Corps fabriqué en acier inoxydable 18/10.
- Poignées, manches et pommeau en bakélite thermo-isolante.
- Finition polie brillante.
- Fond thermo-diffuseur (inox 18/10 - aluminium - inox).
- Compatible avec tout type de cuisinières (y compris induction).
- Apte pour le lave-vaisselle.

EN

- Body made in 18/10 stainless steel.
- Handles, grips and knob in heat resistant bakelite.
- Glossy polished finish.
- Heat diffuser bottom (18/10 stainless steel - aluminium - stainless Steel).
- Suitable for all types of cooking surfaces (including induction).
- Dishwasher safe.



Cacerola con tapa

Faitout a/couvercle · Bratentopf mit Deckel
Casserole with lid · Caçarola com tampa

Ref	€	Ø (cm)	h (cm)	L	U.Venta
14318	28,60	18	9,0	2,00	1
14320	33,00	20	10,0	3,00	1
14322	39,00	22	11,0	4,00	1
14324	45,00	24	12,0	5,00	1



Olla con tapa

Marmite avec couvercle · Fleischtopf mit Deckel
Stock pot with Lid · Panela com tampa

Ref	€	Ø (cm)	h (cm)	L	U.Venta
14420	35,40	20	12,0	3,80	1
14422	41,50	22	13,0	5,00	1
14424	49,70	24	15,0	7,00	1



Cazo recto

Casserole · Stielkasserole, flach
Saucepan · Caçarola direita

Ref	€	Ø (cm)	h (cm)	L	U.Venta
14212	10,20	12	5,5	0,60	1
14214	12,70	14	6,5	1,00	1
14216	15,80	16	7,5	1,50	1
14218	19,10	18	9,0	2,00	1
14220	22,50	20	10,0	3,00	1

ES

CAZO

- Fabricados en acero inoxidable de gran calidad.
- Mango de baquelita termoaislante.
- Acabado pulido brillante.

CAZO VERTEADOR

- Fabricados en acero inoxidable de gran calidad.
- Con pico vertedor.
- Mango de baquelita termoaislante.
- Acabado pulido brillante.
- Ideal para calentar leche, hacer chocolate y salsas.

FR

CAZO

- Fabriqué en acier inoxydable de haute qualité.
- Manche en bakélite thermo-isolante.
- Finition polie brillante.

TIROIR VERSEUR

- Fabriqué en acier inoxydable de haute qualité.
- Avec bec verseur.
- Poignée en bakélite thermo-isolante.
- Finition polie brillante.
- Idéal pour chauffer le lait, préparer du chocolat et des sauces.

EN

CAZO

- Made of high quality stainless steel.
- Heat-insulating bakelite handle.
- Bright polished finish.

POURING DRAWER

- Made of high quality stainless steel.
- With pouring spout.
- Heat-insulating bakelite handle.
- Shiny polished finish.
- Ideal for heating milk, making chocolate and sauces.

New

Inox



Cazo recto

Casserole · Stielkasserole, flach
Saucepan · Caçarola direita

Ref	€	Ø (cm)	h (cm)	L	U.Venta
31212	9,10	12	6,5	0,50	1
31214	10,40	14	7,0	1,00	1
31216	11,60	16	7,5	1,50	1
31218	13,20	18	8,0	2,00	1
31220	14,20	20	8,0	2,50	1

Inox



Cazo vertedor

Casserole · Stielkasserole
Saucepan · Caçarola direita de verter

Ref	€	Ø (cm)	h (cm)	L	U.Venta
31312	9,40	12	6,5	0,50	1
31314	10,70	14	7,0	1,00	1
31316	11,90	16	7,5	1,50	1
31318	13,50	18	8,0	2,00	1
31320	14,10	20	8,0	2,50	1

Ideal para calentar leche, chocolate y salsas.

Ideal for heating milk, making chocolate and sauces.



FORTE

Colección



ES

- Fabricada en aluminio fundido y construida en una sola pieza.
- Máxima robustez y gran resistencia a la deformación.
- Revestimiento antiadherente interior y exterior, libre de PFOA.

FR

- Fabriquée en fonte d'aluminium et construite en une seule pièce.
- Robustesse maximale et grande résistance à la déformation.
- Revêtement antiadhésif intérieur et extérieur sans PFOA.
- Inclut un couvercle en verre trempé avec soupape résistante aux chocs.

EN

- Made in Cast Aluminium and in a single piece.
- Maximum robustness and great resistance to deformation.
- Interior non-stick coating and exterior, PFOA free.
- It includes a tempered glass cover with pressure valve resistant to bumps.



Cacerola con tapa cristal

Faitout avec couvercle verre · Bratentopf mit Glasdeckel
Round casserole with glass lid · Caçarola com tampa de vidro

Ref	€	Ø (cm)	h (cm)	L	U.Venta
25816	31,60	16	8,5	1,50	1
25820	34,20	20	8,5	2,50	1
25824	42,70	24	10,5	4,50	1
25828	52,30	28	12,5	7,00	1
25831	62,10	30	13,5	8,70	1



Cacerola baja con tapa cristal

Faitout bas avec couvercle verre · Bratentopf mit Glasdeckel
Round low casserole with glass lid · Caçarola baixa com tampa de vidro

Ref	€	Ø (cm)	h (cm)	L	U.Venta
25823	42,90	24	7,5	2,60	1
25827	52,60	28	7,5	3,60	1
25832	68,10	32	7,5	5,20	1
25835	78,80	36	8,5	7,50	1



Cacerola cuadrada con tapa cristal

Faitout carré avec couvercle verre · Bratentopf mit Glasdeckel
Square casserole with glass lid · Caçarola quadrada com tampa de vidro

Ref	€	cm	h (cm)	L	U.Venta
25829	61,80	28x28	12,0	7,50	1

STILO

Colección



Cacerola con tapa cristal

Faitout avec couvercle verre · Bratentopf mit Glasdeckel
Casserole with glass lid · Caçarola com tampa de vidro

Ref	€	Ø (cm)	h (cm)	L	U.Venta
27320	52,10	20	10,5	2,50	1
27324	60,40	24	12,0	4,00	1
27328	71,20	28	12,5	6,00	1



Tartera con tapa cristal

Faitout bas avec couvercle verre · Bratentopf mit Glasdeckel
Low casserole with glass lid · Caçarola baixa com tampa de vidro

Ref	€	Ø (cm)	h (cm)	L	U.Venta
27327	67,50	28	8,5	4,00	1



Sartén

Poêle · Pfanne
Frying pan · Sertã

Ref	€	ØD (cm)	Ød (cm)	h (cm)	U.Venta
27620	34,60	20	16,5	4,5	6
27624	39,50	24	20,0	5,2	6
27626	43,60	26	21,5	5,5	6
27628	47,10	28	24,0	6,0	6



Cazo recto

Casserole · Stielkasserole, flach
Saucepan · Caçarola direite

Ref	€	Ø (cm)	h (cm)	L	U.Venta
27416	33,20	16	7,5	1,20	1
27418	35,40	18	8,8	1,80	1

Aro protector de silicona
Silicone protective ring



Tapa cristal

Couvercle verre · Glasdeckel
Glass lid · Tampa de vidro

Ref	€	Ø (cm)	U.Venta
27920	9,00	20	1
27924	10,30	24	1
27928	12,70	28	1

Válvula salida de vapor
Steam outlet valve



Grill

Grill · Grill Induktionfähig
Grill · Grelhador

Ref	€	cm	Ød (cm)	h (cm)	U.Venta
27625	43,60	24x24	18,6	4,8	1
27629	50,50	28x28	21,5	5,2	1

TITANIUM PRO

Colección



ES

- Cacerola robusta y duradera gracias a su cuerpo fabricado en aluminio fundido.
- Fabricada en una sola pieza.
- Libre de materiales pesados y tóxicos. ECO y libre de PFOA.
- Compatible con todas las fuentes de calor, incluida la inducción.
- Fácil limpieza interior y exterior.

FR

- Casserole robuste et durable grâce à son corps fabriqué en fonte d'aluminium.
- Fabriquée en une seule pièce.
- Sans matériaux lourds et toxiques. ECO et sans PFOA.
- Compatible avec toutes les sources de chaleur, y compris l'induction.
- Nettoyage intérieur et extérieur facile.

EN

- Robust and durable casserole thanks to its cast aluminium body.
- One piece construction.
- Free of heavy and toxic materials. ECO and PFOA-free.
- Compatible with all heat sources, including induction.
- Easy to clean interior and exterior



- Tapa de vidrio templado reforzada con un aro protector de silicona antipactos y una válvula de salida de vapor.
- Couvercle en verre trempé renforcé avec un pourtour de protection en silicone anti-impacts et une valve de sortie de vapeur.
- Tempered glass lid reinforced with an anti-shock silicone protective ring and a steam outlet valve.

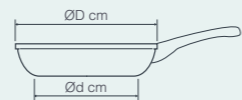

ANTIADHERENTE

PPG Quantanium®
Titanium-reinforced non-stick coating

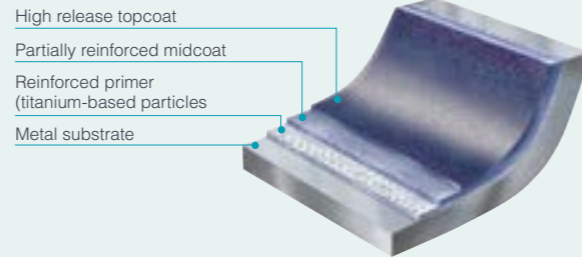

- Antiadherente Quantanium® reforzado con partículas de titanio; libre de materiales tóxicos y pesados, ecológico y libre de PFOA.
- Antiadhésif Quantanium® renforcé avec des particules de titane ; sans matériaux toxiques ni métaux lourds, écologique et sans PFOA.
- Quantanium® non-stick reinforced with titanium particles; free from toxic and heavy materials, environmentally friendly and PFOA-free.

- Asas EXTRAÍBLES fabricadas en silicona de máxima calidad, termoaislantes, altamente resistentes y ergonómicas, permiten un agarre seguro. Mango con acabado SOFT TOUCH, termoaislante, altamente resistente y ergonómico, permite un agarre seguro.

- Poignées AMOVIBLES fabriquées en silicone de la plus grande qualité, thermo-isolantes, hautement résistantes et ergonomiques, qui permettent de tenir l'ustensile en toute sécurité. Manche avec finition SOFT TOUCH, thermo-isolant, hautement résistant et ergonomique, permet une prise en main sûre.
- Heat insulating, highly resistant, ergonomic REMOVABLE handles made of high quality silicone which provide a secure grip on pots and pans. Handle with SOFT TOUCH finish, heat insulating, highly resistant and ergonomic, allows a secure grip.

- FULL INDUCTION; asegura un rendimiento óptimo en todo tipo de cocinas, con un reparto de calor inmejorable logrando la máxima eficiencia y ahorro de energía.

- FULL INDUCTION ; garantit un rendement optimal sur tout type de cuisinière, avec une répartition de la chaleur unique, obtenant ainsi une efficacité et une économie d'énergie maximales.

- FULL INDUCTION diffuser base ensures optimum performance with all kinds of cookers. Its unbeatable heat distribution achieves the best efficiency and energy savings.

Incluye asas de silicona
Includes silicone handles



Cacerola con tapa

Faitout avec couvercle · Bratentopf mit Deckel
Casserole with lid · Caçarola com tampa

Ref	€	Ø (cm)	h (cm)	L	U.Venta
27520	50,60	20	9,5	2,60	1
27524	61,20	24	11,0	4,40	1
27528	74,50	28	12,0	6,60	1

Incluye asas de silicona
Includes silicone handles



Tartera con tapa

Plat rond avec couvercle · Pfanne mit Deckel
Round dish with lid · Tarteira com tampa

Ref	€	Ø (cm)	h (cm)	L	U.Venta
27728	69,70	28	7,5	4,10	1
27732	83,60	32	8,0	5,70	1
27736	98,50	36	8,0	7,30	1



Grill

Grill · Grill Induktionfähig
Grill · Grelhador

Ref	€	cm	Ød (cm)	h (cm)	U.Venta
27827	53,40	28x28	21,0	4,0	1

Válvula salida de vapor
Steam outlet valve



Aro protector de silicona
Silicone protective ring

Tapa de cristal

Couvercle en verre · Glasdeckel
Glass lid · Tampa de vidro

Ref	€	Ø (cm)	U.Venta
27420	10,40	20	1
27424	12,10	24	1
27428	14,00	28	1
27432	15,90	32	1
27436	17,70	36	1



Cazo recto

Casserole · Stielkasserolle, flach
Saucepan · Caçarola direita

Ref	€	Ø (cm)	h (cm)	L	U.Venta
27516	29,30	16	8,0	1,35	1



Sartén

Poêle · Pfanne
Frying-pan · Sertã

Ref	€	ØD (cm)	Ød (cm)	h (cm)	U.Venta
27820	30,70	20	16,6	5,0	6
27824	37,80	24	20,2	5,5	4
27828	45,90	28	23,4	6,0	6



Sartén 4 cavidades

Poêle 4 cavités · Pfanne, 4-fache Einteilung
Frying-pan 4 cavities · Sertã 4 cavidades

Ref	€	cm	Ød (cm)	h (cm)	U.Venta
27832	46,20	32x26	21,0	3,5	1

Si
Silicone



Asas para batería TITANIUM

Poignées · Griffchutz, Silikon
Handles · Asas

Ref	€	Ø (cm)	U.Venta
R27520A	4,30	20	1
R27528A	4,40	24-28	1
R27732A	5,50	32-36	1

FIT Colección



ES

- Tratamiento electrolítico, el aluminio se sella completamente y se endurece para que no pase a los alimentos.
- Gran durabilidad y ultrarresistente: superficie robusta altamente resistente a roces, deformación y corrosión.
- Difunde el calor de forma uniforme evitando el sobrecalentamiento y obteniendo excelentes resultados de cocción.
- Mangos / Asas de acero inoxidable con remaches de aluminio que impiden la transferencia de calor.
- Tapas de vidrio templado reforzadas en el borde con acero inoxidable.
- Compatible con todas las fuentes de calor, incluida la inducción.

FR

- Traitement électrolytique, l'aluminium est totalement scellé et durcit pour ne pas pouvoir atteindre les aliments.
- Grande durabilité et ultra résistante : Surface robuste hautement résistante aux rayures, à la déformation et à la corrosion.
- Diffuse la chaleur de façon uniforme, évitant ainsi la surchauffe et obtenant d'excellents résultats de cuisson.
- Anses et poignées en acier inoxydable avec des rivets en aluminium qui empêchent le transfert de chaleur.
- Couverts en verre trempé renforcés avec le bord en acier inoxydable.
- Compatible avec toutes les sources de chaleur, y compris l'induction.

EN

- Electrolytic treatment, the aluminium is completely sealed and hardened so no metal is passed on to the food.
- Extremely durable and ultra-high strength: It has a robust surface that is highly resistant to abrasion, warping and corrosion.
- It distributes heat evenly to avoid overheating and provide excellent cooking results.
- Stainless steel handles with aluminium rivets that avoid heat transfer.
- The lid is tempered glass with stainless steel reinforcement around the edge.
- Compatible with all heat sources, including induction.

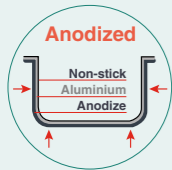

- Capa de óxido natural de protección muy gruesa.
- Couche d'oxydation naturelle de protection très épaisse.
- Thick natural oxide protective layer.



- Muy resistentes a arañazos, deformaciones y corrosión.
- Très résistante aux rayures, à la déformation et à la corrosion.
- Very resistant to scratches, deformation and corrosion.

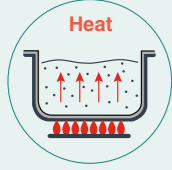

- Distribuye uniformemente el calor, sin áreas de sobrecalentamientos.
- Distribue uniformément la chaleur, sans zones de surchauffe.
- Hot spot free, uniform heat distribution.

ANTIADHERENTE

PPG QuanTanium™
Titanium-reinforced non-stick coating

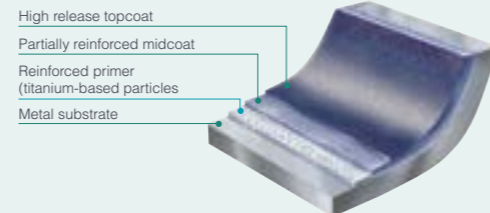

- Antiadherente QuanTanium® reforzado con partículas de titanio; libre de materiales tóxicos y pesados, ecológico y libre de PFOA.
- Antiadhésif QuanTanium® renforcé avec des particules de titane ; sans matériaux toxiques ni métaux lourds, écologique et sans PFOA.
- QuanTanium® non-stick reinforced with titanium particles; free from toxic and heavy materials, environmentally friendly and PFOA-free.



Cacerola con tapa

Faitout avec couvercle · Bratentopf mit Deckel
Casserole with lid · Caçarola com tampa

Ref	€	Ø (cm)	h (cm)	L	e (mm)	U.Venta
48016	42,60	16	8,0	1,50	4,5	1
48020	51,70	20	9,0	2,60	4,5	1
48024	63,50	24	10,0	4,20	4,5	1
48028	74,60	28	11,0	6,30	4,5	1



Olla con tapa

Marmite avec couvercle · Fleichtopf mit Deckel
Stock pot with lid · Panela com tampa

Ref	€	Ø (cm)	h (cm)	L	e (mm)	U.Venta
48116	49,10	16	13,0	2,50	4,5	1
48120	58,10	20	14,0	4,20	4,5	1
48124	73,00	24	15,0	6,50	4,5	1
48128	87,20	28	17,0	10,00	4,5	1



Cazo recto

Casserole · Stielkasserolle, flach
Saucepan · Caçarola direite

Ref	€	Ø (cm)	h (cm)	L	e (mm)	U.Venta
48214	29,60	14	7,5	1,00	4,5	1
48216	33,00	16	8,0	1,50	4,5	1
48218	37,10	18	9,0	2,10	4,5	1
48220	42,00	20	10,0	2,90	4,5	1



Tartera con tapa

Plat rond avec couvercle · Pflanne mit Deckel
Round dish with lid · Tarteira com tampa

Ref	€	Ø (cm)	h (cm)	L	e (mm)	U.Venta
48624	57,30	24	7,0	2,90	4,5	1
48628	68,50	28	8,0	4,50	4,5	1

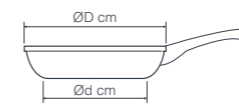

Sartén

Poêle · Pflanne
Frying pan · Sertã

Ref	€	ØD (cm)	Ød (cm)	h (cm)	L	e (mm)	U.Venta
48720	32,30	20	15,0	4,0	0,90	4,5	6
48724	40,40	24	18,0	4,5	1,50	4,5	6
48728	48,20	28	22,0	5,0	2,70	4,5	6

Vidrio templado
Tempered glass



Aro protector de acero inoxidable
Stainless steel protective ring

Válvula salida de vapor
Steam outlet valve

Tapa

Couvercle · Deckel
Lid · Tampa

Ref	€	Ø (cm)	U.Venta
48916	12,00	16	1
48920	13,50	20	1
48924	14,90	24	1
48928	16,60	28	1

EASY Colección



ES

- Fabricadas en aluminio forjado de máxima calidad.
- Excelente conductividad térmica.
- Recubrimiento antiadherente TRlcapa, reforzado a base de partículas de piedra.
- Libres de materiales tóxicos y pesados, ecológico y 100% libre de PFOA.
- Fondo FULL INDUCTION compatible con todas las fuentes de calor, incluida la inducción.
- Asas / Mango de fundición de acero inoxidable.
- Tapa de vidrio templado reforzada en el borde con acero inoxidable.

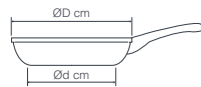

Cacerola con tapa

Faitout avec couvercle · Bratentopf mit Deckel
Casserole with lid · Caçarola com tampa

Ref	€	Ø (cm)	h (cm)	L	e (mm)	U.Venta
27040	47,30	20	8,5	2,00	3,00	1
27044	59,10	24	10,5	3,50	3,00	1
27048	71,20	28	12,5	6,00	3,00	1

FR

- Fabriquée en aluminium forgé de la plus grande qualité.
- Excellente conductivité thermique.
- Revêtement antiadhésif TRlcapa, renforcé à base de particules de pierre.
- Sans matériaux toxiques ni métaux lourds, écologique et 100% sans PFOA.
- Fond FULL INDUCTION compatible avec toutes les sources de chaleur, y compris l'induction.
- Poignées / Manche en fonte d'acier inoxydable.
- Couvercle en verre trempé renforcé sur le bord avec de l'acier inoxydable.



Cacerola baja con tapa

Faitout bas avec couvercle · Bratentopf mit Deckel
Round low casserole with lid · Caçarola baixa com tampa

Ref	€	Ø (cm)	h (cm)	L	e (mm)	U.Venta
27034	50,10	24	6,5	2,00	3,00	1
27038	58,80	28	7,0	3,00	3,00	1

EN

- Made of top quality forged aluminium.
- Excellent thermal conductivity.
- TRlcapa non-stick coating, reinforced with stone particles.
- Free of toxic, heavy materials, environmentally friendly and 100% PFOA-free.
- With FULL INDUCTION base and compatible with all heat sources, including induction.
- Cast stainless steel grips / handle.
- Tempered glass lid with reinforced stainless steel edge.



Cazo recto

Casserole · Stielkasserolle, flach
Saucepan · Caçarola direite

Ref	€	Ø (cm)	h (cm)	L	e (mm)	U.Venta
27056	33,50	16	7,5	1,00	3,00	1
27058	36,60	18	8,0	1,50	3,00	1
27060	40,50	20	8,5	2,00	3,00	1

Mango de fundición de acero inoxidable
Cast stainless steel handle



Sartén

Poêle · Pfanne
Frying-pan · Sertã

Ref	€	ØD (cm)	h (cm)	e (mm)	U.Venta	U.Venta
27018	20,50	18	4,0	3,0	6	6
27020	21,30	20	4,0	3,0	6	6
27022	23,10	22	4,5	3,0	6	6
27024	25,00	24	4,5	3,0	6	6
27026	27,20	26	5,0	3,0	6	6
27028	29,80	28	5,5	3,0	6	6
27030	32,60	30	5,5	3,0	6	6
27032	34,50	32	6,0	3,0	6	6

Vidrio templado
Tempered glass

Aro protector de acero inoxidable
Stainless steel protective ring



Válvula salida de vapor
Steam outlet valve

Tapa

Couvercle · Deckel
Lid · Tampa

Ref	€	Ø (cm)	U.Venta
27070	11,30	20	1
27074	13,10	24	1
27078	14,20	28	1

New



Sartén honda

Poêle profonde · Tiefe Pfanne
Deep frying-pan · Sertã funda

Ref	€	ØD (cm)	Ød (cm)	h (cm)	e (mm)	U.Venta
27134	30,40	24	x	6,5	3,0	1
27138	36,30	28	x	7,0	3,0	1

New



Wok

Wok · Wok
Wok · Wok

Ref	€	Ø (cm)	Ød (cm)	h (cm)	e (mm)	U.Venta
27148	34,10	28	xx	8,0	3,0	1

New



Grill

Grill · Grill Inductionfähing
Grill · Grelhador

Ref	€	cm	Ød (cm)	h (cm)	e (mm)	U.Venta
27158	37,50	28x28	xx	4,0	3,0	1

New



Crepera

Crêpiere · Crêpes Pfanne
Crepiere · Crepeira

Ref	€	ØD (cm)	Ød (cm)	h (cm)	e (mm)	U.Venta
27144	26,90	24	17,0	1,7	3,0	1

COCOTTES

Colección



HINWEIS: In Deutschland nicht verfügbar

ES

- Fabricadas en aluminio fundido.
- Diseño atractivo y funcional.
- Garantizan la absorción y distribución uniforme del calor, sin puntos de sobrecalentamiento.
- La distribución del calor uniforme por toda la pieza hace que los alimentos no pierdan su jugo durante la cocción, conservando así todos sus nutrientes y vitaminas.
- Las puntas situadas bajo la tapa, hacen que las gotas fruto de la condensación, vuelvan a caer sobre los alimentos formando un flujo circulante y permanente reduciendo la pérdida de sabores y jugos de los alimentos.
- Es la pieza perfecta para: arroces, carnes, pescados, legumbres, verduras, guisos, cremas, salsas, sopas, etc.
- Revestimiento antiadherente ILAG:ULTIMATE.

FR

- Fabriquée en fonte d'aluminium.
- Style attractif et grande fonctionnalité.
- Garantit l'absorption et la distribution uniforme de la chaleur, sans points de surchauffe.
- La distribution de la chaleur uniforme sur toute la pièce permet aux aliments de ne pas perdre leur jus pendant la cuisson, conservant ainsi tous leurs nutriments et vitamines.
- Les pointes situées sous le couvercle permettent aux gouttes issues de la condensation de retomber sur les aliments, formant ainsi un flux permanent de circulation qui réduit la perte des saveurs et des jus des aliments.
- C'est la pièce parfaite pour : riz, viandes, poissons, légumes, ragoûts, crèmes, sauces, soupes, etc.
- Revêtement antiadhésif ILAG: ULTIMATE.

EN

- Made in cast aluminium.
- Attractive design and great functionality.
- It guarantees the absorption and uniform distribution of heat, without overheating points.
- The uniform distribution of heat throughout the product makes keep its juices during cooking, preserving all its nutrients and vitamins.
- The points located under the lid cause the condensation drops to fall back onto the food, forming a permanent and circulating flow and reducing the loss of the food's flavours and juices.
- This is an ideal product for: rice, meats, fish, beans, vegetables, stews, creams, sauces, soups, etc.
- Non-stick coating ILAG: ULTIMATE.



Cacerola con tapa MINI

Faitout avec couvercle "MINI" · "MINI" Bratentopf mit Deckel
"MINI" round casserole with lid · Caçarola com tampa "MINI"

	Ref	€	Ø (cm)	h (cm)	L	U.Venta
A	25909	22,50	10	5,0	0,24	12
	25914	33,00	14	7,5	0,90	1
B	25910	22,50	10	5,0	0,24	1
	25915	33,00	14	7,5	0,90	1



Cacerola oval con tapa MINI

Faitout Ovale avec couvercle "MINI" · "MINI" Oval Bratentopf mit Deckel
"MINI" oval round casserole with lid · Caçarola oval com tampa "MINI"

	Ref	€	cm	h (cm)	L	U.Venta
A	25911	23,70	12x8,5	5,0	0,25	1
B	25912	22,40	12x8,5	5,0	0,25	1



Cacerola con tapa

Faitout avec couvercle · Bratentopf mit Deckel
Round casserole with lid · Caçarola com tampa

	Ref	€	Ø (cm)	h (cm)	L	U.Venta
	25916	48,60	16	7,0	1,30	1
	25920	63,30	20	8,0	2,40	1
A	25924	81,70	24	10,0	4,20	1
	25928	104,20	28	11,5	6,70	1
B	25917	54,00	16	7,0	1,30	1
	25921	71,20	20	8,0	2,40	1
	25925	89,10	24	10,0	4,20	1
	25929	109,00	28	11,5	6,70	1



Cacerola oval con tapa

Faitout Ovale avec couvercle · Oval Bratentopf mit Deckel
Oval round casserole with lid · Caçarola oval com tampa

	Ref	€	cm	h (cm)	L	U.Venta
	25927	75,30	26x20	9,0	3,50	1
A	25931	103,40	31x25	11,0	6,30	1
B	25933	81,30	26x20	9,0	3,50	1
	25935	112,00	31x25	11,0	6,30	1



Cazo recto

Casserole · Stielkasserole, flach
Saucepan · Caçarola direite

Ref	€	ØD (cm)	Ød (cm)	h (cm)	e (mm)	L	U.Venta
25956	29,70	16	12,0	8,0	1,6	1,30	1
25958	33,30	18	15,0	8,5	1,6	1,80	1
25950	36,50	20	16,5	9,0	1,6	2,40	1



Protección total
Full protection

Manoplas de silicona GRIS

Mouffettes en silicone · Griffchutz aus Silikon
Silicone mittens · Pegas de silicone

Ref	€	Ø (cm)	U.Venta
R25917G	8,20	16	6
R25921G	7,80	20-24-28	6
R25933G	8,20	26x20	6
R25935G	7,80	31x25	6



Incluye asas de silicona
Includes silicone handles

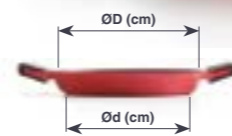

Paellera

Plat rond · Pfanne
Round · Paelheira

Ref	€	ØD (cm)	Ød (cm)	h (cm)	e (mm)	Raciones	U.Venta
25932	82,10	32	25,5	4,5	1,6	5	1
25936	95,90	36	29,5	4,5	2,0	7	1
25940	106,60	40	33,5	4,5	2,0	9	1

- Fabricadas en aluminio fundido. Revestimiento antiadherente Xylan Plus.
- Garantizan la absorción y distribución uniforme del calor, sin puntos de sobrecalentamiento.
- La distribución del calor uniforme por toda la pieza hace que los alimentos no pierdan su jugo durante la cocción, conservando así todos sus nutrientes y vitaminas.
- Fondo difusor FULL INDUCTION; asegura un rendimiento óptimo en todo tipo de cocinas, con un reparto de calor inmejorable logrando la máxima eficiencia y ahorro de energía.
- Perfectas para arroces, carnes, pescados, legumbres, verduras, guisos, cremas, salsas, sopas, etc.
- Diseño atractivo y funcional.
- Compatibles con todo tipo de cocinas, incluida la inducción.

- Made in cast aluminium. Non-stick coating Xylan Plus.
- It guarantees the absorption and uniform distribution of heat, without overheating points.
- The uniform distribution of heat throughout the product makes keep its juices during cooking, preserving all its nutrients and vitamins.
- The FULL INDUCTION diffuser bottom ensures optimal performance on all kinds of cookers with unbeatable heat distribution that achieves maximum efficiency and energy savings.
- Ideal product for: rice, meats, fish, beans, vegetables, stews, creams, sauces, soups, etc.
- Attractive design and great functionality.
- It's compatible with all kinds of cookers, including induction.

MINI Colección



ES

- Fabricadas en aluminio fundido de máxima calidad.
- Ideal tanto para cocinar como para presentar aperitivos o platos.
- Antiadherente bicapa de alta calidad y 100% libre de PFOA.
- Libres de materiales tóxicos, pesados, disolventes y sustancias químicas.
- Diseñadas para una cocina saludable: permite cocinar sin apenas aceite garantizando que los alimentos no se peguen.
- Distribución homogénea del calor que permite una cocción rápida y uniforme.
- Aptas para todo tipo de fuegos: gas, eléctrica, vitrocerámica e inducción.
- Tapa fabricada en vidrio templado con válvula de salida de vapor.
- Pomo baquelita con acabado Soft Touch.
- Mango ergonómico con acabado Soft Touch.

FR

- Fabriqué en fonte d'aluminium de la plus grande qualité.
- Idéale aussi bien pour cuisiner que pour la d'apéritifs ou de plats.
- Finition antiadhésive bi-couche de grande qualité et 100% sans PFOA.
- Sans matériaux toxiques, métaux lourds, dissolvants et substances chimiques.
- Conçue pour une cuisine saine : permet de cuisiner sans à peine utiliser d'huile et avec la garantie que les aliments ne collent pas.
- Distribution homogène de la chaleur, ce qui permet une cuisson rapide et uniforme.
- Apte pour tous types de feux : gaz, électricité, vitrocéramique, four et induction.
- Couvercle fabriqué en verre trempé avec valve à vapeur.
- Poignée en bakélite avec finition Soft Touch.
- Manche ergonomique avec finition Soft Touch.

EN

- Made from a single piece of top quality cast aluminium.
- It's perfect for both cooking and presenting appetisers or dishes.
- It has a high quality bi-layer non-stick coating that is 100% PFOA free.
- It's free of toxic materials, heavy metals, solvents and chemical substances.
- It's designed for healthy cooking. It lets you cook with practically no oil and be sure that food won't stick.
- Food is cooked quickly and evenly because of the homogeneous heat distribution.
- It's suitable for all kinds of cookers: gas, electric, vitroceramic, oven and induction.
- The lid is made of tempered glass with a steam valve.
- Bakelite handle with a Soft Touch finish.
- Ergonomic handle with a Soft Touch finish.



Cacerola con tapa

Faitout avec couvercle · Bratentopf mit Deckel
Casserole with lid · Caçarola com tampa

Ref	€	Ø (cm)	ØBase (cm)	h (mm)	e (mm)	L	U.Venta
25160	20,90	16	12,0	5,0	1,6	0,8	1



Cazo recto

Casserole · Stielkasserole, flach
Saucepan · Caçarola direite

Ref	€	Ø (cm)	ØBase (cm)	h (mm)	e (mm)	L	U.Venta
25164	16,20	14	10,0	8,0	1,6	1,0	1



Paellera

Plat à paella · Pfanne
Round dish · Paelheira

Ref	€	Ø (cm)	ØBase (cm)	h (mm)	e (mm)	L	U.Venta
25161	20,90	20	11,5	4,5	1,8	1,0	1



Sartén

Poêle · Pfanne
Frying pan · Sertã

Ref	€	Ø (cm)	ØBase (cm)	h (mm)	e (mm)	U.Venta
25163	12,80	14	10,0	3,0	1,6	1



Grill

Grill · Grill Induktionfähig
Grill · Grelhador

Ref	€	cm	ØBase (cm)	h (mm)	e (mm)	U.Venta
25162	14,10	14x14	10,0	2,5	1,6	1

SMALT Colección



ES

- Cacerola y paellera de hierro muy resistentes.
- Cubiertas con una capa de esmalte vitricado antiácido de máxima calidad.
- Asas altamente reforzadas.
- Perfectas para presentar y servir sabrosas tapas, raciones o pinchos.

FR

- Faitout et poêle à paella en fer très résistantes.
- Possèdent un revêtement avec une couche d'acier émaillé de la plus grande qualité.
- Anses hautement renforcées.
- Parfaites pour présenter et servir de savoureuses tapas, de petites portions ou des amuse-bouches.

EN

- Extremely strong metal casserole and paella dish.
- Coated with a layer of top quality antacid vitrified enamel.
- Heavily reinforced handles.
- Perfect for serving or presenting delicious tapas, dishes or pinchos.



Cacerola esmaltada

Faitout à paella · Bratentopf, emailiert
Casserole · Caçarola esmaltada

Ref	€	Ø (cm)	h (cm)	U.Venta
60192	6,50	12	4,0	1
60196	7,70	16	4,5	1
60190	8,50	20	4,7	1



Paellera esmaltada

Plat à paella · Paellapfanne, emailiert
Round dish for paella · Paelheira esmaltada

Ref	€	Ø (cm)	U.Venta
60170	5,10	10	10
60172	5,70	12	10
60175	6,70	15	6
60180	8,60	20	6



ES

- Construida en una sola pieza.
- Recubierta con una capa de aceite vegetal.
- Ideal para cocinar, prolonga suavemente la cocción.
- Gran conductor del calor, mantiene el calor mientras disfrutas y saboreas la comida.
- Base de madera para servir y presentar la comida recién cocinada.

FR

- Construite en une seule pièce.
- Revêtu d'une couche d'huile végétale.
- Idéal pour cuisiner, prolonge délicatement la cuisson.
- Grand conducteur de chaleur, maintient le plat au chaud pendant que vous dégustez la nourriture.
- Base en bois pour servir et présenter le plat fraîchement cuisiné.

EN

- Built in one piece.
- Coated with a layer of vegetable oil.
- Ideal for cooking; gently continues to cook.
- Great heat conductor; retains heat while you enjoy and savour the food.
- Wooden base to serve and present freshly cooked food.



Cacerola

Faitout · Bratentopf
Casserola · Caçarola

Ref	€	Ø (cm)	ml	U.Venta
25771	10,70	12,5	230	4
25772	15,60	16,2	470	4
25773	18,80	18,5	720	1



Cacerola con base

Faitout avec basse · Bratentopf mit Holzsockel
Casserola with base · Caçarola com base

Ref	€	Ø (cm)	ml	U.Venta
25871	15,40	12,5	230	4
25872	21,00	16,2	470	1
25873	27,00	18,5	720	1



Cacerola oval

Faitout ovale · Oval Bratentopf
Oval casserola · Caçarola oval

Ref	€	cm	ml	U.Venta
25781	12,10	15x10	200	4
25782	19,00	17,5x12,5	300	1
25783	21,60	21,7x15	700	1



Cacerola oval con base

Faitout ovale avec basse · Oval Bratentopf mit Holzsockel
Oval casserola with base · Caçarola oval com base

Ref	€	cm	ml	U.Venta
25881	15,60	15x10	200	4
25882	24,00	17,5x12,5	300	1
25883	26,70	21,7x15	700	1



Mini plancha grill lisa rectangular

Mini plaque grill lisse rectangulaire · Mini Platte Grill, glatt, rechteckiger
Mini rectangular grill plaque flat · Mini plancha grill liso rectangular

Ref	€	cm	h (cm)	U.Venta
25774	10,20	17x10	2,5	4



Mini plancha grill lisa rectangular con base

Mini plaque Grill lisse rectang. a/basse · Mini Platte Grill, glatt, rechteckiger m/Holzsockel
Mini rectangular grill plaque flat with base · Mini plancha grill liso rectangular c/base

Ref	€	cm	h (cm)	U.Venta
25874	15,00	17x10	2,5	4



Mini plancha grill cuadrado

Mini plaque grill carré · Mini Platte Grill, Quadrat
Mini square grill plaque · Mini plancha grill cuadrado

Ref	€	cm	h (cm)	U.Venta
25775	10,70	14x14	1,7	4



Mini plancha grill cuadrado con base

Mini plaque grill carré avec basse · Mini Platte Grill, Quadrat mit Holzsockel
Mini square grill plaque with base · Mini plancha grill cuadrado com base

Ref	€	cm	h (cm)	U.Venta
25875	15,00	14x14	1,7	4



Mini grill

Mini grill · Mini Grill
Mini grill · Mini grill

Ref	€	cm	h (cm)	U.Venta
25776	11,10	14x14	2,5	4



Mini grill con base

Mini grill avec basse · Mini Grill mit Holzsockel
Mini grill with base · Mini grill com base

Ref	€	cm	h (cm)	U.Venta
25876	17,30	14x14	2,5	1



Mini sartén lisa

Mini poêle lisse · Mini Pflanne
Mini frying pan flat · Mini sertã lisa

Ref	€	Ø (cm)	h (cm)	U.Venta
25777	11,20	13	1,7	4



Mini sartén lisa c/base

Mini poêle lisse avec basse · Mini Pflanne mit Holzsockel
Mini frying pan flat with base · Mini sertã lisa com base

Ref	€	Ø (cm)	h (cm)	U.Venta
25877	16,10	13	1,7	1

MAGMA GREY & RED

Colección



ES

- Acabado exterior e interior esmaltado, muy resistente y de gran durabilidad.
- Muy versátil: ideal para cocinar asados, arroces, pasta, cocer a fuego lento e incluso hornear tartas dulces y pan.
- Conserva todos los nutrientes, vitaminas y sabores de los alimentos.
- Excelente retención y distribución uniforme del calor.
- Incluye base de madera, ideal para servir y presentar.
- Apta para todo tipo de fuegos.

FR

- Finition extérieure et intérieure émaillée. Émail très résistant et d'une grande durabilité.
- Très versatile : idéale pour cuisiner des ragoûts, du riz, des pâtes, cuire à feu doux et même enfourner des gâteaux et du pain.
- Conserve tous les nutriments, les vitamines et les saveurs des aliments.
- Excellente rétention et distribution uniforme de la chaleur.
- Inclut une base en bois, idéale pour servir et présenter.
- Apte pour tous types de feux.

EN

- Enamel finish inside and outside. Very strong and durable enamel.
- Extremely versatile: perfect for roasts, rice, pasta, low heat cooking and even baking bread or cake.
- Preserves all the nutrients, vitamins and flavours of the food.
- Excellent heat retention and uniform heat distribution.
- Wooden base included, perfect for serving or presentation.
- Appropriate for all kinds of cookers.



Cacerola redonda

Faitout rond · Rund Bratentopf
Round casserole · Caçarola redonda

	Ref	€	Ø (cm)	h (cm)	ml	U.Venta
	25841	17,60	12,0	3,0	200	1
A	25848	27,30	16,2	3,0	470	1
	25849	33,90	18,5	3,0	720	1
	25851	17,60	12,0	3,0	200	1
B	25858	27,30	16,2	3,0	470	1
	25859	33,90	18,5	3,0	720	1

Cacerola oval

Faitout ovale · Oval Bratentopf
Oval casserole · Caçarola oval

	Ref	€	cm	h (cm)	ml	U.Venta
	25842	23,50	17,5x12,5	3,0	250	1
A	25840	33,80	21,7x15	3,0	700	1
	25852	23,70	17,5x12,5	3,0	250	1
B	25850	34,10	21,7x15	3,0	700	1



Sartén

Poêle · Pflanne
Frying pan · Sertā

	Ref	€	Ø (cm)	h (cm)	ml	U.Venta
A	25843	17,70	13,5	3,0	275	1
B	25853	17,70	13,5	3,0	275	1

Cacerola redonda con tapa

Faitout rond avec couvercle · Rund Bratentopf mit Deckel
Round casserole with lid · Caçarola redonda com tampa

	Ref	€	Ø (cm)	h (cm)	ml	U.Venta
A	25846	28,50	10	5,0	200	1
B	25856	28,50	10	5,0	200	1



Cacerola rectangular con tapa

Faitout rectangulaire avec couvercle · Bratentopf, rechteckig mit Deckel
Rectangular casserole with lid · Caçarola rectangular com tampa

	Ref	€	cm	h (cm)	ml	U.Venta
A	25845	33,40	13x9	4,5	300	1
B	25855	33,40	13x9	4,5	300	1

Cacerola oval con tapa

Faitout ovale avec couvercle · Oval Bratentopf mit Deckel
Oval casserole with lid · Caçarola oval com tampa

	Ref	€	cm	h (cm)	ml	U.Venta
A	25847	33,80	13x10	5,0	400	1
B	25857	33,80	13x10	5,0	400	1



CHEF-LUXE

Olla a presión



Sistema de apertura y cierre con una sola mano
Opening and closing system with one hand

ES

- Sistema de apertura y cierre con una sola mano.
- Selección de posiciones (3 posiciones: 0 - I - II).
- Se puede utilizar como una cacerola normal.

FR

- Ouverture et de fermeture d'une seule main.
- Sélection positions(3 positions: 0 - I - II).
- Peut être utilisé comme une casserole normale.

EN

- Opening and closing system with one hand.
- Selecting positions (3 position: 0 - I - II).
- Can be used as a normal casserole.



Olla a presión

Cocotte à pression · Schnellkochtopf
Pressure cooker · Panela de pressão

Ref	€	Ø (cm)	h (cm)	L	U.Venta
50815	590,80	32	18,0	15,0	1
50818	608,00	32	23,0	20,0	1
50823	638,70	32	32,0	23,0	1



Cuerpo olla a presión

Corps cocotte à pression · Schnellkochtopf-Körper
Pressure cooker stockpot · Corpo panela de pressão

Ref	€	Ø (cm)	h (cm)	L	U.Venta
50816	203,90	32	18,0	15,0	1
50819	221,10	32	23,0	20,0	1
50824	251,80	32	32,0	23,0	1



Tapa

Couvercle · Deckel
Lid · Tampa

Ref	€	Ø (cm)	U.Venta
A 50934	386,90	32	1
B 54932	27,80	32	1

Ollas a presión
Pressure Cookers

ROBUST

Olla a presión



ES

- Diseñada para uso profesional.
- Fabricada en aluminio de máxima calidad (grado de pureza 99,55%).
- Especialmente indicada para cocinas de gas, eléctricas y vitrocerámicas.
- Excelente conductor térmico. Rápida y eficiente. Posee un elevado rendimiento energético (70%).
- Triple sistema de seguridad.
- Puente más robusto y resistente.
- Asas de baquelita antiquemaduras.

FR

- Conçue pour un usage professionnel.
- Il est conçu en aluminium haute qualité (degré de pureté de 99,5 %).
- Adaptée aux gaz, cuisinières électriques et plaques de cuisson.
- Excellent conducteur thermique. Rapide et efficace. Confère un rendement énergétique élevé (70%).
- Triple système de sécurité.
- Pont plus robuste et résistant.
- Poignées en bakélite anti-brûlures.

EN

- For Professional use.
- Made of high quality aluminium (with a 99.5% degree of purity).
- Suitable for gas, electric, cookers and cooktops.
- Excellent thermal conductivity. Fast and efficient. High energy performance (70%).
- Triple safety system.
- Stronger and more robust bridge.
- Anti-scald bakelite handles.



Triple sistema de seguridad
Triple safety system

1
2
3



Asas de baquelita antiquemaduras

Anti-scald bakelite handles



Olla a presión

Cocotte à pression · Schnellkochtopf
Pressure cooker · Panela de pressão

Ref	€	Ø (cm)	h (cm)	L	U.Venta
20830	1.357,80	42	31	30	1
20840	1.447,90	42	39	40	1
20850	1.538,30	42	46	50	1

PRO-CLASSIC

Olla a presión



ES

- Diseñada para uso profesional.
- Fabricada en aluminio.
- Especialmente indicada para cocinas de gas, eléctricas y vitrocerámicas.
- Excelente conductor térmico. Rápida y eficiente. Posee un elevado rendimiento energético (70%).
- Válvula de presión/contrapeso: permite que se libere el vapor regulando la presión interior de la olla.
- Válvula de seguridad/despresurización: actúa en caso en el que falle la válvula de presión.
- Puente más robusto y resistente.
- Asas de baquelita antiquemaduras.

FR

- Conçue pour un usage professionnel.
- Fabriquée en aluminium.
- Adaptée aux gaz, cuisinières électriques et plaques de cuisson.
- Excellent conducteur thermique. Rapide et efficace. Confère un rendement énergétique élevé (70%).
- Soupape à pression/contreponds : permet de libérer la vapeur en régulant la pression intérieure de l'autocuiseur.
- Soupape de sécurité/dépressurisation : agit dans le cas d'un dysfonctionnement de la soupape à pression.
- Pont plus robuste et résistant.
- Poignées en bakélite anti-brûlures.

EN

- For Professional use.
- Made of aluminium.
- Suitable for gas, electric, cookers and cooktops.
- Excellent thermal conductivity. Fast and efficient. High energy performance (70%).
- The pressure/counterweight valve lets steam escape and regulates pressure inside the pot.
- Safety/depressurisation valve: acts in case of failure of the pressure valve.
- Stronger and more robust bridge.
- Anti-scald bakelite handles.



	Válvula de seguridad Safety valve	Válvula de cocción Cooking valve
A	1	1
B	1	2
C	2	2



Olla a presión

Cocotte à pression · Schnellkochtopf
Pressure cooker · Panela de pressão

	Ref	€	Ø (cm)	h (cm)	L	U.Venta
	20511	111,50	28	19,0	11,0	1
	20515	128,20	30	25,0	15,0	1
A	20518	159,50	32	23,0	18,0	1
	20522	177,30	34	23,0	22,0	1
	20533	211,90	36	32,0	33,0	1
B	20540	229,80	40	32,5	40,0	1
C	20550	274,50	44	34,0	50,0	1

New
New

CLASSIC

Olla a presión



ES

- Fabricada en acero inoxidable 18/10 de máxima calidad.
- Marcaje interior, grabado con la capacidad del uso de la olla.
- Asas de baquelita antiquemaduras. Válvula de seguridad.
- Apta para todo tipo de cocinas. Triple fondo FULL INDUCTION para una distribución rápida y homogénea del calor.
- * Las referencias 71872-71875 contienen un cestillo.

FR

- Fabrication en acier inoxydable 18/10 de qualité maximale.
- Marquage intérieur, marquage gravé de la capacité d'utilisation de l'autocuiseur.
- Poignées en bakélite anti-brûlures. Soupape de sécurité.
- Apte pour tout type de feux. Triple fond FULL INDUCTION pour une distribution rapide et homogène de la chaleur.
- * Les références 71872-71875 contiennent un panier.

EN

- Manufactured in high-quality 18/10 stainless steel.
- Inner marking, engraved with the cooker's capacity.
- Burn-resistant Bakelite handles Safety valve.
- Suitable for any type of hob. Tri-ply FULL INDUCTION base for quick, even heat distribution.
- * The 71872-71875 references contain a basket.



Marcajes de capacidad en litros

Capacity markings inside in litres



Asas de baquelita antiquemaduras

Anti-scald bakelite handles



Olla a presión

Cocotte à pression · Schnellkochtopf
Pressure cooker · Panela de pressão

Ref	€	Ø (cm)	h (cm)	L	U.Venta
71874	86,60	22	11,5	4,0	1
71876	95,00	22	17,0	6,0	1
71878	103,90	24	19,0	8,0	1
71871	113,20	24	23,0	10,0	1
71872	178,60	26	23,0	12,0	1 *
71875	192,30	26	29,0	15,0	1 *

GENIUS

Olla a presión



ES

- Fabricada: acero inoxidable 18/10 de máxima calidad. Acabado pulido espejo exterior.
- Marcaje interior: Grabado con la capacidad del uso de la olla.
- Cierre fácil y seguro: Gracias a su asa ergonómica, es fácil y cómodo de abrir.
- Triple fondo difusor: Garantiza una óptima difusión del calor, favoreciendo un importante ahorro de energía (70%) y una cocción uniforme resaltando el aroma y sabor de los alimentos.
- Sistema de seguridad: Válvula de seguridad, actúa en caso de aumento excesivo de presión, despresurizando rápidamente la olla.
- Apta para todo tipo de cocinas y el lavavajillas.

FR

- Fabrication : En acier inoxydable 18/10 de qualité maximale. Finition polissage miroir extérieur.
- Marquage intérieur : Marquage gravé de la capacité d'utilisation de l'autocuiseur.
- Fermeture facile et sûre : Grâce à son manche ergonomique, permet une ouverture simple et pratique.
- Triple fonds diffuseur : Garantit une diffusion optimale de la chaleur, favorisant ainsi d'importantes économies d'énergie (70%) et une cuisson uniforme accentuant l'odeur et le goût des aliments.
- Système de sécurité : Soupape de sécurité, agit en cas d'augmentation excessive de la pression, dépressurisant rapidement
- Apte pour tout type de cuisinières et le lave-vaisselle.

EN

- Manufactured: High-quality 18/10 stainless steel. Exterior mirror-polished finish.
- Inner marking: Engraved with the cooker's capacity.
- Easy, safe closing: Thanks to its ergonomic handle, it's easy and convenient to open.
- Triple diffuser base: Ensures optimum heat diffusion, enabling a significant energy saving (70%) and even cooking that enhances the aroma and flavour of the food.
- Safety system: The safety valve operates in the case of an excessive increase in pressure, quickly releasing pressure from the cooker.
- Suitable for all types of cookers and dishwashers.

Olla a presión

Cocotte à pression · Schnellkochtopf
Pressure cooker · Panela de pressão

Ref	€	Ø (cm)	h (cm)	L	U.Venta
71904	59,60	22	11,5	4,0	1
71906	65,70	22	17,0	6,0	1
71908	74,10	24	19,0	8,0	1
71901	82,10	24	23,0	10,0	1



SICURO

Olla a presión



Sistema de apertura y cierre con una sola mano
One-handed opening and closing mechanism

Nivel de cocción: 0 y 100kpa
Cooking level

Fondo termodifusor
Thermo-diffuser bottom



ES

- Fabricada en acero inoxidable 18/10 de máxima calidad con acabado satinado.
- Fondo termodifusor sandwich; distribución rápida y uniforme del calor.
- Marcaje interior en litros.
- Asas termorresistentes que aseguran un manejo cómodo y seguro.
- Ahorra un 70% de energía conservando el aroma y sabor de los alimentos.
- Nivel de cocción totalmente ajustable: gira el pomo y elige la presión entre 0 y 100kpa.
- Cierre fácil y 100% seguro: sistema de apertura y cierre con una sola mano.
- Triple sistema de seguridad:
 - * Válvula de seguridad, actúa en caso de aumento excesivo de presión, despresurizando rápidamente la olla.
 - * Sistema de bloqueo de seguridad, imposibilidad de apertura de la tapa mientras cocinamos.
 - * Ventana lateral de seguridad.
- Compatible con todas las fuentes de calor, incluida la inducción. Cuerpo apto para el lavavajillas.

FR

- Fabriqué en acier inoxydable 18/10 de la plus grande qualité avec finition satinée.
- Fond thermo-diffuseur sandwich : distribution rapide et uniforme de la chaleur.
- Marquage intérieur en litres.
- Poignées thermorésistantes qui garantissent une prise en main pratique et sûre.
- Économise 70% d'énergie en conservant l'arôme et le goût des aliments.
- Niveau de cuisson entièrement réglable : tourner le pommeau et choisir la pression de 0 à 100 kPa.
- Fermeture facile et 100% sûre : système d'ouverture et fermeture avec une seule main.
- Triple système de sécurité :
 - * Soupape de sécurité qui agit en cas d'augmentation excessive de la pression en dépressurant rapidement l'autocuiseur.
 - * Système de blocage de sécurité, impossibilité d'ouvrir le couvercle pendant la cuisson.
 - * Fenêtre latérale de sécurité.
- Compatible avec toutes les sources de chaleur, y compris l'induction. Corps apte pour le lave-vaisselle.

EN

- Made of top quality 18/10 stainless steel with satin finish.
- Sandwich thermo-diffuser bottom for fast, even heat distribution.
- Graduated litre marks inside.
- Heat-resistant handles for comfortable, safe grip.
- Saves 70% energy whilst still retaining the aroma and flavour of the food.
- Fully adjustable cooking level: turn the knob to select the pressure setting from 0 to 100 kPa.
- Simple, 100% safe one-handed opening and closing mechanism.
- Triple safety system:
 - * Safety valve, which opens in the event of excessive pressure and quickly depressurises the cooker.
 - * Safety locking system, preventing the lid from being opened while cooking is in progress.
 - * Safety pressure relief opening on the side.
- Compatible with all heat sources, including induction. Dishwasher safe body.



Olla a presión

Cocotte à pression · Schnellkochtopf
Pressure cooker · Panela de pressão

Ref	€	Ø (cm)	h (cm)	L	U.Venta
71784	199,20	22	11,0	4,0	1
71786	205,10	22	16,0	6,0	1
71788	215,60	22	21,1	8,0	1

MASTER

Olla a presión



Niveles de cocción
Cooking levels

Marcaje interior
Inner marking

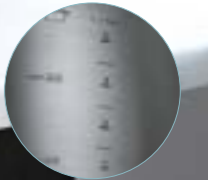

ES

- Fabricada en acero inoxidable 18/10 de máxima calidad.
- Marcaje interior, grabado con la capacidad del uso de la olla.
- Visualizador de los niveles de cocción mediante anillos de colores.
- 2 niveles de cocción:
 - * Rápida (verduras, hortalizas y pescados).
 - * Superrápida (carnes y estofados).
- Válv. de seguridad · Sist. de bloqueo de seguridad · Ventanas laterales de seguridad.
- Apta para todo tipo de cocinas.
- Fondo FULL INDUCTION.

FR

- Fabrication en acier inoxydable 18/10 de qualité maximale.
- Marquage intérieur, marquage gravé de la capacité d'utilisation de l'autocuiseur.
- Visualisateur des niveaux de cuisson via anneaux de couleur.
- 2 niveaux de cuisson :
 - * Rapide (légumes et les poissons).
 - * Super rapide (viandes et les ragoûts).
- Soupape de sécurité · Syst. de blocage de sécurité · Fenêtres latérales de sécurité.
- Apte pour tout type de feux.
- Fond FULL INDUCTION.

EN

- Manufactured in high-quality 18/10 stainless steel.
- Inner marking, engraved with the cooker's capacity.
- Cooking level indicator-display using coloured rings.
- 2 cooking levels:
 - * Fast (vegetables and fish).
 - * Super-fast (meats and stews).
- Safety valve · Safety locking system · Side safety windows.
- Suitable for any type of hob.
- FULL INDUCTION base.



Olla a presión

Cocotte à pression · Schnellkochtopf
Pressure cooker · Panela de pressão

Ref	€	Ø (cm)	h (cm)	L	U.Venta
71884	79,30	22	15,5	4,0	1
71886	86,10	22	22,0	6,0	1
71887	103,80	24	23,5	8,0	1



TEMPO

Olla a presión



ES

- Fabricada en acero inoxidable 18/10 de máxima calidad.
- Marcaje interior, grabado con la capacidad del uso de la olla.
- Válvula de control para seleccionar el nivel de presión.
- Niveles de cocción: cocción lenta y cocción rápida.
- Válvula de seguridad · Sistema de bloqueo de seguridad · Ventanas laterales de seguridad.
- Apta para todo tipo de cocinas.
- Triple fondo FULL INDUCTION para una distribución rápida y homogénea del calor.

FR

- Fabrication en acier inoxydable 18/10 de qualité maximale.
- Marquage intérieur, marquage gravé de la capacité d'utilisation de l'autocuiseur.
- Valve de contrôle pour sélectionner le niveau de pression
- Niveaux de cuisson : cuisson lente et cuisson rapide.
- Soupape de sécurité · Syst. de blocage de sécurité · Fenêtres latérales de sécurité.
- Apte pour tout type de feux.
- INDUCTION TOTALE triple fond pour une distribution rapide et homogène de la chaleur

EN

- Manufactured in high-quality 18/10 stainless steel.
- Inner marking, engraved with the cooker's capacity.
- Control valve for selecting the power level.
- Cooking levels: slow cooking and fast cooking.
- Safety valve · Safety locking system · Side safety windows.
- Suitable for any type of hob.
- Tri-ply FULL INDUCTION base for quick, even heat distribution.



Niveles de cocción
Cooking levels

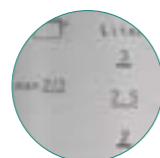

Marcaje interior
Inner marking



Olla a presión

Cocotte à pression · Schnellkochtopf
Pressure cooker · Panela de pressão

Ref	€	Ø (cm)	h (cm)	L	U.Venta
71864	87,20	22	15,0	4,0	1
71866	89,70	22	23,0	6,0	1
71868	96,30	22	27,0	8,0	1

Set de ollas a presión

Ensemble de cocottes à pression · Schnellkochtopf-Satz
Set of pressure cooker · Conj. de panelas de pressão

Ref	€	Ø (cm)	h (cm)	L	U.Venta
71862	136,80	22	16,0	6,0	1
		22	22,0	4,0	

Sartenes
Fryingpan

CHEF-INOX

Sartenes



ES

- Fabricadas en acero inoxidable 18/10 de la mejor calidad.
- Máxima garantía en resistencia, durabilidad e higiene.
- Acabado interior y exterior lijado satinado.
- Fondo termodifusor sandwich, distribución rápida y uniforme del calor.
- Homogeneidad y eficacia térmica.
- Cocción ultrarrápida.
- Aptas para todos los fuegos.

FR

- Fabriquées en acier inoxydable 18/10 de la meilleure qualité.
- Garantie maximale de résistance, de durabilité et d'hygiène.
- Finition interne et externe en brossage satiné.
- Fond thermo-diffuseur sandwich, distribution rapide et uniforme de la chaleur.
- Homogénéité et efficacité thermique.
- Cuisson ultra-rapide.
- Aptes pour tous les feux.

EN

- Made of 18/10 stainless steel of the best quality.
- Maximum guarantee in resistance, durability and hygiene.
- Glossy sanded interior and exterior finish.
- Heat-diffusing sandwiched base, quick and even heat distribution.
- Thermal homogeneity and efficiency.
- Ultra-rapid cooking.
- Suitable for all types of cookers.



Sartén CHEF-CLASSIC

Poêle · Pflanne
Frying-pan · Sertã

Ref	€	Ø (cm)	h (cm)	e (mm)	U.Venta
51620	40,90	20	4,0	1,0	1
51624	45,20	24	4,5	1,0	1
51628	54,70	28	5,5	1,0	1
51632	65,50	32	6,0	1,0	1
51636	82,20	36	6,5	1,0	1
51640	98,30	40	6,5	1,0	1

- Sartén sin antiadherentes, fabricada en acero inoxidable, sartén ecológica.
- Ideal para cocinar como un profesional.
- Puedes utilizarlas en el horno.

- Poêle à frire antiadhésive, en acier inoxydable, poêle à frire écologique.
- Idéale pour cuisiner comme un professionnel.
- Peut être utilisée au four.

- Non-stick frying pan, made of stainless steel, ecological frying pan.
- Ideal for cooking like a professional.
- Can be used in the oven.



Sartén CHEF-CLASSIC PLUS

Poêle · Pflanne
Frying-pan · Sertã

Ref	€	Ø (cm)	h (cm)	e (mm)	U.Venta
51621	50,20	20	4,0	1,0	1
51625	56,30	24	4,5	1,0	1
51629	67,80	28	5,5	1,0	1
51633	84,20	32	6,0	1,0	1
51637	109,10	36	6,5	1,0	1
51641	127,20	40	6,5	1,0	1



Sartén CHEF-CLASSIC CERAM

Poêle · Pflanne
Frying-pan · Sertã

Ref	€	Ø (cm)	h (cm)	e (mm)	U.Venta
51720	51,90	20	4,0	1,0	1
51724	58,90	24	4,5	1,0	1
51728	71,10	28	5,5	1,0	1
51732	88,80	32	6,0	1,0	1
51736	110,00	36	6,5	1,0	1
51740	128,90	40	6,5	1,0	1

Homogeneidad y eficacia térmica.
Cocción ultrarrápida.

Thermal homogeneity and efficiency.
Ultra-rapid cooking.



FERRUM

Colección



ES

- Disfruta de una sartén para toda la vida.
- Fabricadas artesanalmente con 100% hierro natural.
- Calidad Premium; duraderas y resistentes a arañazos.
- Alta conductividad térmica. El hierro al ser un excelente conductor del calor, permite conseguir y mantener la temperatura ideal de cocción con un menor consumo energético.
- Espesor 2,5 mm. Fácil limpieza.
- Cocina ecológica, cocina saludable.
- Antiadherente premium, libre de PFOA (sartén antiadherente).

FR

- Une poêle qui vous durera toute la vie.
- Fabriquées de façon artisanale avec 100% de métal naturel.
- Qualité Premium; durables et résistantes aux rayures.
- Haute conductivité thermique. Le métal, excellent conducteur de chaleur, permet d'obtenir et de maintenir la température de cuisson idéale avec une consommation d'énergie moins importante.
- Épaisseur 2,5mm. Nettoyage facile.
- Cuisine écologique, cuisine saine.
- Antiadhésif premium, sans PFOA (Poêle antiadherent).

EN

- Enjoy this one pan your whole life.
- Hand-made in 100% natural iron.
- Premium Quality; long lasting and resistant to scratching.
- High heat conduction. Iron is an excellent conductor of heat, allowing you to obtain and maintain the ideal temperature with less energy consumption.
- 2.5mm thickness. Easy to clean. Eco-friendly, healthy kitchen.
- Premium Quality; long lasting and resistant to scratching (Non-stick frying-pan).



Sartén
Poêle · Pflanne
Frying-pan · Sertä

Ref	€	Ø (cm)	h (cm)	e (mm)	U.Venta
* 63620	30,00	20	3,5	2,5	1
* 63624	34,60	24	4,5	2,5	1
* 63626	37,30	26	4,5	2,5	1
* 63628	39,30	28	5,0	2,5	1
* 63632	47,10	32	5,3	2,5	1
63636	60,00	36	5,5	2,5	1
63640	66,50	40	5,8	2,5	1

* Compatible con nuestro mango de silicona (Ref.: 23900)
Compatible with our silicone handle (Ref.: 23900)



Sartén antiadherente
Poêle antiadherent · Pflanne, Antihafht
Frying-pan, non-stick · Sertä anti-aderente

Ref	€	Ø (cm)	h (cm)	e (mm)	U.Venta
* 63720	33,90	20	3,5	2,5	1
* 63724	37,30	24	4,5	2,5	1
* 63726	39,90	26	4,5	2,5	1
* 63728	42,20	28	5,0	2,5	1
* 63732	49,60	32	5,3	2,5	1
63736	62,70	36	5,5	2,5	1
63740	72,50	40	5,8	2,5	1

* Compatible con nuestro mango de silicona (Ref.: 23900)
Compatible with our silicone handle (Ref.: 23900)



Sartén honda

Poêle profonde · Tiefe Pflanne
Deep frying-pan · Sertä funda

Ref	€	Ø (cm)	h (cm)	e (mm)	U.Venta
* 63424	50,20	24	7,0	2,5	1
* 63428	58,10	28	8,0	2,5	1
* 63432	85,80	32	8,8	2,5	1

Con asa
With handle

* Compatible con nuestro mango de silicona (Ref.: 23900)
Compatible with our silicone handle (Ref.: 23900)



Sartén Blinis

Poêle Blinis · Blinis Pflanne
Blinis frying pan · Sertä Blinis

Ref	€	Ø (cm)	h (cm)	e (mm)	U.Venta
63613	25,00	12	2,1	2,0	6
63614	28,00	14	2,2	2,0	6



Cazo bombado

Casserole bombée · Kasserolle, Bauchig
Rounded saucepan · Caçarola bojuda

Ref	€	Ø (cm)	h (cm)	e (mm)	U.Venta
* 63419	46,20	20	10	2,5	1
* 63423	58,10	24	12	2,5	1

* Compatible con nuestro mango de silicona (Ref.: 23900)
Compatible with our silicone handle (Ref.: 23900)



Sartén Blinis antiadherente

Poêle Blinis antiadherent · Blinis Pflanne, Antihafht
Blinis frying pan, Non-stick · Sertä Blinis anti-aderente

Ref	€	Ø (cm)	h (cm)	e (mm)	U.Venta
63712	26,40	12	2,1	2,0	6
63714	29,10	14	2,2	2,0	6



Asador antiadherente

Rôtissoire, antiadherent · Grill, Antihafht
Non-stick rotisserie · Grelhador anti-aderente

Ref	€	Ø (cm)	h (cm)	e (mm)	U.Venta
* 63727	38,40	26	3,0	2,5	1

* Compatible con nuestro mango de silicona (Ref.: 23900)
Compatible with our silicone handle (Ref.: 23900)

Asas de acero inoxidable
Stainless steel handles



Paellera

Plat à paella · Paellapflanne
Round dish for paella · Paelheira

Ref	€	Ø (cm)	h (cm)	e (mm)	Raciones	U.Venta
63928	57,10	28	4,5	2,5	3	1
63932	64,70	32	4,7	2,5	5	1
63936	80,70	36	5,5	2,5	7	1
63940	88,90	40	5,5	2,5	9	1

Asas de acero inoxidable
Stainless steel handles



Plancha Grill lisa

Plaque à Grill lisse · Platte Grill, glatt
Grill flat plaque · Plancha Grill lisa

Ref	€	cm	h (cm)	e (mm)	U.Venta
63642	69,20	37 x 27	5,0	2,5	1

Asas de acero inoxidable
Stainless steel handles



Plancha Grill

Plaque à Grill · Platte Grill
Grill plaque · Plancha Grill

Ref	€	cm	h (cm)	e (mm)	U.Venta
63644	73,50	37 x 27	5,0	2,5	1



Protector de silicona

Protection en silicone · Silikonschutz
Silicone handle cover · Protector de silicone

Ref	€	L (cm)	U.Venta
23900	6,40	13,5	1

- Mango protector de silicona de alta calidad para sartenes.
- Fácil de colocar, se ajusta perfectamente al mango de la sartén.
- Antideslizante y termorresistente, protege de las temperaturas elevadas.
- Compatible con nuestras sartenes Robust, Ferrum, Dynamic y Tricapa Plus (Ø16-32).

- Manche de protection en silicone de grande qualité pour poêles.
- Facile à installer, il s'adapte parfaitement au manche de la poêle.
- Antidérapant et thermorésistant, il protège des températures élevées.
- Compatible avec nos poêles Ferrum, Robust, Dynamic et Tricapa Plus (Ø16-32).

- High quality protective silicone handle for frying pans.
- Easy to put on, it fits the pan handle perfectly.
- Non-slip and heat-resistant, it protects from high temperatures.
- Compatible with our Ferrum, Robust, Dynamic and Tricapa Plus frying pans (Ø16-32).



Wok

Wok · Wok
Wok · Wok

Ref	€	Ø (cm)	Ød (cm)	h (cm)	e (mm)	U.Venta
* 63828	48,40	28	15	8,0	2,0	1
* 63232	54,70	32	15	9,5	2,0	1

* Compatible con nuestro mango de silicona (Ref.: 23900)
Compatible with our silicone handle (Ref.: 23900)



Wok antiadherente

Wok, Antiadherent · Wok, Antihalt
Wok, non-stick · Wok anti-aderente

Ref	€	Ø (cm)	Ød (cm)	h (cm)	e (mm)	U.Venta
* 63829	50,40	28	15	8,0	2,0	1
* 63233	57,50	32	15	9,5	2,0	1

* Compatible con nuestro mango de silicona (Ref.: 23900)
Compatible with our silicone handle (Ref.: 23900)



Crepera antiadherente

Crêpière, antiadherent · Crêpes-Pfanne, Antihalt
Crepiere, Non-stick · Crepeira anti-aderente

Ref	€	Ø (cm)	h (cm)	e (mm)	U.Venta
* 23323	27,20	22	1,8	2,5	1
* 23327	31,10	26	2,2	2,5	1

* Compatible con nuestro mango de silicona (Ref.: 23900)
Compatible with our silicone handle (Ref.: 23900)

- Se adapta a todo tipo de baterías de cocina.
- Vidrio térmico resistente a altas temperaturas.
- Borde de acero inoxidable 18/10.

- Convient à tous les types d'batteries de cuisine.
- Verre trempé résistant aux températures élevées.
- Jante en acier inoxydable 18/10.

- Fits all types of cookware.
- Tempered glass resistant to high temperatures.
- 18/10 stainless steel rim.



Tapa de cristal con desvaporizador

Couvercle en verre avec sortie de vapeur · Glasdeckel mit Dampfloch
Glass Lid with steam hole · Tapa de vidro con desvaporizador

Ref	€	Ø (cm)	U.Venta
71914	10,70	14	1
71916	11,00	16	1
71918	11,30	18	1
71920	12,20	20	1
71922	12,30	22	1
71924	12,80	24	1
71926	14,10	26	1
71928	14,70	28	1
71932	16,60	32	1

BASIC & RUSTIC

Wok



ES

- Ideal para preparar salteados, quedando crujientes y conservando sus nutrientes.
- Duraderos y resistentes a arañazos.
- Alta conductividad térmica. El hierro al ser un excelente conductor del calor, permite conseguir y mantener la temperatura ideal de cocción con un menor consumo energético.
- Ligero y manejable.
- Mango ergonómico.
- Antiadherente tri-capa, libre de materiales tóxicos y pesados, ecológico y libre de PFOA.
- Fácil limpieza.
- Apta para todo tipo de cocinas, incluida la inducción

FR

- Idéal pour les sautés, les aliments restent croustillant et conservent leurs nutriments.
- Durable et résistant aux rayures.
- Haute conductivité thermique. Le métal, excellent conducteur de chaleur, permet d'obtenir et de maintenir la température de cuisson idéale avec une consommation d'énergie moins importante.
- Léger et maniable.
- Poignée ergonomique.
- Antiadhésif à trois couches, sans matériaux toxiques ni métaux lourds, écologique et sans PFOA.
- Nettoyage facile.
- Compatible avec tout type de cuisinières.

EN

- Ideal for making stir-fries, keeping ingredients crisp and preserving their nutrients.
- Durable and scratch-resistant.
- High thermal conductivity. Being an excellent heat conductor, iron allows the ideal cooking temperature to be quickly reached and maintained using less energy consumption.
- Lightweight and practical.
- Ergonomic handle.
- Three-layer non-stick coating, free from toxic and heavy materials, environmentally friendly and PFOA-free.
- Easy to clean.
- Suitable for all types of cooking surfaces.



Wok antiadherente BASIC

Wok, Antiadherent · Wok, Antihalt
Wok, Non-stick · Wok anti-aderente

Ref	€	Ø (cm)	Ød (cm)	h (cm)	e (mm)	U.Venta
63729	35,80	28	15	8,5	0,9	1
63733	36,40	32	15	9,5	0,9	1

New



Wok antiadherente RUSTIC

Wok, Antiadherent · Wok, Antihalt
Wok, Non-stick · Wok anti-aderente

Ref	€	Ø (cm)	Ød (cm)	h (cm)	e (mm)	U.Venta
66128	35,80	28	15	8,5	0,9	1
66132	36,40	32	15	9,5	0,9	1

ROBUST Colección



ES

- Sartenes fabricadas en aluminio de máxima calidad diseñadas para uso profesional.
- Óptima distribución de calor conservando las propiedades nutritivas de los alimentos y con un mínimo gasto de aceite y energía.
- Recubrimiento antiadherente multicapa (5 capas) ecológico y libre de PFOA.
- Ideales para un uso continuo. Ligeras, manejables y fáciles de limpiar gracias a su antiadherente exterior.
- Aptas para todo tipo de cocinas, excepto inducción.

FR

- Poêles fabriquées en aluminium de grande qualité conçues pour un usage professionnel.
- Distribution optimale de la chaleur en conservant les propriétés nutritives des aliments et avec une utilisation d'huile et d'énergie minimales.
- Revêtement antiadhésif multicouches (5 couches) écologique et sans PFOA.
- Idéales pour un usage continu. Légères, maniables et faciles à nettoyer grâce à leur revêtement antiadhésif extérieur.
- Compatibles avec tout type de cuisinière, excepté l'induction.

EN

- Pans made in top quality aluminium and design for professional use.
- Optimal heat distribution, preserving the nutritional properties and with a minimal waste of oil and energy.
- Multi-layer (5 layers) eco-friendly non-stick coating, PFOA-free.
- Ideal for continuous use. Light, easy handling and easy to clean due to its nonstick exterior.
- Suitable for all types of cooking surfaces, except induction.



Sartén
Poêle · Pfanne
Frying-pan · Sertä

Ref	€	Ø (cm)	h (cm)	e (mm)	U.Venta
23616	14,80	16	3,5	2,5	6
23618	16,00	18	3,5	2,5	6
* 23620	19,00	20	4,0	3,5	6
* 23622	22,30	22	4,0	3,5	6
* 23624	24,40	24	4,5	3,5	6
* 23626	29,50	26	4,5	4,0	6
* 23628	31,60	28	4,5	4,0	6
* 23632	38,10	32	4,7	4,0	6
23636	49,60	36	5,5	4,0	4
23640	58,20	40	5,5	4,0	4

* Compatible con nuestro mango de silicona (Ref.: 23900)
Compatible with our silicone handle (Ref.: 23900)



Sartén ROBUST PLUS
Poêle · Pfanne
Frying-pan · Sertä

Ref	€	Ø (cm)	h (cm)	e (mm)	U.Venta
23816	16,60	16	3,5	2,5	6
23818	17,70	18	3,5	2,5	6
23820	21,40	20	4,0	3,5	6
23822	24,10	22	4,0	3,5	6
23824	26,80	24	4,5	3,5	6
23826	31,00	26	4,5	4,0	6
23828	36,10	28	4,5	4,0	6
23832	41,90	32	4,7	4,0	6
23836	51,40	36	5,5	4,0	4
23840	62,10	40	5,5	4,0	4



Sartén honda
Poêle profonde · Tiefe Pfanne
Deep frying-pan · Sertä funda

Ref	€	ØD (cm)	Ød (cm)	h (cm)	e (mm)	U.Venta
* 23625	41,80	24	18,5	6,5	3,5	1
* 23629	47,50	28	22,0	6,5	4,0	1

* Compatible con nuestro mango de silicona (Ref.: 23900)
Compatible with our silicone handle (Ref.: 23900)



Sartén Blinis
Poêle Blinis · Pfanne Blinis
Frying-pan Blinis · Sertä Blinis

Ref	€	Ø (cm)	h (cm)	e (mm)	U.Venta
23612	11,40	12	2,1	2,5	6
23614	13,40	14	2,2	2,5	6



Sartén oval
Poêle ova · Pfanne, oval
Oval frying-pan · Sertä oval

Ref	€	cm	h (cm)	e (mm)	U.Venta
23637	63,70	36x26	5,0	2,7	1
23641	66,30	40x29	5,5	2,7	1



Sartén rectangular
Poêle rectangulière · Pfanne, rechteckig
Rectangular frying-pan · Sertä rectangular

Ref	€	cm	h (cm)	e (mm)	U.Venta
* 23638	55,70	38x26	5,0	4,0	1

* Compatible con nuestro mango de silicona (Ref.: 23900)
Compatible with our silicone handle (Ref.: 23900)



Wok
Wok · Wok
Wok · Wok

Ref	€	Ø (cm)	h (cm)	e (mm)	U.Venta
23830	43,80	30	7,0	4,0	1

* Compatible con nuestro mango de silicona (Ref.: 23900)
Compatible with our silicone handle (Ref.: 23900)



Crepera
Crêpiere · Crêpes Pfanne
Crepiere · Crepeira

Ref	€	Ø (cm)	h (cm)	e (mm)	U.Venta
* 23322	18,00	22	1,8	2,5	1
* 23326	22,70	26	1,8	2,7	1
* 23330	32,80	30	2,2	4,0	1

* Compatible con nuestro mango de silicona (Ref.: 23900)
Compatible with our silicone handle (Ref.: 23900)



Paellera
Plat rond · Paellapfanne
Round dish · Paelheira

Ref	€	Ø (cm)	h (cm)	U.Venta
23724	22,80	24	4,00	1
23728	29,90	28	4,50	1
23732	35,20	32	5,00	1
23736	42,50	36	5,50	1
23740	52,60	40	6,00	1

ALUMINIO

Sartenes



ES

- Sartenes fabricadas en aluminio de máxima calidad diseñadas para uso profesional.
- Recubrimiento antiadherente.
- Ecológico, libre de materiales tóxicos y pesados. Libre de PFOA.
- Aptas para todo tipo de cocinas, excepto inducción.

FR

- Poêles fabriquées en aluminium de grande qualité conçues pour un usage professionnel.
- Revêtement antiadhésif.
- Écologique, exempt de matériaux toxiques et lourds. Sans PFOA.
- Compatible tous feux sauf induction, excepté induction.

EN

- Pans made in top quality aluminium and design for professional use.
- Ecological, free of toxic and heavy materials. PFOA free.
- Suitable for all types of cooking surfaces, except induction.



Sartén CHEF-TRICAPA
Poêle · Pflanne
Frying pan · Sertã

Ref	€	Ø (cm)	h (cm)	e (mm)	U.Venta
21618	26,30	18	3,8	2,5	6
21620	28,80	20	4,0	3,5	6
21622	31,50	22	4,0	3,5	6
21624	34,80	24	4,5	3,5	6
21626	38,50	26	4,5	4,0	6
21628	43,80	28	4,5	4,0	6
21632	51,70	32	4,7	4,0	6
21636	61,60	36	5,5	4,0	4
21640	71,40	40	5,5	4,0	4



Sartén honda CHEF-TRICAPA
Poêle profonde · Tiefe Pflanne
Deep frying-pan · Sertã funda

Ref	€	ØD (cm)	Ød (cm)	h (cm)	e (mm)	U.Venta
21524	53,20	24	18,5	6,5	3,5	1
21528	65,80	28	22,0	6,5	4,0	1



Sartén DYNAMIC
Poêle · Pflanne
Frying-pan · Sertã

Ref	€	Ø (cm)	h (cm)	e (mm)	U.Venta
23416	14,80	16	3,5	2,5	6
23418	16,00	18	3,5	2,5	6
* 23420	19,00	20	4,0	3,5	6
* 23422	22,30	22	4,0	3,5	6
* 23424	24,70	24	4,5	3,5	6
* 23426	29,50	26	4,5	4,0	6
* 23428	31,90	28	4,5	4,0	6
* 23432	38,50	32	4,7	4,0	6
23436	49,60	36	5,5	4,0	4



Sartén c/fondo ECO-CHEF
Poêle avec fond · Pflanne mit Boden
Frying-pan with botton · Sertã com fundo

Ref	€	Ø (cm)	h (cm)	e (mm)	U.Venta
22718	31,30	18	3,8	2,5	6
22720	35,50	20	4,0	3,5	6
22722	38,80	22	4,0	3,5	6
22724	41,40	24	4,5	3,5	6
22726	48,00	26	4,5	4,0	6
22728	52,30	28	4,5	4,0	6
22732	61,30	32	4,7	4,0	6
22736	72,20	36	5,5	4,0	4

TITANIUM^{PRO}

Colección



Sartén
Poêle · Pflanne
Frying-pan · Sertã

Ref	€	ØD (cm)	Ød (cm)	h (cm)	U.Venta
27820	30,70	20	16,6	5,0	6
27824	37,80	24	20,2	5,5	4
27828	45,90	28	23,4	6,0	6



Sartén 4 cavidades
Poêle 4 cavités · Pflanne, 4-fache Einteilung
Frying-pan 4 cavities · Sertã 4 cavidades

Ref	€	cm	Ød (cm)	h (cm)	U.Venta
27832	46,20	32x26	21,0	3,5	1



Grill
Grill · Grill Induktionfähig
Grill · Grelhador

Ref	€	cm	Ød (cm)	h (cm)	U.Venta
27827	53,40	28x28	21,0	4,0	1

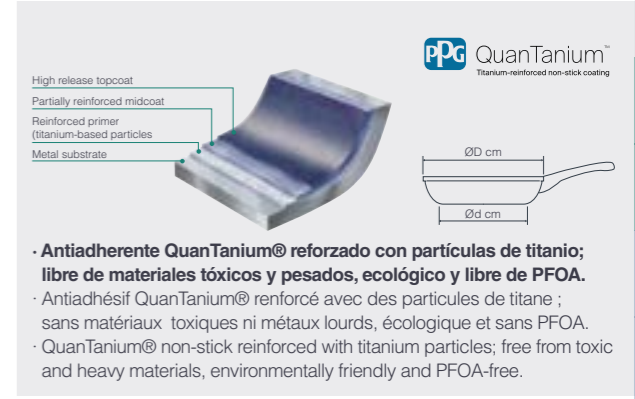

- **Antiadherente QuanTanium® reforzado con partículas de titanio; libre de materiales tóxicos y pesados, ecológico y libre de PFOA.**
- Antiadhésif QuanTanium® renforcé avec des particules de titane ; sans matériaux toxiques ni métaux lourds, écologique et sans PFOA.
- QuanTanium® non-stick reinforced with titanium particles; free from toxic and heavy materials, environmentally friendly and PFOA-free.

STILO

Colección



ES

- Cuerpo fabricado en una sola pieza.
- Fabricada en aluminio fundido de gran robustez.
- Recubrimiento en piedra hiperresistente a los arañazos.
- Revestimiento antiadherente de alta calidad y ecológico, libre de PFOA.
- Apta para todo tipo de cocinas, incluida la inducción.

FR

- Construite en une seule pièce.
- Fabriquée en fonte d'aluminium d'une grande robustesse.
- Revêtement en pierre hyper résistant aux rayures.
- Revêtement antiadhésif de grande qualité et écologique, exempt de PFOA.
- Compatible avec tout type de cuisines, y compris l'induction.

EN

- Body made in one piece.
- Manufactured in highly-robust cast aluminium.
- Super scratch-resistant stone coating.
- High-quality, ecological, PFOA-free anti-stick coating.
- Suitable for all types of kitchens, including those with induction cookers.

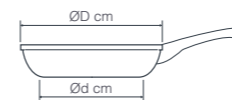

Sartén
Poêle · Pflanne
Frying pan · Sertã

Ref	€	ØD (cm)	Ød (cm)	h (cm)	U.Venta
27620	34,60	20	16,5	4,5	6
27624	39,50	24	20,0	5,2	6
27626	43,60	26	21,5	5,5	6
27628	47,10	28	24,0	6,0	6



Grill
Grill · Grill Induktionfähig
Grill · Grelhador

Ref	€	cm	Ød (cm)	h (cm)	U.Venta
27625	43,60	24x24	18,6	4,8	1
27629	50,50	28x28	21,5	5,2	1

ECO-PIEDRA BLACK

Colección



ES

- Fabricadas en aluminio fundido de gran calidad y espesor, están reforzadas con partículas a base de piedra y una máxima resistencia al rayado, duración y desgaste.
- La base de aluminio permite una distribución homogénea del calor, permitiendo que los alimentos se cocinen rápidamente y de manera uniforme, sin apenas utilizar aceite.
- Su antiadherente TRicapa de máxima calidad y ecológico, es libre de PFOA.
- Fácil limpieza interior y exterior gracias al antiadherente.
- Fondo FULL INDUCTION compatible con todas las fuentes de calor, incluida la inducción. Excelente conductividad térmica.
- Se puede lavar en el lavavajillas.
- Paelleras · Planchas: asas fabricadas en silicona de máxima calidad, termo aislantes, altamente resistentes y ergonómicas, permiten un agarre seguro de la piza.

FR

- Fabriquées en fonte d'aluminium de grande qualité et épaisseur, elles sont renforcées par particules à base de pierre et confère une résistance maximale aux rayures et à l'usure pour allonger la durée de vie.
- La base en aluminium permet une distribution homogène de la chaleur, permettant aux aliments de se cuire rapidement et de façon uniforme, sans à peine utiliser d'huile Leur antiadhésif.
- Tri-couche d'une qualité maximale et écologique, est sans PFOA.
- Intérieur et extérieur faciles à nettoyer grâce à la protection antiadhésive.
- Fond « FULL INDUCTION » compatible avec toutes les sources de chaleur, y compris l'induction. Excellente conductivité thermique.
- Peuvent être lavées au lave-vaisselle.
- Plat à paella · Planches : poignées fabriquées en silicone de la plus grande qualité, thermo-isolantes, hautement résistantes et ergonomiques, qui permettent de tenir l'ustensile en toute sécurité.

EN

- Made in high quality and thickness cast aluminium, it is reinforced with stone-based particles and maximum scratch and wear resistance and durability.
- The aluminium base allows for a homogeneous heat distribution, allowing the food to cook quickly and uniformly, without barely any oil.
- Its high quality and eco-friendly non-stick coating TRicapa is PFOA-free.
- Easy to clean interior and exterior with its non-stick protection.
- FULL INDUCTION base that can be used with all kinds of heat sources, including induction cookers. Excellent thermal conductivity.
- Dishwasher safe.
- Round dish · Grill plaque: heat insulating, highly resistant, ergonomic handles made of high quality silicone which provide a secure grip on pots and pans.



Sartén

Poêle · Pfanne
Frying pan · Sertä

Ref	€	ØD (cm)	Ød (cm)	h (cm)	e (mm)	U.Venta
24118	27,20	18	14,0	5,0	4,0	6
24120	30,90	20	14,5	5,0	4,0	6
24122	32,90	22	15,6	5,5	4,0	6
24124	35,70	24	17,4	6,0	4,0	6
24126	39,80	26	18,4	6,0	4,0	6
24128	42,30	28	20,5	6,0	4,0	6
24130	45,00	30	21,0	6,0	4,0	6



Sartén Blinis

Poêle Blinis · Pfanne Blinis
Frying pan Blinis · Sertä Blinis

Ref	€	ØD (cm)	Ød (cm)	h (cm)	e (mm)	U.Venta
24114	13,00	14	10,0	5,6	4,0	1



Wok

Wok · Wok
Wok · Wok

Ref	€	ØD (cm)	Ød (cm)	h (cm)	e (mm)	U.Venta
24138	43,00	28	16,0	9,0	4,0	1



Crepera

Crêpiere · Crêpes Pfanne
Crepiere · Crepeira

Ref	€	ØD (cm)	Ød (cm)	h (cm)	e (mm)	U.Venta
24137	32,50	24	17,0	1,8	4,0	1
24136	36,10	26	18,0	1,8	4,0	1



Grill

Grill · Grill
Grill · Grelhador

Ref	€	cm	Ød (cm)	h (cm)	e (mm)	U.Venta
24123	37,10	24x24	16,7	4,5	4,0	1
24127	44,60	28x28	19,0	4,5	4,0	1
24125	37,20	24x24	16,7	4,5	4,0	1
24129	44,70	28x28	19,0	4,5	4,0	1



Paellera

Plat à paella · Pfanne
Round dish · Paelheira

Ref	€	ØD (cm)	Ød (cm)	h (cm)	Raciones	e (mm)	U.Venta
25432	74,50	32	25,5	4,5	5	1,6	1
25436	79,70	36	29,5	4,5	7	2,0	1
25440	93,00	40	33,5	4,5	9	2,0	1

Incluye asas de silicona
Includes silicone handles



Fondo NO Full Induction
NOT Full induction bottom

Plancha Grill

Plaque à Grill · Platte Grill
Grill plaque · Plancha Grill

Ref	€	Area cocción (cm)	ØBase (cm)	h (cm)	cm (Total)	e (mm)
25536	37,00	25,5x20	18,0	1,5	37,5x23x4,5	4,0
25547	51,30	33,5x25	21,0	2,0	47,5x29x5,5	4,0



Plancha Grill

Plaque à Grill · Platte Grill
Grill plaque · Plancha Grill

Ref	€	Area cocción (cm)	ØBase (cm)	h (cm)	cm (Total)	e (mm)	U.Venta
24134	65,10	33x25	24,0	2,0	46x27,5x6	4,0	1
24135	67,70	33x25	24,0	2,0	46x27,5x6	4,0	1

Si
Silicone



Asas para paellera ECO-PIEDRA

Poignées pour plat rond · Griffschutz for Pfanne
Handles for round dish · Asas para paelheira

Ref	€	Ø (cm)	U.Venta
R25436A	11,60	32-36-40	1

Si
Silicone



Asas para plancha Grill

Poignées pour plaque à Grill · Griffschutz for Platte Grill
Handles for grill plaque · Asas para plancha Grill

Ref	€	cm	U.Venta
R25736A	4,00	36	1
R25747A	5,60	47	1
R25536A	4,00	36	1
R25547A	5,60	47	1

TitanFull

Plancha grill



ES

- Fabricada en aluminio fundido de gran calidad.
- Diseñada para cocinar todo tipo de verduras, carnes, pescados, etc. de forma saludable y sin apenas utilizar aceite.
- Ahorro energético, hasta un 45% más eficiente, gracias a su fondo FULL INDUCTION.
- Distribución homogénea del calor: permite que los alimentos se cocinen rápidamente y de manera uniforme.
- Diseñada para uso doméstico y rendimiento profesional.
- Máxima resistencia al desgaste.
- Compatible con todo tipo de cocinas, incluida la inducción.

FR

- Fabriquée en fonte d'aluminium de grande qualité
- Conçue pour cuisiner tous types de légumes, viandes, poissons, etc. de façon saine et sans à peine utiliser d'huile.
- Économies d'énergie : jusqu'à 45% plus efficace grâce à son fond FULL INDUCTION rectangulaire.
- Distribution homogène de la chaleur : les aliments cuisent uniformément, sans à peine ajouter d'huile.
- Conçue aussi bien pour une utilisation professionnelle que domestique.
- Résistance maximale contre l'usure.
- Compatible avec tous types de feu, y compris l'induction.

EN

- Kitchen grill made of high quality very thick cast aluminium.
- Designed for cooking all kinds of vegetables, meat, fish, etc. in a healthy way with hardly any oil.
- Environmentally friendly and 100% PFOA free.
- Energy saving, up to 45% more efficient because of its rectangular FULL INDUCTION bottom.
- Even heat distribution: food can be cooked quickly and evenly with hardly any oil.
- Designed for home use and professional performance.
- Maximum wear resistance.
- Compatible with all kinds of cookers, including induction

Incluye asas de silicona
Includes silicone handles



Plancha Grill

Plaque à Grill · Platte Grill
Grill plaque · Plancha Grill

Ref	€	Area cocción (cm)	h (cm)	e (mm)	U.Venta
24347	110,50	34x25	3	5,0	1

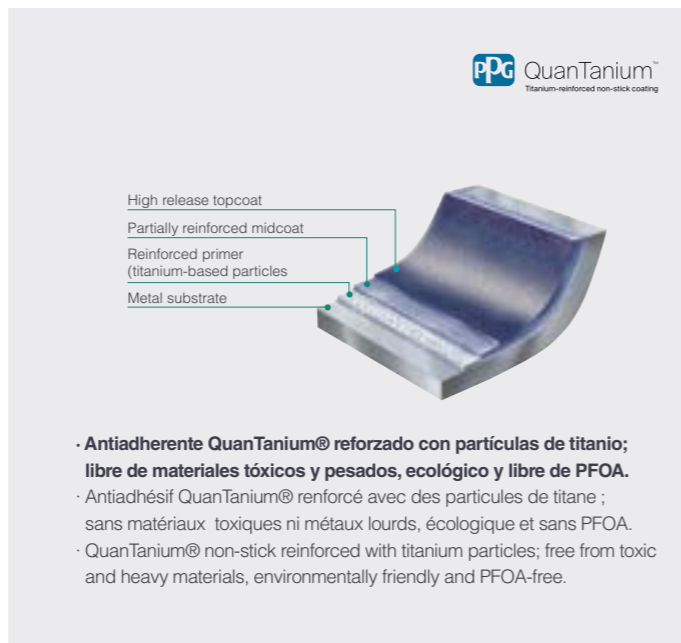

- Antiadherente Quantanium® reforzado con partículas de titanio; libre de materiales tóxicos y pesados, ecológico y libre de PFOA.
- Antiadhésif Quantanium® renforcé avec des particules de titane ; sans matériaux toxiques ni métaux lourds, écologique et sans PFOA.
- Quantanium® non-stick reinforced with titanium particles; free from toxic and heavy materials, environmentally friendly and PFOA-free.

SUA

Sartén grill



ES

- Sartén parrilla grill fabricada en aluminio fundido de máxima calidad.
- Acabado antiadherente bicapa de alta calidad y 100% libre de PFOA. Libre de materiales tóxicos, pesados, disolventes y sustancias químicas.
- Diseñadas para una cocina saludable: permite cocinar sin apenas aceite garantizando que los alimentos no se peguen.
- Mango fabricado en madera de roble, totalmente plegable y ultrarresistente al calor.
- Máxima eficiencia y ahorro de energía; su fondo difusor FULL INDUCTION está especialmente diseñado para repartir el calor de manera rápida y uniforme a lo largo de toda la superficie (base + paredes), consiguiendo así que los alimentos se cocinen de forma uniforme por toda la superficie.
- Apta para todo tipo de fuegos: gas, eléctrica, vitrocerámica e inducción.

FR

- Poêle-grill fabriquée en fonte d'aluminium de la plus grande qualité.
- Finition antiadhésive bi-couche de grande qualité et 100% sans PFOA. Sans matériaux toxiques, métaux lourds, dissolvants ni substances chimiques.
- Conçue pour une cuisine saine : permet de cuisiner sans à peine utiliser d'huile en garantissant que les aliments ne collent pas.
- Manche fabriqué en chêne, entièrement pliable et ultra résistant à la chaleur.
- Efficacité et économies d'énergie maximales : son fond diffuseur FULL INDUCTION a été spécialement conçu pour répartir la chaleur de façon rapide et uniforme sur toute la surface (base + parois), obtenant ainsi une cuisson des aliments uniforme sur toute la surface.
- Apte pour tout type de cuisinières : gaz, électrique, vitrocéramique et induction.

EN

- Grill frying pan made of top quality cast aluminium.
- It has a high quality bi-layer non-stick coating that is 100% PFOA free. It's free of toxic materials, heavy metals, solvents and chemical substances.
- Designed for healthy cooking, it lets you cook with practically no oil with the assurance that food will not stick.
- It has a wooden handle that can be folded and is ultra heat resistant.
- Maximum efficiency and energy savings. The FULL INDUCTION diffuser bottom is specially designed to distribute heat quickly and evenly through the entire surface (base + sides). That means food is cooked evenly on the entire surface.
- It's suitable for all kinds of cookers: gas, electric, vitroceramic and induction.

Mango abatible de madera de roble
Wooden folded handle



Grill

Grill · Grill Induktionfähig
Grill · Grelhador

Ref	€	cm	Øh (cm)	e (mm)	U.Venta
25144	27,60	24x24	3,7	1,7	1
25148	33,60	28x28	3,8	1,7	1



Grill liso

Grill lisse · Grill Induktionfähig, glatt
Grill flat · Grelhador liso

Ref	€	cm	Øh (cm)	e (mm)	U.Venta
25154	27,60	24x24	3,7	1,7	1
25158	33,60	28x28	3,8	1,7	1

JAVA

Colección



ES

- Fabricada en aluminio forjado de máxima calidad.
- Antiadherente interior y exterior reforzado a base de partículas de piedra.
- Ecológico, libre de materiales tóxicos y pesados. Libre de PFOA.
- Fondo FULL INDUCTION compatible con todas las fuentes de calor, incluida la inducción. Excelente conductividad térmica.

FR

- Fabriquée en aluminium forgé de la plus grande qualité.
- Antiadhésif intérieur et extérieur renforcé à base de particules de pierre.
- Écologique, exempt de matériaux toxiques et lourds. Sans PFOA.
- Fond « FULL INDUCTION » compatible avec toutes les sources de chaleur, y compris l'induction. Excellente conductivité thermique.

EN

- Made of high quality forged aluminum.
- Reinforced non-stick coating inside and outside using stone particles.
- Ecological, free of toxic and heavy materials. PFOA free.
- FULL INDUCTION base that can be used with all kinds of heat sources, including induction cookers. Excellent thermal conductivity.



Sartén
Poêle · Pflanne
Frying-pan · Sertā

Ref	€	ØD (cm)	Ød (cm)	h (cm)	e (mm)	U.Venta
26816	14,00	16	13,0	4,0	3,0	6
26818	15,00	18	13,8	4,0	3,0	6
26820	16,40	20	15,6	4,0	3,0	6
26822	18,50	22	17,4	4,5	3,0	6
26824	20,10	24	19,0	4,5	3,0	6
26826	22,20	26	20,4	5,0	3,0	6
26828	24,10	28	22,4	5,5	3,0	6
26830	26,80	30	23,7	5,5	3,0	6
26832	37,20	32	25,0	5,5	3,0	6



Sartén honda
Poêle profonde · Tiefe Pflanne
Deep frying-pan · Sertā funda

Ref	€	ØD (cm)	Ød (cm)	h (cm)	e (mm)	U.Venta
26834	21,40	24	18,5	6,5	3,0	1
26838	25,30	28	22,2	7,0	3,0	1



Crepera
Crépière · Crêpes Pflanne
Crepiere · Crepeira

Ref	€	ØD (cm)	Ød (cm)	h (cm)	e (mm)	U.Venta
26844	18,60	24	21,6	2,0	3,0	1



Wok
Wok · Wok
Wok · Wok

Ref	€	ØD (cm)	Ød (cm)	h (cm)	e (mm)	U.Venta
26848	23,80	28	17,0	8,0	3,0	1



Grill
Grill · Grill Induktionfähig
Grill · Grelhador

Ref	€	cm	Ød (cm)	h (cm)	e (mm)	U.Venta
26858	27,10	28 x 28	24,2	4,5	3,0	1

FOGO Set

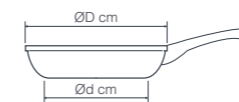

Set 2 sartenes

Set 2 poêles · Set 2 Bratpfannen
Set 2 frying pans · Conjunto 2 sertās

Ref	€	ØD (cm)	Ød (cm)	h (cm)	e (mm)	U.Venta
26400	33,80	20	14,5	4,2	3,0	1
		24	18,0	4,7	3,0	



VITE Sartén

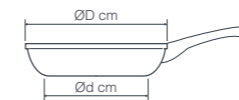

26718

Sartén VITE
Poêle · Pflanne
Frying pan · Sertā

Ref	€	ØD (cm)	Ød (cm)	h (cm)	e (mm)	U.Venta
26718	12,40	18	11,5	4,0	3,0	6
26720	13,90	20	14,3	4,0	3,0	6
26722	15,80	22	15,6	4,5	3,0	6
26724	17,40	24	17,0	4,5	3,0	6
26726	19,90	26	19,0	5,0	3,0	6
26728	22,00	28	21,5	5,0	3,0	6
26730	23,70	30	21,2	5,5	3,0	6



EASY Sartén



ES

- Fabricada en aluminio forjado de máxima calidad.
- Recubrimiento antiadherente Whitford reforzado de máxima calidad y libre de PFOA.
- Antiadherente interior reforzado a base de partículas de piedra.
- Fondo FULL INDUCTION compatible con todas las fuentes de calor, incluida la inducción. Excelente conductividad térmica.

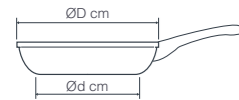

Sartén
Poêle · Pflanne
Frying-pan · Sertã

Ref	€	ØD (cm)	h (cm)	e (mm)	U.Venta
27018	20,50	18	4,0	3,0	6
27020	21,30	20	4,0	3,0	6
27022	23,10	22	4,5	3,0	6
27024	25,00	24	4,5	3,0	6
27026	27,20	26	5,0	3,0	6
27028	29,80	28	5,5	3,0	6
27030	32,60	30	5,5	3,0	6
27032	34,50	32	6,0	3,0	6

FR

- Fabriquée en aluminium forgé de la plus grande qualité.
- Revêtement antiadhésif renforcé Whitford de qualité supérieure et sans PFOA.
- Antiadhésif intérieur renforcé à base de particules de pierre.
- Fond « FULL INDUCTION » compatible avec toutes les sources de chaleur, y compris l'induction. Excellente conductivité thermique.

EN

- Made of high quality forged aluminum.
- Top quality Whitford reinforced non-stick coating and PFOA-free.
- Reinforced non-stick coating inside using stone particles.
- FULL INDUCTION base that can be used with all kinds of heat sources, including induction cookers. Excellent thermal conductivity.

Mango de fundición de acero inoxidable
Cast stainless steel handle



FIT Sartén



ES

- Gracias al tratamiento electrolítico empleado en su proceso de fabricación, el aluminio se sella completamente y se endurece para que no pase a los alimentos.
- Gran durabilidad y ultrarresistente: superficie robusta altamente resistente a roces, deformación y corrosión.



Sartén
Poêle · Pflanne
Frying pan · Sertã

Ref	€	ØD (cm)	Ød (cm)	h (cm)	L	e (mm)	U.Venta
48720	32,30	20	15,0	4,0	0,90	4,5	6
48724	40,40	24	18,0	4,5	1,50	4,5	6
48728	48,20	28	22,0	5,0	2,70	4,5	6

FR

- Grâce au traitement électrolytique utilisé lors de son processus de fabrication, l'aluminium est totalement scellé et durcit pour ne pas pouvoir atteindre les aliments.
- Grande durabilité et ultra résistante : Surface robuste hautement résistante aux rayures, à la déformation et à la corrosion.

EN

- Because of the electrolytic treatment used in the manufacturing process, the aluminium is completely sealed and hardened so no metal is passed on to the food.
- Extremely durable and ultra-high strength: It has a robust surface that is highly resistant to abrasion, warping and corrosion.

PPG QuanTanium™
Titanium-reinforced non-stick coating

- Antiadherente QuanTanium® reforzado con partículas de titanio; libre de materiales tóxicos y pesados, ecológico y libre de PFOA.
- Antiadhésif QuanTanium® renforcé avec des particules de titane ; sans matériaux toxiques ni métaux lourds, écologique et sans PFOA.
- QuanTanium® non-stick reinforced with titanium particles; free from toxic and heavy materials, environmentally friendly and PFOA-free.

VOGA Sartén



ES

- Fabricado en aluminio forjado, acabado fuerte y robusto.
- Calentamiento rápido y uniforme.
- Recubrimiento antiadherente ILAG:ULTIMATE (Tricapa) de gran calidad ultrarresistente y de uso intensivo.
- Mango de acero inoxidable, no se calienta.

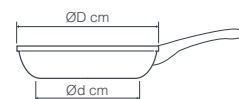

Sartén
Poêle · Pflanne
Frying-pan · Sertã

Ref	€	ØD (cm)	Ød (cm)	h (cm)	e (mm)	U.Venta
24720	32,50	20	14,6	4,5	4,0	6
24722	35,50	22	15,6	5,0	4,0	6
24724	39,80	24	17,7	5,0	4,0	6
24726	44,00	26	18,8	5,5	4,0	6
24728	47,10	28	20,4	6,0	4,0	6
24732	54,90	32	23,3	6,5	4,0	6

FR

- Fabriquée en aluminium forgé, finition solide et robuste.
- Chauffe rapide et uniforme.
- Revêtement antiadhésif ILAG:ULTIMATE (tri-couche) de grande qualité ultra résistant et à usage intensif.
- Manche en acier inoxydable, ne chauffe pas.

EN

- Made of forged aluminium, strong and robust finish.
- Quick and even heating.
- Ultra-resistant high-quality ILAG:ULTIMATE non-stick coating (Triple-layer) for intensive use.
- Heat-resistant stainless steel handle.



LOFT Sartén



ES

- Fabricada en aluminio embutido, acabado fuerte y robusto.
- Recubrimiento antiadherente. Calidad y larga duración.
- Exterior en negro mate.
- Calentamiento rápido y uniforme.
- Mango SOFT TOUCH.

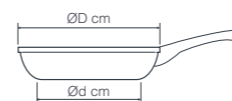

Sartén
Poêle · Pflanne
Frying pan · Sertã

Ref	€	ØD (cm)	Ød (cm)	h (cm)	e (mm)	U.Venta
24918	18,90	18	13,5	3,8	3,5	6
24920	20,70	20	14,7	4,3	3,5	6
24922	22,30	22	16,5	4,3	3,5	6
24924	24,90	24	17,6	4,8	3,5	6
24926	26,60	26	19,0	4,8	3,5	6
24928	30,70	28	22,1	5,3	3,5	6

FR

- Fabriquée en aluminium embouti, finition forte et robuste.
- Revêtement antiadhésif. Qualité et longue durée de vie.
- Extérieur en noir mat.
- Chauffe rapide et uniforme.
- Manche SOFT TOUCH.

EN

- Made from deep drawn aluminium, strong and robust finish.
- Non-stick coating. Quality and long life.
- Outside in matte black.
- Quick and uniform heating.
- SOFT TOUCH handle.

Mango SOFT TOUCH
SOFT TOUCH handle



TRIMETAL

Colección



ES

- **Cuerpo fabricado en 3 capas: acero inoxidable 18/10, aluminio, acero inoxidable 18%.**
- **La capa exterior, es de acero inoxidable con componentes ferríticos, lo que la convierte totalmente compatible con las cocinas de inducción.**
- **Los mangos están fabricados en acero inoxidable 18/10 y recubiertas con un protector térmico de silicona para facilitar un agarre perfecto y seguro.**

FR

- Corps fabriqué avec 3 couches : acier inoxydable 18/10, aluminium, acier inoxydable 18%.
- La couche extérieure est en acier inoxydable avec des composants ferritiques, ce qui lui permet d'être totalement compatible avec les cuisinières à induction.
- Les manches sont fabriqués en acier inoxydable 18/10 et recouverts d'une protection thermique en silicone pour faciliter une prise en main parfaite et sûre.

EN

- Body manufactured in a 3-layered: 18/19 stainless steel, aluminium, 18% stainless steel.
- Exterior layer, of stainless steel with ferrite materials, making it completely compatible with induction cookers.
- The grips are made in 18/10 stainless steel and covered in a silicon heat protection for easy and safe gripping.



Sartén
Poêle · Pflanne
Frying pan · Sertä

Ref	€	Ø (cm)	h (cm)	e (mm)	U.Venta
53720	57,80	20	4,5	2,3	1
53724	64,40	24	5,0	2,3	1
53728	78,90	28	5,5	2,3	1



Sartén antiadherente
Poêle antiadherent · Pflanne, Antihaft
Non-stick frying pan · Sertä anti-aderente

Ref	€	Ø (cm)	h (cm)	e (mm)	U.Venta
53721	68,00	20	4,5	2,3	1
53725	81,40	24	5,0	2,3	1
53729	102,80	28	5,5	2,3	1



Wok
Wok · Wok
Wok · Wok

Ref	€	Ø (cm)	h (cm)	e (mm)	U.Venta
53828	85,80	28	8,0	2,3	1



Wok antiadherente
Wok, Antiadherent · Wok, Antihalt
Wok, non-stick · Wok anti-aderente

Ref	€	Ø (cm)	h (cm)	e (mm)	U.Venta
53829	97,50	28	8,0	2,3	1

TRICHEF

Colección



ES

- **El aluminio interior garantiza una distribución rápida y uniforme del calor, así como un importante ahorro en el uso de la energía.**
- **Mango ergonómico fabricado en fundición de acero inoxidable 18/10 de gran calidad.**
- **Apta para todo tipo de cocinas, especialmente para la inducción.**
- **Máxima garantía en cuanto a resistencia, durabilidad e higiene.**
- **Apto para el horno (hasta 260°) y lavavajillas.**

FR

- L'aluminium intérieur garantit une distribution rapide et uniforme de chaleur, ainsi que d'importantes économies d'énergie.
- Poignée ergonomique fabriquée en fonte d'acier inoxydable 18/10 de grande qualité.
- Apte pour tous types de cuisinières, particulièrement l'induction.
- Garantie maximale en termes de résistance, durabilité et hygiène.
- Apte pour le four (jusqu'à 260°C) et le lave-vaisselle.

EN

- The aluminium layer inside ensures fast, even heat distribution to the food and significant energy saving costs.
- Ergonomic handle made of high quality 18/10 cast stainless steel.
- Suitable for all hobs, especially induction.
- Maximum guarantee in terms of strength, durability and hygiene.
- Oven (up to 260°) and dishwasher safe.

New

- 1.- Acero inoxidable 18/10 · 18/10 stainless steel
- 2.- Aluminio · Aluminium
- 3.- Acero inoxidable inducción · Induction stainless steel

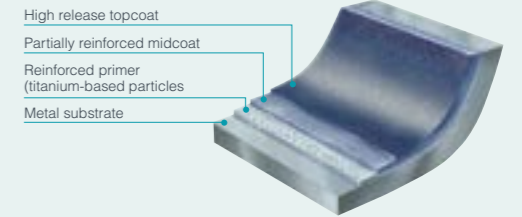
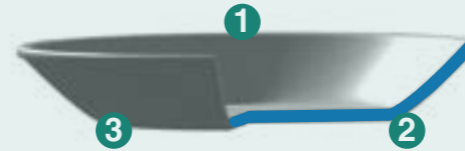

- **El aluminio interior garantiza una distribución rápida y uniforme del calor, así como un importante ahorro en el uso de la energía.**
- **Asas ergonómicas fabricadas en fundición de acero inoxidable 18/10 de gran calidad.**
- **Aptas para todo tipo de cocinas, especialmente para la inducción.**
- **Máxima garantía en cuanto a resistencia, durabilidad e higiene.**
- **Aptas para el horno (hasta 260°C) y lavavajillas.**

- **Antiadherente Quantanium® reforzado con partículas de titanio; libre de materiales tóxicos y pesados, ecológico y libre de PFOA.**
- Antiadhésif Quantanium® renforcé avec des particules de titane ; sans matériaux toxiques ni métaux lourds, écologique et sans PFOA.
- Quantanium® non-stick reinforced with titanium particles; free from toxic and heavy materials, environmentally friendly and PFOA-free.

- The aluminium layer inside ensures fast, even heat distribution to the food and significant energy saving costs.
- Ergonomic handles made of high quality 18/10 cast stainless steel.
- Suitable for all hobs, especially induction.
- Maximum guarantee in terms of strength, durability and hygiene.
- Oven (up to 260°) and dishwasher safe.



Sartén
Poêle · Pflanne
Frying pan · Sertä

Ref	€	Ø (cm)	h (cm)	e (mm)	U.Venta
60850	30,90	20	4,3	2,5	1
60854	38,60	24	4,8	2,5	1
60858	46,80	28	5,3	2,5	1



Sartén antiadherente
Poêle antiadherent · Pflanne, Antihaft
Non-stick frying pan · Sertä anti-aderente

Ref	€	Ø (cm)	h (cm)	e (mm)	U.Venta
60950	36,50	20	4,3	2,5	1
60954	44,80	24	4,8	2,5	1
60958	54,70	28	5,3	2,5	1

INOX 18/10

Colección



ES

- Fabricadas en acero inoxidable 18/10 de la mejor calidad.
- Máxima garantía en resistencia, durabilidad e higiene.
- Fondo termodifusor sandwich, distribución rápida y uniforme del calor.
- Homogeneidad y eficacia térmica.
- Cocción ultrarrápida.
- Aptas para todos los fuegos.

FR

- Fabriquées en acier inoxydable 18/10 de la meilleure qualité.
- Garantie maximale de résistance, de durabilité et d'hygiène.
- Fond thermo-diffuseur sandwich, distribution rapide et uniforme de la chaleur.
- Homogénéité et efficacité thermique.
- Cuisson ultra-rapide.
- Aptes pour tous les feux.

EN

- Made of 18/10 stainless steel of the best quality.
- Maximum guarantee in resistance, durability and hygiene.
- Heat-diffusing sandwiched base, quick and even heat distribution.
- Thermal homogeneity and efficiency.
- Ultra-rapid cooking.
- Suitable for all types of cookers.

Sartén VITROCOR

Poêle · Pfanne
Frying pan · Sertä

Ref	€	Ø (cm)	h (cm)	e (mm)	U.Venta
40619	32,90	18	4,5	0,7	1
40621	35,00	20	4,5	0,7	1
40623	36,30	22	5,0	0,7	1
40625	38,80	24	5,2	0,7	1
40627	40,00	26	6,0	0,7	1
40629	42,90	28	6,5	0,7	1



Sartén lisa HOME

Poêle, lisse · Pfanne, glatt
Frying-pan flat · Sertä

Ref	€	Ø (cm)	h (cm)	e (mm)	U.Venta
71318	37,90	18	5,5	0,7	1
71320	39,80	20	5,5	0,7	1
71322	44,30	22	5,5	0,7	1
71324	48,50	24	6,0	0,7	1
71326	53,30	26	6,0	0,7	1
71328	59,80	28	6,5	0,7	1

Sartén HOME

Poêle · Pfanne
Frying-pan · Sertä

Ref	€	Ø (cm)	h (cm)	e (mm)	U.Venta
71818	37,90	18	5,5	0,7	1
71820	39,80	20	5,5	0,7	1
71822	44,30	22	5,5	0,7	1
71824	48,50	24	6,0	0,7	1
71826	53,30	26	6,0	0,7	1
71828	59,80	28	6,5	0,7	1

New

Mango

Poignée · Griff
Handle · Cabo

	Ref	€	Color	U.Venta
A	56601	14,20	Negro · Black	1
B	56605	14,40	Azul · Blue	1
C	56603	14,40	Rojo · Red	1



Cuerpo para tartera/sartén COMBI

Corps pourplat rond/poêle · Körper für Pfanne/Pfanne
Body for round dish/frying pan · Corpo para tarteira/sertä

Ref	€	Ø (cm)	h (cm)	L	U.Venta
56720	23,70	20	4,0	1,00	1
56724	29,40	24	4,5	2,00	1
56728	39,90	28	5,0	3,00	1
56732	47,60	32	5,5	4,00	1



Cuerpo para tartera/sartén COMBI

Corps pourplat rond/poêle · Körper für Pfanne/Pfanne
Body for round dish/frying pan · Corpo para tarteira/sertä

Ref	€	Ø (cm)	h (cm)	L	U.Venta
56820	30,90	20	4,0	1,00	1
56824	37,40	24	4,5	2,00	1
56828	49,70	28	5,0	3,00	1
56832	57,70	32	5,5	4,00	1



Sartén FOODIE

Poêle · Pfanne
Frying pan · Sertä

Ref	€	ØD (cm)	Ød (cm)	h (cm)	e (mm)	U.Venta
45420	29,60	20	13,5	5,5	0,6	1
45422	31,50	22	14,5	5,5	0,6	1 New
45424	35,30	24	17,5	6,0	0,6	1
45426	37,50	26	19,0	6,0	0,6	1 New
45428	41,50	28	19,5	6,5	0,6	1
45430	42,70	30	22,0	6,5	0,6	1 New



Sartén antiadherente FOODIE

Poêle antiadherent · Pfanne, Antihafit
Frying-pan, non-stick · Sertä anti-aderente

Ref	€	ØD (cm)	Ød (cm)	h (cm)	e (mm)	U.Venta
45320	34,80	20	13,5	5,5	0,6	1
45322	36,10	22	14,5	5,0	0,6	1 New
45324	42,60	24	17,5	6,0	0,6	1
45326	43,70	26	19,0	6,0	0,6	1 New
45328	51,00	28	19,5	6,5	0,6	1
45330	52,20	30	22,0	6,5	0,6	1 New

New



Sartén ORIGIN

Poêle · Pfanne
Frying pan · Sertä

Ref	€	ØD (cm)	Ød (cm)	h (cm)	e (mm)	U.Venta
47318	24,30	18	12,5	4,00	0,6	1
47320	27,10	20	12,8	4,20	0,6	1
47322	29,20	22	16,8	4,40	0,6	1
47324	31,10	24	18,5	4,60	0,6	1
47328	34,80	28	21,2	4,80	0,6	1
47330	37,80	30	23,0	5,00	0,6	1



Sartén antiadherente ORIGIN

Poêle antiadherent · Pfanne, Antihafit
Frying-pan, non-stick · Sertä anti-aderente

Ref	€	ØD (cm)	Ød (cm)	h (cm)	e (mm)	U.Venta
47418	28,80	18	12,5	4,00	0,6	1
47420	31,90	20	12,8	4,20	0,6	1
47422	34,30	22	16,8	4,40	0,6	1
47424	36,50	24	18,5	4,60	0,6	1
47428	41,40	28	21,2	4,80	0,6	1
47430	45,10	30	23,0	5,00	0,6	1

INOX 18/10

Rustideras

Inox
18/10



ES

- Gran calidad, resistencia, tamaño y capacidad, muy útiles en la cocina.
- Ideales para la cocción de platos y asados al horno.
- Soportan sin problemas temperaturas altas.
- Excelente resistencia a la corrosión y a los ácidos alimentarios y sales.
- Asas atérmicas.

FR

- Grande qualité, robustesse, taille et capacité, très utiles dans la cuisine.
- Idéal pour la cuisson de plats et de rôtis au four.
- Supporte sans problèmes des températures élevées.
- Excellente résistance à la corrosion et aux sels et acides alimentaires.
- Poignées athermiques.

EN

- Great quality, durability, size and capacity, very useful in the kitchen.
- Ideal for cooking dishes and roasts in the oven.
- Easily withstands high temperatures.
- Excellent resistance to corrosion and to food acids and salts.
- Heat-resistant handles.



Rustidera

Plat à rotir · Lasagneform
Roaster " Assadeira

Ref	€	cm	h (cm)	U.Venta
62530	32,80	30x21	5,5	1
62535	43,30	35x26	5,5	1
62540	55,10	40x31	6,0	1



Rustidera CHEF-INOX

Plat à rotir · Lasagneform
Roaster · Assadeira

Ref	€	cm	h (cm)	e (mm)	U.Venta
50540	115,20	40x30	8,0	1,0	1
50550	152,60	50x40	8,0	1,0	1
50560	192,20	60x45	8,0	1,0	1
50570	219,60	70x45	9,5	1,0	1



Inox

Rustidera asas abatibles

Plat à gratin anse tombante · Bratpfanne mit Fallgriffen
Roaster moving handles · Assadeira asa abatível

Ref	€	cm	h (cm)	U.Venta
61530	15,90	30x22	5,0	1
61535	20,20	35x26	6,0	1
61540	25,80	40x28	6,5	1
61545	38,20	45x32	7,5	1
61550	71,10	50x36	8,0	1



Rustidera honda asas abatibles

Plat à rotir anse tombante · Bratpfanne mit Fallgriffen
Roaster moving handles · Assadeira funda asa abatível

Ref	€	cm	h (cm)	U.Venta
62530A	36,30	30x22	7,5	1
62535A	44,20	35x26	8,0	1
62540A	52,60	40x28	8,0	1
62545A	61,00	45x32	9,0	1

New

Rejilla extraíble
Removable rack



Inox

Bandeja con rejilla ESSENTIAL

Plat à four avec grille · Backblech mit Gitter
Tray with rack · Bandeja com grelha

Ref	€	cm	h (cm)	U.Venta
15562	9,90	21,5x15	2,0	1
15563	12,30	23,5x15,5	2,5	1
15566	15,10	26,5x20,5	2,5	1

- Bandeja con rejilla extraíble fabricada en acero inoxidable de gran calidad.
- Borde de acero encapsulado reforzado que evita la deformación.
- Alta conductividad térmica: distribuye el calor de manera uniforme proporcionando resultados de cocción óptimos.
- Funcional y versátil: Con la rejilla podrás asar todo tipo de carnes, enfriar galletas, deshidratar frutas, etc. Sin la rejilla, podrás estofar guisos, asar todo tipo de verduras incluso hornear tu bizcocho favorito.
- Apta para el horno, frigorífico y congelador.

- Plat à four avec grille amovible fabriqué en acier inoxydable de grande qualité.
- Bord en acier encapsulé renforcé qui évite la déformation.
- Haute conductivité thermique : distribue la chaleur de façon uniforme en apportant des résultats de cuisson optimums.
- Fonctionnel et versatile : le plat avec la grille vous permet de rôtir tout type de viandes, refroidir des biscuits, déshydrater des fruits, etc. Le plat sans la grille vous permet de préparer des ragoûts, de griller tout type de légumes, et même de faire cuire votre gâteau préféré.
- Apte pour le four, le réfrigérateur et le congélateur.

- High quality stainless steel tray with removable rack.
- Reinforced encapsulated steel rim to prevent warping.
- High thermal conductivity for even heat distribution and optimum cooking results.
- Highly functional and versatile: use the rack to roast all kinds of meat, to cool biscuits, dehydrate fruit, etc., or remove it to make casseroles, roast all kinds of vegetables and even bake your own favourite sponge cake!
- Oven, fridge and freezer safe

Rustideras - Horno
Roasting pans - Oven

ALUMINIO

Rustideras



ES

- Rustideras fabricadas en aluminio de máxima calidad.
- Distribución homogénea del calor por toda la superficie.
- Recubrimiento antiadherente de gran calidad, resistente a arañazos y ralladuras.
- Ecológico, libre de materiales tóxicos y pesados. Libre de PFOA.
- Robustas y resistentes a la deformaciones y a la abrasión.
- Ideal para hornear y gratinar todo tipo de alimentos.
- Asas diseñadas para un agarre seguro y cómodo.
- Fácil de limpiar.

FR

- Plat à rôtir fabriqué en aluminium de la plus grande qualité.
- Distribution homogène de la chaleur sur toute la surface.
- Revêtement antiadhésif de grande qualité, résistant aux rayures.
- Écologique, sans matériaux toxiques ni métaux lourds. Sans PFOA.
- Finition intérieure et extérieure noir mat.
- Robuste et résistant à la déformation et à l'abrasion.
- Idéal pour une utilisation au four et pour gratiner tout type d'aliments.
- Poignées conçues pour une prise en mains sûre et pratique.
- Facile à nettoyer.

EN

- The roasting tin is made of top quality aluminium.
- Heat is distributed evenly over the entire surface.
- It has a high quality non-stick coating that is scratch and scrape resistant.
- It's environmentally friendly and free of toxic materials and heavy metals. It's PFOA free.
- The inside and outside have a matte black finish.
- It's sturdy and resists warping and scratches.
- It's perfect for baking and cooking all kinds of foods au gratin.
- The handles are designed for a safe and comfortable grip.
- It's easy to clean.

Asa de tubo de acero inoxidable 18/10
Handles in a 18/10 stainless steel tube

Aluminio puro (99,5%)
Made in pure (99.5%) aluminium



Rustidera con asas fijas

Plat à rotir anse fixe · Bratpfanne m. feststehenden Griffen
Roaster fix handle · Assadeira com asa fixa

Ref	€	cm	h (cm)	e (mm)	L	U.Venta
20540F	53,90	40x30	6,2	2,5	7,45	1
20545F	57,80	45x32	6,2	2,5	10,40	1
20550F	72,60	50x35	7,0	3,0	12,60	1
20555F	78,80	55x37	7,7	3,0	16,30	1
20560F	85,30	60x40	7,7	3,0	18,95	1
20565F	94,80	65x43	7,9	3,0	24,30	1
20570F	100,30	70x45	9,0	3,0	28,65	1

Rustidera con asas abatibles

Plat à rotir anse tombante · Bratpfanne mit Fallgriffen
Roaster moving handle · Assadeira com asa abatível

Ref	€	cm	h (cm)	e (mm)	L	U.Venta
20540A	53,90	40x30	6,2	2,5	7,45	1
20545A	57,80	45x32	6,2	2,5	10,40	1
20550A	72,60	50x35	7,0	3,0	12,60	1
20555A	78,80	55x37	7,7	3,0	16,30	1
20560A	84,70	60x40	7,7	3,0	18,95	1
20565A	94,80	65x43	7,9	3,0	24,30	1
20570A	100,30	70x45	9,0	3,0	28,65	1



Fondo Full Induction
Full Induction bottom

Rustidera aluminio fundido antiadherente

Plat à gratin en aluminium fondu, antiadherent · Bratpfanne, Aluminium, Antihaft
Aluminium cast roaster, non-stick · Assadeira alumínio fundido anti-aderente

Ref	€	cm	h (cm)	U.Venta
25534	60,40	34x28	8	1



Rustidera antiadherente INTENSE

Plat à rotir antiadherent · Lasagneform, AntihaffNon-stick
roasterAssadeira anti-aderente

Ref	€	cm	h (cm)	e (mm)	U.Venta
15720	14,20	20x15	4,7	1,50	1
15725	16,90	25x19	5,0	1,95	1
15730	22,80	30x22	5,7	3,00	1
15735	30,80	35x26	6,3	4,50	1

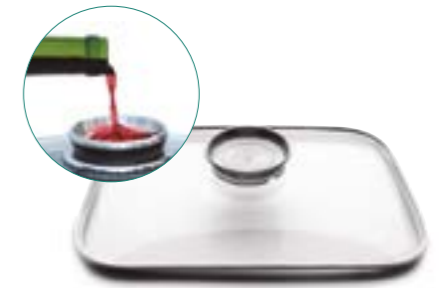

* Para la rustidera 25534 · For the 25534 roaster

Tapa de cristal rustidera

Couvercle en verre pour plat à rôtir · Deckel Glas für Bratpfanne
Lid glass for roaster · Tampa de vidro para assadeira

Ref	€	cm	h (cm)	U.Venta
25539	14,60	34x28	8	1



Rustidera antiadherente con asas abatibles ROBUST

Plat à rotir a/tombante, antiadherent · Bratpfanne mit Fallgriffen, Aluminium, Antihaff
Roaster Robust moving handle, non-stick · Assadeira c/asa abatível anti-aderente

Ref	€	cm	h (cm)	U.Venta
23540A	61,60	40x30	6,2	1
23550A	75,00	50x35	7,0	1

New



Bandeja MASTER

Plateau · Platte
Tray · Bandeja

Ref	€	cm	h (cm)	U.Venta
68465	23,10	45x33	5,0	1
68466	24,10	53x38	2,5	1

- Calidad premium: Fabricada en aluminio natural; 99,5% de pureza.
- Garantiza una conductividad térmica superior, con una distribución homogénea del calor permitiendo así que todas las elaboraciones se doren y se horneen de forma uniforme.
- Especialmente diseñadas para profesionales de la repostería, cocinas exigentes y de alta producción.
- Ligera, resistente e indeformable, fácil manejo.
- Limpieza: Se recomienda lavarla a mano con un jabón y una esponja no abrasivos. No apto para el lavavajillas.
- Consejos de uso: se recomienda usar tanto papel / tapete para hornear.

- Qualité premium : Fabriqué en aluminium naturel ; 99,5% de pureté.
- Garantit une conductivité thermique supérieure avec une distribution homogène de la chaleur, permettant ainsi à toutes les préparations culinaires de dorer et cuire de façon uniforme.
- Spécialement conçu pour les professionnels de la pâtisserie, les cuisines exigeantes et de grande production.
- Léger, résistant et indéformable ; facile à manipuler.
- Nettoyage : il est recommandé de le laver à la main avec du savon et une éponge non abrasifs. Ne peut pas aller au lave-vaisselle.
- Conseils d'utilisation : il est recommandé d'utiliser du papier sulfurisé ou un tapis de cuisson pour cuire les aliments.

- Premium quality: made from 99.5% pure natural aluminium.
- Guarantees excellent thermal conductivity and homogeneous heat distribution, allowing all baked goods to brown and bake evenly.
- Specially designed for professional bakers, demanding chefs and busy, high output kitchens.
- Lightweight, robust, non-deformable and easy to handle.
- Cleaning: cleaning by hand with detergent and a non-abrasive sponge is recommended. Not dishwasher safe.
- Instructions for use: baking mats and baking paper are both recommended.

HORNO

Parrillas · Placas · Pinzas



Parrilla

Grille · Gitter, Rost
Grate · Grelha

Ref	€	cm	h (cm)	U.Venta
68741	29,80	60x40	0,8	1

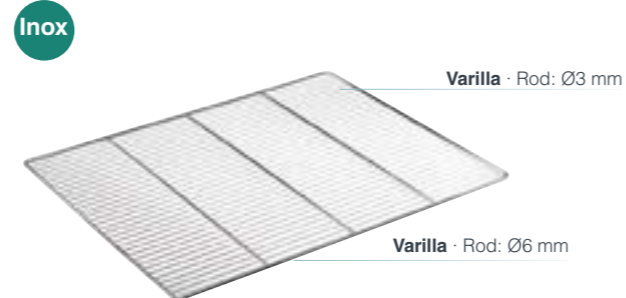

Parrilla

Grille · Gitter, Rost
Grate · Grelha

Ref	€	cm	Cubeta	U.Venta
66920	53,60	65X53	2/1	1
66921	20,60	53X32,5	1/1	1



Placa horno aluminio antiadherente

Plaque à four aluminium anti-adhésif teflon · Backblech, Aluminium, Teflon
Teflon non-stick coated oven aluminium tray · Placa forno alumínio anti-aderente

Ref	€	cm	h (cm)	U.Venta
68660	37,20	60x40	1,0	1
68659	33,80	GN 1/1	1,0	1



Placa horno acero negro

Plaque à four toile noire · Backblech, Schwarzstahl
Baking sheet black steel · Placa de forno aço negro

Ref	€	cm	h (cm)	U.Venta
68640	36,60	60x40	0,8	1



Placa horno

Plaque à four · Backblech
Baking sheet · Placa de forno

Ref	€	cm	h (cm)	U.Venta
68740	44,20	60x40	0,8	1
68739	34,20	GN 1/1	0,8	1



Placa horno

Plaque à four · Backblech
Baking sheet · Placa de forno

Ref	€	cm	h (cm)	U.Venta
68641	34,70	60x40	0,8	1
68642	28,00	GN 1/1	0,8	1



Pinza para horno y bandeja GN

Pince inox pour bac Gastronorm · Zange für GN Behälter
Tong GN tray · Pinça para forno e bandejas GN

Ref	€	L (cm)	U.Venta
A 62989	17,00	20	12
B 62998	17,00	20	12

Con silicona · With silicone

HORNO

Cordel · Tapetes · Láminas



Cordel cocina

Fil de cuisine · Küchenschnur
Kitchen string · Fio de cozinha

Ref	€	m	U.Venta
61414	6,00	80	6

Incluye · Includes:
1.- Tablas de conversión de temperatura (°C / °F)
2.- Peso (gr / oz)
3.- Volumen ml / floz / pt
4.- Longitud (mm / inch)
5.- Reglas laterales (cm / inch)

Flexible, antiadherente y reutilizable
Flexible, non-stick and reusable



Tapete de silicona impreso

Tapis en silicone imprime · Bedruckte Silikonmatte
Printed silicon mat · Tapete de silicone impreso

Ref	€	cm	U.Venta
66759	28,90	60x40	1



· Fabricado en rayón.
· Para bridar, albardar, atar asados y rellenos.
· Con soporte de almacenaje.
· Apto para horno. Temperatura max. 230°C

· Fabriqué en rayonne.
· Pour ficeler, barder, attacher les rôtis et les aliments farcis.
· Avec support de stockage.
· Convient pour le four. Température max. 230°C

· Made of Rayon.
· For tying, wrapping and trussing roasts and stuffing.
· With storage support.
· Oven safe. max temperature 230°C.

Flexible, antiadherente y reutilizable
Flexible, non-stick and reusable



Tapete de silicona

Tapis en silicone · Backblech-Auflage Silikon
Silicone covering · Tapete de silicone

Ref	€	cm	U.Venta
66749	20,30	30x40	1
66731	28,10	60x40	1
66732	20,80	52x32 GN 1/1	1



Fácil de cortar
Easy to cut

3 pcs

Láminas antiadherentes

Feuilles antiadhésif · Antihaf-Blätter
Non-stick sheets · Láminas antiaderentes

Ref	€	cm	unidades	U.Venta
66746	9,80	30x40	3	1



· Láminas de fibra de vidrio con recubrimiento antiadherente de gran calidad.
· Ideal para colocar sobre bandejas o parrillas de hornos y deshidratadores.
· Vida útil aproximadamente de 1000 hornados.
· Diseñadas para soportar temperaturas de hasta 250°C.
· Recortable para adaptar a cualquier recipiente.
· Reutilizables, para una correcta conservación se recomienda su lavado a mano.
· No aptas para el lavavajillas.

· Fiberglass sheets with non-stick coating high-quality.
· Ideal for placing on baking trays, oven racks and dehydrators.
· Can be used approximately 1,000 times.
· Designed to withstand temperatures up to 250°C.
· Can be cut to fit any container.
· Reusable; in order to keep the sheets in good condition, we recommend washing by hand.
· Non-dishwasher safe.

GUANTES DE COCINA

Colección



ES

- Materiales de alta calidad y una alta protección contra el calor por contacto.
- Permite manipular todo tipo de utensilios de cocina con total seguridad.
- Combina la resistencia al calor con la flexibilidad y comodidad.
- Manga que cubre la mayor parte del antebrazo.

FR

- Matériaux de grande qualité et une haute protection contre la chaleur pour contacts.
- Permet de manipuler tout type d'ustensiles de cuisine en toute sécurité.
- Allie la résistance à la chaleur à la flexibilité et le confort.
- Manche qui recouvre une grande partie de l'avant-bras.

EN

- High quality materials and excellent heat protection by contact.
- Lets you handle all kinds of cooking utensils with complete safety.
- Combines heat resistance with flexibility and the comfort.
- The sleeve covers most of your forearm.

New



Capa de algodón 100% adicional en el interior que aumenta la comodidad y la durabilidad
Additional 100% cotton layer inside. Provides comfort and durability

Guante de cocina RED
Gant de cuisine · Küchenhandschuh
Kitchen glove · Luva de cozinha

Ref	€	L (cm)	U.Venta
60034	12,90	27	1

New



Guante de cocina UNIVERSAL
Gant de cuisine · Küchenhandschuh
Kitchen glove · Luva de cozinha

Ref	€	L (cm)	U.Venta
A 60062	34,70	32	1
B 60068	37,70	48	1

2 pcs



Guante de cocina SAFE
Gant de cuisine · Küchenhandschuh
Kitchen glove · Luva de cozinha

Ref	€	L (cm)	U.Venta
61034	10,10	32	6



Guante de cocina SALVE
Gant de cuisine · Küchenhandschuh
Kitchen glove · Luva de cozinha

Ref	€	L (cm)	U.Venta
61033	22,30	33	1



Guante cocina textil
Gant de cuisine en coton · Küchenhandschuh, Baumwolle
Gray kitchen cotton · Luva de cozinha de algodão

Ref	€	L (cm)	U.Venta
60070	12,50	36	1

Guante algodón aluminizado

Gant de cuisine coton aluminisé · Küchhandschuh, Baumwolle, Aluminisierte
Aluminized cotton oven glove · Luva de cozinha de algodão alumínio

Ref	€	L (cm)	U.Venta
A 61024	6,00	24	1
B 61030	7,10	30	1
C 61036	7,70	36	1



ES

- Seguridad máxima: resistencia a las fuertes temperaturas.
- Presión asegurada: ranuras antideslizantes.
- Manejable: exterior del guante de silicona flexible.
- Forro interior de algodón amovible lavable (60041).
- Práctica anilla para colgar. Ambidiestro.
- Fácil de lavar y desinfectar.

FR

- Sécurité maximum: résistance aux fortes températures.
- Préhension: sécurisée: rainures antidérapantes.
- Maniabl: extérieur du gant en silicone flexible.
- Doublure en coton amovible (60041).
- Pratique anneau de suspension. Ambidextre.
- Facile à laver et désinfecter.

EN

- Maximum safety: withstands extremely high temperatures.
- Safe grip: non-slip grooves.
- Easy to handle: exterior of the glove in flexible silicone. Removable cotton lining (60041).
- Practical hanging ring. Fits both hands.
- Easy to wash and disinfect.



Forro interior de algodón extraíble lavable
Removable cotton lining



No utilizar por separado
Do not use the glove separately

Guante de cocina ORKA-TEX
Gant de cuisine · Küchenhandschuh
Kitchen glove · Luva de cozinha

Ref	€	L (cm)	U.Venta
60041	31,20	29	12



Guante de cocina ORKA
Gant de cuisine · Küchenhandschuh
Kitchen glove · Luva de cozinha

Ref	€	L (cm)	U.Venta
A 60010	37,10	29	1
B 60011	60,80	42	1

HORNO

Protectores



Protector de silicona

Protection en silicone · Silikonschutz
Silicone handle cover · Protector de silicone

Ref	€	L (cm)	U.Venta
23900	6,40	13,5	1



- Mango protector de silicona de alta calidad para sartenes.
- Fácil de colocar, se ajusta perfectamente al mango de la sartén.
- Antideslizante y termorresistente, protege de las temperaturas elevadas.
- Compatible con nuestras sartenes Robust, Ferrum, Dynamic y Tricapa Plus (Ø16-32 cm).

- High quality protective silicone handle for frying pans.
- Easy to put on, it fits the pan handle perfectly.
- Non-slip and heat-resistant, it protects from high temperatures.
- Compatible with our Ferrum, Robust, Dynamic and Tricapa Plus frying pans (Ø16-32 cm).



Manopla de silicona

Mouflette en silicone · Fäustling aus Silikon
Silicone mitten · Pegas de silicone

Ref	€	U.Venta
60014	9,90	6



Cubre asas

Couvre les poignées · Griffschutz
Covers handles · Pegas cobre-asas

Ref	€	Ø (cm)	U.Venta
R25917G	8,20	16	6
R25921G	7,80	20-24-28	6
R25933G	8,20	26x20	6
R25935G	7,80	31x25	6



Cubre asas ECO-PIEDRA

Couvre les poignées · Griffschutz
Covers handles · Pegas cobre-asas

Ref	€	Ø (cm)	U.Venta
R25436A	11,60	32-36-40	1



Asas para plancha grill

Poignées pour plaque à grill · Griffschutz for Platte Grill
Handles for grill plaque · Asas para plancha grill

Ref	€	cm	U.Venta
R25536A	4,00	36	1
R25547A	5,60	47	1



Delantal de algodón

Tablier en coton · Schürze, Baumwolle
Cotton pinafore · Avental de algodão

Ref	€	U.Venta
10004	12,00	1



Cubre asas TITANIUM

Couvre les poignées · Griffschutz
Covers handles · Pegas cobre-asas

Ref	€	Ø (cm)	U.Venta
R27520A	4,30	20	1
R27528A	4,40	24-28	1
R27732A	5,50	32-36	1



Asas para plancha grill

Poignées pour plaque à grill · Griffschutz for Platte Grill
Handles for grill plaque · Asas para plancha grill

Ref	€	cm	U.Venta
R25736A	4,00	36	1
R25747A	5,60	47	1

PARIS · MILAN · LIMA

Colección



ES

- Permiten manipular todo tipo de utensilios de cocina con total seguridad.
- Combinan la resistencia al calor con la flexibilidad y comodidad del algodón.
- Guantes con manga que cubre la mayor parte del antebrazo.
- Práctica presilla para colgarlo en la cocina.
- Delantales de gran calidad con bolsillo inferior dividido en dos partes. Unisex. Talla única ajustable.

Paris
Collection



Colección PARIS

Collection · Kollektion
Collection · Coleção

	Ref	€	cm	U.Venta
A	60080	13,50	68x83	1
B	60037	5,50	30	1
C	60044	4,30	20x20	1



FR

- Ils permettent de manipuler tous les types d'ustensiles de cuisine en toute sécurité.
- Ils allient la résistance à la chaleur à la souplesse et au confort du coton.
- Gants dont la manche couvre la majeure partie de l'avant-bras.
- Boucle pratique à suspendre dans la cuisine.
- Tabliers de haute qualité avec poche inférieure divisée en deux parties. Unisexe. Taille unique réglable.

Milan
Collection



Colección MILAN

Collection · Kollektion
Collection · Coleção

	Ref	€	cm	U.Venta
A	60081	11,20	68x83	1
B	60038	5,00	30	1
C	60045	3,90	20x20	1



EN

- For safely handling all types of kitchen utensils.
- Perfectly heat resistant together with the flexibility and comfort of cotton.
- Gloves featuring a sleeve that covers most of the forearm.
- Practical clip for hanging in the kitchen.
- Top-quality aprons featuring a bottom pocket divided into two parts. Unisex. One size fits all (adjustable).

Lima
Collection



Colección LIMA

Collection · Kollektion
Collection · Coleção

	Ref	€	cm	U.Venta
A	60082	8,90	68x83	1
B	60039	4,70	30	1
C	60046	3,50	20x20	1

PROTECCIÓN

Guantes · Delantal

Composición · Composition:
62% Polietileno / 62% Polyethylene
24% Poliéster / 24% Polyester
14% Fibra de vidrio / 14% Glass fiber



2 pcs

Guante protección

Gant de protection · Schutzhandschuh
Protection glove · Luva de protecção

Ref	€	Talla	Medida	Perim. mano	L (cm)	U.Venta
61101	19,50	M	8	182 mm	24	1
61102	19,50	L	9	192 mm	25	1
61103	19,50	XL	10	204 mm	26	1

Guantes certificados según regulación EPI EU 2016/425 módulo B
Gloves certified according to regulation EPI EU 2016/425 module B



NO lavable · NOT washable

EN 388:2016+1:2018



344 XC

CE certificate issued by CTC FRANCE

Resistencia a la abrasión 3
Abrasion resistance

Resistencia al corte 4
Blade cut resistance

Resistencia al PDM C
PDM resistance

Resistencia al desgarro 4
Tear resistance

- Ambidiestros, cómodo y ligero.
- **NO emplear con sierras giratorias o dentadas.**

- Ambidextres, pratiques et légers.
- NE PAS utiliser avec des scies giratoires ou dentées.

- Ambidextrous, comfortable and light.
- Do NOT use with rotating or toothed saws.

Inox



Guante cota

Gant en maille · Netz-Handschuh
Chainman glove · Luva de malha

Ref	€	Talla	Medidas	Perim. mano	Color	U.Venta
39169	139,10	S	7	171 mm	Blanco/White	1
39170	139,10	M	8	182 mm	Rojo/Red	1
39171	139,10	L	9	192 mm	Azul/Blue	1
39172	139,10	XL	10	204 mm	Naranja/Orange	1



UNE EN 1082

CE Directive 89/686/EEC and EN 1082-1-1996

- Guante cinco dedos con correa en la muñeca.
- Reversible para mano derecha como izquierda.
- Diseño de correa extraíble y protección completa de mano.
- Fácil lavar y desinfectar.

- Gant cinq doigts avec courroie au poignet.
- Réversible pour main droite ou gauche.
- Conception de courroie extractible et protection complète de la main.
- Facile à laver et désinfecter.

- Five-finger glove with strap on the wrist.
- Reversible for both right and left hand.
- Detachable strap and complete hand protection design.
- Easy to wash and disinfect.

Ideal para uso en mandolinas profesionales
Ideal for use in professional mandolins

Inox



Delantal cota de malla

Tablier en maille · Kettenhemb Schürze
Metal butcher's apron · Avental de malha

Ref	€	cm	Perímetro	U.Venta
39165	322,40	80x55	95-145 cm	1

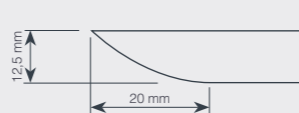

UNE EN 1082

EN ISO 13998: 2003
NIVEL / LEVEL: 2

- Ajustable gracias a sus tirantes verticales y horizontales.
- Conviene asegurarse de que las medidas del cuchillo empleado no sean inferiores a:

- Ajustable grâce à ses bandes verticales et horizontales.
- Il convient de s'assurer que les dimensions du couteau utilisé ne sont pas inférieures à :

- Adjustable thanks to its vertical and horizontal straps.
- Care must be taken to ensure that the knife used does not measure less than:

RELOJES DE COCINA

Colección



ES

- Gracias a su parte posterior magnética podrá colocar el reloj de cocina en cualquier parte metálica de su cocina.
- Alarma acústica programable.

FR

- Grâce à sa partie arrière magnétique, le minuteur peut être placé sur n'importe quelle partie métallique de la cuisine.
- Alarme acoustique programmable.

EN

- Thanks to the magnet on the back, the kitchen timer can be placed on any metal surface in the kitchen.
- Programmable acoustics alarm.

IP65 12/24 Horas



Magnético
Magnet

Reloj de cocina con alarma

Minuteur de Cuisine avec Alarme · Küchen-Zeitschaltuhr mit Alarm
Kitchen Timer Alarm · Relógio de cozinha com alarme

Ref	€	cm	U.Venta
60804	38,90	13x24,5x2,5	1



Magnético
Magnet

Reloj digital de cocina con avisador acústico

Minuter Électronique · Digitale Küchen-Zeitschaltuhr mit Alarm
Digital kitchen timer w/alarm · Relógio digital de cozinha com alarme acústico

Ref	€	cm	U.Venta
60805	9,00	10,5x7	1

Magnético
Magnet



Reloj de cocina magnético

Minuteur de cuisine magnetique · Magnetküchentimer
Magnetic kitchen timer · Relógio de cozinha magnetico

Ref	€	Tiempo	cm	U.Venta
60803	10,80	60 min	9,2x3,5	1

24 Horas



Soporte plegable. Potente imán
Folding stand. Powerful magnet



Reloj de cocina con alarma

Minuteur de Cuisine avec Alarme · Küchen-Zeitschaltuhr mit Alarm
Kitchen Timer Alarm · Relógio de cozinha com alarme

Ref	€	cm	U.Venta
60802	19,60	7x1,4x5,1	1

INOXIDABLE Paelleras

Inox 18/10

Sandwich Vitro Electric Gas Induction Oven Dishwasher



Paellera con tapa CHEF-LUXE

Plat rond avec couvercle · Pflanne mit Deckel
Round dish with lid · Paelheira com tampa

Ref	€	Ø (cm)	h (cm)	e (mm)	L	U.Venta
54636	169,50	36	7,0	1,5	7,00	1
54640	206,30	40	8,0	1,5	10,00	1
54645	238,90	45	8,5	2,0	12,00	1
* 54650	301,50	50	9,0	2,0	17,00	1

* NO inducción · NON induction · NOT induction



Paellera sin tapa CHEF-LUXE

Plat rond s/couvercle · Pflanne ohne Deckel
Round dish without lid · Paelheira sem tampa

Ref	€	Ø (cm)	U.Venta
54636S	134,10	36	1
54640S	166,30	40	1
54645S	193,00	45	1
* 54650S	246,80	50	1

* NO inducción · NON induction · NOT induction



Paellera con tapa CHEF-CLASSIC

Plat rond a/couvercle · Pflanne mit Deckel
Round with lid · Paelheira com tampa

Ref	€	Ø (cm)	h (cm)	e (mm)	L	U.Venta
50624	63,00	24	6,0	0,8	2,70	1
50628	85,20	28	6,0	0,8	3,60	1
50632	110,20	32	6,0	0,8	5,00	1
50636	139,30	36	7,0	1,0	7,10	1
50640	160,60	40	8,0	1,0	10,00	1
50645	188,60	45	8,5	1,0	13,50	1
50650	244,60	50	9,0	1,0	17,60	1
* 50660	353,80	60	9,0	1,0	25,40	1

* NO inducción · NON induction · NOT induction



Paellera sin tapa CHEF-CLASSIC

Plat rond s/couvercle · Pflanne ohne Deckel
Round dish without lid · Paelheira sem tampa

Ref	€	Ø (cm)	U.Venta
50624S	48,30	24	1
50628S	68,40	28	1
50632S	87,80	32	1
50636S	112,50	36	1
50640S	130,20	40	1
50645S	152,30	45	1
50650S	200,10	50	1
* 50660S	295,50	60	1

* NO inducción · NON induction · NOT induction



Paellera sin tapa WAGNER

Plat rond s/couvercle · Pflanne ohne Deckel
Round dish without lid · Paelheira sem tampa

Ref	€	Ø (cm)	h (cm)	e (mm)	L	U.Venta
50624W	50,70	24	6,0	0,8	2,70	1
50628W	67,30	28	6,0	0,8	3,60	1
50632W	83,50	32	6,0	0,8	5,00	1
50636W	113,50	36	7,0	1,0	7,10	1
50640W	129,80	40	8,0	1,0	10,00	1
50645W	149,50	45	8,5	1,0	13,50	1
50650W	202,20	50	9,0	1,0	17,60	1
* 50660W	288,00	60	9,0	1,0	25,40	1

* NO inducción · NOT induction



Paellera sin tapa ECO-CHEF

Plat rond sans couvercle · Pflanne ohne Deckel
Round without lid · Paelheira sem tampa

Ref	€	Ø (cm)	h (cm)	e (mm)	L	U.Venta
57624	37,70	24	6,5	0,8	3,00	1
57628	52,20	28	6,5	0,8	4,00	1
57632	66,70	32	7,0	0,8	5,00	1
57636	91,80	36	7,0	1,0	7,10	1
57640	105,80	40	8,0	1,0	10,00	1

Paelleras
Paella pans



Paellera Valenciana antiadherente

Plat à paella anti-adhésif · Paellapfanne, Antihaft
Round dish for paella non-stick · Paelheira valenciana anti-aderente

Ref	€	Ø (cm)	Raciones	U.Venta
60232	77,00	32	5	1
60236	91,00	36	7	1
60240	110,00	40	9	1



Mantiene el diseño de las paelleras clásicas y elegantes
Maintains the classic and elegant paella pan design



Paellera Valenciana

Plat à paella · Paellapfanne
Round dish for paella · Paelheira valenciana

Ref	€	Ø (cm)	Raciones	U.Venta
60130	61,80	30	4	1
60134	74,40	34	6	1
60138	88,50	38	8	1
60142	108,10	42	10	1
60146	128,50	46	12	1
60150	166,40	50	14	1
60155	211,80	55	16	1
60160	263,30	60	18	1

New

- 1.- Acero inoxidable 18/10 · 18/10 stainless steel
- 2.- Aluminio · Aluminium
- 3.- Acero inoxidable inducción · Induction stainless steel

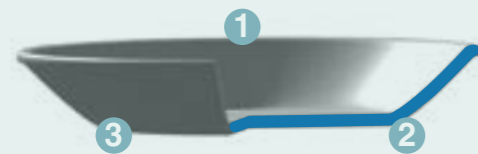

- El aluminio interior garantiza una distribución rápida y uniforme del calor, así como un importante ahorro en el uso de la energía.
- Asas ergonómicas fabricadas en fundición de acero inoxidable 18/10 de gran calidad.
- Aptas para todo tipo de cocinas, especialmente para la inducción.
- Máxima garantía en cuanto a resistencia, durabilidad e higiene.
- Aptas para el horno (hasta 260°C) y lavavajillas.

- The aluminium layer inside ensures fast, even heat distribution to the food and significant energy saving costs.
- Ergonomic handles made of high quality 18/10 cast stainless steel.
- Suitable for all hobs, especially induction.
- Maximum guarantee in terms of strength, durability and hygiene.
- Oven (up to 260°C) and dishwasher safe.



Paellera TRICHEF

Plat à paella · Pfanne
Round dish · Paelheira

Ref	€	Ø (cm)	ØBase (cm)	h (mm)	Raciones	U.Venta
60834	43,50	34	25	5,0	5	1
60840	54,60	40	30	6,0	6	1

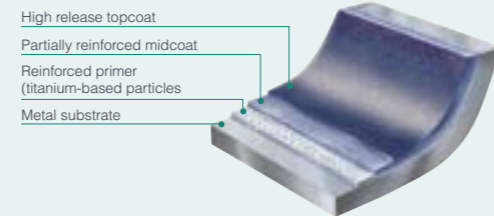

- Antiadherente QuanTanium® reforzado con partículas de titanio; libre de materiales tóxicos y pesados, ecológico y libre de PFOA.
- Antiadhésif QuanTanium® renforcé avec des particules de titane ; sans matériaux toxiques ni métaux lourds, écologique et sans PFOA.
- QuanTanium® non-stick reinforced with titanium particles; free from toxic and heavy materials, environmentally friendly and PFOA-free.



Paellera TRICHEF

Plat à paella · Pfanne
Round dish · Paelheira

Ref	€	Ø (cm)	ØBase (cm)	h (mm)	Raciones	U.Venta
60833	56,40	34	25	5,0	5	1
60839	71,30	40	30	6,0	6	1

ALUMINIO

Paelleras



Paellera ECO-PIEDRA BLACK

Plat à paella · Pfanne
Round dish · Paelheira

Ref	€	ØD (cm)	Ød (cm)	h (cm)	Raciones	e (mm)	U.Venta
25432	74,50	32	25,5	4,5	5	1,6	1
25436	79,70	36	29,5	4,5	7	2,0	1
25440	93,00	40	33,5	4,5	9	2,0	1



Asas para paellera ECO-PIEDRA

Poignées pour plat rond · Griffschutz für Pfanne
Handles for round dish · Asas para paelheira

Ref	€	Ø (cm)	U.Venta
R25436A	11,60	32-36-40	1

Incluye asas de silicona
Includes silicone handles



Paellera COCOTTE

Plat rond · Pfanne
Round · Paelheira

Ref	€	ØD (cm)	Ød (cm)	h (cm)	e (mm)	Raciones	U.Venta
25932	82,10	32	25,5	4,5	1,6	5	1
25936	95,90	36	29,5	4,5	2,0	7	1
25940	106,60	40	33,5	4,5	2,0	9	1



- Fabricadas en aluminio fundido de gran calidad y espesor, reforzadas con partículas a base de piedra y una máxima resistencia al rayado, duración y desgaste.
- Distribución homogénea del calor, permitiendo que los alimentos se cocinen rápidamente y de manera uniforme, sin apenas utilizar aceite.
- Antiadherente TRICapa de máxima calidad y ecológico. Libre de PFOA.
- Fácil limpieza interior y exterior gracias a protección antiadherente.
- Aptas para todo tipo de fuegos y se puede lavar en el lavavajillas.
- Asas fabricadas en silicona de máxima calidad, termoaislantes, altamente resistentes y ergonómicas, permiten un agarre seguro en la pieza.

- Fabriquées en fonte d'aluminium de grande qualité et épaisseur, elles sont renforcées par particules à base de pierre et confère une résistance maximale aux rayures et à l'usure pour allonger la durée de vie.
- Distribution homogène de la chaleur, permettant aux aliments de se cuire rapidement et de façon uniforme, sans à peine utiliser d'huile.
- Antiadhésif Tri-couche d'une qualité maximale et écologique, est sans PFOA.
- Intérieur et extérieur faciles à nettoyer grâce à la protection antiadhésive.
- Compatibles avec tout type de feux et peuvent être lavées au lave-vaisselle.
- Poignées fabriquées en silicone de la plus grande qualité, thermo-isolantes, hautement résistantes et ergonomiques, qui permettent de tenir l'ustensile en toute sécurité.

- Made in high quality and thickness cast aluminium, it is reinforced with stone-based particles and maximum scratch and wear resistance and durability.
- Allows for a homogeneous heat distribution, allowing the food to cook quickly and uniformly, without barely any oil.
- Its high quality and eco-friendly non-stick coating TRICapa is PFOA-free.
- Easy to clean interior and exterior with its non-stick protection.
- Suitable for all range cookers and they are dishwasher safe.
- Heat insulating, highly resistant, ergonomic handles made of high quality silicone which provide a secure grip on pots and pans.

- Garantizan la absorción y distribución uniforme del calor, sin puntos de sobrecalentamiento.
- La distribución del calor uniforme por toda la pieza hace que los alimentos no pierdan su jugo durante la cocción, conservando así todos sus nutrientes y vitaminas.
- Fondo difusor FULL INDUCTION; asegura un rendimiento óptimo en todo tipo de cocinas, con un reparto de calor inmejorable logrando la máxima eficiencia y ahorro de energía.
- Perfectas para arroces, carnes, pescados, legumbres, verduras, guisos, cremas, salsas, sopas, etc.
- Revestimiento antiadherente Xylan Plus.
- Diseño atractivo y funcional.
- Compatibles con todo tipo de cocinas, incluida la inducción.

- Garantit l'absorption et la distribution uniforme de la chaleur, sans points de surchauffe.
- La répartition uniforme de la chaleur dans toute la pièce signifie que les aliments ne perdent pas leur jus pendant la cuisson, préservant ainsi tous leurs nutriments et vitamines.
- Fond diffuseur FULL INDUCTION; garantit un rendement optimal sur tout type de feux, avec une répartition de la chaleur unique, obtenant ainsi une efficacité et une économie d'énergie maximales.
- Parfait pour le riz, la viande, le poisson, les légumineuses, légumes, ragoûts, crèmes, sauces, soupes, etc.
- Revêtement antiadhésif Xylan Plus.
- Conception attrayante et fonctionnelle.
- Compatible avec tout type de feux, y compris l'induction.

- It guarantees the absorption and uniform distribution of heat, without overheating points.
- The uniform distribution of heat throughout the product makes keep its juices during cooking, preserving all its nutrients and vitamins.
- The FULL INDUCTION diffuser bottom ensures optimal performance on all kinds of cookers with unbeatable heat distribution that achieves maximum efficiency and energy savings.
- Ideal product for: rice, meats, fish, beans, vegetables, stews, creams, sauces, soups, etc.
- Non-stick coating Xylan Plus.
- Attractive design and great functionality.
- It's compatible with all kinds of cookers, including induction.



Paellera CHEF-ALUM.

Plat rond · Pflanne
Round · Paelheira

Ref	€	Ø (cm)	h (cm)	e (mm)	L	U.Venta
20628	41,80	28	7,0	2,5	4,30	1
20630	44,40	30	6,5	2,5	4,75	1
20632	47,50	32	7,0	2,5	5,50	1
20634	50,20	34	7,0	2,5	6,35	1
20636	53,10	36	7,5	2,5	7,45	1
20638	53,90	38	7,5	2,5	8,60	1
20640	63,40	40	8,0	3,0	10,05	1
20645	69,30	45	8,0	3,0	12,50	1
20650	80,80	50	8,0	3,5	15,50	1
20660	115,50	60	10,0	4,5	28,00	1



Paellera ROBUST

Plat rond · Paellapfanne
Round dish · Paelheira

Ref	€	Ø (cm)	h (cm)	U.Venta
23724	22,80	24	4,00	1
23728	29,90	28	4,50	1
23732	35,20	32	5,00	1
23736	42,50	36	5,50	1
23740	52,60	40	6,00	1



Paellera antiadherente STEEL

Plat à paella, antiadhésive · Paellapfanne, Antihaf
Round dish for paella, non stick · Paelheira anti-aderente

Ref	€	Ø (cm)	Raciones	U.Venta
60127	21,80	28	3	1
60131	24,60	32	5	1
60135	28,50	36	7	1
60139	32,00	40	9	1
60144	42,70	45	12	1
60149	51,60	50	14	1
60159	65,40	60	19	1

Esmalte vitrificado
Vitrified enamel



Paellera SMALT

Plat à paella · Paellapfanne, emailliert
Round dish for paella · Paelheira esmaltada

Ref	€	Ø (cm)	Raciones	U.Venta
60170	5,10	10	1	10
60172	5,70	12	1	10
60175	6,70	15	1	6
60180	8,60	20	1	6
60184	10,40	24	1	1
60188	12,70	28	3	1
60182	17,40	32	5	1
60186	19,50	36	7	1
60141	24,00	40	9	1
60151	36,80	50	14	1
60161	57,90	60	19	1

MASTER Paelleras



Paellera STEEL PRO

Plat à paella · Paellapfanne
Round dish for paella · Paelheira

Ref	€	Ø (cm)	h (cm)	Raciones	U.Venta
63621	6,70	20	4,0	1	6
63623	6,80	22	3,5	1	6
63625	7,10	24	3,7	1	6
63627	7,80	26	3,7	2	6
63629	8,10	28	4,1	3	6
63631	8,80	30	4,2	4	6
63633	9,80	32	5,0	5	6
63635	10,60	34	4,6	6	6
63637	11,40	36	5,0	7	1
63639	12,80	38	5,0	8	1
63641	13,90	40	5,0	9	1
63643	16,00	42	5,0	10	1
63647	18,00	46	5,0	12	1
63651	21,40	50	5,5	14	1
63656	35,00	55	5,5	16	1
63661	41,40	60	5,0	19	1
63666	51,30	65	5,5	22	1
63671	73,00	70	6,0	25	1
63681	100,30	80	7,1	40	1
63691	140,10	90	8,0	50	1
63115	417,60	115	9,0	120	1
63130	867,10	130	12,0	200	1

Con 4 asas
With 4 handles

Con 6 asas
With 6 handles



- Clásicas paelleras fabricadas en acero.
- Máxima garantía en cuanto a resistencia, durabilidad e higiene.
- Ideales para eventos, catering y fiestas populares.
- Aptas para cocina de gas, vitrocerámica, eléctrica.
- Disponible en diferentes diámetros.

- Poêles à paella classiques en acier.
- Garantie maximale en termes de résistance, durabilité et hygiène.
- Idéal pour les événements, la restauration et les fêtes populaires.
- Convient aux cuisinières à gaz, vitrocéramiques et électriques.
- Disponible en différents diamètres.

- Classic paella pans made of steel.
- Maximum guarantee in terms of resistance, durability and hygiene.
- Ideal for events, catering and popular parties.
- Suitable for Gas, Vitroceramic, Electric cookers.
- Available in different diameters.

Asas de acero inoxidable
Stainless steel handles



Paellera FERRUM

Plat à paella · Paellapfanne
Round dish for paella · Paelheira

Ref	€	Ø (cm)	h (cm)	e (mm)	Raciones	U.Venta
63928	57,10	28	4,5	2,5	3	1
63932	64,70	32	4,7	2,5	5	1
63936	80,70	36	5,5	2,5	7	1
63940	88,90	40	5,5	2,5	9	1

Accesorios para paelleras

Diseñado para el soporte paellero ref.: 63700
Designed for base for burner



Paellero Gas Butano

Rechaud · Brenner
Burner · Paelheira gás butanos

Ref	€	Ø (cm)	Quemadores	Kw	Presión (mbar)	U.Venta	Paelleras recomendadas
63731	46,70	30	1	6,50	37	1	Ø36-38-40-42-46
63741	80,80	20-40	2	11,40	37	1	Ø28-30-32-34-36-46-50-55
63751	106,80	30-50	2	14,10	37	1	Ø38-40-42-46-60-65-70
63761	150,40	20-40-60	3	21,00	37	1	Ø28-30-32-34-36-46-50-55-70-80
63771	247,20	30-50-70	3	24,50	37	1	Ø38-40-42-46-60-65-70-80-90

Válido para propano y butano · NO válidas Gas Natural y Gas Ciudad
Valid for propane and butane · NOT valid Natural Gas and Gas City

Regulable para distintas medidas
Adjustable for different measures



Soporte paellero

Pied pour rechaud · Stände für Brenner
Base for burner · Cuporte paelheira

Ref	€	U.Venta
63700	46,30	1

U.P. Colección

Inox
Dishwasher

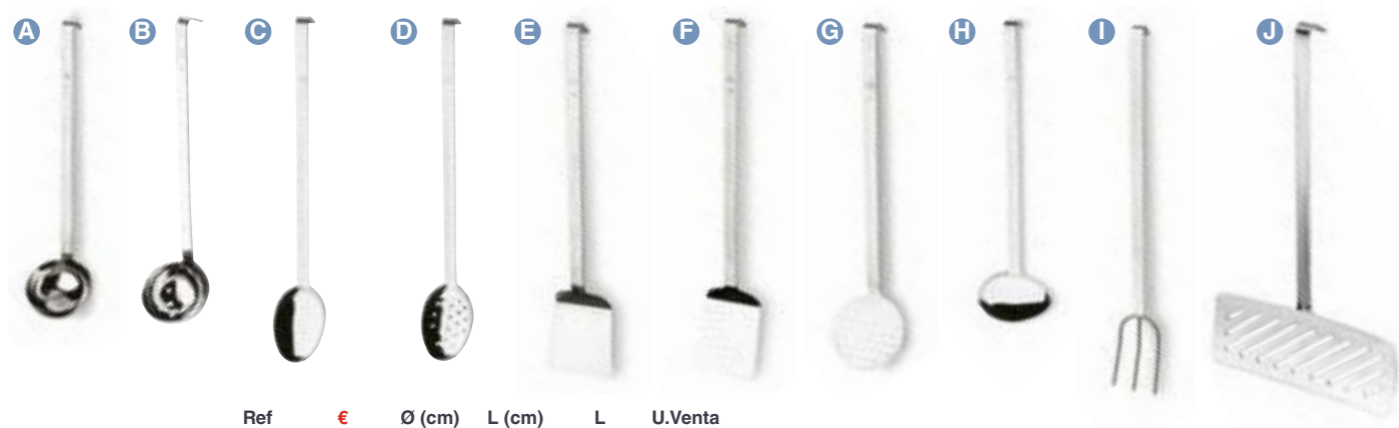

	Ref	€	Ø (cm)	L (cm)	L	U.Venta	
	60306	10,20	6,50	34,5	0,07	6	Cacillo · Louche · Ladle
	60308	11,70	8,00	38,0	0,12	6	
	60309	12,40	9,00	46,0	0,20	6	
A	60310	14,00	10,00	46,0	0,25	6	
	60312	16,40	12,00	48,0	0,50	6	
	60314	21,10	14,00	55,0	0,75	6	
	60316	21,80	16,00	55,5	1,00	6	
	61308	11,00	8	38,0	0,12	6	Cacillo perforado · Louche perforée · Perfored ladle
	61310	14,20	10	46,0	0,25	6	
	61312	16,90	12	48,0	0,50	1	
B	60507	11,00	10,5	48,0	-	1	Cuchara · Cuillère · Ladle
C	60508	13,30	7,50	48,0	-	6	Cuchara perforada · Cuillère perforee · Perforated ladle
D	61410	12,30	9x10	49,5	-	6	Espátula · Spatule · Spatula
E	61412	13,90	11x12	51,0	-	6	
F	61411	13,20	9x10	49,50	-	6	Espátula perforada · Spatule perforee · Perforated spatule
	61413	14,40	11x12	51,0	-	6	
	60408	9,70	8	35,0	-	1	Espumadera · Ecumoire · Skimmer
	60410	11,70	10	47,0	-	6	
G	60412	12,30	12	49,5	-	6	
	60414	16,40	14	57,0	-	6	
	60416	18,00	16	57,0	-	6	
H	60509	14,40	8x10	45,0	0,07	1	Cuchara oblicua · Cuillère oblique · Crosswire spoon
I	60002	15,40	7x8	57,5	2 puntas	6	Tenedor · Fourchette · Fork
	60003	17,10	7x13	7x13	3 puntas	6	
J	62988	19,90	20,5x8	37,0	12	12	Paleta de pescado · Pelle à poisson · Fish turner



Espumadera alambre

Ecumoire etamee · Fritierschaufel
Tinned skimmer · Escumadeira de arame

Ref	€	Ø (cm)	L (cm)	U.Venta
63514	11,90	14	54,0	1
63516	12,70	16	56,5	1
63518	13,10	18	56,5	1
63520	16,30	20	67,0	1
63524	18,00	24	70,5	1
63528	21,30	28	76,0	1

Alambre estañado · Fil étamé · Tinned wire



Espumadera alambre

Ecumoire à friture · Fritierlöffel
Skimmer · Escumadeira arame

Ref	€	Ø (cm)	L (cm)	U.Venta
60409	12,80	10	47,0	6
60411	13,90	12	49,0	6
60413	16,70	14	50,5	6
60415	18,40	16	52,0	6
60417	21,70	18	58,0	6
60419	25,90	20	59,0	6
60423	32,70	24	71,5	6
60427	38,30	28	74,0	6



Rasera alambre

Araignée à fil · Fritierlöffel
Mesh skimmer · Escumadeira arame

Ref	€	Ø (cm)	L (cm)	U.Venta
67410	13,90	10	37,0	6
67412	18,90	12	44,0	6
67415	30,30	15	55,5	6
67417	35,30	17	56,0	6
67420	43,30	20	58,0	6

BUFFET Colección

Inox
18/10
Dishwasher



	Ref	€	cm	L (cm)	U.Venta	
	72853	11,30	Ø6	24,5	6	Cacillo · Louche · Ladle
A	72853	11,30	Ø6	24,5	6	
B	72857	10,40	5x8	27,5	6	Cuchara · Cuillère · Ladle
C	72858	10,40	5x8	27,5	6	Cuchara perforada · Cuillère perforee · Perforated ladle
D	72854	12,60	Ø8	27,0	6	Espumadera · Ecumoire · Skimmer
E	72859	11,30	7x9	28,5	6	Espátula perforada · Spatule perforee · Perforated spatule
F	72850	11,30	5x7,5	23,5	6	Cacillo salsa · Louche sauce · Gravy ladle
G	72851	10,80	6x8,5	28,0	6	Pala ensalada · Pelle à salade · Dalat scoop
H	72856	11,30	6,5x11	31,5	6	Pala pastel · Pelete à gâteau · Cake scoop
I	72855	9,20	4,5x9	28,5	6	Tenedor · Fourchette · Fork

PROFESIONAL Colección

Inox
18/10
Dishwasher



	Ref	€	cm	L (cm)	U.Venta	
	72803	20,70	Ø10	37,0	6	Cacillo · Louche · Ladle
A	72803	20,70	Ø10	37,0	6	
B	72807	15,40	7x11	36,0	6	Cuchara · Cuillère · Ladle
C	72808	15,70	7x11	35,5	6	Cuchara perforada · Cuillère perforee · Perforated ladle
D	72806	14,90	9x12	35,0	6	Espátula · Spatule · Spatula
E	72809	16,70	9x12	39,0	6	Espátula perforada · Spatule perforee · Perforated spatule
F	72804	17,20	Ø11	37,0	6	Espumadera · Ecumoire · Skimmer
G	72805	14,00	3x10	35,5	6	Tenedor · Fourchette · Fork
H	72810	15,60	Ø6,5	29,0	6	Cacillo salsa · Louche sauce · Gravy ladle
I	72811	16,10	6,5x9	34,0	6	Servidor espaguetis · Cuillère à spaguetis · Spaguetti server

SUPER MONOBLOCK

Colección

Inox 18/10
Dishwasher



	Ref	€	cm	L (cm)	U.Venta	
A	62603	16,80	Ø10	31,0	6	Cacillo · Louche · Ladle
B	62609	14,70	7x9	31,0	1	Cacillo salsa · Louche sauce · Gravy ladle
C	62607	12,60	7x10	32,0	6	Cuchara · Cuillère · Ladle
D	62608	11,80	7x10	32,0	1	Cuchara perforada · Cuillère perforee · Perforated ladle
E	62604	16,80	Ø11	36,5	6	Espumadera · Ecumoire · Skimmer
F	62606	12,30	8x9	33,5	6	Espátula · Spatule · Spatula
G	62605	10,70	3x8	33,5	1	Tenedor · Fourchette · Fork
H	62811	14,00	Ø7,5	-	6	Servidor espaguetis · Cuillère à spaguetis · Spaguetti server
I	62601	90,10	-	-	1	Juego 5 piezas · 5 utensiles de cuisine · 5 pds. kichen tools
	62630	23,90	40	-	1	Soporte juego · Soutien · Hangring rack

Cacillo (62603)
Espumadera (62604)
Tenedor (62605)
Espátula (62606)
Cuchara lisa (62607)

Inox
Dishwasher

MONOBLOCK

Colección



	Ref	€	cm	L (cm)	U.Venta	
A	62503	8,20	Ø9	31,5	1	Cacillo · Louche · Ladle
B	62507	6,60	6,5x10	34,5	1	Cuchara · Cuillère · Ladle
C	62504	8,30	Ø11,5	35,0	1	Espumadera · Ecumoire · Skimmer
D	62506	6,40	8x10	35,5	1	Espátula · Spatule · Spatula
E	62505	5,60	2,5x10	33,5	1	Tenedor · Fourchette · Fork

DUE

Colección

Inox 18/10 PA Nylon Si Silicone Colgador Hanger Dishwasher BPA free



ES

- Colección de utensilios de nylon, ofrece un diseño versátil y cómodo.
- Mangos fabricados en acero inoxidable 18/10 de gran calidad y resistencia.
- Utensilios antiadherentes y flexibles.
- Soporta fuertes cambios de temperatura.
- Libres de BPA.

FR

- Collection d'ustensiles en nylon, offrant un design polyvalent et confortable.
- Poignées en acier inoxydable 18/10 de haute qualité et résistant.
- Utensiles antiadhésifs et flexibles.
- Résiste aux fortes variations de température.
- Sans BPA.

EN

- Nylon utensils collection, offering a versatile and comfortable versatile and comfortable design.
- Handles made of high quality and resistant 18/10 stainless steel.
- Non-stick and flexible utensils.
- Withstands strong temperature changes.
- BPA free.



	Ref	€	cm	L (cm)	U.Venta	
A	68270	8,40	7x10,5	36,5	6	Cuchara · Cuillère · Ladle
B	68271	8,60	10,5x9,5	33,5	6	Cacillo · Louche · Ladle
C	68272	8,40	10,5x10,5	36,5	6	Espumadera · Ecumoire · Skimmer
D	68274	8,60	8,5x10,5	37,5	6	Espátula · Spatule · Spatula
E	68275	8,50	8,5x10,5	37,5	6	Espátula perforada · Spatule perforee · Perforated spatula
F	68273	8,10	6,5x9,5	36,5	6	Servidor espaguetis · Cuillère à spaguetis · Spaguetti server
G	68276	8,60	8x14,5	36,5	6	Paleta de pescado · Pelle à poisson · Fish turner

BLACK Colección



125 ml



30 ml

	Ref	€	cm	L (cm)	U.Venta	
A	98903	3,80	8x9,5	31,0	12	Cacillo · Louche · Ladle
B	98907	3,80	6,5x10	30,0	12	Cuchara · Cuillière · Ladle
C	98908	3,80	6,5x10	30,0	12	Cuchara perforada · Cuillière perforee · Perforated ladle
D	98905	3,80	7,5x9	25,0	12	Cuchara salsa · Cuillière sauce · Gravy spoon
E	98906	3,80	9x10	31,0	12	Espátula perforada · Spatule perforee · Perforated spatule
F	98912	3,80	8x12	28,0	12	Espátula corta · Spatule court · Short spatule
G	98913	3,80	4x7	31,0	12	Espátula larga · Spatule longue · Long spatule
H	98904	3,80	Ø11	33,0	12	Espumadera · Ecumoire · Skimmer
I	98910	3,80	6x6,5	27,0	12	Cacillo salsa · Louche sauce · Gravy ladle
J	98911	3,80	6x8	30,0	12	Servidor espaguetis · Cuillière à spaguëtis · Spaguëtis server
K	98909	3,80	8x16	32,0	12	Paleta de pescado · Pelle à poison · Fish turner
L	98914	3,80	7x7	30,0	12	Batidor · Fouet · Whisk

ECO Colección



110 ml

40 ml

	Ref	€	cm	L (cm)	U.Venta	
A	98803	5,10	Ø9,5	29,0	12	Cacillo · Louche · Ladle
B	98807	4,30	7,5x10	30,5	12	Cuchara · Cuillière · Ladle
C	98808	4,00	7,5x10	30,5	12	Cuchara perforada · Cuillière perforee · Perforated ladle
D	98804	4,80	Ø11	31,5	12	Espumadera · Ecumoire · Skimmer
E	98806	4,40	8x10	33,0	12	Espátula perforada · Spatule perforee · Perforated spatule
F	98810	3,80	8x6,5	27,0	12	Cacillo salsa · Louche sauce · Gravy ladle
G	98811	3,90	Ø7,5	29,0	12	Servidor espaguetis · Cuillière à spaguëtis · Spaguëtis server

GREY Colección



Núcleo reforzado para una mayor resistencia sin perder flexibilidad en los bordes. Diseñados en una sola pieza, sin costuras ni grietas
Reinforced core improves strength without losing flexibility around the edges. Designed in a single piece without seams or cracks



110 ml

	Ref	€	cm	L (cm)	L (cm)	
A	64466	7,70	Ø9,5	29,0	1	Cacillo · Louche · Ladle
B	64469	6,80	5,6x9,5	29,0	1	Cuchara · Cuillière · Ladle
C	64467	7,70	Ø9	29,0	1	Espumadera · Ecumoire · Skimmer
D	64468	6,80	7,5x9,5	29,0	1	Espátula perforada · Spatule perforee · Perforated spatule
E	64470	7,50	5,5x9,5	27,0	1	Servidor espaguetis · Cuillière à spaguëtis · Spaguëtis server
F	64471	6,80	4x12,5	27,0	1	Espátula estrecha · Spatule étroite · Narrow spatule
G	64462	7,70	-	29,0	1	Pinza larga · Pince longue · Long tong
H	64463	5,50	-	27,5	1	Cuchara · Cuillière · Ladle
I	64464	5,50	5,5x8	27,5	1	Espátula · Spatule · Spatula
J	64465	5,60	-	27,5	1	Pincel · Pinceau · Brush

BRUN Colección



Fabricadas en madera de haya natural de alta calidad, acabadas con aceites naturales
Made from natural beech wood of high quality and finished with natural oils



	Ref	€	cm	L (cm)	U.Venta	
A	68175	6,00	6x10	30,0	6	Cuchara · Cuillère · Ladle
B	68176	6,30	7x10	30,0	6	Cuchara perforada · Cuillère perforee · Perforated ladle
C	68177	6,00	6,5x10	30,0	6	Espátula · Spatule · Spatula
D	68178	6,20	7,5x12	30,0	6	Espátula perforada · Spatule perforee · Perforated spatula
E	68179	6,50	6,5x10	30,0	6	Cuchara especial · Cuillère spécial · Special spoon
F	68173	7,00	8x7	30,0	6	Cuchara ensalada · Cuillère à salade · Salad spoon
G	68174	7,00	8x7	30,0	6	Tebnedor ensalada · CFourchette à salade · Salad fork

NORDIC Colección



Cabezal fabricado en nylon, resistente y duradero, libre de BPA. Mango ergonómico de madera de haya 100% natural
Head made of nylon. Strong and long lasting. BPA free. Ergonomic natural beech wood handle.



	Ref	€	cm	L (cm)	U.Venta	
A	68280	4,80	Ø9	32,0	1	Cacillo · Louche · Ladle
B	68281	4,80	6,2	34,0	1	Cuchara · Cuillère · Ladle
C	68282	4,80	8,5	35,3	1	Espátula perforada · Spatule perforee · Perforated spatula
D	68283	4,80	11,2	34,3	1	Espumadera · Ecumoire · Skimmer
E	68284	4,80	6,5	34,0	1	Servidor espaguetis · Cuillère à spaguetis · Spaguetti server

UNITE Colección



ES

- **Cabezal fabricado en silicona de grado alimentario de máxima calidad (libre de BPA).**
- **Mango ergonómico y antideslizante fabricado en madera de haya natural.**
- **PELADOR: Cabezal fabricado en polipropileno (libre de BPA) y fibra de vidrio; material ultrarresistente y duradero. Cuchilla de acero inoxidable de máxima calidad.**
- **BATIDOR: 2 en 1: bate y recoge. Varillas en acero inoxidable. Espátula de silicona inyectada en una de las varillas (certificado LFGB y libre de BPA).**

FR

- Tête fabriquée en silicone alimentaire de la plus grande qualité (sans BPA).
- Manche ergonomique et antidérapant fabriqué en hêtre naturel.
- ÉPLUCHEUSE : tête fabriquée en polypropylène (sans BPA) et fibre de verre ; matériau ultrarésistant et durable. Lame en acier inoxydable de la plus grande qualité.
- FOUET : 2 en 1 : fouetter et ramasser. Lames en acier inoxydable. Spatule en silicone injectée dans l'une des lames (certifiée LFGB et sans BPA).

EN

- Head made of top quality food grade silicone (BPA free).
- Ergonomic non-slip handle made of natural beech wood.
- PEELER: head made of polypropylene (BPA free) and fibreglass, which is ultra-durable and long lasting. Top quality stainless steel knife.
- WHISK: 2 in 1: Beat and scrape. Blades made of stainless steel. Silicone spatula injected into one of the blades (LFGB certified and BPAfree).



	Ref	€	cm	L (cm)	U.Venta	
A	68187	6,70	Ø8	31,5	1	Cacillo · Louche · Ladle
B	68185	5,80	6,7x10,5	32,0	1	Cuchara · Cuillère · Ladle
C	68195	4,30	5,6x8,5	26,5	1	Espátula · Spatule · Spatula
D	68186	5,90	7,5x10,5	33,5	1	Espátula perforada · Spatule perforee · Perforated spatula
E	68188	6,80	Ø11,5	33,5	1	Espumadera · Ecumoire · Skimmer
F	68189	5,90	5,5x9,5	32,5	1	Servidor espaguetis · Cuillère à spaguetis · Spaguetti server
G	68196	4,10	5,5x0,5	24,0	1	Pincel · Pinceau · Brush
H	68197	4,20	-	14,5	1	Pelador liso · Éplucheuse plate · Peeler plain blade
I	68198	4,20	-	14,5	1	Pelador dentado · Éplucheuse dentelé · Serrated peeler
J	68199	5,90	-	27,0	1	Batidor · Fouet · Whisk

NATURAL & BLACK

Colección



ES

- Fabricadas en fibra de madera, máxima calidad. Natural y ecofriendly.
- Robustas, resistentes y antibacterianas.
- Orificio para colgar.
- Fáciles de limpiar y aptas para el lavavajillas.

FR

- Fabriqués en fibres de bois de la plus haute qualité. Naturel et ecofriendly.
- Robusts, résistants et antibactériens.
- Orifice pour suspendre.
- Facile à nettoyer et apte pour le lave-vaisselle.

EN

- Made from wood fibre of the highest quality. Natural and ecofriendly.
- Robust, resistant and anti-bacterial.
- Hole for hanging.
- Easy to clean and dishwasher safe.



Natural

	Ref	€	L (cm)	U.Venta
A	68165	7,20	29,5	1
B	68166	6,70	29,5	1
C	68167	7,40	29,5	1
D	68168	6,90	29,5	1
E	68169	7,00	29,5	1

Black

	Ref	€	L (cm)	U.Venta	
	68265	7,60	29,5	1	Cuchara · Cuillère · Ladle
	68266	7,00	29,5	1	Espátula · Spatule · Spatula
	68267	7,70	29,5	1	Cuchara perforada · Cuillère perforee · Perforated ladle
	68268	7,20	29,5	1	Espátula perforada · Spatule perforee · Perforated spatule
	68269	7,30	29,5	1	Tenedor · Fourchette · Fork

VARIOS

Utensilios

Inox 18/10 Dishwasher

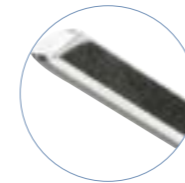

Sección cuadrada (2,5x2,5 mm) Square section



Pincho moruno (6) Inox

Brochette carre en inox. (6) · Fleischspiesse (6), Rostfrei St. steel skewersquare wire (6) · Espeto moruno Inóx (6)

Ref	€	L (cm)	U.Venta
* 62446	4,90	20,0	12
62435	5,60	30,5	12
62445	6,60	40,5	12

* Aptas para las freidoras de aire (ref: 69508-69511-69513-69515) Suitable for air fryers (ref: 69508-69511-69513-69515)



Cuchara apoya utensilios

Cuillère ramasse ustensiles · Vorlegelöffel Spoon holder utensils · Colher recolhe utensilios

Ref	€	cm	L (cm)	U.Venta
62972	11,50	25x12	25	1

AL Aluminium



Barra sujeción notas

Barre à notes · Zettelhalter Order rall · Barra fixação notas

Ref	€	L (cm)	U.Venta
60731	11,70	30,50	1
60746	15,20	46,00	1
60761	18,20	61,00	1
60776	21,00	76,00	1
60791	26,10	91,50	1

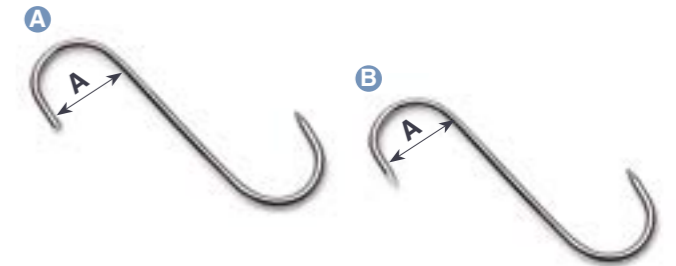

6 ganchos carnicero

6 crochets de boucher · 6-Tig Metzgerhaken 6 butchers hook · 6 ganchos de carnicero

	Ref	€	Puntas	Ø (mm)	L (cm)	A (cm)	U.Venta
A	39043	11,70	1	5	12,5	3,7	4
	39044	18,10	1	5	18,5	4,5	1
B	39047	11,80	2	5	12,5	3,7	4
	39048	18,30	2	5	18,5	4,5	1

Inox



Contenedor cubiertos

Panier à couverts · Besteckköcher Cutlery holder · Copos para talheres

	Ref	€	Ø (cm)	h (cm)	L	U.Venta
	62962	21,00	12	13,6	1,40	1
	62963	24,40	12	18,7	2,00	1

Colgador de barra

Penderie murale · Hängeleiste Wall hanger · Suporte de barra

	Ref	€	Unidades	L (cm)	U.Venta
	60740	22,50	6	40	1
A	60760	31,00	8	60	1
	60710	42,90	12	100	1
B	60700	6,70	6	-	12

Juego 6 ganchos Ensemble 6 crochets 6 hook set

INOX

Espátulas

Inox
Dishwasher



ES

- Espátulas de gran flexibilidad
- Ideal para voltear los alimentos como pescados sin romperlos.
- Su borde biselado ayuda a deslizarse debajo de los alimentos.
- El revestimiento de silicona protege las superficies antiadherentes (60726).
- Las ranuras de la espátula permiten que la grasa se escurra.
- Higiénica y fácil de utilizar y limpiar.
- Apta para el lavavajillas.

FR

- Spatules d'une grande flexibilité.
- Idéale pour retourner les aliments tels que les poissons sans les casser.
- Son bord biseauté aide à se glisser sous les aliments.
- Le revêtement en silicone protège les surfaces antiadhésives (60726).
- Les rainures de la spatule permettent à la graisse de s'écouler.
- Hygiénique et facile à utiliser et nettoyer.
- Apte pour le lave-vaisselle.

EN

- Highly flexible spatulas.
- Perfect for turning over food like fish without breaking it apart.
- Its bevelled edge helps it slide under food.
- The silicon coating protects non-stick surfaces (60726).
- The grooves on the spatula let fat flow away.
- Hygienic and easy to use and clean.
- Dishwasher safe.



Espátula flexible pescado

Spatule flexible à poisson · Fisch Schaufel, flexible
Flexible spatula to fish · Espátula flexível para peixe

Ref	€	L (cm)	U.Venta
60426	4,40	30	6



Espátula de pescado PRO

Spatule à poisson · Fischheber
Fish spatula · Espátula de peixe

Ref	€	L total (cm)	Paleta (cm)	U.Venta
60726	13,60	30	18x8	1

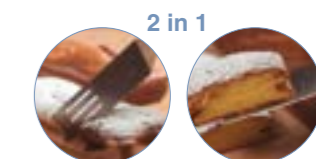

2 in 1
Cortar · Cut Servir · Serve up



Espátula serrada

Spatule à gâteau · Backschäufel
Serrated spatula · Espátula com serrilha

Ref	€	cm	U.Venta
62677	8,80	30x5,5	6

Preparación
Food processing



Espátula grill acodada

Spatule coudée our grill - Winkelpalette
Bent grillspatula - Espátula comprida grelha

Ref	€	cm	U.Venta
60434	5,90	12x27	6



Paleta triangular mango sólido

Grattoir manche noir m/solide - Bratenspachtel, Stiel
Straight Scraper/turner - Espátula triangular cabo sólido

Ref	€	cm	U.Venta
60430	6,80	10x11,5	12



Espátula lisa mango sólido

Spatule lisse m/solide - Backschaufel, f. Festsoffe
Straight spatula - Espátula lisa cabo sólido

Ref	€	cm	U.Venta
60425	4,80	7x13,5	12



Espátula larga acodada mango sólido

Spatule longue coudée m/solide - Winkelpalette, lang
Long bent spatula - Espátula comprida c/cabo sólido

Ref	€	L (cm)	U.Venta
60467	3,90	20	12
60468	4,00	25	12
60469	4,10	30	12



Espátula larga recta mango sólido

Spatule longue droite m/solide - Palette, lang, gerade
Long straight spatula - Espátula comprida c/cabo sólido

Ref	€	L (cm)	U.Venta
60461	3,70	15	12
60462	3,80	20	12
60463	3,90	25	12
60464	4,00	30	12
60465	4,10	35	12



Espátula repostería

Patisserie spatule - Gebackpalette
Pastry spatula - Espátula pasteleria

Ref	€	cm	U.Venta
60443	4,00	6,5x14,5	12



Espátula mini acodada

Mini spatule coudée - Winkelpalette Mini
Mini bent spatula - Espátula mini comprida

Ref	€	cm	U.Venta
60442	3,70	2x9	12

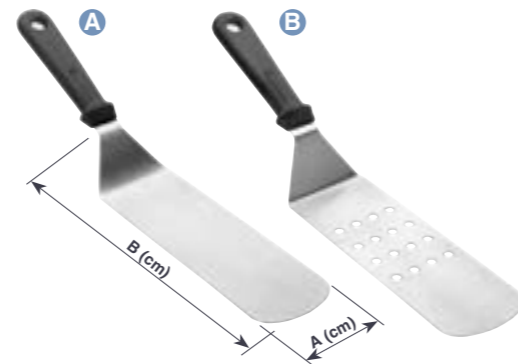

Espátula lisa mango sólido

Spatule lisse m/solide - Spachtel, mit solidem Stiel
Straight spatula - Espátula lisa cabo sólido

Ref	€	AxB (cm)	U.Venta
60420	5,30	7,5x21,5	12
60421	5,20	7,5x21,5	12



Espátula gigante inox

Spatule geante en Inox - Rührspatel, Edelstahl
St steel long handle Turner - Espátula gigante Inox

Ref.	€	L (cm)	U.Venta
61481	66,60	80	1
61421	72,80	120	1



Pala profesional polietileno

Pelle professionnelle polyéthylène - Professionnelle Ruhrspatel, Polyethylene
Polyethylene professional shovel - Pá profesional polietileno

Ref.	€	L (cm)	U.Venta
60404	77,20	81,5	1

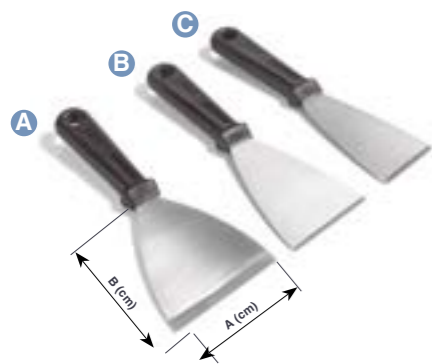

Espátula plancha mango sólido

Spatule m/solide - Grillspachtel, mit solidem Stiel
Straight spatula - Espátula grelha cabo sólido

Ref	€	A (cm)	B (cm)	U.Venta
60422	4,60	10	11,5	12
60445	3,90	8	11,5	12
60446	3,80	6	11,5	12

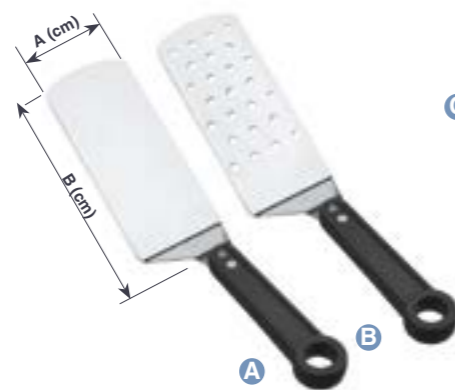

Espátula mango negro

Spatule manche noir - Schaufel mit schwarzem Stiel
Solid turner w/black H. - Espátula cabo negro

Ref	€	AxB (cm)	L (cm)	U.Venta
60435	7,60	7,5x17	35	6
60438	7,70	7,5x17	35	6

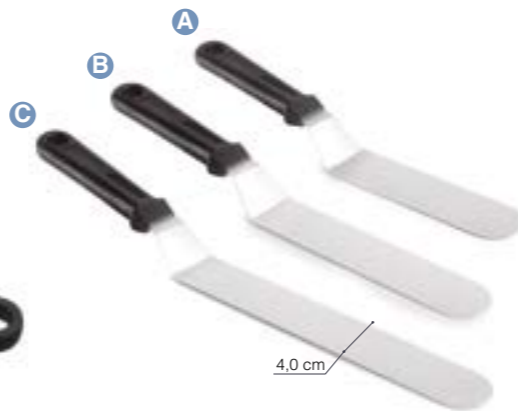

Espátula acodada

Spatule coudée - Winkelpalette
Bent spatula - Espátula comprida

Ref	€	L (cm)	U.Venta
60482	3,90	15	12
60483	4,20	19	12
60484	4,50	24	12



Pala para patatas

Pelle à pommes de terre - Kartoffelschaufel
Potato shovel - Pá de batatas

Ref	€	cm	e (mm)	NºAsas	U.Venta
62678	12,60	20x22	0,7	1	1
62679	14,80	20x22	0,7	2	1

- Palas profesionales fabricadas en acero inoxidable de gran calidad.
- Diseño trapezoidal para recoger y embolsar patatas fritas en fracciones individuales de forma rápida.
- Multifuncional: también se puede usar para servir palomitas de maíz, nueces, hielo o dulces.
- 1 o 2 mangos ergonómicos y antideslizantes ambidiestros.
- Fácil de limpiar. Aptas para el lavavajillas.

- Pelle professionnelle fabriquée en acier inoxydable de grande qualité.
- Forme trapézoïdale pour attraper et mettre rapidement en cornet des frites en portions individuelles.
- Multifonctions : peut également être utilisée pour servir du pop-corn, des noix, des glaçons ou des bonbons.
- 1 ou 2 manches ergonomiques et antidérapants pour des utilisateurs aussi bien gauchers que droitiers.
- Facile à nettoyer. Compatible avec le lave-vaisselle.

- These professional French fry scoops are made of high quality stainless steel.
- They have a trapezoidal design for scooping and bagging individual portions of French fries quickly.
- Multi-function: they can also be used to serve popcorn, nuts, ices or sweets.
- They have one or two ergonomic non-slip handles for right and left-handed users.
- Easy to clean and dishwasher safe.

PIZZA

Colección

Inox



- Cacillo para salsas fabricado en acero inoxidable de máxima calidad.
- Fondo plano para extender fácilmente y de manera uniforme las salsas sobre la base de la pizza.
- Ideal para salsa de tomate.
- 80 g de capacidad, ofrece la porción ideal para pizzas estándar de 30 cm.

- Louche à fond plat pour sauces fabriquée en acier inoxydable de la plus grande qualité.
- Fond plat pour étaler facilement et uniformément les sauces sur la base de la pizza.
- Idéale pour la sauce tomate.
- D'une capacité de 80 g, elle offre la dose idéale pour des pizzas standards de 30 cm.

- This sauce ladle is made of top quality stainless steel.
- It has a flat bottom to make it easy to spread sauce on a pizza base evenly.
- It's perfect for tomato sauce.
- The 80 g capacity is the perfect portion for standard 30 cm pizzas.



Cacillo salsa

Louche sauce · Saucengliesslöffel
Gravy ladle · Concha para molho

Ref	€	Ø(cm)	L (cm)	g	U.Venta
60562	5,60	7	27,0	80	1



- Dispone de 4 bandejas fabricadas en acero al carbono con revestimiento antiadherente, libres de PFOA, y soporte plegable de varillas de acero cromadas.
- Diámetro superior de la bandeja 29,5 cm / Diámetro interior 27cm.
- Resiste a altas temperaturas.
- Excelente conducción del calor para una cocción homogénea.
- Diseñado para cualquier horno de tamaño convencional.
- Multifuncional: las bandejas son aptas para hornear galletas, tartas, etc.

- It has four trays made of carbon steel with PFOA free non-stick coating and a collapsible support of chromed steel rods.
- Upper tray diameter 29.5 cm | Inside diameter 27 cm.
- Can withstand high temperatures, excellent heat conduction for even cooking.
- Designed for any conventionally sized oven.
- Multi-purpose: The trays can also be used to bake biscuits or cakes, etc.

New



Soporte para hornear pizzas

Support avec plaques à pizzas · Pizza Backblech
Pizza baking rack · Suporte para cozer pizzas no forno

Ref	€	Bandejas	Ø (cm)	h (cm)	U.Venta
61462	24,20	4	29,5	21	1

New



Pala pizza WOOD

Pelle pizza · Pizaofen-Schaufel
Pizza oven scoop · Pá de pizza

Ref	€	cm	L (cm)	U.Venta
61463	22,60	30,5x35,5	88	1

- Fabricada en aluminio de alta calidad con un mango de madera de caucho de 43 cm de largo.
- Ideal para pizzas, hogazas, barras de pan, pasteles, etc.
- Permite manipular los alimentos en el horno garantizando una máxima seguridad.
- Ahorra espacio en la cocina: el mango es desmontable e incluye una cuerda para colgar.

- Fabriquée en aluminium de grande qualité avec un manche en bois d'hévéa de 43 cm de longueur.
- Idéale pour les pizzas, les fougasses, les pains, les gâteaux, etc.
- Permet de manipuler les aliments dans le four en garantissant une sécurité maximale.
- Gain d'espace dans la cuisine : le manche est démontable et inclut une corde pour la suspension.

- This pizza peel is made of high quality aluminium and has a 43 cm long rubberwood handle.
- It's perfect for pizzas, loaves of bread or cakes, etc.
- You can use it to handle food in the oven with maximum safety.
- It saves space in the kitchen. The handle is removable and it has a rope to hang it with.

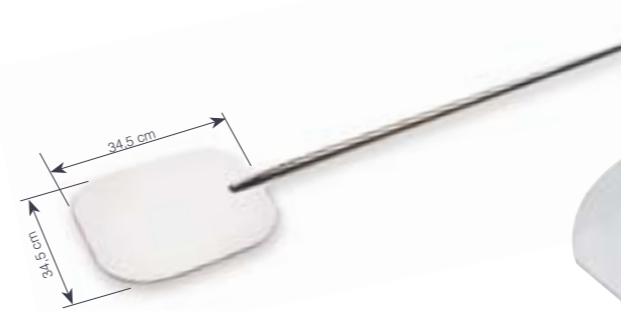

Pala pizza LUNGO

Pelle pizza · Pizaofen-Schaufel
Pizza oven scoop · Pá de pizza

Ref.	€	L (cm)	U.Venta
61460	102,90	160	1



Espátula pizza

Spatule pizza · Pizzaspatel
Pizza spatula · Espátula pizza

Ref	€	cm	U.Venta
60424	13,80	16,5x17,5x5	12



Pala pizza

Pelle pizza · Pizzaschaufel, flach
Pizza flat scoop · Espátula pizza

Ref	€	cm	U.Venta
61461	14,00	25x36	1

New



Cortapizza PRO

Roulette pizza · Pizzaschneider
Pizza cutter · Corta-Pizza

Ref.	€	L (cm)	U.Venta
61465	7,50	35	1

- Hoja fabricada en acero inoxidable extremadamente afilada de gran calidad.
- Permite realizar cortes firmes y rectos con un solo movimiento gracias a su borde curvo afilado.
- Mango ergonómico y 100% seguro.
- Multifuncional; corta pizzas, tartas, quesos, pan, etc. y pica alimentos y hierbas.
- Perfecto para uso profesional o doméstico.
- Incluye protector de hoja de polipropileno para evitar cortes y un almacenamiento seguro.

- Blade made of extremely sharp, high quality stainless steel.
- Its sharp, curved edge makes firm, straight cuts in just a single movement.
- Ergonomic handle and 100% safe.
- Multifunctional: slices pizzas, pies, cheese, bread, etc. and minces food and herbs. 35 cm cutting length.
- Perfect for professional or home use.
- Includes polypropylene blade guard to prevent cuts and for safe storage.

Cortapizza

Roulette pizza · Pizzaschneider
Pizza cutter · Corta-Pizza

	Ref	€	Ø (cm)	U.Venta
A	60429	5,00	10	12
B	67004	17,50	10	1
C	67028	12,10	10	1
D	67027	5,80	8	6

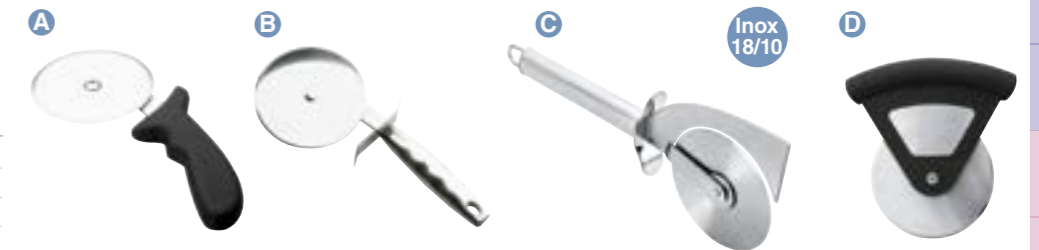

RASQUETAS

Colección



Rasqueta

Coupe pate · Schaber
Scraper · Raspador

Ref	€	cm	U.Venta
67041	25,10	13,8x13	1

- El cortador de masa está fabricado en acero inoxidable de máxima calidad con escalas de medición tanto en cm como en in. Además, dispone de un mango antideslizante y ergonómico. Está diseñado para cortar, dividir y formar masas, así como recoger harinas, etc.
- Espátula de silicona exible de gran calidad y grado alimenticio. Ideal para el empleo en superficies poco uniformes, como boles esféricos.
- El raspador está fabricado en Polipropileno + Fibra de vidrio de grado alimenticio y diseñado principalmente para decorar tartas y pasteles de forma práctica y sencilla.

Dough cutter made of top quality stainless steel with measurements marked in cm and inches. It has a non-slip ergonomic handle. It's designed to cut, divide and shape dough or pick up flour, etc.

High quality flexible food safe silicone spatula, perfect for using on uneven surfaces like spherical bowls.

Scraper made of food grade Polypropylene + Glass fiber mainly designed for decorating cakes and pies in a simple and easy way.

Diseño apilable
Stackable design



Rasqueta INOX

Coupe pate · Schaber
Scraper · Raspador

Ref	€	cm	U.Venta
67005	12,80	15x9	6
67006	12,40	15x9	6



Escala de medición
Measurement scale

Rasqueta INOX BLAK

Coupe pate · Schaber
Scraper · Raspador

Ref	€	cm	U.Venta
67029	9,40	16,5x10,5	6



Rasqueta FLEX

Coupe pate · Schaber
Scraper · Raspador

Ref	€	cm	U.Venta
67414	8,90	9x15	1

PINCELES

Colección



ES

- Para cocina o repostería.
- Prácticas espátulas o lenguas de gato para rebañar boles, cazuelas, fuentes, etc.
- Pinceles ideales para pincelar con aceites o salsas, marinar carnes o pescados, engrasar moldes, untar con aceite, huevo batido, almíbar, etc.
- No absorben olores ni sabores.

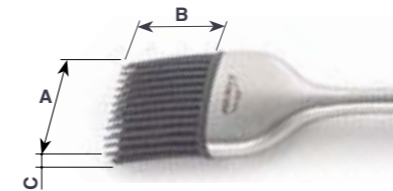

Mango de polipropileno
Polypropylene handle

Pincel VIROLA

Pinceau · Silikonpinsel
Brush · Pincel

Ref	€	A (cm)	B (cm)	C (cm)	L (cm)	U.Venta
64430	4,30	2,8	5,0	5,0	23,0	1
64435	5,00	3,2	5,5	7,0	24,0	1
64440	5,20	3,8	5,5	7,0	24,5	1
65044	6,40	4,2	6,5	8,0	25,0	1
65050	7,70	4,7	6,5	8,0	26,0	1

Dimensiones reales · Real dimensions

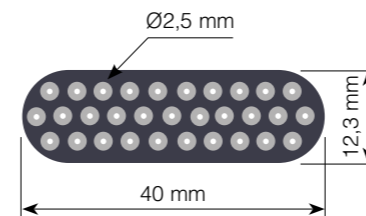

Pincel de silicona MIX

Pinceau de cuisine en silicone · Silikonpinsel
Silicone brush · Pincel de silicone

Ref	€	A (cm)	B (cm)	C (cm)	L (cm)	U.Venta
64431	7,20	3,8	4,0	1,0	24	12

EN

- For cooking or baking.
- Practical spatulas for scraping bowls, pots, dishes, etc.
- Brushes ideal for brushing oils or sauces, marinating meat or fish, greasing baking tins, and basting with oil, egg, syrup, etc.
- Doesn't absorb smells or tastes.



Pincel de silicona PRO

Pinceau en silicone · Silikonpinsel
Silicon brush · Pincel silicone

Ref	€	A (cm)	B (cm)	C (cm)	L (cm)	U.Venta
64418	10,80	4,0	4,0	1,4	22	1
64422	12,10	4,0	4,0	1,4	23	1



Pincel de silicona

Pinceau en silicone · Silikonpinsel
Silicon brush · Pincel de silicone

Ref	€	A (cm)	B (cm)	C (cm)	L (cm)	U.Venta
64441	6,70	5,8	3,4	1,7	23	1

Mango de Haya natural
Natural beech handle



Pincel UNITE

Pinceau · Silikonpinsel
Brush · Pincel

Ref	€	A (cm)	B (cm)	C (cm)	L (cm)	U.Venta
68196	4,10	5,5	3,1	1,1	24,5	1

ESPÁTULAS SILICONA

Colección



ES

- Fabricados en silicona de alta calidad libre de BPA.
- Núcleo reforzado para una mayor resistencia sin perder flexibilidad en los bordes. Diseñados en una sola pieza.
- Resistentes a altas temperaturas.
- Mango ergonómico suave al tacto y antideslizante.
- No rayan ni dañan artículos de cocina con antiadherente.
- Fáciles de limpiar. Aptas para el lavavajillas.

FR

- Fabriqué en silicone de haute qualité sans BPA.
- Noyau renforcé pour une résistance accrue sans perte de flexibilité des bords. Conception monobloc, sans coutures ni fissures.
- Résistant aux hautes températures.
- Poignée ergonomique, douce au toucher et antidérapante.
- Ne raye pas et n'endommage pas les ustensiles de cuisine antiadhésifs.
- Facile à nettoyer. Lavable au lave-vaisselle.

EN

- Made of high quality BPA free silicone.
- Reinforced core improves strength without losing flexibility around the edges. Designed in a single piece without seams or cracks.
- Can withstand high temperatures.
- Soft and non-slip ergonomic handle.
- Does not scratch cooking utensils with non-stick coating.
- Easy to clean. Dishwasher safe.



Utensilios GREY

Ustensiles en silicone · Silikonutensilien
Silicone utensils · Utensilios de silicone

	Ref	€	L (cm)	U.Venta
	64459	15,60	27,5	1
A	64463	5,50	27,5	1
B	64464	5,50	27,5	1
C	64465	5,60	27,5	1

Utensilios OCEAN

Ustensiles en silicone · Silikonutensilien
Silicone utensils · Utensilios de silicone

	Ref	€	L (cm)	U.Venta
	64452	16,70	27,5	1
	64453	5,80	27,5	1
	64454	5,80	27,5	1
	64455	5,80	27,5	1

Set 3 utensilios · Set 3 utensils
Cuchara · Spoon
Espátula · Spatula
Pincel · Brush

Fe
Iron



Espátula silicona

Spatule en silicone · Teigschaber
Silicone spatula · Espátula de silicone

	Ref	€	L (cm)	U.Venta
A	64444	5,90	28	1
B	64445	6,60	30	1
C	64446	6,70	31	1



Mango de polipropileno
Polypropylene handle

Espátula silicona

Spatule en silicone · Teigschaber
Silicone spatula · Espátula de silicone

	Ref	€	L (cm)	U.Venta
	67421	4,60	20	1
A	67427	6,80	26	1
	67433	14,90	32	1
B	67434	4,70	30	12
	67435	5,40	29	12

Espátula UNITE

Spatule · Backschauffel
Spatule · Espátula

	Ref	€	cm	L (cm)	U.Venta
	68195	4,30	5,6x8,5	26,5	1

Espátula silicona

Spatule en silicone · Teigschaber
Silicone spatula · Espátula de silicone

	Ref	€	L (cm)	U.Venta
	64450	5,60	25	6
A	64451	8,90	35	6
	64460	5,80	25	6
B	64461	9,70	35	6

New

Espátula para tarros

Spatule pour pots · Spatel für Einmachgläser
Jar spatula · Espátula para frascos

	Ref.	€	cm	L (cm)	U.Venta
A	64490	2,40	3,8x8,4	25	1
B	64491	4,00	4,8x10,8	35	1



- Fabricada en silicona y ABS de alta calidad, libre de BPA.
- Resistente a altas temperaturas.
- Cabezal flexible y maleable. No raya ni daña artículos de cocina con antiadherente.
- Diseñada especialmente para rebañar tarros a la perfección, aprovechando hasta lo último de mermeladas, mayonesas, salsas, etc.
- Higiénica. Fácil de limpiar. Apta para el lavavajillas.

- Fabriqué en silicone et ABS de haute qualité sans BPA.
- Résistant aux températures extrêmes.
- Tête flexibilité et malléabilité. Ne raye pas et n'endommage pas les ustensiles de cuisine antiadhésifs.
- Spécialement conçue pour racler les pots à la perfection, récupérant ainsi les dernières gouttes de confiture, mayonnaise, sauce, etc.
- Hygiénique. Faciles à nettoyer. Lavable au lave-vaisselle

- Made of high quality BPA free silicone and ABS.
- Resistant to extreme temperatures.
- Flexible and malleable head. Does not scratch cooking utensils with non-stick coating.
- It's specially designed for scraping all kinds of jars to perfection, so you can enjoy every last bit of your marmalade, mayonnaise or sauce, etc.
- Hygienic. Easy to clean. Dishwasher safe.

Set repostería (20 pcs.)

Exposant pâtisserie · Aufsteller Pastry
Pastry display · Expositor pasteleria

	Ref	€	L (cm)	Pieza	U.Venta
A	64424	78,30	-	Caja (20 pcs.) / Set (20 pcs.)	1
B	64426	4,00	23,0	Pincel / Brush	12
C	64427	4,00	23,0	Espátula / Spatula	12
D	64428	4,00	23,0	Lengua gato / Spatula	12
E	64429	4,00	23,0	Batidor / Whisk	12



New

Espátula profesional EXTRAplana

Spatula professionnelle · Profi-Spachtel
Professional spatula · Espátula profesional

	Ref	€	L (cm)	U.Venta
A	61373	5,50	30	1
B	61375	6,00	35	1
C	61374	7,30	40	1



- Espátula extraplana fabricada en nylon y fibra de vidrio especialmente diseñada para uso profesional.
- Sólida e indeformable. Resistente a altas temperaturas.
- No absorbe olores ni sabores.
- Apta para el lavavajillas.

- Spatule extra plate fabriquée en nylon et fibre de verre spécialement conçue pour un usage professionnel.
- Résistante aux hautes températures.
- Solide et indéformable. N'absorbe ni les odeurs ni les goûts.
- Apte pour le lave-vaisselle.

- Super thin, glass fibre nylon spatula, specially designed for professional use.
- High temperature resistant.
- Robust and non-deformable.
- Does not absorb smells or flavours.
- Dishwasher safe.

BATIDORES

Colección

Inox
18/10
Dishwasher



Inox



Batidor MINI

Mini fouet Inox · Mini-Schneebeesen
Mini whisk · Mini batedor Inóx

Ref	€	L (cm)	U.Venta
61615	5,40	15	12
61620	6,00	20	12



Batidor EXTRA 8

Fouet inox extra 8 · Schneebeesen, Extra 8
Extra 8 whisk · Batedor Extra 8

Ref	€	L (cm)	U.Venta
61625	8,50	25	6
61630	8,70	30	6
61635	9,10	35	6
61640	10,00	40	6
61645	10,80	45	6
61650	12,10	50	6
61655	12,80	55	6
61660	13,80	60	6



Batidor SUPER 12

Fouet inox super 12 · Schneebeesen, super 12
Super 12 whisk · Batedor Super 12

Ref	€	L (cm)	U.Venta
61626	7,80	25	6
61631	8,40	30	6
61636	9,10	35	6
61641	9,60	40	6
61646	9,90	45	6
61651	10,80	50	6

Si
Silicone
250
°C
BPA free

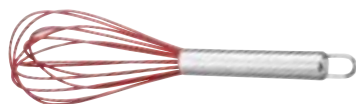

Batidor varilla silicona

Fouet en silicone · Ruhrbesen auf Silikon
Silicone wire whisk · Batedor vareta silicone

Ref	€	L (cm)	U.Venta
61621	8,00	20	12
61622	8,90	25	6
61623	9,90	30	12



Batidor gigante

Fouet à purée · Kesselbesen
Big whisk · Batedor gigante

Ref.	€	cm	Ø Varilla (mm)	U.Venta
60610	62,40	100	3	12
60612	80,00	129	3	12

Si
Silicone
LFGB
BPA free

A



Mango de Haya natural
Natural beech handle

B



Batidor varilla con espátula

Fouet avec grattoir · Schneebeesen mit Schaber
Whisk with spatula · Batedeira de varas com espátula

	Ref	€	L (cm)	U.Venta
A	68199	5,90	27,0	1
B	61627	6,20	32,0	12

- Indeformable. Varillas de acero inoxidable 18/10. Mango de fibra de vidrio resistente.
- Ideal para batir crema de leche, huevos, claras a puntode nieve, masas ligeras, cremas, etc.

- Indéformable. Tiges en acier inoxydable 18/10. Manche en fibre de verre durable.
- Idéal pour fouetter la crème, les œufs, les blancs d'œufs, les pâtes légères, les crèmes, etc.

- Non-deformable. 18/10 stainless steel rods. Durable fibreglass handle.
- Ideal for whipping cream, eggs, egg whites, egg whites, light doughs, creams, etc.

Si
Silicone
250
°C
BPA free



Batidor FIBREGLASS

Fouet · Schneebeesen
Whisk · Batedores

Ref	€	L (cm)	U.Venta
61624	11,80	25	6
61629	13,60	30	6
61634	15,40	35	6
61639	17,00	40	6
61644	20,40	45	6
61649	21,40	50	6



Batidor silicona FIBREGLASS

Fouet en silicone · Schneebeesen, Silikon
Silicone whisk · Batedores silicona

Ref	€	L (cm)	U.Venta
61524	10,80	25	6
61529	11,70	30	6
61534	13,60	35	6



Mango ergonómico
Ergonomic handle

Batidor FIBREGLASS

Fouet · Schneebeesen
Whisk · Batedores

Ref	€	L (cm)	U.Venta
61590	10,80	25	6
61591	11,70	30	6
61592	13,60	35	6

New

- Especial para preparar comidas que no contengan alérgenos.
- Spécialement pour la préparation de repas ne contenant pas d'allergènes.
- Specially for preparing meals that do not contain allergens.

Inox



Batidor manivela

Batteur-mélangeur à manivelle · Schneequirl
Egg beater · Batedor de manivela

Ref	€	U.Venta
62901	19,10	6



Batidor capuccino

Batteur pour cappuccino · Capuccino- Mixer
Capuccino mixer · Batedor capuccino

Ref	€	W	U.Venta
69041	26,70	2,7	1

JARRAS MEDIDORAS

Colección

Inox
18/10
Dishwasher



Incluye borde para facilitar el vertido
Includes rim for easy pouring



Vaso medidor BASIC

Verre doseur · Messbecher
Measuring cup · Copo medidor

	Ref	€	Ø (cm)	h (cm)	L	U.Venta
A	67075	7,40	8,5	16,0	0,5	1
B	67071	9,60	10,5	19,0	1,0	1

Marcajes de capacidad en ml, dl, onzas y cup
Capacity markings in ml, dl, ounces and cups

New



Set 3 jarras medidoras

Setn 3 pichets doseurs · Messbecher, 3 Er-Setr
Set of 3 measuring jugs · Conjunto 3 jarras medidas

	Ref	€	Ø (cm)	h (cm)	L	U.Venta
	67130	9,20	9,5	8,5	0,25	1
			11,0	10,0	0,50	
			13,0	11,5	1,00	

- Fabricadas en polipropileno de máxima calidad. 100% libres de BPA.
- Jarras graduadas en mililitros (ml), tazas (cup) y onzas (oz).
- Pico vertedor para facilitar el vertido y evitar derrames.
- Asa ergonómica con reposapulgares para facilitar el transporte, precisión y control en el vertido. Ambidiestro.
- Totalmente apilables, ocupando el mínimo espacio posible.

- Fabriqué en polypropylène de la plus grande qualité. 100% sans BPA.
- Pichets gradués en millilitres (ml), tasses (cup) et onces (oz).
- Bec verseur latéral pour mieux verser les liquides.
- Poignée ergonomique avec repose-pouces pour faciliter le transport et verser les liquides de façon plus précise et contrôlée. Ambidextre.
- Totalement empilables pour un gain de place maximum.

- Made of top quality polypropylene. 100% BPA free.
- Jugs graduated in millilitres (ml), cups (cup) and ounces (oz).
- Side spout for easy pouring.
- Ergonomic handle with thumb rest for easy carrying, precision and control when pouring. Ambidextrous.
- Fully stackable, taking up as little space as possible.



Marcajes de capacidad en el interior en onzas, ml, L y ccm (centímetro cúbico)
Capacity markings inside in ounces, mL, L and ccm (cubic centimetres)

Jarra medidora

Pot mesureur · Mass Behälter
Measuring jug · Jarra de medidas

	Ref	€	Ø (cm)	h (cm)	L	U.Venta
A	62745	14,40	9,0	10,5	0,5	1
B	62741	21,80	11,5	13,0	1,0	1
C	62742	25,80	15,0	17,0	2,0	1



Jarras medidoras

Pot mesureur · Mass Behälter
Measuring jugs · Jarras de medidas

	Ref	€	Ø (cm)	h (cm)	L	U.Venta
A	67210	3,50	9,0	13,8	0,5	1
B	67211	4,60	12,0	17,0	1,0	1
C	67212	7,90	15,0	20,8	2,0	1
D	67213	10,30	17,0	23,5	3,0	1
E	67214	16,00	20,0	27,5	5,0	1



Sistema de lectura rápida en ml, L y ccm (centímetro cúbico)
Easily readable markings in ml, l and ccm (cubic centimeter)



100% higiénica
100% hygienic



Resistente a choques térmicos
Highly resistant to thermal shock

Jarra medidora CRISTAL

Pot mesureur · Mass Behälter
Measuring jug · Jarra de medidas

Ref	€	L	U.Venta
67133	11,00	0,5	1



Sist. de lectura rápida en mililitros y cups
Easily readable markings in millilitres and cups

Jarra medidora SPIN

Pot mesureur · Mass Behälter
Measuring jug · Jarra de medidas

Ref	€	L	U.Venta
67165	11,80	0,5	1



Lectura rápida en litros, mililitros, onzas y cups
Readable markings in liters, millilitres, ounces and cups

Juego 3 jarras medidoras

Ensemble de 3 pot mesureur · 3-tlg. Satz Messbecher
3 piece measuring jugs · Jogo 3 jarras de medidas

Ref	€	L	U.Venta
67131	15,20	0,25-0,5-1,0	1



Set 5 jarras medidoras

Setn 5 pichets doseurs · Messbecher, 5 Er-Setr
Set of 5 measuring jugs · Conjunto 5 jarras medidas

Ref	€	cm	h (cm)	L	U.Venta
67215	39,90	15x9	15,3	0,5	1
		18x11	18,8	1,0	
		22x15	23,0	2,0	
		24x17	26,0	3,0	
		27x20	30,2	5,0	



Jarras apilables
Stackable jugs

Sistema de lectura rápida en mililitros (ml), litros (L) y ccm (centímetro cúbico)
Easily readable markings in millilitres (ml), Liters (l) and ccm (cubic centimeter)

EXACT & PRACTIC

Set de medición

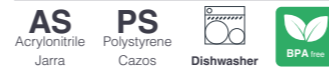

ES · Versátil. Ideal para ingredientes líquidos y secos.
· Jarra con sistema de lectura rápida en litros y cups. Permite comprobar el nivel del líquido mientras se está vertiendo el contenido.
· Cazos marcados en ml y bps para una rápida identificación.

FR · Polyvalent, idéal pour les ingrédients liquides et secs.
· Pichet avec système de lecture rapide en Litres et Cups. Permet de vérifier le niveau du liquide tout en versant le contenu.
· Cuillères marquées en ml et bps pour une identification rapide.

EN · Versatile: ideal for liquid and dry ingredients.
· Jug with easy to see quantities marked in litres and cups and easy to check liquid level while pouring contents.
· Ladles with ml and bps markings for easy reference.

Raspador · Scraper

6 cazos medidores

6 measuring cups
(7,5 ml, 15 ml, 60 ml,
85 ml, 125 ml, 250 ml)

Embudo · Funnel

Jarra medidora
Measuring jug
(1,0 L / 4 cups)

Compacto · Compact

Set de medición EXACT

Set de mesure · Messbecher-Set
Measuring set · Conjunto de medição

Ref	€	cm	h (cm)	L	U.Venta
62740	16,00	20x11	13,6	1,0	1

ES · Fabricadas en polipropileno de máxima calidad. 100% Libre de BPA.
· Pequeño vertedor lateral para facilitar el vertido.
· Asas ergonómicas para facilitar el transporte.
· 100% estable gracias a los pies antideslizantes.

FR · Fabriqués en polypropylène de la plus grande qualité. 100% sans BPA.
· Petit verseur latéral pour verser plus facilement.
· Poignées ergonomiques pour faciliter le transport.
· 100% stables grâce aux pieds antidérapants.

EN · Made of top quality polypropylene. 100% BPA free.
· Small side spout for easy pouring.
· Ergonomic handles for easy carrying.
· 100% with non-slip feet.



Jarra medidora · Measuring jug (0,5 L)

Jarra medidora · Measuring jug (1,0 L)

Escurreidor · Colander (2,0 L)

Bol mezclador · Mixing bowl (3,5 L)

Apilables · Stackable

Graduadas (mililitros / cups)
Graduated ml and cup marking

Set 4 boles PRACTIC

Ensemble de 4 récipients · Schüsseln, 4er-Set
Set of 4 bowls · Conjunto de 4 tigelas

Ref	€	Ø (cm)	h (cm)	L	U.Venta
62633	35,10	11,5	9,3	0,5	1
		14,5	10,6	1,0	
		18,5	13,0	2,0	
		22,0	15,0	3,5	

CALDEROS INOX

Colección



ES

· Ideal para mezclar los alimentos.
· Para uso profesional o doméstico.
· Fabricados en acero inoxidable 18/10, material muy resistente a la corrosión y ácidos alimentarios.
· Fácil limpieza: apto para el lavavajillas.

FR

· Idéal pour mélanger les aliments.
· Pour un usage professionnel ou domestique.
· Fabriqué en acier inoxydable 18/10, un matériau hautement résistant à la corrosion et aux acides.
· Nettoyage facile : passe au lave-vaisselle.

EN

· Ideal for mixing food.
· For professional or home use.
· Made of 18/10 stainless steel, a material highly resistant to corrosion and food acids.
· Easy cleaning: dishwasher safe.



Caldero semiesférico sin asas

Bassine hemispherique s/anses · Schneeschlagkessel ohne Griffe
Semi-spherical mixing bowl w/out/handles · Bacia semi-esférica sem asas

Ref.	€	Ø (cm)	h (cm)	L	U.Venta
50323S	36,50	22	11,0	2,70	1
50327S	42,60	26	13,0	4,00	1
50333S	57,20	32	17,0	9,50	1
50337S	64,90	36	18,0	12,00	1
50341S	108,90	40	21,0	14,50	1



Soporte
Bowl stand



Caldero semiesférico c/asas

Bassine hemispherique a/anses · Schneeschlagkessel mit Griffe
Semi-spherical mixing bowl w/handles · Bacia semi-esférica com asas

Ref.	€	Ø (cm)	h (cm)	L	U.Venta
50323	48,10	22	11,0	2,70	1
50327	54,70	26	13,0	4,00	1
50333	70,30	32	17,0	9,50	1
50337	75,60	36	18,0	12,00	1
50341	108,10	40	21,0	14,50	1



Soporte
Bowl stand



Caldero cónico

Bassine conique · Wanne
Mixing bowl · Bacia cónica

Ref	€	Ø (cm)	h (cm)	L	U.Venta
60013	12,40	13	6,1	0,55	1
60016	13,40	16	9,1	1,00	1
60020	18,40	20	11,7	2,12	1
60024	22,10	24	12,6	3,50	1
60028	27,60	28	13,4	5,25	1
60032	31,00	32	15,0	7,65	1
60036	42,90	36	16,0	11,00	1
60040	49,80	40	18,0	15,00	1



Cazo servir 'POCHON'

Pochon · Suppenkelle "Pochon" (Für server)
Pochon soup ladle for server · Caçarole servir "Pochon"

Ref	€	Ø (cm)	Mango (cm)	L (cm)	L	U.Venta
60520	59,70	20	22,50	42,5	2,00	1



Caldero cónico con asas

Bassine conique à anses · Wanne mit Griffe
Conical mixing bowl · Bacia cónica con asas

Ref.	€	Ø (cm)	h (cm)	L	U.Venta
50828	43,10	28	13,2	5,00	1
50832	47,80	32	14,5	7,00	1
50836	54,70	36	16,0	11,00	1
50840	60,80	40	18,0	15,00	1
50845	72,60	45	20,0	22,00	1
50850	87,10	50	21,0	30,00	1

garinox®



Cubo

Seau · Eimer
Pail · Balde

Ref	€	Ø (cm)	h (cm)	L	U.Venta
14114	9,30	16-12	15,5	1,40	1
14119	17,60	20-15	20,0	4,60	1
14124	21,90	24-17,2	20,5	5,60	1
14128	39,80	28-21	25,8	14,00	1

BOLES INOX

Colección



ES

- Set de 3 boles de acero inoxidable de máxima calidad.
- Acabado interior y exterior satinado.
- Versátiles: ideales para mezclar, batir, preparar masas y servir ensaladas o salsas.
- Perfectos para almacenar y conservar los alimentos.
- Compuesto por 3 boles perfectamente apilables entre sí.
- Base 100% antideslizante.
- Incluye 3 tapas herméticas fabricadas en polipropileno, libres de BPA.
- Marcaje de capacidad en el interior (L).
- Fácil limpieza. No aptos para el lavavajillas.

FR

- Ensemble de 3 bols en acier inoxydable de la plus grande qualité.
- Finition intérieure et extérieure satinée.
- Polyvalents : parfaits pour mélanger, battre, préparer des pâtes et servir des salades ou des sauces.
- Parfaits pour ranger et conserver les aliments.
- Composé de 3 bols parfaitement empilables entre eux.
- Fond 100% antidérapant.
- Inclut 3 couvercles hermétiques fabriqués en polypropylène, sans BPA.
- Marquage de capacité à l'intérieur (L).
- Nettoyage facile. Ne convient pas au lave-vaisselle.

EN

- Set of 3 top quality stainless steel bowls.
- Inner and outer satin finish.
- Versatile: ideal for mixing, whisking, making doughs and serving salads or sauces.
- Ideal for storing and preserving food.
- Comprises 3 perfectly stackable.
- 100% non-slip base.
- Includes 3 airtight lids made of BPA-free polypropylene.
- Capacity marks inside (L).
- Easy to clean. Not suitable for the dishwasher.



Set 3 boles INOX

Ensemble de 3 récipients · Schüsseln, 3er-Set
Set of 3 bowls · Conjunto de 3 tigelas

Ref	€	Ø (cm)	h (cm)	L	U.Venta
60050	39,20	16	10,0	1,5	1
		18	11,0	2,2	
		20	12,5	3,0	
60051	52,80	20	12,5	3,0	1
		22	13,5	3,8	
		24	14,0	4,0	

garinox®



Bol cónico

Bol conique · Schüssel, konisch
Conical mixing bowl · Bacia cónica

Ref	€	Ø (cm)	h (cm)	L	U.Venta
14016	3,80	16	6,5	0,90	12
14019	5,20	20	7,5	1,40	12
14025	9,40	24	9,0	2,50	1
14029	12,80	30	11,0	4,30	1
14033	17,80	34	13,5	7,50	1
14040	22,70	40	15,5	11,50	1
14046	32,20	45	17,5	17,40	1
14049	37,80	50	19,0	22,60	1

BOLES PP

Colección



ES

- Versátiles: ideales para mezclar, batir, preparar masas y servir ensaladas o salsas.
- Compuesto por 3 boles perfectamente apilables entre sí.
- Dispone de pico vertedor y pestaña de agarre antideslizante.
- Base 100% antideslizante.

FR

- Polyvalents : parfaits pour mélanger, battre, préparer des pâtes et servir des salades ou des sauces.
- Composé de 3 bols parfaitement empilables entre eux.
- Bec verseur et poignée antidérapante pour une meilleure prise en main.
- Fond 100% antidérapant.

EN

- Versatile: ideal for mixing, whisking, making doughs and serving salads or sauces.
- Comprises 3 perfectly stackable bowls.
- Featuring a pouring spout and non-slip grip. 100% non-slip base.

ES

- Versátiles: ideales para mezclar, batir, preparar masas, servir ensaladas o salsas.
- Compuesto por 6 boles perfectamente apilables entre sí.
- Incluye 6 tapas fabricadas en polipropileno, libres de BPA.
- Perfectos para almacenar y conservar los alimentos.

FR

- Polyvalents : parfaits pour mélanger, battre, préparer des pâtes et servir des salades ou des sauces.
- Composé de 6 bols parfaitement empilables entre eux.
- Comprend 6 couvercles en polypropylène, sans BPA.
- Parfait pour stocker et conserver les aliments.

EN

- Versatile: ideal for mixing, whisking, making doughs, serving salads or sauces.
- Comprises 6 perfectly stackable bowls.
- Includes 6 lids made of polypropylene, BPA free.
- Perfect for storing and preserving food.



Set 3 boles GREY

Ensemble de 3 récipients · Schüsseln, 3er-Set
Set of 3 bowls · Conjunto de 3 tigelas

Ref	€	Ø (cm)	h (cm)	L	U.Venta
60054	41,80	21,0	12,5	1,4	1
		26,0	14,2	2,8	
		31,2	14,8	4,7	

Cuerpos aptos para el lavavajillas
Dishwasher safe bodies



Set 6 boles MULTI

Ensemble de 6 récipients · Schüsseln, 6er-Set
Set of 6 bowls · Conjunto de 6 tigelas

Ref	€	Ø (cm)	h (cm)	L	U.Venta
60055	20,00	10,0	5,0	0,25	1
		14,0	6,8	0,80	
		17,0	8,0	1,15	
		20,3	9,5	2,00	
		24,3	11,0	3,35	
		28,3	12,5	5,25	

ETERN

Colección



New



Recipiente rectangular
Récipient rectangulaire · Rechteckbehälter
Rectangular container · Recipiente retangular

Ref	€	ml	cm	h (cm)	U.Venta
64600	11,10	800	18x13,5	7	1
64601	12,70	1200	20,5x15,5	7,5	1
64602	15,70	1800	23x17,5	8	1



Recipiente cuadrado
Récipient carré · Quadratischer Behälter
Square container · Recipiente quadrado

Ref	€	ml	cm	h (cm)	U.Venta
64603	9,80	650	14x14	7	1
64604	13,80	1500	18,5x18,5	8	1



Recipiente redondo
Récipient rond · Runder Behälter
Round container · Recipiente redondo

Ref	€	ml	cm	h (cm)	U.Venta
64605	10,00	700	16x16	6,5	1
64606	14,30	1500	20x20	7,5	1



Set 3 recipientes
Set de 3 récipients · Set mit 3 Behältern
Set with 3 containers · Conjunto com 3 recipientes

Ref	€	ml	cm	h (cm)	U.Venta
64607	38,70	800	18x13,5	7	1
		1200	20,5x15,5	7,5	
		1800	23x17,5	8	

ECOINOX

Colección



New



Recipiente rectangular
Récipient rectangulaire · Rechteckbehälter
Rectangular container · Recipiente retangular

Ref	€	ml	cm	h (cm)	U.Venta
64610	8,60	800	18x13,5	7	1
64611	10,60	1200	20,5x15,5	7,5	1
64612	13,20	1800	23x17,5	8	1



Recipiente cuadrado
Récipient carré · Quadratischer Behälter
Square container · Recipiente quadrado

Ref	€	ml	cm	h (cm)	U.Venta
64613	8,00	650	14x14	7	1
64614	11,40	1500	18,5x18,5	8	1



Recipiente redondo
Récipient rond · Runder Behälter
Round container · Recipiente redondo

Ref	€	ml	cm	h (cm)	U.Venta
64615	8,20	700	16x16	6,5	1
64616	12,30	1500	20x20	7,5	1



Set 3 recipientes
Set de 3 récipients · Set mit 3 Behältern
Set with 3 containers · Conjunto com 3 recipientes

Ref	€	ml	cm	h (cm)	U.Venta
64617	31,30	800	18x13,5	7	1
		1200	20,5x15,5	7,5	
		1800	23x17,5	8	

COLADORES

Colección

Inox 18/10
Dishwasher



Colador chino

Passoire "Chinois" · Spitzsieb mit Flachstiel
"Chinese" strainer · Passador chinês

Ref	€	Ø (cm)	U.Venta
60311	17,30	10	1
60313	17,80	12	1
60315	18,70	14	1
60317	20,40	16	1
60318	21,60	18	1
60320	23,40	20	1
60322	25,40	22	1
60324	26,70	24	1
60326	28,60	26	1



Colador chino mango varilla

Passoire "Chinois" manche fil · Spitzsieb mit Rundstiel
Wire handle "Chinese" strainer · Passador chinês cabo vareta

Ref	€	Ø (cm)	U.Venta
60316P	17,10	16	1
60318P	18,30	18	1
60320P	19,70	20	1
60322P	22,30	22	1
60324P	23,80	24	1



Colador chino mango varilla

Passoire "Chinois" manche fil · Spitzsieb mit Rundstiel
Wire handle "Chinese" strainer · Passador chinês cabo vareta

Ref	€	Ø (cm)	U.Venta
60316V	17,80	16	1
60319V	20,20	20	1



Nidos de alambre

Panier à nid · Nestbacklöffel
Bird's nest mould · Ninhos de arame

Ref	€	cm	L (cm)	U.Venta
62957	22,60	7-9	35	1
62959	26,40	9-11	37	1



Colador chino de malla

Passoire "Chinois" toile-metallique · Gazespitzsieb
Meshed "Chinese" strainer · Coador chinês de rede

Ref	€	Ø (cm)	U.Venta
60319	27,80	18	1
60321	34,50	20	1
60323	34,90	22	1
60325	38,30	24	1



Colador malla c/refuerzo

Chinois toile-metallique a croissillon · Gewebedurchschlag, konisch, verstärkt
Conical mesh strainer w/protection
Coador de rede c/reforço

Ref.	€	Ø (cm)	U.Venta
62621	52,80	20x22	1



Colador 1/2 esfera

Passe-bouillon · Passiersieb
Sieve · Coador 1/2

Ref	€	Ø (cm)	U.Venta
62680	5,20	8	1
62610	8,70	10	1
62612	11,20	12	1
62614	12,90	14	1
62616	15,20	16	1
62618	17,80	18	1
62620	23,10	20	1
62623	27,70	23	1



Colador

Passoire · Teigwaren-Einsatz
Colander · Coador

Ref.	€	Ø (cm)	h (cm)	U.Venta
50334	69,50	36	23,0	1
50338	84,20	40	26,0	1

Precio unitario · Prix unitaire · Unit price

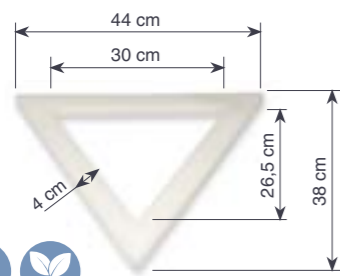

Triangulo

Triangle · Dreieck
Triangle · Triângulo

Ref.	€	h (cm)	mm	U.Venta
60402	55,30	2	400	1



Posibilidad de completar colador en 4 sectores solicitando 4 unidades

Possibility of completing strainer in 4 sectors requesting 4 units



Colador

Passoire à queue · Seiher mit Stiel
Strainer · Coador

Ref.	€	Ø (cm)	h (cm)	L	U.Venta
50320	55,70	20	12	3,5	1
50324	63,50	24	14	6,5	1
50328	74,40	28	15	9,3	1



Mano chino

Poussoir à chinois · Holz-Stößel
Chinese strainer pusher · Pilão p/passador chinês

Ref	€	L (cm)	U.Venta
60300	6,10	25	1

Colador DRAIN

Passe-bouillon · Passiersieb
Sieve · Coador

Ref	€	Ø (cm)	U.Venta
62697	5,20	7,5	6
62691	7,80	12,0	6
62698	12,40	18,0	1
62692	14,20	22,0	1



Mango de madera
Wooden handle

Colador doble malla

Passoir maillee · Passiersieb, stark
Mesh strainer · Coador rede dupla

Ref	€	Ø (cm)	L (cm)	U.Venta
61316	8,10	16	32,0	1
61318	9,40	18	34,0	1
61320	11,00	20	37,0	1
61323	28,00	23	56,0	1
61326	30,50	26	58,0	1
61330	54,30	30	78,5	1
61335	65,50	35	84,0	1

2 Ganchos
2 Hooks

1 Gancho
1 Hook

Alambre estañado · Fil étamé · Tinned wire



Colador cónico

Passoire conique · Passiersieb, konisch
Conical sieve · Coador cónico

Ref	€	Ø (cm)	U.Venta
62690	7,00	8	1
62611	9,20	10	1
62613	11,70	12	1
62615	14,50	14	1
62617	17,00	16	1
62619	19,50	18	1

ESCURRIDORES

Colección

Inox 18/10
Dishwasher



Malla metálica donde se depositan los alimentos
Metal mesh where food is deposited

Agujeros · Holes
1x1 cm



Recipiente donde se recoge el aceite sobrante
Container where excess oil is collected

Escurrefritos

Passoire a friture · Abtropfschüssel für Frittiertes
Fry colander · Escorre-fritos

Ref.	€	cm	h (cm)	U.Venta
50541	181,30	40x29	8,0	1
50551	213,90	50x39	8,0	1
50561	245,70	60x39	8,0	1

Ayuda a preparar rebozados perfectos
Helps prepare perfect batters



Harina tamizada, para su recuperación
Sifted flour, for its recovery

Harinero

Tamis à farine à glissière · Mehlbehälter
Flour bin mesh · Farinheiro

Ref.	€	cm	h (cm)	U.Venta
50438	162,70	37x26,5	18	1
50450	167,90	50x26,5	18	1

EMBUDOS

Colección

Inox 18/10
Dishwasher

Cuello ancho para verter con mayor rapidez en tarros/botellas sin riesgo de quemaduras
Wide neck for faster pouring into jars / bottles without risk of burns



Escurredera con base

Passoire sur pied · Abtropfschüssel mit Fussreif
Colander with stand · Escorredora com base

Ref.	€	Ø (cm)	h (cm)	L	U.Venta
50332	216,80	32	18	9,5	1
50336	263,50	36	19	12,0	1
50340	308,70	40	21	14,5	1



Escurredera cónica con base

Passoire conique sur pied · Abtropfschüssel
Conical colander with stand · Escorredor cónico com base

Ref	€	Ø (cm)	h (cm)	L	U.Venta
50829	70,70	28	17	13,2	1
50833	77,60	32	20	14,5	1
50837	88,40	36	23	16,0	1
50841	95,70	40	26	18,0	1
50846	109,70	45	29	20,0	1
50851	124,80	50	33	22,0	1



Ranura de
desgasificación
Filtro
Degassing groove
Filter



Embudo

Entonnoir · Trichter
Funnel · Funil

Ref	€	Ø (cm)	U.Venta
62512	15,70	12	1
62516	22,70	16	1
62521	29,40	20	1
62524	32,90	24	1



Embudo mermelada

Entonnoir à confiture · Mermeladentrichter
Funnel for jam · Funil de congestionamento

Ref	€	Ø (cm)	h (cm)	A (Øcm)	U.Venta
62517	10,00	13,5	6,5	6	1

Inox garinox®



Escurredera

Passoire · Abtropfschüssel
Colander · Escorredor

Ref	€	Ø (cm)	L	U.Venta
14122	18,40	22	3,0	1
14125	22,60	25	5,0	1
14130	32,70	30	8,0	1

Varillas extensibles
Extendable rods



Escurredor extensible para fregadera

Passoire extensible pour l'évier · Spülbank-Sieb, ausziehbar
Extendable sink strainer · Escorredor extensível para bancada

Ref	€	cm	Max (cm)	U.Venta
62987	24,00	34x24	55x24	1



Ranura de
desgasificación
Filtro extraíble
Degassing groove
Removable filter



Embudo con filtro

Entonnoir à filtre mobile · Trichter mit Sieb
Funnel with movable filter · Funil com filtro

Ref	€	Ø (cm)	A (Ø cm)	U.Venta
62531	12,80	10	1,2	1
62513	15,00	12	1,5	1
62515	17,20	14	1,5	1

Si 180 °C BPA free

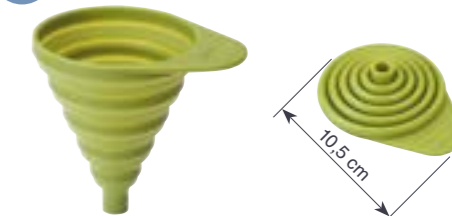

Embudo expandible

Entonnoir extensible · Trichter
Foldable funnel · Funil extensível

Ref	€	Ø (cm)	h (cm)	U.Venta
68085	5,90	8	10,5	1

HERVIDORES

Colección

Inox
18/10
Dishwasher



Hervidor extensible

Panier marguerite extensible · Kocher, ausdehnbar, Rostfrei
Extendable steamer · Grelha extensível

Ref	€	Ø (cm)	U.Venta
60349	6,70	24	12
60348	9,80	28	6



Cuece especias

Diffuseur épices · Kräterkochsieb
Spice cooker · Cozedor de especiarias

Ref	€	Ø (cm)	h (cm)	U.Venta
62958	12,30	4	15,4	1

New

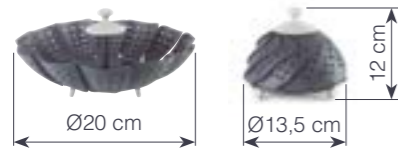

Hervidor extensible FLOR

Panier marguerite extensible · Kocher, ausdehnbar, Rostfrei
Extendable steamer · Grelha extensível

Ref	€	Ø (cm)	h (cm)	U.Venta
60288	8,00	13,5-26	12	1

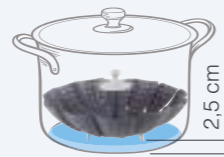

PP
polypropylene
BPA free

- Fabricado en polipropileno de máxima calidad, altamente resistente al calor, libre de BPA.
- Diseñado para cocinar los alimentos al vapor preservando todos sus nutrientes y vitaminas.
- Se adapta a diferentes tamaños de ollas gracias a sus hojas plegables.
- Almacenaje compacto; se pliega fácilmente y ocupa poco espacio.
- Tres pies antideslizantes de 2,5 cm de altura que no rayan la base de la olla. Pomo para una extracción segura.

- Fabriqué en polypropylène de la plus grande qualité, hautement résistant à la chaleur, sans BPA.
- Conçu pour faire cuire les aliments à la vapeur en préservant tous leurs nutriments et vitamines.
- S'adapte à différentes tailles de casseroles grâce à ses ailettes pliables.
- Rangement compact ; se plie facilement et prend peu de place.
- Trois pieds antidérapants de 2,5 cm de hauteur qui ne rayent pas le fond de la casserole. Poignée pour une extraction en toute sécurité.

- It's made of top quality BPA free polypropylene with high heat resistance.
- It's designed for steaming food and preserving all the vitamins and nutrients.
- It can fit different sizes of pots because of its collapsible leaves.
- Compact Storage: easy to fold and doesn't take up a lot of space.
- It has three 2.5 cm tall non-slip feet that won't scratch the bottom of the pot Knob for safe and secure removal.



Cacerola vapor

Panier vapeur · Dampfkoch-Aussatz o/Untertopf
Steam casserole · Caçarola a vapor

Ref	€	Ø (cm)	h (cm)	U.Venta
50428	58,90	28	11,0	1
50432	65,00	32	12,5	1



Hervidor pescado

Poissonniere avec grille · Fischkochkessel mit Einsatz
Fish kettle with grill · Peixeira

Ref.	€	cm	h (cm)	L	U.Venta
50440	102,80	40x19	11	10,05	1
50445	108,50	50x17	11	13,80	1
50460	141,70	60x19	11	20,80	1

HUEVO

Colección

Inox
18/10
Dishwasher



Asegura una separación limpia
Ensures clean separation



Separador de claras

Séparateur à oeuf · Eier-Separator
Eggs separator · Separador de ovos

Ref	€	U.Venta
61608	7,80	6



Soporte huevo OVUM

Support d'oeufs · Eierbecher
Egg stand · Suporte de ovo

Ref	€	Ø (cm)	h (cm)	U.Venta
68285	2,90	4,5	5	6

Si
Silicone
BPA free

Mango abatible
Folding handle

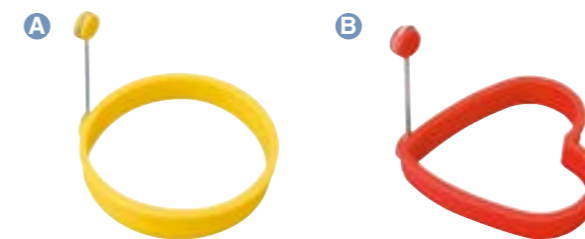

Molde huevo

Moule à oeufs · Eierform
Egg mould · Molde ovo

	Ref	€	cm	U.Venta
A	68080	6,10	Ø10x2	1
B	68082	6,10	10,5x10,5x2	1

Inox

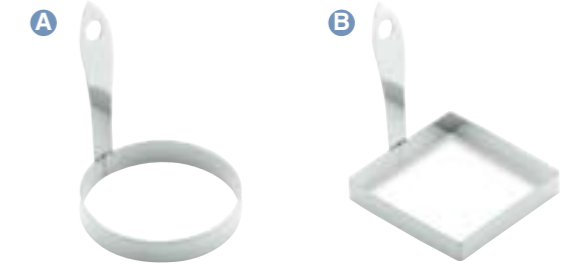

Molde huevo-sándwich

Moule à oeufs-sandwich · Eier-/Sandwichring
Mould for egg-sandwich · Molde ovo-Sandwich

	Ref	€	cm	U.Venta
A	68005	3,20	Ø8,5	12
B	68006	3,20	8,5x8,5	12



CORTADORES

Colección



ES

- Picadora de mecanismo manual que pica todo tipo de alimentos, como verduras, frutas, frutos secos, dátiles, jengibre, ajo, cebolla, hierbas, etc.
- Incluye tres potentes cuchillas ultrarresistentes fabricadas en acero inoxidable de máxima calidad.
- Práctico y muy fácil de usar: con tal solo tirar del asa las cuchillas se activan.
- Corta con precisión y homogeneamente.
- Asa ergonómica y base antideslizante 100% segura.
- Ocupa poco espacio ya que su asa-tirador se pliega sobre la tapa de la picadora.
- Pequeño, compacto y muy fácil de limpiar.

FR

- Hachoir à mécanisme manuel qui hache tout type d'aliments, comme les légumes, les fruits secs, les dattes, le gingembre, l'ail, les oignons, les herbes, etc.
- Il possède trois puissantes lames ultra-résistantes fabriquées en acier inoxydable de la plus grande qualité.
- Pratique et très facile à utiliser : il suffit de tirer de la poignée pour activer les lames.
- Coupe avec précision et de façon homogène.
- Poignée ergonomique et base antidérapante 100% sûre.
- Prend peu de place car sa poignée se replie sur le couvercle du hachoir.
- Petit, compact et très facile à nettoyer.

EN

- Manual chopper that chops all kinds of food, like vegetables, fruit, nuts, dates, ginger, garlic, onion, herbs, etc.
- It includes three ultra-strong blades made of top quality stainless steel.
- Practical and very easy to use: The blades are activated by simply pulling the handle.
- It cuts precisely and evenly.
- It has an ergonomic handle and a 100% safe non-slip base.
- It doesn't take up much space because the handle-pull folds onto the chopper lid.
- It's small, compact and very easy to clean.

3 cuchillas SpinPro ultrarresistentes de acero inoxidable
3 SpinPro blades ultra-resistant stainless steel



Cortador manual AFFILATO
Coupe manuel · Manuelle Schneider
Manual chopper · Cortador manual

Ref	€	Ø (cm)	h (cm)	L	U.Venta
60599	24,90	13	14	1,2	1



Velocidad I · Speed I
Corta y pica más grueso
Cut and chop more coarsely



Corta alimentos duros
It cuts thicker foods



Velocidad II · Speed II
Corta y pica más fino
Cut and chop more finely



Corta alimentos blandos
It cuts softer foods



Pica y corta alimentos en segundos
It chops and slices foods in seconds



3 cuchillas ultrarresistentes
3 ultra-strong blades

A



B



Cortador manual SHARP

Coupe manuel · Manuelle Schneider
Manual cutter · Cortador manual

	Ref	€	Ø (cm)	h (cm)	L	U.Venta
A	60299	21,10	12	11	0,5	1
B	60499	22,40	13	14	1,0	1

- 2 en 1: cortador de verduras y cortador para preparar patatas Hasselback.
- Ideal para cortar en rodajas cualquier tipo de alimento como patata, cebolla, tomate, pepino, zanahoria e incluso carne y pescado.
- Mango antideslizante para un agarre firme y pinchos que guían el cuchillo para un corte perfecto y uniforme.
- Fácil de limpiar. Apto para el lavavajillas.

- 2 en 1 coupe-légumes et coupe-pommes de terre pour préparer des pommes de terre Hasselback.
- Idéal pour couper en rondelles tout type d'aliments comme les pommes de terre, les tomates, les concombres, les carottes et même la viande et le poisson.
- Manche antidérapant pour une prise en main ferme et des pointes qui guident le couteau pour une découpe parfaite et uniforme.
- Facile à nettoyer. Convient au lave-vaisselle.

- 2 in 1: vegetable slicer and Hasselback potato slicer.
- Ideal for slicing any type of food such as potatoes, onions, tomatoes, cucumbers, carrots and even meat and fish.
- Non-slip handle for a firm grip and skewers that guide the knife for perfect and even slicing.
- Easy to clean. Suitable for the dishwasher.



Cortador de patatas HASSELBACK

Coupe-pommes de terre Hasselback · Hasselback-Kartoffelschneider
Hasselback potato slicer · Cortador de batatas Hasselback

Ref	€	cm	h (cm)	U.Venta
68180	9,60	18x10	2,1	1



3 cuchillas (6 - 9 - Rodajas 6 mm)
2 empujadores
Peines de limpieza
3 blades (6 - 9 - Slice 6 mm)
2 pushers
Cleaning combs



Cortador de verdura y chips

Coupe de légumes · Gemüseschneidemaschine
Chips and vegetable cutter · Cortador de verdura e chips

Ref	€	cm	h (cm)	U.Venta
60344	45,30	11,5x21,5	11	1

- Funcionamiento sencillo; insertar el tallo en el agujero que mejor se adapte y deslizar la rama en dirección contraria.
- Contiene agujeros de distinto tamaño:
 - a.- Los pequeños para deshojar hierbas aromáticas como el romero, orégano, tomillo, estragón, etc.
 - b.- Los más grandes para separar el tallo más duro que tienen algunas verduras de la hoja como las acelgas, espinacas, col rizada, etc.
- Gracias a la parte más aguda, se pueden cortar las hojas con el mismo utensilio.

- Easy to use. Put the stalk into the hole where it fits best and pull the herb in the opposite direction.
- There are different sized holes:
 - a.- The small holes are for stripping leaves from aromatic herbs like rosemary, oregano, thyme, tarragon, etc.
 - b.- The bigger holes are for separating harder stalks found in some leafy vegetables like chards, spinach, kale, etc.
- With the sharp end you can use the same utensil to cut leaves.



Parte aguda para cortar
Sharp part for cutting

Separador de hojas
Separating leaves

2 in 1

Deshojador de hierbas aromáticas

Effeuilleuse à herbes aromatiques · Entblätterer für gewürzkräuter
Aromatic herb stripper · Desfolhador de ervas aromáticas

Ref	€	cm	U.Venta
61359	6,50	16,5x7,5x2	1

PICADORES

Colección



ES

- Picadora de mecanismo manual que pica todo tipo de alimentos, como verduras, frutas, jengibre, ajo, cebolla, frutos secos y hierbas.
- Cuchilla de acero inoxidable de máxima calidad.
- Recipiente transparente para visualizar el proceso. Libre de BPA.
- Muy fácil y cómodo de usar gracias a su sistema manual PressTurn.
- Tapa de polietileno antideslizante para facilitar la tarea y evitar desplazamientos.
- Fácil de desmontar y limpiar.

FR

- Hachoir à mécanisme manuel qui hache tout type d'aliments, comme les légumes, les fruits, le gingembre, l'ail, l'oignon, les fruits secs et les herbes.
- Lame en acier inoxydable de la plus grande qualité.
- Récipient transparent. Sans BPA.
- Très facile et pratique à utiliser grâce à son système manuel PressTurn.
- Couvercle antidérapant pour faciliter la tâche et éviter les glissements.
- Facile à démonter et à nettoyer.

EN

- Hand-operated food processor for chopping all types of food, such as vegetables, fruit, ginger, garlic, onion, nuts and herbs.
- Top quality stainless steel blade.
- Transparent jar for easy viewing. BPA free.
- Very simple, easy to use manual PressTurn.
- Non-slip lid to simplify the process and avoid slipping.
- Easy to dismantle and clean.



Diseño compacto
Compact design



Picadora manual PRESS

Hachoir manuel · Handschneider
Manual food chopper · Picador manual

Ref	€	Ø (cm)	h (cm)	U.Venta
62819	35,70	9,4	22,7	1



Picadora manual

Hachoir manuel · Handschneider
Manual food chopper · Picador manual

Ref	€	Ø (cm)	h (cm)	U.Venta
62980	31,90	9,5	22	6



Picaperejil

Hachoir à manivelle pour fines herbes · Kräutermühle, fein
St. steel fine herbs mincer · Pica-salsa

Ref	€	cm	U.Venta
60334	22,30	13,5x20x7,5	1

Inox



Picadora de carne manual

Hachoir avec manivelle · Fleischwolf mit handkurbe
Meat mincer · Picadora de carne manual

Ref	€	cm	U.Venta
60329	123,80	17x12x19	1

Multifuncional: pica, bate y centrifuga
Mecanismo de manivela
que requiere muy poca fuerza
Multifunctional: chop, beat and spin
Crank mechanism requiring very little force

Sistema TurnCut
Accionamiento manual de la manivela
100% estable. Sujeción mediante ventosa
TurnCut System
Manual crank operation
100% stable. Suction cup fastening

Inox ABS plastic



Picadora

Mincer · Fleischwolf
Hachoir · Picadora

Ref	€	cm	U.Venta
60340	34,70	18x22	1

Mini picadora-batidora manual

Mini hachoir-fouet manuel · Minizerhacker-Schneebeesen
Manual mini chopper-whisk · Mini picadora-batedeira manual

Ref	€	Ø (cm)	L	U.Venta
60361	18,10	Ø17x18	1,00	1

TOMATE

Triturador

ES

- Saca el máximo jugo a los alimentos, libre de pieles y semillas.
- Filtro de acero inoxidable de gran calidad y contenedor de polipropileno, libre de BPA.
- Superversátil: prepara salsas de tomate, purés de patata, mermeladas, conservas, etc. con un único aparato.
- Entrada de alimentación de gran capacidad.
- Dispone de un orificio de salida para desechos.
- 100% estable: sistema de sujeción mediante ventosa.
- Incluye empujador para facilitar y agilizar el procesado.
- Totalmente desmontable y fácil de limpiar.

FR

- Recueillir au maximum le jus des aliments, sans peaux ni pépins.
- Filtre en acier inoxydable de grande qualité et conteneur en polypropylène, sans BPA.
- Très polyvalent: préparer des sauces tomate, des purées, des confitures, des conserves, etc. avec un seul appareil.
- Entrée d'aliments de grande capacité.
- Dispose d'un orifice de sortie pour déchets.
- 100% stable: système de fixation via des ventouses.
- Inclut un poussoir pour faciliter et accélérer le processus.
- Entièrement démontable et facile à nettoyer.

EN

- Designed to get the most juice out of food with no peels or seeds.
- It has a high quality stainless steel filter and a BPA free polypropylene container.
- Extremely Versatile: make tomato sauces, potato purée, marmalade, preserves, etc. with a single appliance.
- High capacity food input
- It has an outlet for waste.
- 100% Stable: it has an attachment system that uses suction cups.
- A pusher is included to make processing food faster and easier.
- It can be completely disassembled and it's very easy to clean.



Incluye empujador
Salida para desechos
Salida de jugo, libre de pieles y semillas
Includes pusher
Outlet for waste
Juice outlet with no peels or seeds

Triturador manual de tomate

Presse-tomates manuel · Handpresse für Tomaten
manual tomato chopper · Triturador manual de tomate

Ref	€	U.Venta
60394	47,20	1



OSO Garras

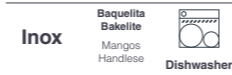

ES

- Fabricadas en acero inoxidable de máxima calidad.
- Diseñadas para desmenuzar y manipular carnes hechas al horno o barbacoa, como pollo, carne de vacuno, pavo, aves, jamón, etc.
- Puntas afiladas para manipular la carne sin esfuerzo. Forma curvada para un mejor agarre y mayor comodidad.
- Mangos ergonómicos de baquelita resistentes al calor, 100% seguros.
- Multifuncional: desmenuza y traslada la carne, facilita la sujeción para cortes con cuchillo, remueve las ensaladas o pastas, etc.
- Fácil de limpiar. Aptas para el lavavajillas.

FR

- Fabriquées en acier inoxydable de la plus grande qualité.
- Conçues pour émincer et manipuler des viandes cuites au four ou au barbecue comme du poulet, du boeuf, de la dinde, de la volaille, du jambon, etc.
- Pointes aiguisées pour manipuler la viande sans effort. Forme courbée pour une meilleure prise en main et un plus grand confort.
- Poignées ergonomiques en bakélite résistantes à la chaleur, 100% sûres.
- Multifonctions : émincer et transférer la viande, faciliter la prise en main pour une découpe au couteau, remuer les salades ou les pâtes, etc.
- Facile à nettoyer. Aptes pour le lave-vaisselle.

EN

- Made of top quality stainless steel.
- Designed for shredding and handling baked or barbecued meats, such as chicken, beef, turkey, poultry, ham, etc.
- Sharp tips for easy handling of meats. Curved shape for better grip and comfort.
- Ergonomic heat-resistant Bakelite handles, 100% safe.
- Multifunctional: perfect for shredding, turning and holding meat in place while cutting it with a knife, ideal for mixing salads or pasta, etc.
- Easy to clean. Dishwasher safe.



Manipula carnes
Desmenuza carnes
Manipulate meat
Crumble meats

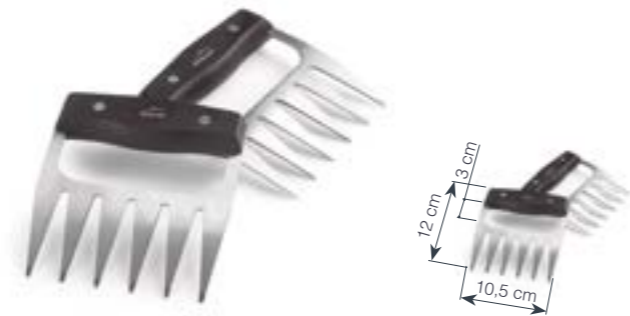

Garras de oso para carne

Griffes à viande · Fleisch Bärenkrallen
Bear claws for meat · Garras de urso para carne

Ref	€	cm	U.Venta
38015	12,70	10,5x12	1

PASAPURÉS Colección



2 Discs



2 Discs



3 Discs



2 Discs

Pasapurés

Presse-Puree · Passiergerät
Potato mashing machine · Passa-puré professional

	Ref.	€	Ø (cm)	L	Ø Disco (cm)	U.Venta
A	60026	124,20	26	5,0	16,5	1
B	60031	129,80	32	8,0	16,5	1
B	60030	82,40	30	3,5	16,5	1
C	60048	55,10	18	0,7	10,5	1
C	60027	72,40	24	1,5	13,5	1
D	60021	55,90	20	1,5	11,5	1

MORTEROS Colección



ES

- Fabricados en granito de calidad premium.
- Interior no poroso, permite extraer los aceites naturales de las hierbas y especias.
- El diseño de la mano permite maniobrar con facilidad y con poco esfuerzo.
- Pesado y bien balanceado.

FR

- Composé de granit de qualité supérieure.
- Intérieur non poreux permettant d'extraire les huiles essentielles des herbes et épices.
- La conception de la main facilite les manœuvres et réduit lrs efforts.
- Lourd et bien équilibré.

EN

- Manufactured from premium quality granite.
- Interior not porous allowing extracting natural oils from herbs and spices.
- The design of the hand allows easy manoeuvres with little effort.
- Heavy and well balanced.



Mortero con mano de granito

Mortier et pilon en granit · Mörser und Stößel aus Granit
Granite mortar and pestles · Argamassa e pilão do granito

	Ref	€	Ø (cm)	h (cm)	ml	U.Venta
A	60512	25,80	12,0	8,0	250	1
B	60514	30,10	14,0	10,0	375	1
B	60516	31,30	16,0	12,0	600	1
C	60517	25,00	10,5	7,5	225	1
D	60518	25,40	12,0	12,0	365	1



Mano mortero

Poussoir à mortier · Stößel
Pestle · Pilão p/almofariz

Ref.	€	Ø (cm)	U.Venta
60401	39,20	Ø4,8x25	1



Mortero

Mortier · Mörser
Mortar · Almofariz

Ref.	€	Ø (cm)	U.Venta
60403	160,70	18	1

PRENSADORES

Colección

Inox
18/10
Dishwasher



Prensador de patatas
Presse-purée · Kartoffelpresse
Potato masher · Prensa-batatas

Ref	€	cm	h (cm)	U.Venta	
A 62896	17,90	ø11,6	45,5	1	New
B 62892	19,40	10,5x8,5	24,0	1	
C 62897	8,50	11x7,5	17,5	1	New

- Fabricado en acero inoxidable 18/10 de alta calidad y gran resistencia.
- Tritura sin esfuerzo cualquier alimento cocinado previamente o de textura blanda.
- Ideal para preparar puré de patata, tomate, calabaza, plátano, etc.
- Superficie de prensado diseñado para conseguir un acabado homogéneo.
- No transmite olores ni sabores a los alimentos.

- Fabriqué en acier inoxydable 18/10 de grande qualité et d'une résistance maximale.
- Triture sans effort tout aliment préalablement cuit ou à texture molle.
- Idéal pour préparer de la purée de pomme de terre, de courge, de banane, etc.
- Surface de pressage conçue pour obtenir un résultat homogène.
- Ne transmet ni odeurs ni goûts aux aliments.

- Made of top quality, high resistance 18/10 stainless steel.
- Easily mashes any pre-cooked or soft-textured foods.
- Ideal for mashing potatoes, tomatoes, pumpkin, bananas, etc.
- Mashing surface designed for even mashing, giving perfect results.
- Does not transmit odours or flavours.



Prensa patatas

Presse-pomme de terre · Kartoffelpresse
Potato press · Esmaga-batatas

Ref	€	cm	U.Venta
62902	34,90	9x28x11	1



Molde empanadillas

Moule à chaussons · Pastetenformen
Dumpling mould · Forma para salgados

Ref	€	Ø (cm)	U.Venta
68101	20,90	10	1
68102	22,90	12	1

Pica y lamina
Chop and slice

Accesorio para eliminar los restos
Accessory for eliminating the remains

Zamak
Zinc Alloy



Prensa ajos y laminador

Presse ail coupe · Knoblauchpresse, Schneider
Garlic press and slicer · Esmaga-alhos y laminador

Ref	€	L (cm)	U.Venta
60387	26,40	20	1



Resultados perfectos. Empanadillas iguales y perfectamente selladas
Perfect results. Equal and perfectly sealed dumplings

ABLANDACARNES

Colección

Inox
18/10
Dishwasher

- Sólida, robusta y especialmente pesada (734 g) para ablandar, aplanar y ensanchar fácilmente todo tipo de carnes.
- Gran superficie de aplastado con un espesor de 12 mm.
- Mango robusto ergonómico para un fácil manejo con práctica presilla para colgar.
- Higiénica e inodora, no absorbe los olores de los alimentos.

- Solide, extrêmement robuste et spécialement conçu (734 g) pour attendrir, aplatir et élargir facilement tout type de viande.
- Grande surface de travail avec une épaisseur de 12 mm.
- Manche robuste et ergonomique pour une prise en main facile et un crochet pratique pour le suspendre.
- Hygiénique et inodore, il n'absorbe pas les odeurs des aliments.

- Solid, extremely robust and specially designed (734 g) to easily tenderise, flatten and widen all types of meat.
- Large 12 mm thick flattening surface.
- Sturdy, ergonomic handle for firm grip and easy handling.
- Features a practical hanging eye.
- Hygienic and odourless: does not absorb odours or flavours.

New



Maza ablandacarne

Attendrisseur de viande · Fleischhammer
Meat mallet · Maço para amciar carne

Ref	€	cm	h (cm)	U.Venta
61251	25,10	27x8	5,0	1

Liso para reducir el grosor de la carne.
Rugoso para ablandar y para que penetre mejor los adobos
Smooth side, to reduce the thickness of the meat.
Rough side for softening and better marinade penetration



Mango ergonómico y antideslizante
Ergonomic non-slip handle

Martillo ablandacarne

Marteau attendrisseur de viande · Fleischklopf Hammer
Meat hammer tenderizer · Martelo ablandador de carne

Ref	€	cm	U.Venta
60431	16,90	7x24	1

- 48 cuchillas extremadamente afiladas fabricadas en acero inoxidable.
- Las cuchillas crean pequeños canales térmicos dentro de la carne, permitiendo que el calor penetre y se distribuya uniformemente.
- Ideal para preparar todo tipo de carnes para que queden más jugosas, sabrosas y blandas.
- Las cuchillas se retraen automáticamente al dejar de presionar.
- Mango ergonómico antideslizante, garantiza un agarre seguro y eficiente.
- Diseño seguro con cubierta protectora.

- 48 lames extrêmement aiguës fabriquées en acier inoxydable.
- Les lames créent de petits canaux thermiques dans la viande, permettant ainsi à la chaleur de pénétrer et de se répandre uniformément.
- Idéal pour préparer tout type de viandes afin qu'elles soient juteuses, savoureuses et tendres.
- Les lames se rétractent automatiquement dès que l'on cesse d'appuyer sur l'appareil.
- Manche ergonomique antidérapant qui garantit une prise en main sûre et efficace.
- Conception sûre avec couvercle de protection.

- 48 extremely sharp high quality stainless steel blades.
- The blades create small heat channels in the meat, ensuring even heat absorption and distribution.
- Ideal for cooking all kinds of meat for more succulent, tender and juicy dishes.
- The blades retract automatically when you stop pressing.
- Ergonomic, non-slip handle for a comfortable, safe grip.
- Safe design with protective cover.

New



48
Blades

Maza ablandacarne BLACK

Attendrisseur de viande · Fleischhammer
Meat mallet · Maço para amciar carne

Ref	€	Cuchillas (cm)	U.Venta
61250	8,90	6x3	1



16
Blades

Ablandacarne INOX

Attendrisseur à viande en Inox · Fleischklopf Hammer
St. steel meat tenderizer · Ablandacarne Inóx

Ref	€	cm	U.Venta
60432	37,70	12x2	1

PRENSA HAMBURGUESAS

Colección



Prensa hamburguesas
 Presse à hamburguers · Hanburger-Formen
 Hamburg presser · Moldes para hamburgüeres

Ref	€	Ø (cm)	U.Venta
60258	14,60	11,5x7,5	1
R60258A	1,50	11	1

60 separadores separators



- Molde de aleación de aluminio fundido de gran calidad con recubrimiento antiadherente.
- Pomo de madera desmontable y ergonómico, permite una distribución uniforme de la presión para crear hamburguesas caseras de carne, vegetarianas o veganas.
- Perfectas en proporción y consistencia.
- Superficie interior acanalada, proporciona un aspecto profesional.
- Incluye 60 unidades de papel antiadherente de Ø11 cm.
- Fácil de limpiar.

- Moule en alliage de fonte d'aluminium de grande qualité avec revêtement anti-adhésif.
- Pommeau en bois démontable et ergonomique, permet une distribution uniforme de la pression pour créer des steaks à hamburger maison de viande, végétariens ou végans.
- Proportion et consistance parfaites.
- Surface interne cannelée, qui confère un aspect professionnel.
- Comprend 60 unités de papier antiadhésif Ø11 cm.
- Facile à nettoyer.

- High quality cast aluminum alloy mold with non-stick coating.
- Removable ergonomic wooden handle, facilitates uniform distribution of pressure to make homemade beef, vegetarian or vegan burgers.
- Perfect proportions and consistency.
- Ribbed inner surface, provides a professional appearance.
- Includes 60 units of Ø11 cm non-stick paper.
- Easy to clean.

New

Separadores · Separators



- Fabricado en aluminio fundido anodizado y acero inoxidable 18/10.
- Firme, robusto y resistente.
- Diseñado para un uso profesional intensivo y continuado; ideal para carnicerías, hamburgueserías, restaurantes, etc.
- Diámetro de la hamburguesa: Ø100 mm (60226)/130 mm (60227). Forma uniforme.
- Funcionamiento manual: mecanismo de palanca.
- Mecanismo de extracción rápida: extrae la hamburguesa con total facilidad.
- Depósito para almacenar las hojas separadoras y tenerlas a mano mientras se elaboran las hamburguesas.
- Pies de goma antideslizantes: máxima estabilidad durante el uso.
- Incluye 500 unidades de papel antiadherente perforado de Ø10/13 cm (evita que la carne se pegue a la hora de retirar el papel).

- Fabriqué en fonte d'aluminium anodisé et en acier inoxydable 18/10.
- Stable, robuste et résistante.
- Conçue pour un usage professionnel intensif et continu; idéale pour les boucheries, les établissements de hamburgers, les restaurants, etc.
- Diamètre du steak haché: Ø100 mm (60226)/130 mm (60227). Forme uniforme.
- Fonctionnement manuel: mécanisme à levier.
- Mécanisme d'extraction rapide: extrait le steak haché avec une grande facilité.
- Compartiment pour ranger les feuilles de séparation et les avoir à portée de main pendant l'élaboration des steaks hachés.
- Pieds en caoutchouc antidérapant: stabilité maximale pendant l'utilisation.
- Inclut 500 unités de papier antiadhésif perforé de Ø10/13 cm (évite que la viande colle lors du retrait du papier).

- Made of anodized cast aluminium and 18/10 stainless steel.
- Rigid, robust and strong.
- Designed for intensive continuous professional use, and perfect for butcher shops, hamburger and other restaurants, etc.
- Patty diameter Ø100 mm (60226)/130 mm (60227) Consistent shape.
- Manual Operation: lever mechanism.
- Quick Release Mechanism: Patties can be removed very easily.
- Holder for storing separator sheets and keeping them handy when you're making patties.
- Non-slip Rubber Feet: Maximum stability during use.
- Includes 500 Ø10/13 cm sheets of non-stick paper with holes to keep the meat from sticking when the paper is removed.



Prensa hamburguesas MULTI
 Presse à hamburguers · Hanburger-Formen
 Hamburg presser · Moldes para hamburgüeres

Ref	€	Ø (cm)	U.Venta
60259	7,30	12,5x6	1
R60259A	1,40	10	1

60 separadores separators



Paso a paso... / Pas à pas... / Step by step...

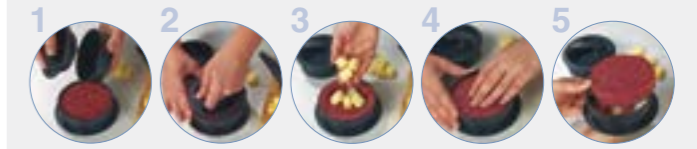

- Fabricado en plástico ABS de alta calidad y durabilidad. Libre de BPA.
- Compuesto por 6 piezas totalmente desmontables.
- Versátil: ideal para preparar y rellenar todo tipo de hamburguesas.
- Base extraíble acanalada para facilitar la extracción de la hamburguesa.
- Compacto: se guarda en una sola pieza.
- Práctico y muy fácil de usar.
- Medidas (mm): hamburguesa grande Ø10x3 cm / mini Ø6,5x2 cm.
- Incluye 60 unidades de papel antiadherente de Ø10 cm.
- Fácil de limpiar. Apto para el lavavajillas.

- Fabriqué en plastique ABS d'une grande qualité et durabilité. Sans BPA.
- Composée de 6 pièces entièrement démontables.
- Polyvalente: Idéale pour préparer et garnir tout type de hamburgers.
- Base extractible cannelée pour faciliter l'extraction du steak.
- Compacte: Se range en une seule pièce.
- Pratique et très facile à utiliser.
- Dimensions (mm): Grand steak Ø10x3 cm/Mini steak mini Ø6,5x2 cm.
- Comprend 60 unités de papier antiadhésif Ø10 cm.
- Facile à nettoyer. Apte pour le lave-vaisselle.

- Made of high quality, durable ABS plastic. BPA free.
- Comprised of 6 fully detachable parts.
- Fully versatile: perfect for making and filling all types of burgers.
- Detachable grooved base to simplify burger extraction.
- Compact: single piece storage.
- Very practical and easy to use
- Dimensions (in mm): Large burger Ø10x3 cm/Mini burger Ø6,5x2 cm.
- Includes 60 units of Ø10 cm non-stick paper.
- Easy to clean. Dishwasher safe.

EXPRIMIDORES MANUALES

Colección

Inox 18/10  Dishwasher

Disfruta del zumo recién exprimido
Enjoy freshly squeezed juice



ES

- Ideales para limas, limones, naranjas e incluso pomelos.
- Extraen el jugo sin cascaras, pulpa y semillas.

FR

- Idéales pour les citrons verts, les citrons jaunes, les oranges et même les pamplemousses.
- Extrait le jus sans peau, pilpe ou graines.

EN

- Ideals for limes, lemons, oranges and even grapefruit.
- Extracts the juice without peel, pulp and seeds.

Medidor (ml/cup)
Measure (ml/cup)

PMMA plastic Jarra/Jug
PP polypropylene Cazo/Cone
BPA free

AS plastic Jarra/Jug
ABS plastic Cazo/Cone
BPA free



Exprimidor manual
Presse citron manuel · Manuelle zitronenpresse
Manual reamer · Espremedor manual

Ref	€	cm	h (cm)	L	U.Venta
A 68181	6,40	10x9,5	8,5	0,07	1
B 67134	7,30	18,5 x11	15,0	0,50	1

Inox



Exprimidor manual INOX

Presse citron manuel · Manuelle zitronenpresse
Manual reamer · Espremedor manual

Ref	€	Ø (cm)	L	U.Venta
62952	17,60	10	0,15	6
62912	20,60	12	0,20	6

Exprimidor de zumo

Presse-fruits manuel · Manuelle fruchtresse
Manual squeezer · Espremedor de sumos

Ref	€	cm	h (cm)	U.Venta	
A 63913	58,30	21x18	21	1	Bajo · Low
B 63914	53,70	15x19	39	1	Alto · High

B Inox 18/10 **New**

A AL Aluminium **3 in 1**

Exprimidor manual
Presse citron manuel · Manuelle zitronenpresse
Manual reamer · Espremedor manual

Ref	€	L (cm)	U.Venta
A 63915	11,10	22	1
B 68182	25,80	22	1 New

- Excelente resistencia a la corrosión; no se oxida o reacciona a los jugos de los cítricos.
- Ideales para exprimir limas, limones y naranjas.
- Superficie acanalada para extraer el máximo jugo.
- Mango ergonómico para un fácil exprimido y un menor esfuerzo.
- Apto para el lavavajillas.

- Excellente résistance à la corrosion ; ne rouille pas et n'est pas réactif au jus des agrumes.
- Idéales pour presser des limes, citrons et des oranges.
- Surface cannelée pour extraire au maximum le jus.
- Manche ergonomique pour un pressage simple et un effort minimum.
- Compatible avec le lave-vaisselle.

- It has excellent corrosion resistance and does not rust or react to citrus juice.
- It's perfect for squeezing limes, lemons and oranges.
- Grooved surface for maximum juice extraction.
- It has an ergonomic handle to make squeezing juice easy and almost effortless.
- Dishwasher safe.



Exprimidor manual FLOR

Presse citron manuel · Manuelle zitronenpresse
Manual reamer · Espremedor manual

Ref	€	Ø (cm)	h (cm)	U.Venta
63912	12,70	4,5	16	1



Exprimidor limón

Presse-citron · Zitruspresse
Lemon squeezer · Espremedor de limão

Ref	€	U.Venta
62946	11,70	1

ALIMENTOS

Contenedor

PE ASA 
Polyethylene Acrylic

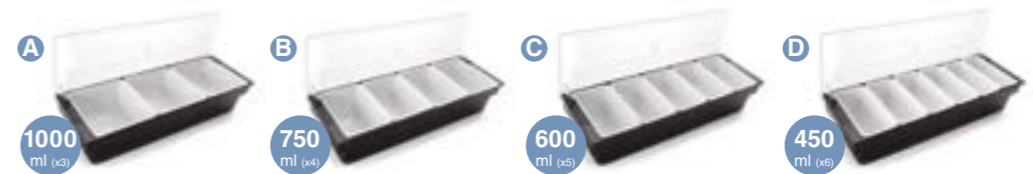

Contenedor alimentos con tapa

Boîte à condiments avec couvercle · Gewürzkasten mit Deckel
Condiments holder with lid · Caixa condimentos com tampa

Ref	€	cm	Cavidades	Unidad (ml)	U.Venta
A 61133	27,70	50x16x9	3	1000	1
B 61134	27,70	50x16x9	4	750	1
C 61135	27,70	50x16x9	5	600	1
D 61136	27,70	50x16x9	6	450	1



Ideal para especias y condimentos
Ideal for spices and condiments

LAMINADORA PASTA

Máquina



Disfruta cocinando tu propia pasta fresca
Enjoy cooking your own fresh pasta

ES

- Rodillos de acero inoxidable, permiten conseguir hasta 9 grosores de pasta.
- Posibilidad del accesorio para Rabiolis.

FR

- Rouleaux en acier inoxydable, qui permettent d'obtenir jusqu'à 9 épaisseurs de pâtes.
- Possibilité d'ajouter l'accessoire pour raviolis.

EN

- Edelstahlwalzen mit 9 verschiedenen Stärken für Ihre Nudeln.
- Mit Ravioli-Aufsatz erhältlich.



Regulador de grosor de pasta (3,4 mm - 0,93 mm)
Pasta thickness Regulator (3,4 mm - 0,93 mm)



Máquina laminadora pasta

Machine Lamineuse à pâte · Pastamaschine
Pasta Machine Slicer · Máquina de Pasta

	Ref	€	mm	U.Venta
A	60390	45,40	145	1
B	60391	83,80	260	1



Accesorio para ravioli

Accessoire pour raviolis · Zubehör für Ravioli
Ravioli maker · Accesorio para ravióis

	Ref	€	Columnas	Ravioli	U.Venta
A	60497	21,80	2	45x45 mm	1
B	60498	21,80	3	30x30 mm	1

Solo puede utilizarse en la máquina de 145 mm (Ref: 60390)
Only can be used in the machine of 145 mm (Ref: 60390)

Inox
18/10



Medidor de pasta Inox

Mesureur pour pâtes en Inox · Spaghetti-Mass Rostfrei
St steel pasta measurer · Medidor para macarrao en Inóx

	Ref	€	cm	U.Venta
A	62942	3,30	18	1
B	62943	4,60	11x9	1

EMBUTIDORA

Máquina

Inox
18/10



Incluye boquillas
Includes nozzles



Embutidora manual

Poussoir manuel · Manuelle Wurstfüller
Manual stuffer · Máquina para encher salsichas manual

Ref	€	L	Cilindro (cm)	U.Venta
60253	278,70	3	Ø14 x 20	1
60255	319,50	5	Ø14 x 32	1
60257	368,40	7	Ø14 x 46	1
60251	424,30	10	Ø22 x 27	1

CLIPADORA

Máquina

Inox



200
Grapas
Clips

GRAPAS · STAPLES
Ref: 61201
No incluidas · Not included

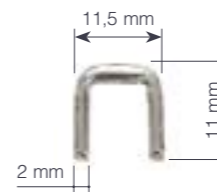

Regulación de presión
Pressure adjustment

Clipadora de alimentos

Clippeuse d'aliments · Lebensmittelzacker
Food clipping machine · Agrafadora para alimentos

Ref	€	cm	h (cm)	U.Venta
61200	299,50	37x15	58,5	1
61201	22,10	4,6 - 6	-	1

Grapas (4000 unid.)
Staples (set of 400)

- Fabricada en acero inoxidable de máxima calidad.
- Diseñada para grapar embutidos, mallas de fruta, bolsas, etc. con el mínimo esfuerzo.
- Accionamiento manual fácil y muy cómodo.
- Sistema de apoyo de zamak macizo que garantiza una estabilidad máxima.
- Capacidad de grapas: 200 unidades (ref: 61201 - no incluidas).
- Fácil de limpiar.

- Fabriqué en acier inoxydable de la plus grande qualité.
- Conçue pour agraffer de la charcuterie, des filets de fruits, des sachets, etc. avec un minimum d'efforts.
- Actionnement manuel facile et très pratique.
- Base en zamak massif qui garantit une stabilité maximale.
- Capacité d'agrafes : 200 unités (réf. : 61201 - non incluses).
- Facile à nettoyer.

- Made of top-quality stainless steel.
- Designed to staple sausages, fruit nets, bags, etc. with minimal effort.
- Easy, very comfortable manual operation.
- Solid zamak support system ensuring maximum stability.
- Staple capacity 200 units (ref: 61201 - not included).
- Easy to clean.

CENTRIFUGADORAS

Colección



ES

- Diseñadas para escurrir ensaladas y verduras.
- Gracias a su gran velocidad de centrifugado escurren la lechuga y las verduras en segundos.
- Fácil manejo gracias a su palanca EasySpeed (61400).
- Fácil manejo gracias al pomo giratorio ergonómico (61422 / 61404 / 61405).
- Versátiles: están compuestas por 3 piezas: tapa (61422: vertedor-escurridor integrado), rejilla y bol, perfecto para servir la ensalada en el mismo recipiente.
- Base antideslizante y 100% estable.
- Fácil limpieza: apto para el lavavajillas.
- 100% Libre de BPA.

FR

- Conçue pour essorer des salades et des légumes.
- Grâce à sa grande force centrifuge, elle essore la salade et les légumes en quelques secondes.
- Facile à manipuler grâce à son levier EasySpeed (61400).
- Manipulation facile grâce au pommeau rotatif ergonomique (61422 / 61404 / 61405).
- Versatiles : composée de 3 pièces : couvercle avec bec verseur intégré, panier grillagé et saladier, parfait pour y servir la salade.
- Base antidérapante et 100% stable.
- Nettoyage facile : apte pour le lave-vaisselle.
- 100% sans BPA.

EN

- Designed for removing excess water from salads and vegetables.
- Because of its high centrifuge speed it can strain salads and vegetables in seconds.
- Easy to use because of its EasySpeed lever (61400).
- Easy to handle because of the ergonomic rotating handle (61422 / 61404 / 61405).
- Versatile: they are made up of 3 pieces: lid (61422: integrated pourer-drainer), lid, grate, bowl, perfect for serving salad right from the container.
- Easy to clean. Dishwasher safe.
- 100% BPA free.



700 r.p.m.

Click here



Centrifugadora WHITE

Essoreuse · Salatschleuder
Spinner · Centrifugadora

Ref	€	Ø (cm)	L	U.Venta
61403	29,60	26x20	5,00	1



Centrifugadora SPIN

Essoreuse · Salatschleuder
Spinner · Centrifugadora

Ref	€	Ø (cm)	L	U.Venta
61404	79,00	24	4,00	1

Inox 18/10



Tapa hermética
Hermetic lid

Tapa centrifugadora
Spinner lid

Escurridor
Colander

Bol antideslizante
Non-slip bowl



Ideal para servir y guardar alimentos
Ideal for serving and storing food

Centrifugadora INOX

Essoreuse · Salatschleuder
Spinner · Centrifugadora

Ref	€	Ø (cm)	L	U.Venta
61405	98,70	24	4,50	1

Para uso profesional, sencillo y eficaz
For professional use, simple and efficient



Tapa accionamiento de giro
Turn drive cover



Centrifugadora profesional

Essoreuse à salade · Salatschleuder
Salad spinner drier · Centrifugadora professional

Ref.	€	Ø (cm)	h (cm)	L	U.Venta
61420	202,40	32	33	12,0	1
61425	225,60	42	40	25,0	1

*Article non vendu en France



Centrifugadora KLEIN

Essoreuse · Salatschleuder
Spinner · Centrifugadora

Ref	€	cm	L	Ø Bol (cm)	Rejilla (cm)	U.Venta
61422	19,10	Ø20,5x19	2,6	Ø18,5x13	Ø17x10	1



Sistema de accionamiento
Drive system



Sistema de frenado
Brake system



Centrifugadora MINI

Essoreuse · Salatschleuder
Spinner · Centrifugadora

Ref	€	cm	L	Ø Bol (cm)	Rejilla (cm)	U.Venta
61400	18,40	Ø19x16	1,8	Ø18,5x11,5	Ø18x10	1

MECHAR

Aguja

Inox 18/10
Dishwasher

Puntiaguda y alargada
Pointed and elongated shape



Doble superficie dentada para una perfecta sujeción
Double-toothed surface for optimal grip

Aguja de mechar
Aiguille à larder · Spicknadel
Stuffing needle · Agulha de mechar

Ref	€	L (cm)	U.Venta
61362	4,80	19	6

Carnes y pescados más jugosos

Meats and fish juicier

- Su forma puntiaguda y alargada, permite abrir orificios fácilmente en la carne o pescado e insertar tiras de beicon, verduras, frutas, quesos o especias.
- Sistema de amarre con doble superficie dentada para una perfecta sujeción.
- Consigue carnes más sabrosas y pescados más jugosos.
- Apta para lavavajillas.

· Sa forme pointue et allongée permet d'ouvrir facilement des orifices dans la viande ou le poisson et d'y insérer du bacon, des légumes, des fruits, du fromage ou des épices.

· Système d'adhérence avec double surface dentée pour une meilleure fixation.

· Obtenez des viandes plus savoureuses et des poissons plus juteux.

· Apte pour le lave-vaisselle.

· Its pointed and elongated shape allows easy opening of holes in meat or fish and inserting strips of bacon, vegetables, fruits, cheeses or spices.

· Fastening system with double-toothed surface for optimal grip.

· Get tastier meats and juicier fish.

· Dishwasher safe.

COCINA

Jeringa & pipetas

ASA
Acrylic Dishwasher BPA free

ES
· Inyecta salsas o especias.
· Extrae la salsa para reducirla en la sartén.



Jeringa para cocina
Seringue pour cuisine · Spritze Küche
Kitchen syringe · Seringa para cozinha

Ref	€	ml	Unidades	U.Venta
61418	6,00	30	ml-oz-tsp-Tbsp	6

FR
· Injecter des sauces ou des épices.
· Extraire du plat afin de les réduire dans une poêle à feu vif.



EN
· Syringe to inject sauces or spices.
· Extract them to separately reduce them in a frying pan.



Pipeta para salsa
Poire à jus · Sossenspritze
Sauce syringe · Pipeta para molho

	Ref	€	L (cm)	ml	U.Venta
A	61408	17,60	30	40	1
B	61416	12,90	30	40	1

BOTELLAS BIBERÓN

Colección

PE PELD
Polyethylene Polyethylene BPA free



ES
· Ideales para salsas, cremas, aceites, aliños, vinagretas y todo tipo de condimentos líquidos.
· Dibuja, adorna y personaliza con estilo tus platos.

FR
· Idéal pour les sauces, les crèmes, les huiles, les assaisonnements, les vinaigrettes et tout type de condiments liquides.
· Il dessine, décore et personnalise les plats.

EN
· Ideal for sauces, creams, oils, dressings, vinaigrettes and all kinds of liquid condiments.
· Draw, decorate and personalize your dishes with style.

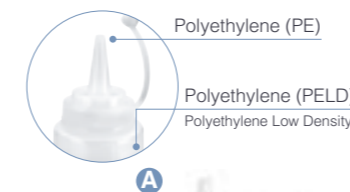

3
Boquillas
Nozzles

Botella biberón
Bouteille biberon · Dosierflasche
Squeeze bottle · Garrafa

Ref	€	Ø (cm)	L	U.Venta
61974	4,00	7x20	0,47	6
61977	4,30	7x26	0,71	6



Botella biberón
Bouteille biberon · Dosierflasche
Squeeze bottle · Garrafa

	Ref	€	Ø (cm)	L	U.Venta
	61912	1,50	4x10	0,12	12
	61925	1,60	5x19	0,25	12
A	61940	1,70	5,5x21,5	0,40	12
	61970	1,90	7x26	0,70	12
	61925R	1,60	5x19	0,25	12
B	61940R	1,70	5,5x21,5	0,40	12
	61970R	2,00	7x26	0,70	12
	61925A	1,60	5x19	0,25	12
C	61940A	1,70	5,5x21,5	0,40	12
	61970A	2,00	7x26	0,70	12

Botella biberón PUSH
Bouteille biberon · Dosierflasche
Squeeze bottle · Garrafa

Ref	€	Ø (cm)	L	U.Venta
61978	4,50	6x20	0,50	1
61979	4,60	7x20	0,60	1
61980	4,80	7x26	0,70	1

Biberón decoración
Biberon à decorer · Dekorierflasche
Decorating pen · Garrafa decoração

Ref	€	Ø (cm)	L	U.Venta
64457	9,50	5,5x16	0,14	1

DOSIFICADORES

Colección

Inox
18/10
Dishwasher



Salado · Salty



Dulce · Sweet

ES

- Ideal para rellenar o decorar platos con salsas y cremas calientes y frías.
- Sistema de palanca para un caudal ajustable; práctico y preciso.
- Sistema antigoteo y antisalpicaduras.
- Mango con diseño ergonómico que permite el manejo con una sola mano.
- Fácil desmontaje para una sencilla limpieza. Apto para el lavavajillas.

FR

- Idéal pour remplir ou décorer des assiettes avec des sauces chaudes et froides.
- Système de piston pour un débit ajustable ; pratique et précis.
- Système anti-goutte et anti-éclaboussures.
- Manche ergonomique qui permet de le manipuler d'une seule main.
- Facile à démonter pour un nettoyage aisé, et apte pour le lave-vaisselle.

EN

- Perfect for filling or decorating dishes with hot or cold sauces and cream.
- Its lever system for controlling the flow is practical and precise.
- Anti-drip and anti-splash system.
- The ergonomic handle means it can be used with just one hand.
- It's easy to disassemble for easy cleaning and it's dishwasher safe.



Marcas de medición
(ml - cup)
Measuring marks
(ml - cup)

Dosificador
Entonnoir à decor · Dosierer
Portionner · Dosificador

Ref	€	cm	h (cm)	L	U.Venta
67026	11,80	16x11	18	1,0	1



Incluye soporte y un
platinillo antigoteo
Includes support
and a drip dish

Dosificador INOX
Entonnoir à decor · Dosierer
Portionner · Dosificador

Ref	€	Ø (cm)	h (cm)	L	U.Venta
67150	61,60	19	27	2,0	1
R67150B	19,90	4/6/8			1

Set 3 boquillas
Set 3 nozzles



Salado · Salty



Dulce · Sweet

Sistema de gatillo para un caudal ajustable
Trigger system for an adjustable flow



3
Boquillas
Nozzles

Dosificador RATION
Entonnoir à decor · Dosierer
Portionner · Dosificador

Ref.	€	L	U.Venta
67000	88,60	2,00	1



Cono
Cône · Trichter
Cone · Cone

Ref.	€	L	U.Venta
R67000	39,30	2,00	1

Diseño premiado en certámenes internacionales
Award-winning design in international competitions



Soporte mango
Support · Stütze
Support · Suporte cabo

Ref.	€	U.Venta
R67001	35,40	1



Base negra
Base noire · Ständer, schwarz
Black base · Base negra

Ref.	€	U.Venta
R67002	13,90	1



Boquillas
Douille · Düse
Nozzle · Boquilhas

	Ref.	€	Ø (mm)	U.Venta
A	R67003	1,60	1	1
B	R67004	1,80	4	1
C	R67005	1,80	6	1
D	R67006	1,80	8	1

SIFONES

Colección

AL
Aluminium Dishwasher

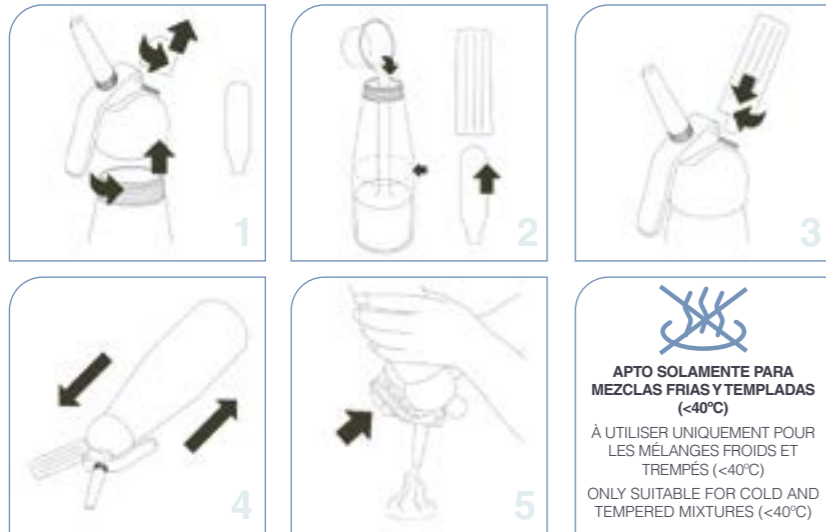

APTO SOLAMENTE PARA MEZCLAS FRIAS Y TEMPLADAS (<40°C)
À UTILISER UNIQUEMENT POUR LES MÉLANGES FROIDS ET TREMPÉS (<40°C)
ONLY SUITABLE FOR COLD AND TEMPERED MIXTURES (<40°C)

EXCLUSIVAMENTE PARA USO ALIMENTICIO
EXCLUSIVELY FOR FOOD USE



Cargas sifón N2O

Cartouches N₂O pour siphon · N₂O Kapsel für Sahnebereiter
N₂O cream charger · Botijas de sifão N₂O

Ref	€	Botellas	g	U.Venta
68402	8,30	10	8	1
68403	19,40	24	8	1

New

Sifón EPICURE

Siphon à crème · Sahnebereite
Cream whipper · Sifão creme



Ref	€	Ø (cm)	L	U.Venta
68300	104,70	9,0	0,50	1
68301	118,90	9,0	1,00	1

Temperatura de uso · Use temperature
min = +5°C / max = +70°C

- Cuerpo y cabezal fabricado en acero inoxidable 18/10 de gran calidad.
- Marcaje de llenado grabado en el exterior del cuerpo.
- Versátil: Diseñado para espumas frías y espumas calientes.
- Incluye 3 boquillas de acero inoxidable con formas decorativas.
- Funciona con cargas de gas (N₂O).
- Cepillo limpiador para facilitar la limpieza. Apto para el lavavajillas.

- Corps et tête fabriqués en acier inoxydable 18/10 de grande qualité.
- Marquage de remplissage gravé à l'extérieur du corps.
- Versatile : conçu pour des préparations froides et chaudes.
- Inclut 3 douilles en acier inoxydable avec des formes décoratives.
- Fonctionne avec des cartouches de gaz (N₂O).
- Brosse pour faciliter le nettoyage. Compatible avec le lave-vaisselle.

- Top-quality 18/10 stainless steel body and head.
- Embossed filling marks on the outside.
- Versatile: designed for whipping up hot or cold foams.
- Includes 3 stainless steel nozzles with decorative shapes.
- Charged with gas cartridges (N₂O).
- Cleaning brush for easy cleaning. Dishwasher safe.



Sifón MIX

Siphon à crème · Sahnebereite
Cream whipper · Sifão creme

Ref	€	Ø (cm)	L	U.Venta
68404	100,00	7,8x25	0,50	1
68405	114,90	9,3x32,5	1,00	1

Temperatura de uso · Use temperature
min = +5°C / max = +40°C



Sifón WHITE

Siphon à crème · Sahnebereiter
Cream whipper · Sifão creme

Ref	€	Ø (cm)	L	U.Venta
68502	40,60	9x27	0,25	1
68500	48,10	9x31	0,50	1
68501	53,60	11x36	1,00	1

Temperatura de uso · Use temperature
min = +5°C / max = +40°C



Sifón BLACK

Siphon à crème · Sahnebereiter
Cream whipper · Sifão creme

Ref	€	Ø (cm)	L	U.Venta
68604	50,70	7,8x27,3	0,50	1
68605	55,90	9,3x32,5	1,00	1

Temperatura de uso · Use temperature
min = +5°C / max = +40°C

NUNCA ponga los sifones al baño maría, puede producirse una explosión con graves consecuencias.
NE JAMAIS mettre les siphons au bain marie car une explosion pourrait avoir lieu et provoquer de graves conséquences.
NEVER put siphons in a water bath, as this may cause an explosion with serious consequences.

AHUMADORES

Colección

AL
Aluminium Dishwasher



69221 - 69321
Incluyen bolsa de serrín (100 g)
Wood Chips bag included (100 g)
Olivo · Olive

ES

- Técnica popular de la cocina creativa; otorga a los platos aromas especiales y personalizados.
- Perfecto para ahumar todo tipo de alimentos (carnes, pescados, quesos...).
- La construcción y su diseño facilitan la limpieza y el mantenimiento.
- Ideal para presentar y terminar platos delante del cliente.
- Incluye un set de filtros de recambio.
- Fácil de transportar gracias a su forma y tamaño.
- Pilas no incluidas.
- Compatible con nuestras campanas de ahumado y la tapa

FR

- Technique populaire de la cuisine créative; qui confère aux plats des arômes spéciaux et personnalisés.
- Parfait pour fumer tout type d'aliments (viandes, poissons, fromages...).
- La fabrication et la conception de chacune de ses parties facilite son nettoyage et son entretien.
- Idéal pour présenter et apporter la touche finale à des plats devant le client.
- Inclut un set de filtres de rechange.
- Facile à transporter grâce à sa forme et sa taille.
- Piles non incluses.
- Compatible avec nos cloches de fumage et à couvercle

EN

- A popular creative cooking technique which gives dishes special and personalised aromas.
- Perfect for smoking all kinds of foods (meat, fish, cheeses...).
- The way is designed and constructed makes it easy to clean and maintain.
- Ideal for presenting and finishing dishes in front of the customer.
- Includes a set of replacement filters.
- Easy to transport thanks to its shape and size.
- Batteries not included.
- Compatible with our smoking cloches and the lid.



Ahumador de alimentos

Fumoir pour aliments · Apparat zum Räuchern von Lebensmitteln
Food smoker · Defumador de alimentos

	Ref	€	U.Venta
A	69221	46,30	1
B	69321	62,10	1

- Permite ahumar dos platos a la vez, ahorrando tiempo.
- Incluye 2 mangueras de goma de 40 cm, 2 boquillas y un conector de conexión de mangueras.

- Il permet de fumer deux plats à la fois, économisant ainsi du temps.
- Il comprend deux tuyaux en caoutchouc de 40 cm, deux embouts et un raccord de tuyaux.

- Two dishes can be smoked at once to save time.
- Two 40 cm rubber hoses, two nozzles and a hose connector included.



Mangueras de goma flexible
Flexible rubber hoses

Goma
Rubber



Manguera doble para ahumador

Double tuyau pour fumoir · Doppelschlauch für Räucherapparat
Double hoses for smoker · Manguera dupla para defumador

	Ref	€	U.Venta
	69521	8,50	1

CAMPANAS/TAPA AHUMAR

Colección

Vidrio Si
Glass Silicone Dishwasher

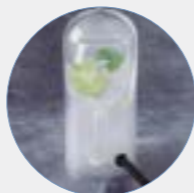
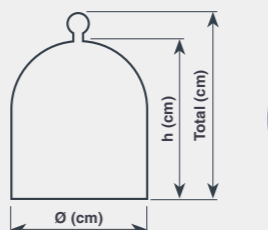
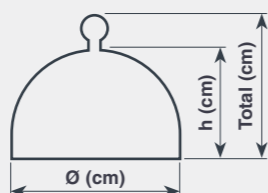

- Fabricada en vidrio borosilicato de gran calidad, es resistente a golpes, altas y bajas temperaturas.
- Permite la entrada de humo, vapor y aromas para ahumar o aromatizar alimentos/cócteles sin tener que levantar la tapa.
- Cuenta con una válvula de inyección con autocierre de silicona (max. 200° C).
- Aptas para microondas, horno y congelador.
- Complemento ideal para los ahumadores de alimentos Magic (ref. 69221) e Instant (ref. 69321).

- Fabriquées en verre borosilicate de grande qualité, elles sont résistantes aux chocs ainsi qu'aux hautes et basses températures.
- Permettent l'entrée de fumée, de vapeur et d'arômes pour fumer ou aromatiser les aliments/cocktails sans avoir à soulever le couvercle.
- Disposent d'une valve à injection avec fermeture automatique en silicone (max. 200°C).
- Aptes pour micro-ondes, four et congélateur.
- Complément idéal pour les fumoirs d'aliments Magic (réf. 69221) et Instant (réf. 69321).

- Made of high quality borosilicate glass, the hood withstands shocks, high and low temperatures.
- Allows smoke, steam and aromas in, to smoke or flavour food/cocktails without having to lift the lid.
- It has a self-closing silicone injection valve (max. 200° C).
- Microwave, oven and freezer safe.
- Ideal complement for Magic (ref. 69221) and Instant (ref. 69321) food smokers.

Campana ahumador
Cloche à fumer · Räucherglocke
Smoker Hood · Campânula defumadora

	Ref	€	Ø (cm)	h (cm)	Total (cm)	U.Venta
A	61813	13,40	12,5	7,5	11,0	1
B	61815	22,00	16,0	12,0	15,0	1
C	61816	24,30	20,0	12,0	15,0	1
D	61817	41,50	25,0	14,0	17,0	1
E	61811	28,10	18,5	22,0	25,0	1
F	61812	33,50	12,5	26,5	30,0	1

Para cocteles
For cocktails



Tapa para ahumar
Chapeau de fumée · Rauchdeckel
Smoke cap · Tampa de fumaça

Ref	€	Ø (cm)	U.Venta
69554	4,10	12	1

ASA Si
Acrylic Silicone

- Tapa en forma de CD para crear un efecto hermético al momento de ahumar.
- Válido para todo tipo de envases, vasos, cocteleras, tarros, etc.
- Ideal para ahumar cócteles, destilados, comidas, quesos, etc.
- Válvula de inyección con autocierre de silicona (200°C).

- Couvercle en forme de CD pour créer un effet hermétique lors du fumage.
- Apte pour tout type de contenants, verres, shakers, pots, etc.
- Idéal pour fumer des cocktails, des alcools distillés, des plats, des fromages, etc.
- Valve à injection avec fermeture automatique en silicone (200°C).

- Lid in the shape of a CD for creating a hermetic effect while smoking meats.
- Can be used with all kinds of container, glasses, cocktail glasses, jars, etc.
- Perfect for smoking cocktails, liquors, food, cheese, etc.
- Injection valve with silicone self seal (200°C).

SERRÍN AHUMAR

Colección



Serrín de madera
Scire de bois · Räuchermehl
Wood chips · Serrín de madeira

	Ref	€	g	U.Venta	
A	69550	7,00	100	1	Olivo · Olive
	69551	7,00	100	1	Naranja · Orange
	69552	7,00	100	1	Limonero · Lemon
	69553	7,00	100	1	Almendro · Almond
	69559	7,00	100	1	Whisky
	69560	7,00	100	1	Cognac
B	69555	9,50	600	1	Olivo · Olive
	69556	9,50	600	1	Naranja · Orange
	69557	9,50	600	1	Limonero · Lemon
	69558	9,50	600	1	Almendro · Almond
	69567	9,00	500	1	Whisky
	69568	9,00	500	1	Cognac

Natural 100% Quality

La mejor elección para ahumar
todo tipo de alimentos
The best choice to smoke all
kinds of food

- OLIVO: aporta a los alimentos un sabor suave y aromático.
- NARANJO: aporta a los alimentos un sabor dulce, afrutado y el frescor de los cítricos.
- LIMONERO: aporta a los alimentos un toque cítrico y dulce muy suave.
- ALMENDRO: aporta a los alimentos un aroma suave, dulce y floral de la almendra.
- WHISKY: aporta a los alimentos un aroma de barril de roble empleado para el reposo del Whisky
- COGNAC: aporta a los alimentos un aroma de barril de roble empleado para el reposo del Cognac.
- Producen un humo denso y de alta calidad.
- Cumplen todas las normativas y reglamentaciones existentes para el empleo con alimentos.

- OLIVE: apporte aux aliments un goût doux, fruité et la fraîcheur des agrumes.
- ORANGE: apporte aux aliments un arôme délicat, doux et floral d'amande.
- CITRONNIER: apporte aux aliments une touche d'agrumes douce et très délicate.
- AMANDIER: apporte aux aliments un arôme délicat, doux et floral d'amande.
- WHISKY: apporte aux aliments un arôme de fut de chêne utilisée pour le vieillissement du whisky.
- COGNAC: apporte aux aliments un arôme de fut de chêne utilisée pour le vieillissement du cognac.
- Produit une fumée dense et de grande qualité.
- Respecte toutes les normes et réglementations existantes pour un usage alimentaire.

- OLIVE: provides food a smooth and aromatic flavour.
- ORANGE: provides food a sweet, fruity taste and citrusy freshness.
- LEMON: provides food a very soft sweet citrusy touch.
- ALMOND: provides food with a soft, sweet, floral aroma of almonds.
- WHISKY: aromatic sawdust from the oak barrel used for ageing the whiskey.
- COGNAC: aromatic sawdust from the oak barrel used for ageing the cognac.
- Produces dense, high-quality smoke.
- Meets all existing regulations and standards for use with food.

PROFESIONALES

Básculas

Inox 



Cabezal orientable y abatible
Retractable, swivelling head

Cuerpo aluminio fundido
Cast aluminium case

Plataforma inoxidable 53x44cm
St. Steel platform, 53x44 cm

Báscula industrial con base

Balance industrielle avec base · Industrieller Küchenwaage mit Sockel
Industrial scale with base · Balança industrial com base

Ref	€	U.Venta
61700	1146,70	1

Plataforma inoxidable 30x24 cm
Plataforma extraíble
Doble display (Delante / Detrás)
Teclado intuitivo y de fácil uso
Patas de apoyo regulables

St. Steel platform, 30x24 cm
Removable platform
Double display (Front / Back)
Intelligent and easy-to-use keyboard
Adjustable support feet



Báscula profesional electrónica

Balance électronique professionnelle · Elektronische Profi-Waagen
Electronic professional scale · Balança eletrônica profissional

Ref	€	Tara
61716	472,20	15kg/5g
61730	508,10	30kg/10g

- **Batería interna recargable (autonomía de 15 días).**
- **Visor de nivel, planitud.**
- **Avisador acústico de sobrecarga.**
- **Teclado intuitivo y de fácil uso. Funciones de calculadora.**
- **Acumulación de importes.**
- **Unidades de medida (Kg · oz · Libras). Función de tara.**
- **Libro de instrucciones en 7 idiomas.**

- Batterie interne rechargeable (autonomie 15 jours).
- Indicateur de niveau, de planité.
- Avertisseur acoustique de surcharge.
- Clavier intuitif d'utilisation facile. Fonctions de calculatrice.
- Accumulation de sommes
- Unités de mesure: (Kg · Oz · Livres). Fonction de tare
- Mode d'emploi en 7 langues

- Rechargeable internal battery (last 15 days).
- Level and fatness indicator .
- Overload alarm.
- Intelligent and easy-to-use keyboard. Calculator funtions. Total counter.
- Measurement units: (Kg · Oz · pounds). Tare function
- Instructions book in 7 languages.

Características - Characteristics:

Referencia · Reference: 61700
Tensión · Voltage: 220-240 V; 50-60 Hz
Tara · Tare: 150 Kg (20 g)
Dimensiones · Sizes: 49x75x90 cm
Peso · Weight: 45 kg

CERTIF.: 89/336/ECC, 91/263/EEC, 92/31/ECC, 93/68/EEC en 50 082 - 1:1992

- **Batería interna recargable (autonomía 15 días).**
- **Visor de nivel, planitud.**
- **Avisador acústico de sobrecarga.**
- **Funciones cambio.**
- **Seis memorias programables.**
- **Unidades de medida (Kgs., Oz., Libras). Función de tara.**
- **Libro de instrucciones en 7 idiomas.**

- Batterie interne rechargeable (Autonomie 15 jours).
- Indicateur de niveau, de planité.
- Avertisseur acoustique de surcharge.
- Fonctions changement.
- Six mémoire programmable.
- Unités de mesure: (Kgs., Oz, Livres). Fonction de tare.
- Mode d'emploi en 7 langues.

- Rechargeable internal battery (Last 15 days).
- Level and fatness indicator.
- Overload alarm.
- Change funtions.
- Six programmable memories.
- Measurement units: (Kgrs, Oz, pounds). Tare function.
- Instructions book in 7 languages.

Características - Characteristics:

Referencia · Reference: 61716
Tensión · Voltage: 220-240 V; 50-60 Hz
Potencia · Power: 0,2 W (máx)
Tara · Tare: 15 Kg (5 g)
IP · IP: IPX 54
Dimensiones · Sizes: 30x32x12 cm
Peso · Weight: 4,60 kg

Características - Characteristics:

Referencia · Reference: 61730
Tensión · Voltage: 220-240 V; 50-60 Hz
Potencia · Power: 0,2 W (máx)
Tara · Tare: 30 Kg (10 g)
IP · IP: IPX 54
Dimensiones · Sizes: 30x32x12 cm
Peso · Weight: 4,60 kg

CERTIF.: OIML R76 Clase III, 60/384/ECC

No válidas para uso comercial · Utilisation interdite pour toutes transactions commerciales · Not for trade

Básculas - Termómetros
Scales - Termometers

ELECTRÓNICAS

Básculas de cocina

Inox 18/10 



Báscula de cocina CRISTAL

Balance de cuisine · Küchenwaage
Kitchen scale · Balança de cozinha

Ref	€	Kg	División (g)	U.Venta
61725	22,60	5	1	1



Báscula digital con bol extraíble

Balance numérique avec bol amovible · Digitalwaage mit abnehmbarer Schale
Scale digital with removable bowl · Balança digital con bacia removível

Ref	€	Ø (cm)	L	Kg	División (g)	U.Venta
61707	36,90	21 (bol)	1,50	5	1	1

ES

- Básculas perfectas para cualquier cocina.
- Función tara.
- Reseteo automático a cero.
- Pantalla LCD, fácil lectura de los resultados.
- Función de apagado automático, ahorrar energía.
- Indicador de batería baja y sobrecarga.

FR

- Balances parfaites pour toutes les cuisines.
- Fonction tare.
- Mise à zéro automatique.
- Écran LCD, lecture facile des résultats.
- Fonction d'arrêt automatique pour permettre des économies d'énergie.
- Indicateur de batterie faible et de surcharge.

EN

- This scales is perfect for any kitchen.
- Tare function.
- Automatic reset to zero.
- LCD screen with easy to read results.
- Automatic shut-off to save energy.
- It has a low battery and overload indicator.

15 Kg



4 sensores de alta precisión
Four high precision sensors

Báscula de cocina EBEN

Balance de cuisine · Küchenwaage
Kitchen scale · Balança de cozinha

Ref	€	Kg	División (g)	cm	Unidades	U.Venta
61717	54,70	15	1	31x25,6x2,5	g/Kg/oz/lb/oz	1

Cristal
Glass



Báscula de cocina SLIM

Balance de cuisine · Küchenwaage
Kitchen scale · Balança de cozinha

Ref	€	Kg	División (g)	cm	Unidades	U.Venta
61708	27,30	5	1	27x18x4	g/oz/ml/cups	1

Bambú
Bamboo



Báscula de cocina BAMBOO

Balance de cuisine · Küchenwaage
Kitchen scale · Balança de cozinha

Ref	€	Kg	División (g)	cm	Unidades	U.Venta
61712	23,80	5	1	21,8x18,8x2,1	g/ml/lb/oz/fl-oz	1



Báscula de cocina ROUND

Balance de cuisine · Küchenwaage
Kitchen scale · Balança de cozinha

Ref	€	Kg	División (g)	cm	U.Venta
61703	60,20	5	1	15,5x12	1

ECO

Básculas de cocina

- Tecnología sin pilas ni baterías: se carga mediante el giro de la ruleta.
- Sistema EcoMove: convierte la energía cinética (energía en movimiento) en energía eléctrica.
- 61720: Fabricado en cristal templado de 4 mm de grosor y acabado con efecto mármol. Extraplano. Medición de alta precisión. Capacidad máx. de 5 kg con una división de 1 g.
- 61719: Recipiente desmontable que facilita la mezcla de los ingredientes. Libre de BPA.
- Pantalla LCD retroiluminada: facilita la lectura de los datos.
- Muestra los resultados en g (gramos), oz (onzas), lb:oz (onzas líquidas), ml-agua (mililitros- agua) y ml-leche (mililitros-leche).
- Función tara. Apagado y reseteo automático.
- Cuatro pies anti-deslizantes que proporcionan máxima estabilidad y seguridad.

- Battery Free Technology: Charged by turning the wheel.
- EcoMove System: converts kinetic energy (movement) into electric energy.
- 61720: Made of 4 mm thick tempered glass with a marble effect finish. Extra-flat design. High precision measurement. Maximum capacity 5kg with 1g divisions.
- 61719: The removable container makes it easy to mix ingredients. BPA free.
- Backlit LCD Screen: makes reading information easy.
- Shows results in g (grams), oz (ounces), lb:oz (fluid ounces), ml-water (millilitres - water) and ml-milk (millilitres-milk).
- Tare function. Automatic shutdown and reset.
- The four non-slip feet provide maximum stability and safety.

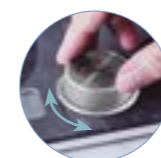

Sistema EcoMove
EcoMove system



Báscula de cocina ECO MARMOL

Balance de cuisine · Küchenwaage
Kitchen scale · Balança de cozinha

Ref	€	Kg	División (g)	cm	U.Venta
61720	34,50	5	1	19x23,5x3,5	1



Sistema EcoMove
EcoMove System



Báscula de cocina ECO

Balance de cuisine · Küchenwaage
Kitchen scale · Balança de cozinha

Ref	€	kg	Division (g)	Units	U.Venta
61719	29,80	5	1	g / oz / lb:oz ml-agua/water / ml-leche/milk	1

MECÁNICAS

Básculas de cocina

Inox
18/10



Báscula de cocina

Balance de cuisine · Küchenwaage
Kitchen scale · Balança de cozinha

	Ref	€	Kg	División (g)	Ø Bol (cm)	U.Venta
A	61705	55,20	5	20	20,5x4	1
	61710	56,90	10	50	20,5x4	1
B	61715	85,80	15	50	-	1



Báscula de cocina WHITE

Balance de cuisine · Küchenwaage
Kitchen scale · Balança de cozinha

	Ref	€	Kg	División (g)	Bol (L)	U.Venta
A	61714	37,20	5	20	2,0	1
B	61702	20,10	1	2	2,0	1

PRECISIÓN

Básculas de cocina

- Diseñadas para un pesaje muy preciso.
- Elabore recetas vanguardistas. La precisión de estas básculas ayudará a pesar los ingredientes más exclusivos.
- Compacta, ahorra espacio de almacenamiento.
- Plataforma de pesaje de acero inoxidable de máxima calidad (61709-61711).

- Designed for very precise weighing. Create nuanced recipes.
- The precision of this scale will help you weigh the most exclusive ingredients.
- Compact, to help save storage space.
- Weighing platform made of high quality stainless steel (61709-61711).

Muestra los resultados en gramos (g) y onzas (oz)
Shows the results in grams (g) and ounces (oz)



Cuchara medidora digital

Cuillère avec Balance Digital · Digitale Löffelwaage
Digital spoon scale · Colher de pesar Digital

Ref	€	g	División (g)	L (cm)	U.Venta
62519	39,50	300	0,10	28	1

Muestra los resultados en gramos (g), onzas (oz), onzas troy (ozt) y quilate (ct)
Shows the results in grams (g), ounces (oz), troy ounces (ozt) and carat (ct).



11x13x2 cm 10,5x10,5x0,5 cm
Incluye 2 bandejas para el pesaje (ABS plastic)
Includes 2 weighing trays

Báscula de precisión

Balance de précision · Präzisionswaage
Precision scale · Balança de precisão

	Ref	€	Kg	División (g)	cm	U.Venta
A	61709	17,10	0,65	0,1	13x8x2	1
B	61711	17,90	2,00	0,1	12,7x10,6x1,7	1

Inox
CE
BPA free

GANCHO

Básculas

Inox
18/10
CE



Báscula con gancho

Balance électronique avec crochet · Elektronischeküchenwaage mit Haken
Electronic scale w/hook · Balança de gancho

	Ref	€	Kg	División (g)	U.Venta
A	61721	22,70	10	5	1
B	61722	72,60	0 - 50 50 - 150	20 100	1

BAÑO

Básculas

Inox
18/10
CE



Sistema EcoMove
EcoMove System



Báscula de baño ECO

Pèse personne · Personenwaage
Bathroom scale · Escala de banheiro

Ref	€	Kg	División (g)	cm	U.Venta
61742	38,50	180	100	31x29x5	1



Báscula de baño

Pèse personne · Personenwaage
Bathroom scale · Escala de banheiro

Ref	€	Kg	División (Kg)	cm	Unidades	U.Venta
61740	33,10	180 (397lb)	0,1 (0,22lb)	31x31x4	Kg / lb	1

- Tecnología sin pilas ni baterías: se carga pulsando el botón central.
- Sistema EcoMove: convierte la energía cinética (energía en movimiento) en energía eléctrica.
- Fabricado en cristal templado de 5 mm de grosor y acabado con efecto mármol.
- Medición de alta precisión: accionado por 4 sensores de peso de máxima precisión. Amplio rango de medición, desde los 8 kg hasta los 180 kg (máx.) con una división de 100 g.
- Pantalla LCD retroiluminada: facilita la lectura de los datos.
- Muestra los resultados en Kg (kilogramos) y lb (libras).
- Apagado y reseteo automático.
- Cuatro pies antideslizantes que proporcionan máxima estabilidad y seguridad.

- Battery Free Technology: Charged by pushing the button in the middle.
- EcoMove System: converts kinetic energy (movement) into electric energy.
- Made of 5mm thick tempered glass with a marble effect finish.
- High Precision Measurement: activated by 4 maximum precision weight sensors. Wide measurement range from 8kg up to 180kg (max) with 100g divisions.
- Backlit LCD Screen: makes reading information easy
- Shows results in Kg (kilograms) and lb (pounds)
- Automatic shutdown and reset
- The four non-slip feet provide maximum stability and safety.

COCINA

Termómetros & relojes



Termómetro analógico de aceite

Thermometre analogique de huile · Analog Thermometer für Öl
Oil analogic thermometer · Termómetro analógico óleo

Ref	€	cm	Temp.	U.Venta
62495	12,40	5x30,5	40°C (104°F) 200°C (392°F)	1



A Horno · Oven **B** Refrigerador · Refrigerator **C** Carne · Meast

Termómetro

Thermomèret · Thermometer
Thermometer · Termómetro

Ref	€	Temp.	U.Venta
A 62454	9,70	50°C (122°F)/300°C (572°F)	1
B 62450	7,60	-30°C (-22°F)/30°C (86°F)	1
C 62452	8,20	-54°C (129°F)/88°C (190°F)	1



Termómetro digital

Thermomètre numérique · Digital Thermometer
Digital thermometer · Termómetro Digita

Ref	€	L (cm)	Temp.	U.Venta
A 62487	29,80	23	0°C (-32°F)/300°C (572°F)	1
B 62453	20,60	15	-40°C (-40°F)/150°C (302°F)	1



Termómetro electrónico

Thermomètre Electronique · Electric Thermometer
Thermometer, Elektronisch · Termómetro Electrónico

Ref	€	Temp.	U.Venta
62459	20,70	-40°C (-40°F)/150°C (302°F)	1



Termómetro digital horno

Thermomètre numérique pour le four · Digitaler Ofen-Thermometer
Oven digital thermometer · Termómetro digital forno

Ref	€	cm	Temp.	U.Venta
62498	49,50	12x7,5	0°C (-32°F)/300°C (572°F)	1

La lente debería mantenerse limpia en todo momento
The lens should be kept clean at all times



NUNCA APUNTE CON EL DISPOSITIVO
LOS OJOS DE ALGUIEN
He jamais pointer l'instrument vers les yeux de quelqu'un
Never point the device towards anyone's eyes



Termómetro infrarrojos LASER

Therm. mesure de surface par infra rouge · Infrarot Thermometer
Infrared thermometer · Termómetro infravermelhos

Ref	€	Temp.	U.Venta
62457	122,80	-50°C (-58°F)/400°C (752°F)	1



Protector de plástico
Plastic protector



Termómetro de leche

Thermomètre à lait · Milch Thermometer
Milk thermometer · Termómetro de leite

Ref	€	L (cm)	T°	Unidad	U.Venta
62532	11,80	26,5	-10°C/110°C	°C	1

IP65 12/24 Horas



Magnético
Magnet

Reloj de cocina con alarma

Minuteur de Cuisine avec Alarme · Küchen-Zeitschaltuhr mit Alarm
Kitchen Timer Alarm · Relógio de cozinha com alarme

Ref	€	cm	U.Venta
60804	38,90	13x24,5x2,5	1



Magnético
Magnet

Reloj digital de cocina con avisador acústico

Minuter Électronique · Digitale Küchen-Zeitschaltuhr mit Alarm
Digital kitchen timer w/alarm · Relógio digital de cozinha com alarme acústico

Ref	€	cm	U.Venta
60805	9,00	10,5x7	1

Doble pantalla
para nevera y congelador
Double screen
for fridge and freezer



Base magnética
Magnetic base



Termómetro para nevera/congelador

Thermomètre de réfrigérateur/congérateur · Thermometer f/Kühlschrank/Gefrierfach
Fridge/Freezer thermometer · Termómetro para refrigerador/congelador

Ref	€	Temp.	Temp.	U.Venta
62456	37,70	0°C (-32°F)/70°C (572°F)	0°C (-572°F)/-40°C (-32°F)	1



Clip de sujeción (cacerolas)
y bola de madera para un fácil manejo
Hanging clip (casseroles) and
wooden ball for easy handling



Funda de protección incluida
Protective cover included

Termómetro de azúcar

Thermomètre à sucre · Zuckerthermometer
Sugar thermometer · Termómetro de açúcar

Ref	€	L (cm)	T°	Unidades	U.Venta
62533	5,10	21,5	200°C (400°F)	°C / °F	12

La lente debería mantenerse limpia en todo momento
The lens should be kept clean at all times

Termómetro DUAL

Thermomèret · Thermometer
Thermometer · Termómetro

Ref	€	Temp.	Sonda	U.Venta
62458	103,70	-40°C (-40°F)/230°C (302°F)	-33°C (-27°F)/220°C (428°F)	1



2 in 1

Si
Siliconia

Inox

Termómetro sonda

Thermometre sonde · Thermometer/Sonde
Thermometer probe · Termómetro sonda

Ref	€	Temp.	L (cm)	U.Venta
62500	16,00	-50°C (-64°F)/300°C (572°F)	25	1
62528	17,20	-50°C (-64°F)/300°C (572°F)	25	1



Magnético
Magnet

Reloj de cocina magnético

Minuteur de cuisine magnetique · Magnetküchentimer
Magnetic kitchen timer · Relógio de cozinha magnetico

Ref	€	Tiempo	cm	U.Venta
60803	10,80	60 min	9,2x3,5	1

24 Horas



Soporte plegable. Potente imán
Folding stand. Powerful magnet

Reloj de cocina con alarma

Minuteur de Cuisine avec Alarme · Küchen-Zeitschaltuhr mit Alarm
Kitchen Timer Alarm · Relógio de cozinha com alarme

Ref	€	cm	U.Venta
60802	19,60	7x1,4x5,1	1

INOX

Bandejs · Platos



ES

- Para uso profesional o doméstico.
- Fabricadas en acero inoxidable de alta calidad.
- Excelente resistencia a la corrosión.
- Ideales para servir o presentar todo tipo de comidas en buffets, restaurantes o en casa.

FR

- Pour un usage professionnel ou domestique.
- Fabriqués en acier inoxydable de grande qualité.
- Excellente résistance à la corrosion.
- Parfaits pour servir ou présenter tout type d'aliments dans des buffets, des restaurants ou à la maison.

EN

- For professional or home use.
- Made from high-quality stainless steel.
- Extremely resistant to corrosion.
- Ideal for serving and presenting all types of food in buffets, restaurants, or even at home.



Plegable (7 cm)
Collapsible (7 cm)



Soporte para bandejas
Support pour plateaux · Tablethalter
Tray stand · Suporte para bandejas

Ref	€	cm	h (cm)	U.Venta
61870	68,00	41,5x52	80	1

Bandejas redondas, ovales, cuadradas, rectangulares, etc.
It can be used with round, oval, square, rectangular trays...

- Soporte fabricado en acero inoxidable de máxima calidad.
- Diseñado para apoyar bandejas de gran tamaño en servicio de sala.
- Barras tubulares y soportes cruzados para una mayor resistencia y estabilidad.
- 100% seguro: 8 arandelas ajustables y pies antideslizantes para que las bandejas no resbalen en ningún momento.
- Plegable; facilita el traslado y el almacenaje.
- Support fabriqué en acier inoxydable de la plus grande qualité.
- Conçu pour y poser des plateaux de grande taille lors du service en salle.
- Barres tubulaires et supports croisés pour une plus grande résistance et stabilité.
- 100% sûr : 8 rondelles réglables et pieds antidérapants pour que les plateaux ne glissent pas.
- Pliable ; facilite le transport et le rangement.
- Stand made of top-quality stainless steel.
- Specially designed to support large trays when serving food.
- Tubular bars and cross supports for extra strength and stability.
- 100% safe: 8 adjustable washers and non-slip feet to prevent the trays from slipping at any moment.
- Collapsible, easy to carry and store.



Fuente oval

Plat ovale · Buffet-Tablett, oval
Oval dish · Travessa oval

Ref	€	cm	U.Venta
61820	5,90	20x13	1
61825	8,30	25x17	1
61830	9,10	30x20	1
61835	11,30	35x23	1
61840	13,60	40x26	1
61845	15,90	45x29	1
61850	19,50	50x31	1
61871	45,20	70x45	1
61881	52,80	80x48	1

Inox 18/10



Fuente oval pulido satinado

Plat ovale poli-satine · Buffet-Tablett, oval
Oval dish satin polish · Travessa oval pulido mate

Ref	€	cm	U.Venta
62820	8,60	20x13	1
62825	10,90	25x17	1
62830	13,60	30x20	1
62835	16,80	35x23	1
62840	22,10	40x26	1
62845	25,00	45x29	1
62850	30,10	50x31	1



Fuente redonda

Plat rond 3 Bratenplatte, rund
Round serving dish · Travessa redonda

Ref	€	Ø (cm)	U.Venta
61831	11,00	30	6
61836	13,70	35	6



Fuente de pescado

Plat à poisson · Fischplatte
Fish tray · Travessa peixe

Ref	€	cm	U.Venta
61860	28,10	60x27	1
61880	35,60	80x30	1



Fuente honda oval

Plat à gratin ovale · Schale, oval
Deep oval dish · Travessa funda oval

Ref	€	cm	h (cm)	U.Venta
61828	13,70	30x20	4,5	1
61832	16,70	35x24	4,5	1
61838	20,60	40x26	4,5	1
61843	22,20	45x29	4,5	1
61848	26,50	50x31	4,7	1



Bandeja octogonal

Plateau octogona · Platte, achteckig
Octogonal tray · Bandeja octogonal

Ref	€	cm	U.Venta
65031	54,70	31x24	1
65037	66,30	37x27	1
65041	116,20	41x32	1
65046	152,70	46x36	1

New

AL
Aluminium



Bandeja MASTER

Plateau · Platte
Tray · Bandeja

Ref	€	cm	h (cm)	U.Venta
A 68465	23,10	45x33	5,0	1
B 68466	24,10	53x38	2,5	1

- Calidad premium: Fabricada en aluminio natural; 99,5% de pureza.
- Garantiza una conductividad térmica superior, con una distribución homogénea del calor permitiendo así que todas las elaboraciones se doren y se horneen de forma uniforme.
- Especialmente diseñadas para profesionales de la repostería, cocinas exigentes y de alta producción.
- Ligera, resistente e indeformable, fácil manejo.
- Limpieza: Se recomienda lavarla a mano con un jabón y una esponja no abrasivos. No apto para el lavavajillas.
- Consejos de uso: se recomienda usar tanto papel / tapete para hornear.

- Qualité premium : Fabriqué en aluminium naturel ; 99,5% de pureté.
- Garantit une conductivité thermique supérieure avec une distribution homogène de la chaleur, permettant ainsi à toutes les préparations culinaires de dorer et cuire de façon uniforme.
- Spécialement conçu pour les professionnels de la pâtisserie, les cuisines exigeantes et de grande production.
- Léger, résistant et indéformable ; facile à manipuler.
- Nettoyage : il est recommandé de le laver à la main avec du savon et une éponge non abrasifs. Ne peut pas aller au lave-vaisselle.
- Conseils d'utilisation : il est recommandé d'utiliser du papier sulfurisé ou un tapis de cuisson pour cuire les aliments.

- Premium quality: made from 99.5% pure natural aluminium.
- Guarantees excellent thermal conductivity and homogeneous heat distribution, allowing all baked goods to brown and bake evenly.
- Specially designed for professional bakers, demanding chefs and busy, high output kitchens.
- Lightweight, robust, non-deformable and easy to handle.
- Cleaning: cleaning by hand with detergent and a non-abrasive sponge is recommended. Not dishwasher safe.
- Instructions for use: baking mats and baking paper are both recommended.

garinox®



Bandeja de marisco

Plateau a fruit de mer · Platte für Seemuschel
Sea food tray · Bandeja de mariscos

Ref	€	Ø (cm)	U.Venta
14027	9,70	28	6
14042	21,60	42	1
14050	33,80	50	6



Soporte para bandeja de mariscos

Support pour plateau a fruit de mer · Ständer für Seemuschelplatte,
Stand for sea food tray · Suporte para bandeja de mariscos

Ref	€	Ø Sup. (cm)	Ø Inf. (cm)	h (cm)	U.Venta
14100	14,60	24,5	19	20	1



Bandeja camarero

Plateau limonadier · Serviertablett, rund
Serving tray · Bandeja de servir

Ref	€	Ø (cm)	U.Venta
61841	21,00	40	1



Bandeja camarero pulido satinado

Plateau limonadier poli-satine · Serviertablett, rund
Serving tray satin polish · Bandeja de servir pulido mate

Ref	€	Ø (cm)	U.Venta
62841	27,90	40	1



Bandeja camarero

Plateau limonadier · Serviertablett
Serving tray · Bandeja de servir

Ref	€	Ø (cm)	U.Venta
14135	10,10	32	6
14136	11,70	36	1
14145	19,80	45	1



Plato de huevos

Plat à oeufs · Eiteller
Egg serving dish · Prato de ovos

Ref	€	Ø (cm)	h (cm)	U.Venta
61116	5,10	16	3	6



Bandeja con pinza para notas

Porte addition á pince · Platte mit Klemmvorrichtung
Bill holder · Bandeja com pinça para notas

Ref	€	cm	U.Venta
A 68007	5,30	11x15,2	12
B 68017	6,20	12x21,5	12



Bandeja cambios COIN

Coupelle ramasse monnaie · Wechselgeldablagen
Changetray · Bandeja para trocos

Ref	€	Ø (cm)	U.Venta
68720	3,10	13	12



Plato camping

Plate de camping · Campingplatte
Camping dinner plate · Prato camping

Ref	€	Ø (cm)	U.Venta
A 61121	7,00	22	1
B 61122	7,40	22	6



Posabotellas

Dessous de bouteille · Flaschenuntersetzer
Bottle stand · Pousa-garrafas

Ref	€	Ø (cm)	U.Venta
61113	3,80	13	6



Posavasos

Sous-verre · Glasuntersetzer
Glass stand · Pousa-copos

Ref	€	Ø (cm)	U.Venta
61110	3,20	10,5	6

PIZARRA

Bandejas



ES

- Totalmente artesanales, cada bandeja es única e irrepetible.
- Ideal para la presentación de platos fríos y calientes.
- Ofrecen un aire de modernidad, elegancia y sencillez.
- Excelente conductor del frío y del calor.
- Evita los cambios bruscos de temperatura para su conservación.
- Contienen tacos antideslizantes para asegurar su estabilidad.
- NOTA: para conservarlas brillantes y con su color natural, cada ciertos usos impregnarlas con aceite de oliva virgen extra por ambas caras y cantos.

FR

- Totalement artisanaux, chaque plateau étant unique et inimitable.
- Idéal pour la présentation de plats froids et chauds.
- Ils apportent un air de modernité, d'élégance et de simplicité.
- Excellent conducteur du froid et de la chaleur.
- Évite les changements de température brusques pour leur conservation.
- Possèdent des taquets antidérapants pour assurer leur stabilité.
- REMARQUE : pour conserver leur brillance et leur couleur naturelle, il faut les imprégner régulièrement d'huile d'olive vierge sur les deux côtés et sur les bords.

EN

- Entirely handmade, every tray is unique and unreproducible.
- Perfect for presenting hot and cold dishes.
- They have an air of modernity, elegance and simplicity.
- Excellent conductor of heat and cold.
- Avoid abrupt temperature changes to prevent damage.
- They have anti-slip feet to ensure stability.
- NOTE: after every few uses, wipe the edges and both faces thoroughly with extra virgin olive oil to preserve their brightness and natural colour.



Bandeja redonda

Plateau rond · Serviertablett rund
Round tray · Bandeja redonda

Ref	€	Ø (cm)	e (mm)	U.Venta
61070	3,50	20	5	6
61071	5,00	25	5	6
61072	6,90	30	5	6
61073	9,70	35	5	4
61078	9,80	40	5	4



Bandeja cuadrada

Plateau carré · Serviertablett, viereckig
Square tray · Bandeja quadrada

Ref	€	cm	e (mm)	U.Venta
61010	3,00	10x10	5	32
61015	4,40	15x15	5	32
61019	5,10	20x20	5	24
61044	16,00	40x40	5	8



Bandeja rectangular

Plateau rectangulare · Serviertablett, rechteckig
Rectangular tray · Bandeja rectangular

Ref	€	cm	e (mm)	U.Venta
61016	4,20	10x15	5	48
61021	4,90	15x20	5	24
61029	6,10	15x30	5	18
61031	7,70	20x30	5	12
61041	9,00	20x40	5	12
61051	12,70	20x50	5	8
61043	14,00	40x30	5	8
61064	28,50	60x40	5	3

New

FIBREGLASS

Bandejas



ES

- Para uso profesional.
- Fabricadas en fibra de vidrio.
- Superficie antiadherente y antideslizante.
- Indeformables y muy ligeras.

FR

- Pour un usage professionnel.
- Fabriqué en fibre de verre.
- Surface antiadhésive et antidérapante.
- Indéformable et très légères.

EN

- For professional use.
- Made of fiberglass.
- Non-stick and non-slip surface.
- Undeformable and very light.



Bandeja redonda

Plateau rond · Serviertablett rund
Round tray · Bandeja redonda

Ref	€	Ø (cm)	U.Venta
69136	14,10	36	1
69140	20,90	40	1



Bandeja rectangular

Plateau rectangulare · Serviertablett, rechteckig
Rectangular tray · Bandeja rectangular

Ref	€	cm	U.Venta
69146	24,50	36x46	1
69152	29,50	38x52	1
69156	37,50	40x56	6
69165	53,90	45x65	6



Bandeja oval

Plateau ovale · Oval Serviertablett
Oval tray · Bandeja oval

Ref	€	cm	U.Venta
69168	64,20	56x68	6

Melamina
Melamine



EARTH

Colección



ES

- Fabricadas en melamina de alta calidad. Libre de BPA.
- Una completa gama que ofrece un aspecto rústico, con piezas únicas y elegantes.
- Diseñadas para realizar las creaciones del chef.
- Ligeras, resistentes a golpes y choques térmicos.
- Higiénicas y fácilmente lavables, aptas para lavavajillas.

FR

- Produits fabriqués en mélamine de grande qualité. Sans BPA.
- Une gamme complète qui offre un aspect rustique, avec des pièces uniques et élégantes.
- Conçus pour réaliser les créations du chef.
- Légers, résistants aux chocs et aux variations thermiques.
- Hygiéniques et faciles à laver, aptes pour le lave-vaisselle.

EN

- Made of high quality melamine. BPA free.
- A full range with unique and elegant pieces and a rustic look.
- Designed to highlight the chef's creations.
- Lightweight and resistant to impacts and thermal shock.
- Hygienic, easy to wash and dishwasher safe.



Fuente rectangular

Plateau rectangulaire · Serviertablet, rechteckig
Rectangular tray · Travessa rectangular

Ref	€	cm	h (cm)	U.Venta
63830	8,20	18,6x13,5	2,7	1



Fuente rectangular

Plateau rectangulaire · Serviertablet, rechteckig
Rectangular tray · Travessa rectangular

Ref	€	cm	h (cm)	U.Venta
63831	10,10	21,7x13,6	3,1	1
63832	12,40	25,2x17,2	3,6	1
63834	20,80	30,8x21,6	3,5	1
63855	28,50	35x23,8	4,1	1



Fuente rectangular

Plateau rectangulaire · Serviertablet, rechteckig
Rectangular tray · Travessa rectangular

Ref	€	cm	h (cm)	U.Venta
63833	11,40	28,6x12,7	3,4	1



Fuente rectangular ondulada

Plateau rectang. ondulé · Serviertablet, rechteckig, gewellt
Rectangular undulated tray · Travessa rectang. ondulada

Ref	€	cm	h (cm)	U.Venta
63865	18,40	29x17,5	3,0	1



Fuente oval

Plateau oval · Oval platte
Oval tray · Travessa redonda

Ref	€	cm	h (cm)	U.Venta
63863	9,50	25,4x13	2,9	1



Fuente lágrima

Plateau larme · Träne platte
Tear tray · Travessa lágrima

Ref	€	cm	h (cm)	U.Venta
63854	16,70	28,2x21,4	4,8	1



Fuente oval

Plateau oval · Oval platte
Oval tray · Travessa redonda

Ref	€	cm	h (cm)	U.Venta
63852	8,40	19,7x14,1	3,7	1
63853	11,50	22,5x16,4	4,4	1
63864	18,10	28,4x19	5,1	1



Plato redondo

Plateau rond · Rund Teller
Round plate · Prato redondo

Ref	€	Ø (cm)	h (cm)	U.Venta
63841	6,00	15,5	2,4	1
63842	9,00	19,4	2,9	1
63843	9,70	21,5	3,2	1
63844	15,30	24,2	3,5	1
63845	17,60	25,6	3,7	1



Plato hondo redondo

Plateau profonde ronde · Rund tiefe Platte
Round deep plate · Prato profundo redondo

Ref	€	Ø (cm)	h (cm)	U.Venta
63839	9,00	17,7	4,4	1
63840	18,90	24	5,5	1



Fuente cuadrada

Plateau carrée · Quadratischen platte
Square tray · Travessa quadrado

Ref	€	cm	h (cm)	U.Venta
63846	7,50	12x12	5,0	1
63847	15,80	19x19	6,0	1
63848	24,50	24x24	6,8	1



Bol salsa mini

Bol sauce mini · Boul sauce min
Sauce bowl mini · Bacia molho mini

Ref	€	cm	h (cm)	ml	U.Venta
63862	2,90	7,2x7,2	3,0	30	1



Bol

Bol · Boul
Bowl · Bacia

Ref	€	Ø (cm)	h (cm)	ml	U.Venta
63856	3,00	8,3	3,2	60	1
63857	4,80	9,5	4,6	130	1
63858	5,10	10,6	5,2	220	1
63859	7,00	12,6	6,0	300	1
63861	6,40	12,4	4,6	300	1



Bol oval

Bol oval · Oval bowl
Oval bowl · Bacia oval

Ref	€	cm	h (cm)	ml	U.Venta
63849	4,50	12x10	4,1	130	1
63860	7,80	16,3x12,3	4,7	220	1
63850	15,60	20,7x16,8	8,0	660	1
63851	24,30	24,2x20,6	9,3	1150	1



Bol cónico

Conique bol · Boul Konish
Conical bowl · Bacia cónica

Ref	€	Ø (cm)	h (cm)	ml	U.Venta
63835	8,80	15,7	5,9	330	1
63836	10,70	18,3	6,8	560	1
63837	14,10	21,3	7,8	750	1
63838	19,90	24,2	8,8	1350	1

SEA Colección



ES

- Fabricadas en melamina de alta calidad. Libre de BPA.
- Una completa gama que ofrece un aspecto rústico, con piezas únicas y elegantes.
- Diseñadas para realizar las creaciones del chef.
- Ligeras, resistentes a golpes y choques térmicos.
- Higiénicas y fácilmente lavables, aptas para lavavajillas.

FR

- Produits fabriqués en mélamine de grande qualité. Sans BPA.
- Une gamme complète qui offre un aspect rustique, avec des pièces uniques et élégantes.
- Conçus pour réaliser les créations du chef.
- Légers, résistants aux chocs et aux variations thermiques.
- Hygiéniques et faciles à laver, aptes pour le lave-vaisselle.

EN

- Made of high quality melamine. BPA free.
- A full range with unique and elegant pieces and a rustic look.
- Designed to highlight the chef's creations.
- Lightweight and resistant to impacts and thermal shock.
- Hygienic, easy to wash and dishwasher safe.



Fuente rectangular

Plateau rectangulaire · Serviertablet, rechteckig
Rectangular tray · Travessa rectangular

Ref	€	cm	h (cm)	U.Venta
63941	8,20	18,6x13,5	2,7	1



Fuente rectangular

Plateau rectangulaire · Serviertablet, rechteckig
Rectangular tray · Travessa rectangular

Ref	€	cm	h (cm)	U.Venta
63942	10,10	21,7x13,6	3,1	1
63943	12,40	25,2x17,2	3,6	1
63945	20,80	30,8x21,6	3,5	1
63966	28,50	35x23,8	4,1	1



Fuente rectangular

Plateau rectangulaire · Serviertablet, rechteckig
Rectangular tray · Travessa rectangular

Ref	€	cm	h (cm)	U.Venta
63944	11,40	28,6x12,7	3,4	1



Fuente rectangular ondulada

Plateau rectang. ondulé · Serviertablet, rechteckig, gewellt
Rectangular undulated tray · Travessa rectang. ondulada

Ref	€	cm	h (cm)	U.Venta
63976	18,40	29x17,5	3,0	1



Fuente oval

Plateau oval · Oval platte
Oval tray · Travessa redonda

Ref	€	cm	h (cm)	U.Venta
63974	9,50	25,4x13	2,9	1



Fuente lágrima

Plateau larme · Träne platte
Tear tray · Travessa lágrima

Ref	€	cm	h (cm)	U.Venta
63965	16,70	28,2x21,4	4,8	1



Fuente oval

Plateau oval · Oval platte
Oval tray · Travessa redonda

Ref	€	cm	h (cm)	U.Venta
63963	8,40	19,7x14,1	3,7	1
63964	11,50	22,5x16,4	4,4	1
63975	18,10	28,4x19	5,1	1



Plato redondo

Plateau rond · Rund Teller
Round plate · Prato redondo

Ref	€	Ø (cm)	h (cm)	U.Venta
63952	6,00	15,5	2,4	1
63953	9,00	19,4	2,9	1
63954	9,70	21,5	3,2	1
63955	15,30	24,2	3,5	1
63956	17,60	25,6	3,7	1



Plato hondo redondo

Plateau profonde ronde · Rund tiefe Platte
Round deep plate · Prato profundo redondo

Ref	€	Ø (cm)	h (cm)	U.Venta
63950	9,00	17,7	4,4	1
63951	18,90	24	5,5	1



Fuente cuadrada

Plateau carrée · Quadratischen platte
Square tray · Travessa quadrado

Ref	€	cm	h (cm)	U.Venta
63957	7,50	12x12	5,0	1
63958	15,80	19x19	6,0	1
63959	24,50	24x24	6,8	1



Bol salsa mini

Bol sauce mini · Boul sauce min
Sauce bowl mini · Bacia molho mini

Ref	€	cm	h (cm)	ml	U.Venta
63973	2,90	7,2x7,2	3,0	30	1



Bol

Bol · Boul
Bowl · Bacia

Ref	€	Ø (cm)	h (cm)	ml	U.Venta
63967	3,00	8,3	3,2	60	1
63968	4,80	9,5	4,6	130	1
63969	5,10	10,6	5,2	220	1
63970	7,00	12,6	6,0	300	1
63972	6,40	12,4	4,6	300	1



Bol oval

Bol oval · Oval bowl
Oval bowl · Bacia oval

Ref	€	cm	h (cm)	ml	U.Venta
63960	4,50	12x10	4,1	130	1
63971	7,80	16,3x12,3	4,7	220	1
63961	15,60	20,7x16,8	8,0	660	1
63962	24,30	24,2x20,6	9,3	1150	1



Bol cónico

Conique bol · Boul Konish
Conical bowl · Bacia cónica

Ref	€	Ø (cm)	h (cm)	ml	U.Venta
63946	8,80	15,7	5,9	330	1
63947	10,70	18,3	6,8	560	1
63948	14,10	21,3	7,8	750	1
63949	19,90	24,2	8,8	1350	1

CLASSIC

Colección



ES

· Una completa gama contemporánea en blanco y negro.
· Diseñadas para realizar las creaciones del chef.

FR

· Une gamme complète contemporaine en noir et blanc.
· Conçues pour rehausser les créations du chef.

EN

· Wide collection contemporary black and white pieces.
· Designed to complete the chef's creations.

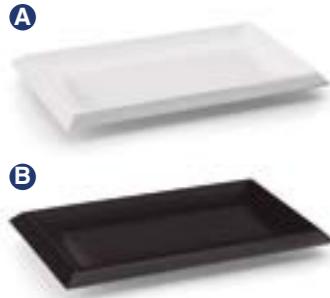

Bandeja rectangular

Plateau rectangulaire · Serviertablet, rechteckig
Rectangular tray · Bandeja rectangular

	Ref	€	cm	h (cm)	U.Venta
A	63531	8,60	26x16	2	6
	63532	14,40	30x22	2	6
B	63541	8,60	26x16	2	6
	63542	14,40	30x22	2	6



Bandeja rectangular

Plateau rectangulaire · Serviertablet, rechteckig
Rectangular tray · Bandeja rectangular

	Ref	€	cm	h (cm)	U.Venta
A	63535	37,30	53x32	3	6
	63536	54,20	70x30	2	3
B	63545	37,70	53x32	3	6
	63546	54,20	70x30	2	3

Fuente oval

Plateau oval · Oval platte
Oval tray · Travessa redonda

	Ref	€	cm	h (cm)	L	U.Venta
A	63557	9,70	32x12	6	0,85	6
	63558	15,50	41,5x17	8	2,20	6
B	63567	9,70	32x12	6	0,85	6
	63568	15,50	41,5x17	8	2,20	6



Bandeja rectangular

Plateau rectangulaire · Serviertablet, rechteckig
Rectangular tray · Bandeja rectangular

	Ref	€	cm	h (cm)	U.Venta
A	63533	18,60	30x21	3	6
	63534	22,00	35x21	2	6
B	63543	18,60	30x21	3	6
	63544	22,70	35x21	2	6



Fuente pescado

Plateau poisson · Fischplatte
Fish tray · Travessa peixe

	Ref	€	cm	h (cm)	U.Venta
A	63589	30,50	57x22	4	1
B	63599	30,50	57x22	4	1



Bandeja delicatessen

Plateau delicatessen · Schüssel delicatessen
Delicatessen tray · Bandeja delicatessen

	Ref	€	cm	U.Venta
A	63609	3,50	9,5x9,5	6
B	63619	3,50	9,5x9,5	6



Fuente redonda WHITE

Plateau rond · Rundplatte
Round tray · Travessa redonda

	Ref	€	Ø (cm)	h (cm)	U.Venta
	63551	28,90	40,0	6,0	6
	63552	38,40	44,5	6,5	1



Fuente WHITE

Plateau · Serviertablet
Tray · Travessa

	Ref	€	Ø (cm)	h (cm)	L	U.Venta
	63577	26,60	35,5	11	4,0	6



Bol redondo WHITE

Bol rond · Schale rund
Round bowl · Bacia redonda

	Ref	€	Ø (cm)	h (cm)	L	U.Venta
	63553	15,80	22	10,0	2,4	6
	63554	23,40	28	10,0	4,0	6
	63555	32,50	33	13,0	7,0	6
	63556	40,40	38	14,5	11,0	2



Bandeja delicatessen

Plateau delicatessen · Schüssel delicatessen
Delicatessen tray · Bandeja delicatessen

	Ref	€	cm	h (cm)	L	U.Venta
A	63610	3,00	10x10	2,5	0,12	6
B	63617	3,00	10x10	2,5	0,12	6



Fuente cuadrada WHITE

Plateau rectangulaire · Serviertablet, rechteckig
Rectangular tray · Travessa quadrada

	Ref	€	cm	h (cm)	L	U.Venta
	63573	28,20	33,5x33,5	8,5	5,0	1



Portatartas

Guéridon pâtisserie · Kuchenplatte
Cake stand · Porta-tartes

	Ref	€	Ø (cm)	h (cm)	U.Venta
	63586	32,50	33	9	4



Bol oval WHITE

Bol oval · Schale oval
Oval bowl · Bacia oval

	Ref	€	cm	h (cm)	L	U.Venta
	63585	23,70	29x26	16	4,0	6



Ribbed bol

Ribbed bol · Schale gerippt
Bowl Ribbed · Bacia Ribbed

	Ref	€	Ø (cm)	h (cm)	L	U.Venta
	63611	2,40	7,0	3	0,05	6
	63612	2,80	8,5	4	0,10	6



Bol ensalada

Bac salade · Schüssel
Salad bowl · Bacia de salada

Ref	€	cm	h (cm)	L	U.Venta
63570	7,90	13x13	6	0,5	6
63571	19,80	19x19	9	2,0	1
63572	38,60	25x25	12	4,8	1
63580	7,90	13x13	6	0,5	6
63581	19,80	19x19	9	2,0	1
63582	38,60	25x25	12	4,8	1



Bandeja oval

Plateau ovale · Serviertablett oval
Oval tray · Bandeja oval

Ref	€	cm	h (cm)	U.Venta
62751	4,20	20,7x14,4	1,8	10
62753	6,20	25,0x18,3	2,2	10
62754	6,80	28,0x20,0	2,4	10
62755	8,00	31,4x23,4	2,5	10
62756	10,10	33,5x25,8	2,6	10
62757	11,20	32,6x28,5	2,7	10
62759	16,50	45,8x34,8	3,0	10



Bandeja redonda

Plateau rond · Serviertablett rund
Round tray · Bandeja redonda

Ref	€	Ø (cm)	h (cm)	U.Venta
62761	4,30	18,0	2,4	10
62762	5,10	20,0	2,5	10
62764	7,40	25,4	2,9	10
62766	12,20	30,7	3,3	10
62768	14,60	33,5	3,2	10
62769	21,00	40,0	3,5	6



Plato redondo ondulado

Plateau rond ondulé · Rund Teller gewellt
Undulated round plate · Prato redondo ondulado

Ref	€	Ø (cm)	h (cm)	U.Venta
62770	6,40	20,7	2,8	10
62771	10,70	25,0	3,0	1
62772	12,50	29,5	3,1	1



Bandeja rectangular

Plateau rectangulaire · Serviertablett, rechteckig
Rectangular tray · Bandeja rectangular

Ref	€	cm	h (cm)	U.Venta
62791	7,30	24,8x16,0	2,3	10
62792	10,60	28,0x19,0	2,3	10
62793	12,20	30,0x20,8	2,3	10



Bol redondo

Bac rond · Schüssel, rund
Round bowl · Bacia refondo

Ref	€	Ø (cm)	h (cm)	L	U.Venta
62785	3,70	11,8	5,1	0,30	10
62786	4,40	12,8	5,7	0,40	10
62787	5,20	14,9	6,5	0,60	10



Bol cuadrado

Bac carre · Schüssel, viereckig
Square bowl · Bacia quadrada

Ref	€	cm	h (cm)	L	U.Venta
62780	4,20	12,3x12,3	6,3	0,40	10
62781	4,90	14,9x14,9	7,0	0,70	10
62782	6,10	17,3x17,3	7,9	1,00	10
62783	8,00	19,7x19,7	8,8	1,50	1
62784	10,60	21,5x21,5	9,5	2,00	1



Cuchara lisa

Cuillère lisse · ServierLöffel
Plain spoon · Colher lisa

Ref	€	L (cm)	U.Venta
63600	1,00	18	6



Cacillo

Louche · Schöpfkelle
Soup ladle · Concha

Ref	€	L (cm)	ml	U.Venta
63602	2,90	27	150	6
63605	2,90	27	-	6



Cuchara

Cuillère · Löffel
Spoon · Colher

Ref	€	L (cm)	ml	U.Venta
63601	1,80	25	40	6
63604	2,50	30	50	6
63603	2,40	30	-	6

FUJI Colección



ES

· Inspiradas en la cocina oriental.
· La armonía entre el Ying y el Yang constituyen el diseño exclusivo de la gama Fuji.

FR

· Inspirées de la cuisine orientale.
· L'harmonie du Ying et du Yang constitue le style exclusif de la gamme Fuji.

EN

· Inspired by oriental cuisine.
· The harmony between Ying and Yang forms the exclusive design of the Fuji range.



Fuente cuadrada

Plateau rectangulaire · Serviertablett, rechteckig
Rectangular tray · Travessa quadrada

Ref	€	cm	h (cm)	U.Venta
63161	15,60	22x22	2,5	6
63162	18,20	27,5x27,5	3,0	6



Bandeja rectangular

Plateau rectangulaire · Serviertablett, rechteckig
Rectangular tray · Bandeja rectangular

Ref	€	cm	h (cm)	U.Venta
63163	14,50	29x18	3	6



Bandeja rectangular

Plateau rectangulaire · Serviertablett, rechteckig
Rectangular tray · Bandeja rectangular

Ref	€	cm	h (cm)	U.Venta
63164	21,50	34x21,5	2,5	6



Bandeja rectangular

Plateau rectangulaire · Serviertablett, rechteckig
Rectangular tray · Bandeja rectangular

Ref	€	cm	h (cm)	U.Venta
63165	13,60	25x15	3	6



Fuente oval

Carrée ovale · Schale oval
Oval tray · Travessa oval

Ref	€	cm	h (cm)	L	U.Venta
63166	14,70	25x19	5	0,6	6



Fuente lagrima

Plat feuille · Platte, Träne
Tear plate · Travessa lagrima

Ref	€	cm	h (cm)	U.Venta
63175	15,10	34x13	3	6



Fuente hoja

Palt feuille · Platte, Bratt
Leaf plate · Travessa folha

Ref	€	cm	h (cm)	U.Venta
63176	15,30	37,5x16	4,0	6
63177	22,40	46,5x21	6,5	6



Cuchara snack

Cuillère snack · Löffel snack
Snack spoon · Colher snack

Ref	€	cm	h (cm)	U.Venta
63178	4,40	14,5x14,5	4,5	6



Bol oval

Ovale bol · Schale oval
Oval tray · Bacia oval

Ref	€	cm	h (cm)	U.Venta
63173	6,80	14x8	4	6
63174	7,20	15x10	4	6



Bol

Bol · Schale
Bowl · Bacia

Ref	€	Ø (cm)	h (cm)	L	U.Venta
63169	24,30	26	8	2,2	6



Bol oval

Ovale bol · Schale oval
Oval tray · Bacia oval

Ref	€	cm	h (cm)	L	U.Venta
63171	9,70	18x13,5	6	0,5	6
63172	15,60	24x17,5	6	1,0	6

WHITE & BLACK

Colección



ES

- Combina formas suaves y orgánicas con un diseño puro y elegante.
- Piezas en color blanco y negro, únicas y elegantes

FR

- Allie des formes douces et organiques à un style pur et élégant.
- Pièces de couleur noire et blanche, uniques et élégantes.

EN

- Soft and organic forms are combined with pure, stylish design.
- Unique and elegant white and black pieces.



Bol cónico

Conique bol · Schale konisch
Conical bowl · Bacia cónica

	Ref	€	Ø (cm)	h (cm)	L	U.Venta
	63261	9,60	17	7,0	0,70	6
A	63262	11,50	21	8,0	1,25	6
	63263	13,10	25	8,5	1,80	6
	63361	9,60	17	7,0	0,70	6
B	63362	11,50	21	8,0	1,25	6
	63363	13,10	25	8,5	1,80	6



Bol oval

Bol oval · Oval bowl
Oval bowl · Bacia ova

	Ref	€	cm	h (cm)	L	U.Venta
	63268	7,80	17x14	6	0,40	6
A	63269	17,50	24x20	9	1,70	6
	63368	7,80	17x14	6	0,40	6
B	63369	17,50	24x20	9	1,70	6

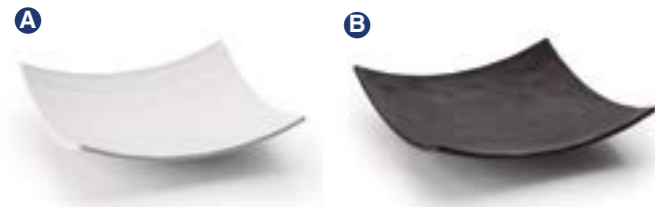

Fuente cuadrada

Plateau carrée · Quadratischen platte
Square tray · Travessa quadrado

	Ref	€	cm	h (cm)	U.Venta
	63272	7,40	19x19	4	6
A	63273	15,90	25x25	5	6
	63372	7,40	19x19	4	6
B	63373	15,90	25x25	5	6



Bol redondo

Rond bol · Schale rund
Bowl round · Bacia redonda

	Ref	€	Ø (cm)	h (cm)	L	U.Venta
	63264	7,60	12,5	7,5	0,45	6
A	63265	8,80	14,0	7,5	0,60	6
	63364	7,60	12,5	7,5	0,45	6
B	63365	8,80	14,0	7,5	0,60	6



Fuente redonda

Plateau rond · Rundplatte
Round tray · Travessa redonda

	Ref	€	Ø (cm)	h (cm)	L	U.Venta
A	63267	29,80	31	8	3,0	6
B	63367	29,80	31	8	3,0	6



Fuente rectangular

Plateau rectangulaire · Serviertablet, rechteckig
Rectangular tray · Travessa rectangular

	Ref	€	cm	h (cm)	U.Venta
A	63274	9,60	25x17,5	3	6
B	63374	9,60	25x17,5	3	6



Fuente oval

Plateau ovale · Schale oval
Oval tray · Travessa oval

	Ref	€	cm	h (cm)	U.Venta
	63275	13,30	32x14	4	6
A	63375	13,30	32x14	4	6



Fuente salsa mini

Plateau sauce mini · Serviertablet sauce mini
Sauce tray mini · Travessa molho mini

	Ref	€	cm	h (cm)	U.Venta
	63279	4,00	9x7	3	6
A	63379	4,00	9x7	3	6



Bol salsa

Bac sauce · Schüssel saucen
Sauce bowl · Bacia molho

	Ref	€	cm	h (cm)	L	U.Venta
	63270	5,90	14x12	5	0,25	6
A	63370	5,90	14x12	5	0,25	6



Vaso

Timbale · Trinkbecher
Tumbler · Copo

	Ref	€	Ø (cm)	h (cm)	L	U.Venta
	63350	3,40	7,3	7,7	0,32	1
A	63351	3,40	7,3	7,7	0,32	1



Fuente 3 salsas

Plateau 3 sauces · Serviertablet 3 sauces
3 sauces tray · Travessa 3 molhos

	Ref	€	cm	h (cm)	U.Venta
	63280	5,50	19x8	3	6
A	63380	5,50	19x8	3	6

STONE Colección



ES

- Fabricadas en melamina de alta calidad. Libre de BPA.
- Combinan formas naturales con aspecto elegante parecido al mármol.
- Diseñadas para realzar las creaciones del chef.
- Ligeras, resistentes a golpes y choques térmicos.
- Higiénicas y fácilmente lavables, aptas para lavavajillas.

FR

- Produits fabriqués en mélamine de grande qualité. Sans BPA.
- Ils allient des formes naturelles à un aspect élégant semblable au marbre.
- Conçus pour réaliser les créations du chef.
- Légers, résistants aux chocs et aux variations thermiques.
- Hygiéniques et faciles à laver, aptes pour le lave-vaisselle.

EN

- Made of high quality melamine. BPA free.
- They combine natural forms with an elegant appearance that looks like marble.
- Designed to highlight the chef's creations.
- Lightweight and resistant to impacts and thermal shock.
- Hygienic, easy to wash and dishwasher safe.



Plato redondo

Plateau rond · Rund Plate
Round plate · Prato redondo

Ref	€	Ø (cm)	h (cm)	U.Venta
63180	35,00	35	3,0	1
63181	53,40	44	3,0	1
63182	80,00	55	3,0	1



Bandeja cuadrada

Plateau carrée · Quadratischen platte
Square tray · Travessa quadrado

Ref	€	cm	h (cm)	U.Venta
63187	25,30	28,5x28,5	0,9	1



Bandeja rectangular

Plateau rectangulaire · Serviertablet, rechteckig
Rectangular tray · Bandeja rectangular

Ref	€	cm	h (cm)	U.Venta
63188	30,50	35x28,5	0,9	1
63189	38,60	43x28,5	0,9	1
63190	57,10	53x32	0,9	1



Fuente huevo

Plat oeufs · Eier platte
Egg plate · Travessa ovo

Ref	€	cm	h (cm)	U.Venta
63184	34,20	40,7x30,5	4,3	1



Fuente hoja

Palt feuille · Bratt platte
Leaf plate · Travessa folha

Ref	€	cm	h (cm)	U.Venta
63191	21,40	40x25,3	4,3	1
63192	38,00	53x33	4,3	1



Fuente oval

Carrée ovale · Schale oval
Oval tray · Travessa oval

Ref	€	cm	h (cm)	U.Venta
63183	45,90	65x26	3,0	1



Tabla con mango

Planche avec manche · Servierbrett mit Griff
Board with grip · Tábua com mango

Ref	€	cm	h (cm)	U.Venta
63185	23,40	40x19,5	0,9	1
63186	32,10	46x25	0,9	1

MAGMA

Colección



ES

- Fabricadas en melamina de alta calidad.
- Libres de BPA.
- Ofrecen un aspecto muy natural parecido al hierro fundido.
- Ideales para servir y presentar los platos más exquisitos.

FR

- Fabriqué en mélamine de haute qualité.
- Sans BPA.
- Aspect très naturel, semblable à la fonte d'aluminium.
- Idéale pour servir et présenter les plats les plus exquis.

EN

- Made of high quality melamine.
- BPA free.
- Very natural appearance similar to cast iron.
- Perfect for serving and presenting the most exquisite dishes.



Cacerola redonda

Faitout rond · Rund Bratentopf
Round casserole · Caçarola redonda

Ref	€	Ø (cm)	U.Venta
63384	5,10	16	12
63385	6,20	18	12



Cacerola oval

Faitout ovale · Oval Bratentopf
Oval casserole · Caçarola roval

Ref	€	cm	U.Venta
63388	4,50	18x12	12
63389	5,80	21x15	12



Wok

Wok · Wok
Wok · Wok

Ref	€	Ø (cm)	U.Venta
63386	4,30	15	12
63387	5,90	18	12



Mini grill

Mini grill · Mini grill
Mini grill · Mini grill

Ref	€	cm	U.Venta
63382	7,40	13,5x13,5	6



Mini sartén

Mini pøele · Mini Pfanne
Mini frying pan · Mini sertã

Ref	€	Ø (cm)	U.Venta
63381	7,00	15	6



Mini sartén rectangular

Mini pøele rectangulare · Mini Pfanne, rechteckiger
Rectangular Mini frying pan · Mini sertã rectangular

Ref	€	cm	U.Venta
63383	5,10	17x11,5	12

MINI-COCOTTES

Colección



ES

- Fabricadas en melamina de alta calidad. Libres de BPA.
- Ofrecen un aspecto muy natural parecido al hierro fundido.
- Ideales para servir y presentar los platos más exquisitos.

FR

- Fabriqué en mélamine de haute qualité. Sans BPA.
- Aspect très naturel, semblable à la fonte d'aluminium.
- Idéale pour servir et présenter les plats les plus exquis.

EN

- Made of high quality melamine. BPA free.
- Very natural appearance similar to cast iron.
- Perfect for serving and presenting the most exquisite dishes.

Cacerola BLACK

Faitout · Bratentopf
Casserole · Caçarola

	Ref	€	Ø (cm)	h (cm)	ml	U.Venta
A	63390	4,40	9	4,5	150	1
B	63391	11,80	18x8,5	5,0	480	1
C	63392	11,10	10	4,5	210	1
	63393	20,10	14	6,5	640	1



Cacerola RED

Faitout · Bratentopf
Casserole · Caçarola

	Ref	€	Ø (cm)	h (cm)	ml	U.Venta
A	63394	4,40	9	4,5	150	1
B	63395	11,80	18x8,5	5,0	480	1
C	63396	11,10	10	4,5	210	1
	63397	20,10	14	6,5	640	1



Cacerola GREY

Faitout · Bratentopf
Casserole · Caçarola

	Ref	€	Ø (cm)	h (cm)	ml	U.Venta
A	63398	4,40	9	4,5	150	1
B	63399	11,80	18x8,5	5,0	480	1
C	63400	11,10	10	4,5	210	1
	63401	20,10	14	6,5	640	1



CUBETAS GN

Colección



ES

- Fabricadas en melamina de alta calidad.
- Libres de BPA.
- Ligeras, indeformables y apilables.
- Higiénicas y fácilmente lavables.
- Aptas para procesos de refrigeración, congelación o distribución de alimentos.

FR

- Fabriqué en mélamine de haute qualité.
- Sans BPA.
- Légères, indéformables et empilables.
- Hygiéniques et facilement lavables.
- Compatibles pour des processus de réfrigération, congélation ou distribution d'aliments.

EN

- Made of high quality melamine.
- BPA free.
- Light, non-deformable and stackable.
- Hygienic and easily washable.
- Suitable for refrigeration and freezing processes and food distribution

1/1
530 x 325 mm



Cubeta 1/1

Bac 1/1 · GN-Behälter 1/1
Container 1/1 · Caixa 1/1

	Ref	€	h (mm)	L	U.Venta
A	66165E	44,20	65	8,50	1
	66110E	50,30	100	13,30	1
B	66165J	47,00	65	8,50	1
	66110J	52,90	100	13,30	1

1/2
265 x 325 mm



Cubeta 1/2

Bac 1/2 · GN-Behälter 1/2
Container 1/2 · Caixa 1/2

	Ref	€	h (mm)	L	U.Venta
A	66265E	23,10	65	4,50	1
	66210E	25,60	100	8,00	1
B	66265J	24,10	65	4,50	1
	66210J	27,20	100	8,00	1

1/3
176 x 325 mm



Cubeta 1/3

Bac 1/3 · GN-Behälter 1/3
Container 1/3 · Caixa 1/3

	Ref	€	h (mm)	L	U.Venta
A	66365E	18,00	65	2,50	1
	66310E	20,00	100	3,80	1
B	66365J	19,30	65	2,50	1
	66310J	21,40	100	3,80	1

1/4
265 x 162 mm



Cubeta 1/4

Bac 1/4 · GN-Behälter 1/4
Container 1/4 · Caixa 1/4

	Ref	€	h (mm)	L	U.Venta
A	66465E	15,50	65	1,90	1
	66410E	17,40	100	2,50	1
B	66465J	16,50	65	1,90	1
	66410J	18,60	100	2,50	1

2/3
350 x 325 mm



Cubeta 2/3

Bac 2/3 · GN-Behälter 2/3
Container 2/3 · Caixa 2/3

	Ref	€	h (mm)	L	U.Venta
A	66565E	33,30	65	5,50	1
B	66565J	34,80	65	5,50	1

1/6
176 x 162 mm



Cubeta 1/6

Bac 1/6 · GN-Behälter 1/6
Container 1/6 · Caixa 1/6

	Ref	€	h (mm)	L	U.Venta
A	66665E	11,10	65	1,10	1
	66610E	12,40	100	1,60	1
B	66665J	11,80	65	1,10	1
	66610J	13,30	100	1,60	1

2/4
530 x 165 mm



Cubeta 2/4

Bac 2/4 · GN-Behälter 2/4
Container 2/4 · Caixa 2/4

	Ref	€	h (mm)	L	U.Venta
A	66765E	23,20	65	4,50	1
B	66765J	24,00	65	4,50	1

MANTELES DE MESA

Colección

Cuero 100% reciclado
Leather 100% Recycled

OEKO-TEX®
CONFIDENCE IN LEATHER
LEATHER STANDARD



Se pueden personalizar en seco
Can be customized in dry

ES

- Fabricados en cuero 100% reciclado.
- Espesor de 1,5 y 2,1 mm.
- Disponibles en tres formatos; cuadrado, redondo y forma oval.
- Resistentes a altas temperaturas y manchas.
- Aislantes del calor.
- Impermeables.
- Se limpian fácilmente con solución hidroalcohólica sin dañar el producto.
- Perfectos para vestir y proteger las mesas de restaurantes, cafeterías y hasta el propio hogar.

FR

- Fabriqués en cuir 100% recyclé.
- Épaisseur de 1,5 et 2,1 mm.
- Disponibles en trois formats : carrés, ronds et forme ovale.
- Résistants aux hautes températures et aux taches.
- Isolants de la chaleur.
- Imperméables.
- Se nettoient facilement avec un chiffon humide, du désinfectant, etc.
- Parfaits pour habiller et protéger les tables des restaurants, des cafétérias, et même pour un usage domestique.

EN

- Made of 100% recycled leather.
- 1.5 mm and 2.1 mm Thickness.
- Available in three formats: square, round and oval shaped.
- Resistant to high temperatures and stains. Heat insulating.
- Waterproof.
- Easy to clean with a damp cloth, disinfectant, etc.
- Perfect for decorating and protecting tables in restaurants, cafés and even at home.

A



B



C



D



Mantel individual rectangular

Nappe individuelle rectangulaire · Tischset, rechteckiger
Rectangular individual placemat · Toalhas de mesa individual rectangular

	Ref	€	cm	e (mm)	Color	U.Venta	
A	66831	19,40	45x30	1,5	Marrón · Brown	1	MILOS
B	66832	19,40	45x30	1,5	Antracita · Anthracite	1	CRETA
C	66833	20,10	45x30	2,1	Marrón granulado · Grained brown	1	RINIA
D	66834	20,10	45x30	2,1	Negro granulado · Grainy Black	1	COS

Servicio mesa
Table service

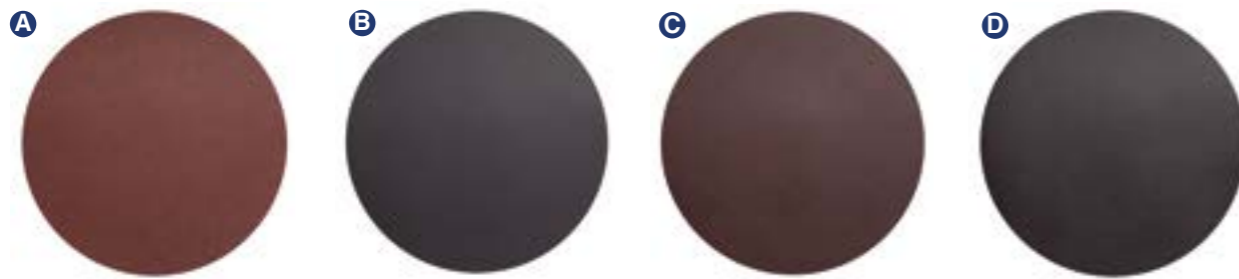

Mantel individual redondo

Nappe individual rond · Tischset, rund
Round individual placemat · Toalhas de mesa individual redondo

	Ref	€	Ø (cm)	e (mm)	Color	U.Venta
	66835	22,90	40	1,5	Marrón · Brown	1 MILOS
A	66836	22,90	40	1,5	Antracita · Anthracite	1 CRETA
B	66837	24,10	40	2,1	Marrón granulado · Grained brown	1 RINIA
C	66838	24,10	40	2,1	Negro granulado · Grainy Black	1 COS

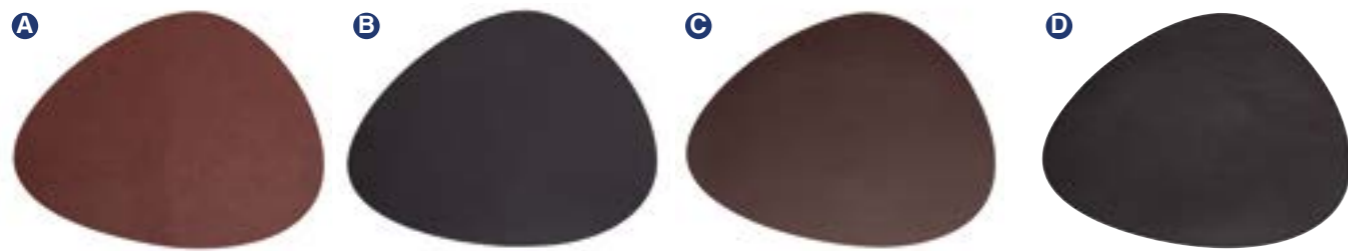

Mantel individual oval

Nappe individual ovale · Tischset, oval
Oval individual placemat · Toalhas de mesa individual oval

	Ref	€	cm	e (mm)	Color	U.Venta
	66839	21,00	45x35	1,5	Marrón · Brown	1 MILOS
A	66840	21,00	45x35	1,5	Antracita · Anthracite	1 CRETA
B	66841	22,00	45x35	2,1	Marrón granulado · Grained brown	1 RINIA
C	66842	22,00	45x35	2,1	Negro granulado · Grainy Black	1 COS



Fabricados en PVC 100%

Fait de 100% PVC / Hergestellt aus 100% PVC
Made of 100% PVC / Feita de 100% PVC

Mantel individual

Nappe individuel · Tischset
Individual placemat · Toalha de mesa individual

	Ref	€	cm	U.Venta
A	66784	6,90	45x30	6 MASBATE
B	66785	6,90	45x30	6 LEYTE



Fabricados en PVC 100%

Fait de 100% PVC / Hergestellt aus 100% PVC
Made of 100% PVC / Feita de 100% PVC

Mantel individual

Nappe individuel · Tischset
Individual placemat · Toalha de mesa individual

	Ref	€	cm	U.Venta
A	66787	6,90	45x30	6 DAVAO
B	66788	6,90	45x30	6 TICAO

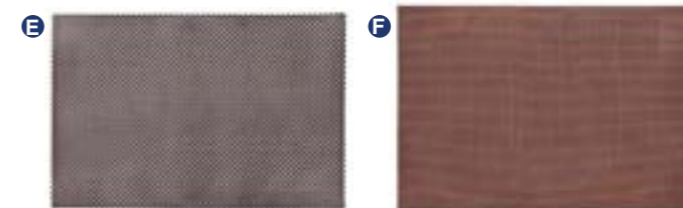
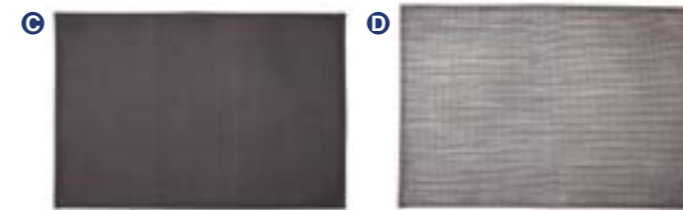
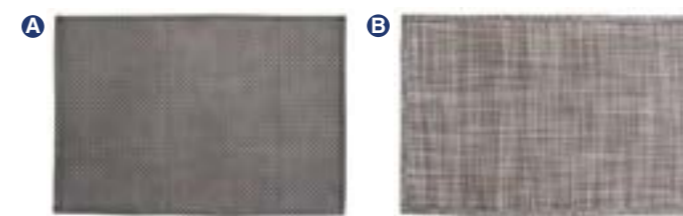

Fabricados en 75% PVC + 25% Polyester

Fait de 75% PVC + 25% Polyester / Hergestellt aus 75% PVC + 25% Polyester
Made of 75% PVC + 25% Polyester / Feita de 75% PVC + 25% Polyester

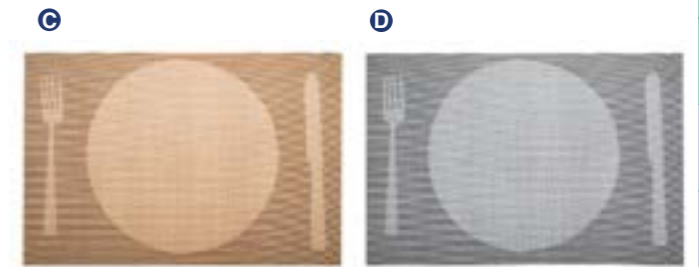
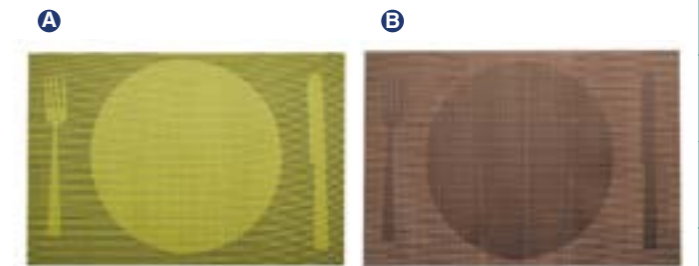

Fabricados en 75% PVC + 25% Polyester

Fait de 75% PVC + 25% Polyester / Hergestellt aus 75% PVC + 25% Polyester
Made of 75% PVC + 25% Polyester / Feita de 75% PVC + 25% Polyester

Mantel individual

Nappe individuel · Tischset
Individual placemat · Toalha de mesa individual

	Ref	€	cm	U.Venta
A	66772	4,80	45x30	6 LANTA
B	66773	4,80	45x30	6 KOTAO
C	66780	4,70	45x30	6 SUMBA
D	66781	4,70	45x30	6 BIAK
E	66782	4,70	45x30	6 GILI
F	66783	4,70	45x30	6 RINCA

Mantel individual

Nappe individuel · Tischset
Individual placemat · Toalha de mesa individual

	Ref	€	cm	U.Venta
A	66755	4,30	45x30	6 SAMUI
B	66756	4,30	45x30	6 KRABI
C	66757	4,30	45x30	6 TAPU
D	66758	4,30	45x30	6 SAMET



Fabricados en 75% PVC + 25% Polyester

Fait de 75% PVC + 25% Polyester / Hergestellt aus 75% PVC + 25% Polyester
Made of 75% PVC + 25% Polyester / Feita de 75% PVC + 25% Polyester

Camino de mesa

Chemin de table · Tischläufer
Table runner · Corre mesa

	Ref	€	cm	U.Venta
A	66790	10,60	40x140	1 BORNEO
B	66791	10,60	40x140	1 MANGOLE
C	66792	10,60	40x140	1 SIPURA
D	66793	10,60	40x140	1 TIMOR

SALVAMANTELES

Colección



ES

- Salvamantel magnético fabricado en roble de máxima calidad, muy agradable al tacto (63041).
- Salvamantel magnético fabricado en silicona de máxima calidad (63042).
- Diseñado para apoyar y transportar sartenes, ollas, cacerolas, etc. de forma cómoda y segura, sin riesgo a quemarse.
- Superresistente a altas temperaturas. Protege las superficies y las encimeras.
- No es apto para el lavavajillas.

FR

- Dessous de plat magnétique fabriqué en chêne de la plus grande qualité, très agréable au toucher (63041).
- Dessous de plat magnétique fabriqué en en silicone de qualité supérieure (63042).
- Conçu pour transporter et y poser des poêles, des casseroles, des faitouts, etc. de façon pratique et sûre, sans risquer de se brûler.
- Très résistant aux hautes températures. Protège les surfaces et les plans de travail.
- Ne peut pas être mis au lave-vaisselle.

EN

- Magnetic trivet made of top quality oak with a very nice feel (63041).
- Magnetic trivet made of top quality silicone (63042).
- Designed to hold and move frying pans, pots, casseroles etc. safely and conveniently without risk of getting burned.
- Extremely resistant to high temperatures. Protects surfaces and counter tops.
- Not dishwasher safe.

Roble
Oak



Fuerte sujeción. Potente imán integrado
Strong holding power. Powerful built in magnet

Salvamanteles magnético

Dessous de plat magnétique · Untersatzer, magnetisch
Magnetic trivet · Base para tachos magnética

Ref	€	cm	h (cm)	U.Venta
63041	21,20	23x20	1	1

Si
Silicone
Dishwasher



Base imantada GRIP line
4 potentes imanes integrados
Magnet base GRIP line
4 strong magnet integrated

Salvamanteles magnético GRIP

Dessous de plat magnétique · Untersatzer, magnetisch
Magnetic trivet · Base para tachos magnética

Ref	€	Ø (cm)	h (cm)	U.Venta
63042	8,30	20	0,6	1

Si
Silicone
Dishwasher



Flexible y antideslizante
Superresistente a altas temperaturas
Flexible and non-slip
Extremely resistant to high temperatures

Salvamanteles UNITE

Dessous de plat · Untersatzer
Trivet protector · Protector de toallas

Ref	€	cm	h (cm)	U.Venta
63043	4,10	16x16	1	1

Inox
Si
Silicone



Cerrado · closed
12,5x12,5 cm

Muy cómodo para guardar y sencillo de utilizar
Very convenient to store and easy to use

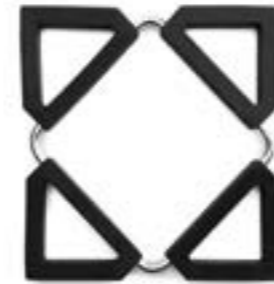

Proporcionan adherencia
Salvamanteles desplegable
Soporte de acero inoxidable
They provide adherence
Trivet foldable
Stainless steel bracket

Salvamanteles desplegable

Dessous de plats dépliant · Untersatz
Trivet foldable · Protector de toalhas dobrável

Ref	€	cm	U.Venta
66752	11,10	16x16	1

Fe
Hierro
Iron

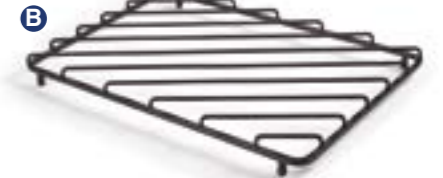

Salvamanteles

Dessous de plats · Untersatz
Trivet protector · Protector de toalhas

	Ref	€	cm	h (cm)	Varilla (mm)	U.Venta
A	61129	13,30	18,5x18,5	2,9	5x3	1
	61130	17,30	25x25	2,9	5x3	1
	61131	17,30	30x20	2,9	5x3	1
B	61132	23,70	40x25	2,9	5x3	1

Inox
18/10

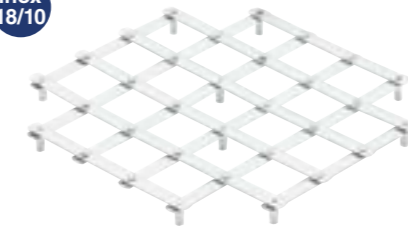

Salvamanteles

Dessous de plats · Untersatz
Trivet protector · Protector de toalhas

Ref	€	cm	h (cm)	U.Venta
63008	18,40	23x23	2,5	1

Inox



Salvamanteles redondo

Dessous de plats rond · Untersatz rund
Round trivet protector · Protector de toalhas redondo.

Ref	€	cm	h (cm)	U.Venta
63036	16,40	20x18	2	1

CUBERTEROS

Colección

- Ideal para organizar y guardar los cubiertos e utensilios de la cocina.
- No se deforma con el peso de los cubiertos.
- Apilable.

- Ideal for organizing and storing cutlery and kitchen utensils.
- It does not deform with the weight of the cutlery.
- Stackable.



4 compartimentos
4 compartments
Hueco · Hollow: 11x25x9 cm



Cubertero GN 1/1

Range-couverts · Besteckkasten
Cutlery holder · Bandeja pata talheres

Ref	€	cm	h (cm)	U.Venta
33121	11,20	52,5x32	9,5	1

PP
Polypropylene
Dishwasher
BPA free



Bastidor cromado reforzado
Reinforced chrome frame

Cubertero RATTAN PP

Range-couverts · Besteckkasten
Cutlery holder · Bandeja pata talheres

	Ref	€	cm	h (cm)	Compart.	U.Venta
A	63484	8,40	27x10	4,5	1	1
B	63485	8,40	Ø12	15,0	1	1
C	63491	74,80	53x32,5	9,0	4	1

PANERAS · FRUTEROS

Colección



- Cuerpo fabricado en acero al carbono lacado en blanco.
- Tapa fabricada en madera de caucho con orificios de ventilación para una óptima circulación del aire.
- Diseño vintage. Forma rectangular con esquinas redondeadas.
- Diseñado para conservar el pan y otros productos siempre frescos.
- 2 en 1: la tapa de madera de caucho se puede utilizar como tabla de cortar.
- Almacenamiento compacto.

- The body is made of carbon steel with white lacquer.
- The lid is made of rubberwood with ventilation holes for optimum air circulation.
- It has a vintage design. It is rectangular with rounded corners.
- It is designed to keep bread and other products always fresh.
- 2 in 1: The rubberwood lid can be used as a cutting board.
- Compact storage.



Panera NÓRDICA

Boîte à pain · Brotkasten
Bread basket · Caixa para guardar pão

Ref	€	cm	h (cm)	U.Venta
A 62868	38,60	30x18	12,5	1
B 62869	41,90	42x22,5	12,5	1

Puerta abatible. Capacidad para todo tipo de panes
Mantiene el pan protegido, prolonga su conservación
Folding door. Capacity for all kinds of breads
Keeps the bread protected and prolong its conservation

Inox



Panera abatible

Paniere rabattable · Abfallen Brotkorb
Bread bin foldable lid · Cestonreclinável

Ref	€	cm	h (cm)	U.Venta
62944	41,90	44x29	19	1

Inox



Frutero - Panera INOX

Paniere à fruit et à pain · Brot-/Obstschale
Fruits and bread basket · Fruteiro-Cesto

Ref	€	Ø (cm)	U.Venta
61821	7,50	20	1
61823	11,30	24	1



Panera KRAFT

Boîte à pain · Brotkasten
Bread basket · Caixa para guardar pão

Ref	€	cm	h max (cm)	h min (cm)	U.Venta
A 63476	13,40	10x10	25	8	1
B 63477	14,30	12x12	25	12	1
C 63478	16,20	15x15	25	12	1
D 63479	18,70	20x20	33	12	1



Panera TEX

Boîte à pain · Brotkasten
Bread basket · Caixa para guardar pão

Ref	€	cm	h max (cm)	h min (cm)	U.Venta
A 63486	13,40	10x10	25	8	1
B 63487	14,30	12x12	25	12	1
C 63488	16,20	15x15	25	12	1
D 63489	18,70	20x20	33	12	1

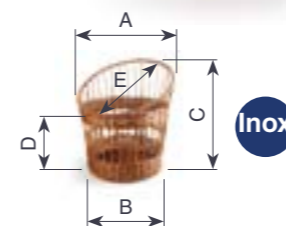

Inox

Estructura de refuerzo de acero inoxidable
Stainless steel reinforcement structure

Cesta baguette

Corbeille · Brotkorb
Basket · Cesta

Ref	€	ØA (cm)	ØB (cm)	C (cm)	D (cm)	E (cm)	U.Venta
A 63492	62,70	32,0	28,5	42,0	25,0	36,5	1
B 63493	62,70	32,0	28,5	42,0	25,0	36,5	1



- Fabricadas en fibra virgen natural.
- Material ecológico y respetuoso con el medio ambiente.
- Lavables, resistentes y duraderas.
- Diseñadas y fabricadas en España.
- Hechas a mano.
- Tacto agradable y suave, similar a la piel.
- Espesor 0,55 mm.

- Fabriquées en fibres vierges naturelles.
- Matériau écologique et respectueux de l'environnement.
- Lavables, résistantes et durables.
- Conçues et fabriquées en Espagne.
- Faites à la main.
- Toucher agréable et doux, similaire au cuir.
- Épaisseur de 0,55 mm.

- Made of natural virgin fibre.
- Ecological material respectful with the environment.
- Washable, resistant and durable.
- Designed and manufactured in Spain.
- Handmade.
- Nice soft feel, similar to leather.
- Thickness 0.55 mm.



- Cestas para pan fabricadas en polipropileno.
- Diseñadas para uso intensivo.
- Estructura de refuerzo de acero inoxidable. Parte trasera más alta que proporciona suficiente apoyo para panes largos (63492-63493).
- Material con aspecto de mimbre muy resistente, libre de BPA.
- Elaboradas a mano.
- Prácticas e higiénicas. Acabado en mate.
- Ideales para almacenar y exponer panes.
- Apilables.
- Fácil limpieza.

- Paniers pour pain fabriqués en polypropylène.
- Conçu pour une utilisation intensive.
- Structure renforcée en acier inoxydable. Partie arrière plus haute afin d'offrir un meilleur support aux pains longs (63792-63493).
- Matériau très résistant à l'aspect de rotin, sans BPA.
- Fait à la main.
- Pratiques et hygiéniques. Fini mat.
- Parfaits pour ranger et exposer des pains.
- Empilables.
- Faciles à nettoyer.

- These bread baskets are made of polypropylene.
- Designed for intensive use.
- Stainless steel reinforcement structure. The taller back gives plenty support for long loaves of bread (63792-63493).
- The very strong material looks like wicker and it's BPA free.
- Handmade.
- They're practical and hygienic. Matte finish.
- Perfect for storing or displaying bread.
- Stackable.
- Easy to clean.



Cesta de pan redonda

Corbeille a pain ronde · Brotkorb, rund
Round bread basket · Cesta de pão redonda

	Ref	€	Ø (cm)	h (cm)	U.Venta
	63471	7,70	19	8	1
A	63472	8,60	21	8	1
	63473	9,20	23	8	1
	63474	9,80	28	8	1
	63871	7,80	19	8	1
B	63872	8,60	21	8	1
	63873	9,20	23	8	1
	63874	9,90	28	8	1



Cesta de pan oval

Corbeille a pain ovale · Brotkorb, Oval
Oval bread basket · Cesta de pão oval

	Ref	€	cm	h (cm)	U.Venta
	63480	7,00	19x14	8,0	1
A	63481	8,30	24x17	8,0	1
	63482	10,10	28x16	8,5	1
	63880	7,00	19x14	8,0	1
B	63881	8,20	24x17	8,0	1
	63882	10,10	28x16	8,5	1



Cesta de pan

Corbeille a pain · Brotkorb
Bread basket · Cesta de pão

	Ref	€	Ø (cm)	h (cm)	U.Venta
A	63494	30,00	35	20	1
B	63894	29,50	35	20	1



Cesta de pan cuadrada

Corbeille a pain carré · Brotkorb, vierekig
Square bread basket · Cesta de pão quadrada

	Ref	€	cm	h (cm)	U.Venta
A	63490	34,30	53x33,5	9	1
B	63890	34,00	53x33,5	9	1

New

Medidas · Sizes
19,5x17,5x7 cm

Medidas · Sizes
29x18x8 cm



Frutero DUAL SQ

Corbeille à fruits · Obstkorb
Fruit basket · Fruteira

Ref	€	cm	h (cm)	U.Venta
61124	18,80	29x18,5	33,5	1

Madera contrachapada color haya
Plywood beech color



Frutero varillas

Corbeille à fruits · Obstschale aus Gitterstäben
Square fruit bowl · Cesto de metal para fruta

	Ref	€	Cesta (cm)	h Total (cm)	ØVarilla (mm)	U.Venta
A	61137	34,40	26x26x18,3	27,8	4	1
B	61138	34,40	Ø25,2x17,7	28,9	4	1



Frutero varillas DUAL

Corbeille à fruits · Obstschale aus Gitterstäben
Rod fruit bowl · Cesto de metal para fruta

Ref	€	Grande (cm)	Peq. (cm)	h (cm)	ØVarilla (mm)	U.Venta
61140	53,40	Ø40x10	Ø24x10	63	4	1

- Frutero de doble altura fabricado en metal y acabado negro mate.
- Asa fabricada en madera de caucho.
- Diseño transpirable: permite que el aire circule mejor, manteniendo así las frutas y verduras siempre frescas.
- 100% estable y resistente.
- Desmontable: las cestas se pueden utilizar por separado.
- Versátil: ideal para fruta, verdura, tarros de conservas, etc.

- Corbeille à fruits à double hauteur fabriquée en métal et finition noir mat.
- Poignée fabriquée en bois de caoutchouc.
- Conception aérée : permet à l'air de mieux circuler, maintenant ainsi les fruits et les légumes toujours frais.
- 100% stable et résistante.
- Démontable : les paniers peuvent être utilisés séparément.
- Polyvalente : idéale pour les fruits, les légumes, pots de conserve, etc.

- Two tier fruit basket made of metal with a matte black.
- Handle made of rubber wood.
- The breathable design lets air circulate better to keep your fruit and vegetables fresh all the time.
- 100% stable and resistant.
- Detachable: the baskets can be used separately.
- Versatile: perfect for fruit, vegetables, canning jars, etc.

Madera aglomerada
Agglomerate wood



Frutero varillas redondo bajo

Corbeille à fruits ronde basse · Obstschale aus Gitterstäben
Round low rod fruit bowl · Cesto de metal para fruta redondo baixo

Ref	€	Cesta (cm)	h (cm)	Ø Base (mm)	ØVarilla (mm)	U.Venta
61139	39,70	Ø39x6	7,6	31,3	4	1



Ideales para almacenar fruta, pan, verduras, huevos, etc.
Can be used for storing fruit, bread, vegetables, eggs, etc.

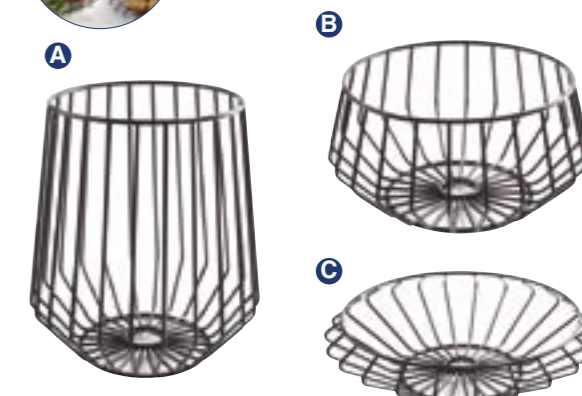

Frutero varillas

Corbeille à fruits · Obstschale aus Gitterstäben
Rod fruit bowl · Cesto de metal para fruta

	Ref	€	Ø (cm)	h (cm)	ØVarilla (mm)	U.Venta
A	61126	22,90	23,4	25,4	4	2
B	61127	20,80	27,0	13,8	4	1
C	61128	22,00	34,0	9,5	4	1

GREY PLUS

Fondue



New

ES

- Fondue eléctrica acabada en acero inoxidable de gran calidad. 1500W de potencia.
- Ideal para fundir queso, chocolate o calentar aceite.
- Olla de acero inoxidable desmontable y de 1,2 L de capacidad con fondo termodifusor para una distribución uniforme del calor.
- Termostato regulable para calentar y mantener los ingredientes siempre calientes.
- Protector antisalpicaduras extraíble con soporte para 8 tenedores.
- Incluye 8 tenedores de acero inoxidable y marcas de colores.
- Apagado de seguridad contra sobrecalentamiento.
- Pies antideslizantes. 100% estable.
- Olla, protector y tenedores aptos para el lavavajillas.

FR

- Appareil à fondue électrique avec finition en acier inoxydable de grande qualité. 1500W de puissance.
- Idéal pour faire fondre du fromage, du chocolat, ou faire chauffer de l'huile.
- Récipient en acier inoxydable démontable d'une capacité de 1,2 L avec fond thermodiffuseur pour une distribution uniforme de la chaleur.
- Thermostat réglable pour chauffer et maintenir les ingrédients toujours chauds.
- Couvercle de protection anti-éclaboussures extractible avec support pour 8 fourchettes.
- Inclut 8 fourchettes en acier inoxydable identifiées par différentes couleurs.
- Arrêt de sécurité contre la surchauffe.
- Pieds antidérapants. 100% stable.
- Récipient, couvercle et fourchettes compatibles avec le lave-vaisselle.

EN

- High quality stainless steel electric fondue set. 1500 W power.
- Ideal for melting cheese, chocolate or heating oil.
- 1.2 L removable stainless steel pot with thermo-diffuser bottom for even heat distribution.
- Adjustable thermostat to heat and keep the ingredients hot at all times.
- Removable splash guard lid that holds 8 forks.
- Includes 8 stainless steel colour marked forks.
- Overheating safety function.
- Non-slip feet. 100% stable.
- Dishwasher safe pot, lid and forks



Fondue GREY PLUS

Fondue · Fondue
Fondue · Fondue

Ref	€	W	L	U.Venta
69399	99,20	1500	1,20	1

Ref	Tensión/Voltage	Potencia/Power	Temperat./Temp.	Aceite/Oil	Capacidad/Capacity	Dimensiones/Sizes	Peso/Weight
69399	220-240 V; 50/60 Hz	1500 W	40°C - 95°C	190°C	1,20 L	29,5x21,5x24,5 cm	2,60 Kg

ROSSO

Fondue



ES

- Fondue fabricada en hierro fundido esmaltado de máxima calidad.
- Interior y exterior esmaltado que garantiza una distribución del calor uniforme sin puntos de sobrecalentamiento.
- No absorbe la humedad, los sabores, ni los olores de los alimentos.
- Diseñado para preparar deliciosas fondues de chocolate, queso, verduras, carne, etc.
- Gracias a sus dos asas laterales se puede transportar de forma segura.
- Cuenta con protección contra las salpicaduras, soporte de hierro colado y base de madera para mayor estabilidad. Además, incluye quemador de gel combustible (gel no incluido).
- La olla tiene 16,5 cm de diámetro y una capacidad de 1,2 L.
- Apta para todas las fuentes de calor, incluida la inducción.
- Incluye 6 tenedores de acero inoxidable con mango de madera y marcas de colores.

FR

- Appareil à fondue fabriqué en fonte d'aluminium émaillée de la plus grande qualité.
- Intérieur et extérieur émaillés, garantissant ainsi une distribution uniforme de la chaleur sans points de surchauffe.
- N'absorbe ni l'humidité, ni les goûts, ni les odeurs des aliments.
- Conçu pour préparer de délicieuses fondues au chocolat, fromage, légumes, viande, etc.
- Grâce à ses deux poignées latérales, il peut être transporté en toute sécurité.
- Possède une protection contre les éclaboussures, un support en métal coulé et une base en bois pour une meilleure stabilité. De plus, il inclut un brûleur de gel combustible (gel non inclus).
- Le récipient mesure 16,5 cm de diamètre et a une capacité de 1,2 L.
- Apte pour toutes les sources de chaleur, y compris l'induction.
- Inclut 6 piques en acier inoxydable avec manche en bois et marques de couleur.

EN

- Fondue pot made of top quality enamelled cast iron.
- Enamelled inside and out to guarantee even heat distribution without overheating points.
- Does not absorb humidity, flavours or odours from food.
- Designed to prepare delicious fondue with chocolate, cheese, vegetables or meats, etc.
- It can be handled safely thanks to its two side handles.
- It has splash protection, a cast iron support and a wooden base for greater stability. It also has a flammable gel burner (gel not included).
- The pot is 16.5 cm in diameter and has a 1.2 L capacity.
- It can be used with all heat sources, including induction.
- There are 6 stainless steel forks with wooden handles and coloured marks included.

Prepara deliciosas fondues de chocolate, queso, verduras, carne, etc.
Prepare delicious fondue with chocolate, cheese, vegetables or meats, etc.



Fondue ROSSO

Fondue · Fondue
Fondue · Fondue

Ref	€	L	U.Venta
71711	62,20	1,20	1



Gel de origen orgánico. No produce emanaciones tóxicas. Encendido rápido y combustión silenciosa, limpia, inodora, sin humos y sin cenizas.
Organic gel fuel. Does not produce toxic fumes. Quick-lighting and quiet-burning, clean, odourless, smokeless and ash-free.

Gel combustible ETANOL

Gel chauffe ETHANOL · Brennpaste, ETHYALKOHOL
Fuel gel, ETHANOL · Gel combustible ETANOL

Ref	€	Kg	Horas	U.Venta
A 71780	4,80	0,08	80 min	1 Set 3 latas · 3 can set
B 69108	2,70	0,225	3	72 Lata · Can
C 69107	8,60	0,840	-	1 Botella · Bottle
D 69109	39,40	4,00	-	1 Bidón · Barrel

MINI Colección



ES

- Fabricadas en aluminio fundido de máxima calidad.
- Ideal tanto para cocinar como para presentar aperitivos o platos.
- Antiadherente bicapa de alta calidad y 100% libre de PFOA.
- Libres de materiales tóxicos, pesados, disolventes y sustancias químicas.
- Diseñadas para una cocina saludable: permite cocinar sin apenas aceite garantizando que los alimentos no se peguen.
- Distribución homogénea del calor que permite una cocción rápida y uniforme.
- Aptas para todo tipo de fuegos: gas, eléctrica, vitrocerámica e inducción.
- Tapa fabricada en vidrio templado con válvula de salida de vapor.
- Pomo baquelita con acabado Soft Touch.
- Mango ergonómico con acabado Soft Touch.



Cacerola con tapa

Faitout avec couvercle · Bratentopf mit Deckel
Casserole with lid · Caçarola com tampa

Ref	€	Ø (cm)	ØBase (cm)	h (mm)	e (mm)	L	U.Venta
25160	20,90	16	12,0	5,0	1,6	0,8	1



Paellera

Plat à paella · Pfanne
Round dish · Paelheira

Ref	€	Ø (cm)	ØBase (cm)	h (mm)	e (mm)	L	U.Venta
25161	20,90	20	11,5	4,5	1,8	1,0	1



Grill

Grill · Grill Induktionfähig
Grill · Grelhador

Ref	€	cm	ØBase (cm)	h (mm)	e (mm)	U.Venta
25162	14,10	14x14	10,0	2,5	1,6	1

FR

- Fabriqué en fonte d'aluminium de la plus grande qualité.
- Idéale aussi bien pour cuisiner que pour la d'apéritifs ou de plats.
- Finition antiadhésive bi-couche de grande qualité et 100% sans PFOA.
- Sans matériaux toxiques, métaux lourds, dissolvants et substances chimiques.
- Conçue pour une cuisine saine : permet de cuisiner sans à peine utiliser d'huile et avec la garantie que les aliments ne collent pas.
- Distribution homogène de la chaleur, ce qui permet une cuisson rapide et uniforme.
- Apte pour tous types de feux : gaz, électricité, vitroceramique, four et induction.
- Couvercle fabriqué en verre trempé avec valve à vapeur.
- Poignée en bakélite avec finition Soft Touch.
- Manche ergonomique avec finition Soft Touch.

EN

- Made from a single piece of top quality cast aluminium.
- It's perfect for both cooking and presenting appetisers or dishes.
- It has a high quality bi-layer non-stick coating that is 100% PFOA free.
- It's free of toxic materials, heavy metals, solvents and chemical substances.
- It's designed for healthy cooking. It lets you cook with practically no oil and be sure that food won't stick.
- Food is cooked quickly and evenly because of the homogeneous heat distribution.
- It's suitable for all kinds of cookers: gas, electric, vitroceramic, oven and induction.
- The lid is made of tempered glass with a steam valve.
- Bakelite handle with a Soft Touch finish.
- Ergonomic handle with a Soft Touch finish.



Cazo recto

Casserole · Stielkasserole, flach
Saucepan · Caçarola direita

Ref	€	Ø (cm)	ØBase (cm)	h (mm)	e (mm)	L	U.Venta
25164	16,20	14	10,0	8,0	1,6	1,0	1



Sartén

Poêle · Pfanne
Frying pan · Sertã

Ref	€	Ø (cm)	ØBase (cm)	h (mm)	e (mm)	U.Venta
25163	12,80	14	10,0	3,0	1,6	1



COCOTTES Colección



HINWEIS: In Deutschland nicht verfügbar

ES

- Fabricadas en aluminio fundido.
- Diseño atractivo y funcional.
- Garantizan la absorción y distribución uniforme del calor, sin puntos de sobrecalentamiento.
- La distribución del calor uniforme por toda la pieza hace que los alimentos no pierdan su jugo durante la cocción, conservando así todos sus nutrientes y vitaminas.
- Las puntas situadas bajo la tapa, hacen que las gotas fruto de la condensación, vuelvan a caer sobre los alimentos formando un flujo circulante y permanente reduciendo la pérdida de sabores y jugos de los alimentos.
- Es la pieza perfecta para: arroces, carnes, pescados, legumbres, verduras, guisos, cremas, salsas, sopas, etc.
- Revestimiento antiadherente ILAG:ULTIMATE.

FR

- Fabriquée en fonte d'aluminium.
- Style attractif et grande fonctionnalité.
- Garantit l'absorption et la distribution uniforme de la chaleur, sans points de surchauffe.
- La distribution de la chaleur uniforme sur toute la pièce permet aux aliments de ne pas perdre leur jus pendant la cuisson, conservant ainsi tous leurs nutriments et vitamines.
- Les pointes situées sous le couvercle permettent aux gouttes issues de la condensation de retomber sur les aliments, formant ainsi un flux permanent de circulation qui réduit la perte des saveurs et des jus des aliments.
- C'est la pièce parfaite pour : riz, viandes, poissons, légumes, ragoûts, crèmes, sauces, soupes, etc.
- Revêtement antiadhésif ILAG: ULTIMATE.

EN

- Made in cast aluminium.
- Attractive design and great functionality.
- It guarantees the absorption and uniform distribution of heat, without overheating points.
- The uniform distribution of heat throughout the product makes keep its juices during cooking, preserving all its nutrients and vitamins.
- The points located under the lid cause the condensation drops to fall back onto the food, forming a permanent and circulating flow and reducing the loss of the food's flavours and juices.
- This is an ideal product for: rice, meats, fish, beans, vegetables, stews, creams, sauces, soups, etc.
- Non-stick coating ILAG: ULTIMATE.



Cacerola con tapa MINI

Faitout avec couvercle "MINI" · "MINI" Bratentopf mit Deckel
"MINI" round casserole with lid · Caçarola com tampa "MINI"

	Ref	€	Ø (cm)	h (cm)	L	U.Venta
	25909	22,50	10	5,0	0,24	12
A	25914	33,00	14	7,5	0,90	1
	25910	22,50	10	5,0	0,24	1
B	25915	33,00	14	7,5	0,90	1



Cacerola oval con tapa MINI

Faitout Ovale avec couvercle "MINI" · "MINI" Oval Bratentopf mit Deckel
"MINI" oval round casserole with lid · Caçarola oval com tampa "MINI"

	Ref	€	cm	h (cm)	L	U.Venta
	25911	23,70	12x8,5	5,0	0,25	1
A	25912	22,40	12x8,5	5,0	0,25	1



ES

- Construida en una sola pieza.
- Recubierta con una capa de aceite vegetal.
- Ideal para cocinar, prolonga suavemente la cocción.
- Gran conductor del calor, mantiene el calor mientras disfrutas y saboreas la comida.
- Base de madera para servir y presentar la comida recién cocinada.

FR

- Construite en une seule pièce.
- Revêtu d'une couche d'huile végétale.
- Idéal pour cuisiner, prolonge délicatement la cuisson.
- Grand conducteur de chaleur, maintient le plat au chaud pendant que vous dégustez la nourriture.
- Base en bois pour servir et présenter le plat fraîchement cuisiné.

EN

- Built in one piece.
- Coated with a layer of vegetable oil.
- Ideal for cooking; gently continues to cook.
- Great heat conductor; retains heat while you enjoy and savour the food.
- Wooden base to serve and present freshly cooked food.



Cacerola

Faitout · Bratentopf
Casserola · Caçarola

Ref	€	Ø (cm)	ml	U.Venta
25771	10,70	12,5	230	4
25772	15,60	16,2	470	4
25773	18,80	18,5	720	1



Cacerola con base

Faitout avec basse · Bratentopf mit Holzsockel
Casserola with base · Caçarola com base

Ref	€	Ø (cm)	ml	U.Venta
25871	15,40	12,5	230	4
25872	21,00	16,2	470	1
25873	27,00	18,5	720	1



Cacerola oval

Faitout ovale · Oval Bratentopf
Oval casserola · Caçarola oval

Ref	€	cm	ml	U.Venta
25781	12,10	15x10	200	4
25782	19,00	17,5x12,5	300	1
25783	21,60	21,7x15	700	1



Cacerola oval con base

Faitout ovale avec basse · Oval Bratentopf mit Holzsockel
Oval casserola with base · Caçarola oval com base

Ref	€	cm	ml	U.Venta
25881	15,60	15x10	200	4
25882	24,00	17,5x12,5	300	1
25883	26,70	21,7x15	700	1



Mini plancha grill lisa rectangular

Mini plaque grill lisse rectangulaire · Mini Platte Grill, glatt, rechteckiger
Mini rectangular grill plaque flat · Mini plancha grill liso rectangular

Ref	€	cm	h (cm)	U.Venta
25774	10,20	17x10	2,5	4



Mini plancha grill lisa rectangular con base

Mini plaque Grill lisse rectang. a/basse · Mini Platte Grill, glatt, rechteckiger m/Holzsockel
Mini rectangular grill plaque flat with base · Mini plancha grill liso rectangular c/base

Ref	€	cm	h (cm)	U.Venta
25874	15,00	17x10	2,5	4



Mini plancha grill cuadrado

Mini plaque grill carré · Mini Platte Grill, Quadrat
Mini square grill plaque · Mini plancha grill cuadrado

Ref	€	cm	h (cm)	U.Venta
25775	10,70	14x14	1,7	4



Mini plancha grill cuadrado con base

Mini plaque grill carré ave basse · Mini Platte Grill, Quadrat mit Holzsockel
Mini square grill plaque with base · Mini plancha grill cuadrado com base

Ref	€	cm	h (cm)	U.Venta
25875	15,00	14x14	1,7	4



Mini grill

Mini grill · Mini Grill
Mini grill · Mini grill

Ref	€	cm	h (cm)	U.Venta
25776	11,10	14x14	2,5	4



Mini grill con base

Mini grill avec basse · Mini Grill mit Holzsockel
Mini grill with base · Mini grill com base

Ref	€	cm	h (cm)	U.Venta
25876	17,30	14x14	2,5	1



Mini sartén lisa

Mini poêle lisse · Mini Pfanne
Mini frying pan flat · Mini sertã lisa

Ref	€	Ø (cm)	h (cm)	U.Venta
25777	11,20	13	1,7	4



Mini sartén lisa c/base

Mini poêle lisse avec basse · Mini Pfanne mit Holzsockel
Mini frying pan flat with base · Mini sertã lisa com base

Ref	€	Ø (cm)	h (cm)	U.Venta
25877	16,10	13	1,7	1

MAGMA GREY & RED

Colección



ES

- Acabado exterior e interior esmaltado, muy resistente y de gran durabilidad.
- Muy versátil: ideal para cocinar asados, arroces, pasta, cocer a fuego lento e incluso hornear tartas dulces y pan.
- Conserva todos los nutrientes, vitaminas y sabores de los alimentos.
- Excelente retención y distribución uniforme del calor.
- Incluye base de madera, ideal para servir y presentar.
- Apta para todo tipo de fuegos.

FR

- Finition extérieure et intérieure émaillée. Émail très résistant et d'une grande durabilité.
- Très versatile : idéale pour cuisiner des ragoûts, du riz, des pâtes, cuire à feu doux et même enfourner des gâteaux et du pain.
- Conserve tous les nutriments, les vitamines et les saveurs des aliments.
- Excellente rétention et distribution uniforme de la chaleur.
- Inclut une base en bois, idéale pour servir et présenter.
- Apte pour tous types de feux.

EN

- Enamel finish inside and outside. Very strong and durable enamel.
- Extremely versatile: perfect for roasts, rice, pasta, low heat cooking and even baking bread or cake.
- Preserves all the nutrients, vitamins and flavours of the food.
- Excellent heat retention and uniform heat distribution.
- Wooden base included, perfect for serving or presentation.
- Appropriate for all kinds of cookers.



Cacerola redonda

Faitout rond · Rund Bratentopf
Round casserole · Caçarola redonda

	Ref	€	Ø (cm)	h (cm)	ml	U.Venta
	25841	17,60	12,0	3,0	200	1
A	25848	27,30	16,2	3,0	470	1
	25849	33,90	18,5	3,0	720	1
	25851	17,60	12,0	3,0	200	1
B	25858	27,30	16,2	3,0	470	1
	25859	33,90	18,5	3,0	720	1

Cacerola oval

Faitout ovale · Oval Bratentopf
Oval casserole · Caçarola oval

	Ref	€	cm	h (cm)	ml	U.Venta
	25842	23,50	17,5x12,5	3,0	250	1
A	25840	33,80	21,7x15	3,0	700	1
	25852	23,70	17,5x12,5	3,0	250	1
B	25850	34,10	21,7x15	3,0	700	1



Sartén

Poêle · Pfanne
Frying pan · Sertã

	Ref	€	Ø (cm)	h (cm)	ml	U.Venta
A	25843	17,70	13,5	3,0	275	1
B	25853	17,70	13,5	3,0	275	1

Cacerola redonda con tapa

Faitout rond avec couvercle · Rund Bratentopf mit Deckel
Round casserole with lid · Caçarola redonda com tampa

	Ref	€	Ø (cm)	h (cm)	ml	U.Venta
A	25846	28,50	10	5,0	200	1
B	25856	28,50	10	5,0	200	1



Cacerola rectangular con tapa

Faitout rectangulaire avec couvercle · Bratentopf, rechteckig mit Deckel
Rectangular casserole with lid · Caçarola rectangular com tampa

	Ref	€	cm	h (cm)	ml	U.Venta
A	25845	33,40	13x9	4,5	300	1
B	25855	33,40	13x9	4,5	300	1

Cacerola oval con tapa

Faitout ovale avec couvercle · Oval Bratentopf mit Deckel
Oval casserole with lid · Caçarola oval com tampa

	Ref	€	cm	h (cm)	ml	U.Venta
A	25847	33,80	13x10	5,0	400	1
B	25857	33,80	13x10	5,0	400	1



MAGMA

Colección



ES

- Fabricadas en melamina de alta calidad.
- Libres de BPA.
- Ofrecen un aspecto muy natural parecido al hierro fundido.
- Ideales para servir y presentar los platos más exquisitos.

FR

- Fabriqué en mélamine de haute qualité.
- Sans BPA.
- Aspect très naturel, semblable à la fonte d'aluminium.
- Idéale pour servir et présenter les plats les plus exquis.

EN

- Made of high quality melamine.
- BPA free.
- Very natural appearance similar to cast iron.
- Perfect for serving and presenting the most exquisite dishes.



Cacerola redonda

Faitout rond · Rund Bratentopf
Round casserole · Caçarola redonda

Ref	€	Ø (cm)	U.Venta
63384	5,10	16	12
63385	6,20	18	12



Cacerola oval

Faitout ovale · Oval Bratentopf
Oval casserole · Caçarola roval

Ref	€	cm	U.Venta
63388	4,50	18x12	12
63389	5,80	21x15	12



Wok

Wok · Wok
Wok · Wok

Ref	€	Ø (cm)	U.Venta
63386	4,30	15	12
63387	5,90	18	12



Mini grill

Mini grill · Mini grill
Mini grill · Mini grill

Ref	€	cm	U.Venta
63382	7,40	13,5x13,5	6



Mini sartén

Mini pøele · Mini Pfanne
Mini frying pan · Mini sertã

Ref	€	Ø (cm)	U.Venta
63381	7,00	15	6



Mini sartén rectangular

Mini pøele rectangulare · Mini Pfanne, rechteckiger
Rectangular Mini frying pan · Mini sertã rectangular

Ref	€	cm	U.Venta
63383	5,10	17x11,5	12

MINI-COCOTTES

Colección



ES

- Fabricadas en melamina de alta calidad. Libres de BPA.
- Ofrecen un aspecto muy natural parecido al hierro fundido.
- Ideales para servir y presentar los platos más exquisitos.

FR

- Fabriqué en mélamine de haute qualité. Sans BPA.
- Aspect très naturel, semblable à la fonte d'aluminium.
- Idéale pour servir et présenter les plats les plus exquis.

EN

- Made of high quality melamine. BPA free.
- Very natural appearance similar to cast iron.
- Perfect for serving and presenting the most exquisite dishes.

Cacerola BLACK

Faitout · Bratentopf
Casserole · Caçarola

	Ref	€	Ø (cm)	h (cm)	ml	U.Venta
A	63390	4,40	9	4,5	150	1
B	63391	11,80	18x8,5	5,0	480	1
C	63392	11,10	10	4,5	210	1
	63393	20,10	14	6,5	640	1



Cacerola RED

Faitout · Bratentopf
Casserole · Caçarola

	Ref	€	Ø (cm)	h (cm)	ml	U.Venta
A	63394	4,40	9	4,5	150	1
B	63395	11,80	18x8,5	5,0	480	1
C	63396	11,10	10	4,5	210	1
	63397	20,10	14	6,5	640	1



Cacerola GREY

Faitout · Bratentopf
Casserole · Caçarola

	Ref	€	Ø (cm)	h (cm)	ml	U.Venta
A	63398	4,40	9	4,5	150	1
B	63399	11,80	18x8,5	5,0	480	1
C	63400	11,10	10	4,5	210	1
	63401	20,10	14	6,5	640	1



PRESENTACIÓN

Colección

Inox



NO VÁLIDOS PARA FREIR
NOT valid for frying



ES

- Fabricados en acero inoxidable de gran calidad (cestillos y cubos).
- Una forma elegante y original de servir todo tipo de aperitivos y tapas en bares, cafeterías, restaurantes o catering.
- Permiten colocar los alimentos sobre papel absorbente o bien directamente sobre el cestillo.

FR

- Fabriquées en acier inoxydable de la plus grande qualité (paniers et cubes).
- Une façon élégante et originale de servir toutes sortes d'apéritifs et de tapas dans les bars, cafés, restaurants ou traiteurs.
- Permet de déposer les aliments sur du papier absorbant ou directement sur le panier.

EN

- Made of top quality stainless steel (baskets and cubes).
- An elegant and original way of serving all kinds of snacks and tapas in bars, cafes, restaurants or catering.
- Can be presented on absorbent paper or directly on the rack.

New

Reversible
Reversible



Soporte para tacos

Support de tacos · Tacos Unterstützung
Tacos support · Suporte de tacos

	Ref	€	Tacos	cm	h (cm)	U.Venta
A	63281	4,00	1-2	12x6	4	1
B	63282	4,60	2-3	18x6	4	1
C	63283	5,40	3-4	23x6	4	1



- Fabricado en melamina de alta calidad. Libre de BPA.
- Espesor grueso, ligero y muy resistente.
- Ideal para montar y servir los tacos y evitar derrames de rellenos.
- Diseño ondulado: las ranuras en forma de V ayudan a que los tacos se mantengan erguidos.
- Multiusos: para apoyar tacos, sándwiches, burritos, perritos calientes, etc. No se recomienda mantener alimentos cocinados durante más de 24 horas.
- No apto para cocinar, asar, hornear o utilizar en el microondas.
- Apto para lavavajillas.

- Fabriqué en mélamine de grande qualité. Sans BPA.
- Très épais, léger et très résistant.
- Idéal pour faire et servir les tacos et éviter la chute de garnitures.
- Conception ondulée : les rainures en forme de V permettent aux tacos de rester droits.
- Multiusages : pour faire tenir des tacos, sandwichs, burritos, hot dogs, etc. Il n'est pas recommandé de conserver des aliments cuits pendant plus de 24 heures.
- Ne convient pas à la cuisson, au grill, au four ou au micro-ondes.
- Apte pour le lave-vaisselle.

- Made of top quality melamine. BPA free.
- Thick, lightweight and very strong.
- Ideal for making and serving tacos and preventing spillage of fillings.
- Wavy design: V-shaped grooves help keep the tacos upright.
- Multi-purpose: for holding tacos, sandwiches, burritos, hot dogs, etc. Not recommended to storage cooked food over 24 hours.
- Not suitable for cooking, grilling or baking. Not for microwave use.
- Dishwasher safe.



Cestillo redondo

Panier rond · Korb, Rund
Round basket · Cesta redonda

	Ref	€	Ø (cm)	h (cm)	U.Venta
A	61009	8,70	9	8,0	6 INOX
B	61069	8,70	9	8,0	6 BRONCE
C	61150	8,50	9	8,0	6 BLACK



Cestillo cuadrado

Panier carré · Korb, quadratisch
Square basket · Cesta cuadrada

	Ref	€	cm	h (cm)	U.Venta
A	61007	8,70	10x8	7,0	6 INOX
	61052	11,20	12x10	9,0	6
B	61067	8,70	10x8	7,0	6 BRONCE
	61062	11,20	12x10	9,0	6
C	61151	8,50	10x8	7,0	6 BLACK
	61152	10,90	12x10	9,0	6



Cestillo rectangular

Panier rectangulaire · Korb, rechteckig
Rectangular basket · Cesta rectangular

	Ref	€	cm	h (cm)	U.Venta
A	61056	13,00	21x11	6,0	1 INOX
B	61066	13,00	21x11	6,0	1 BRONCE
C	61155	12,60	21x11	6,0	1 BLACK



Mini cubo

Mini-cube · Mini-Eimer
Mini cube · Mini cubo

	Ref	€	Ø (cm)	h (cm)	ml	U.Venta
A	61107	4,80	7	7,0	200	12
B	61109	5,70	9	9,0	340	1
C	61112	7,40	12	12,0	900	1



Cestillo cónico

Panier conique · Korb, Konisch
Conical basket · Cesta cónica

	Ref	€	Ø (cm)	h (cm)	U.Venta
A	61053	9,60	12	10,0	6 INOX
B	61063	9,60	12	10,0	6 BRONCE
C	61153	9,30	12	10,0	6 BLACK



Cestillo rectangular con asas

Panier rectangulaire a/poignées · Korb, rechteckig mit Griffen
Rectangular basket with handles · Cesta rectangular com alças

	Ref	€	cm	h (cm)	U.Venta
A	61055	13,00	21x11	6,0	1 INOX
B	61065	13,00	21x11	6,0	1 BRONCE
C	61154	12,60	21x11	6,0	1 BLACK



Mini palet presentación

Mini palette de présentation · Minipalette für Präsentation
Mini pallet for presentation · Mini palette de apresentação

	Ref	€	cm	h (cm)	U.Venta
	61060	6,50	13x8	3,0	1
	61059	8,70	20x12	3,0	1
	61058	11,60	30x20	3,0	1
	61057	13,30	40x15	3,0	1



Colección SMALT

Collection · Kollektion
Collection · Coleção

	Ref	€	Ø (cm)	U.Venta
	60170	5,10	10	10
A	60172	5,70	12	10
	60175	6,70	15	6
	60180	8,60	20	6
	60192	6,50	12	6
B	60196	7,70	16	6
	60190	8,50	20	6

Esmalte vitrificado
Vitrified enamel

Paellera
Round dish

Cacerola
Casserole

BANDEJAS · TABLAS

Colección



New



Basic

Drop

Bambú Zensai

- Bandeja de bambú con 3/5 cuencos de porcelana para servir pequeñas porciones. Perfecta para cualquier evento o reunión.
- Tabla de bambú con hendiduras a medida para los cuencos.
- Capacidad de un cuenco: 100 ml (61240) / 90 ml (61241).
- Ideal para aperitivos, condimentos y salsas, frutos secos, semillas, mermeladas, etc.
- Combina de forma muy elegante el bambú y la porcelana, dándole un aspecto moderno.
- Cuencos aptos para el lavavajillas, el microondas y horno.

- Plateau en bambou avec 3/5 bols en porcelaine pour servir de petites portions. Parfait pour tous types événement ou de réunions.
- Plateau en bambou avec fentes sur mesure pour les bols.
- Capacité d'un bol: 100 ml (61240) / 90 ml (61241).
- Idéal pour les apéritifs, les condiments et les sauces, les fruits secs, les graines, les confitures, etc.
- Combine très élégamment le bambou et la porcelaine, en apportant un aspect moderne.
- Bols aptes pour le lave-vaisselle, le micro-ondes et le four.

- Bamboo tray with 3/5 porcelain bowls for serving small portions. Perfect for any event or gathering.
- Bamboo board with special recesses for the bowls to sit in.
- Bowl size: 100 ml (61240) / 90 ml (61241)
- Ideal for snacks, dressings, dips, sauces, nuts, seeds, jam, etc.
- The perfect combination of bamboo and porcelain for that stylish contemporary look.
- Dishwasher, microwave and oven safe bowls.

Bandeja con cuencos

Plateau avec bols · Tablett mit Schüsseln
Tray with bowls · Bandeja com taças

Ref	€	Base (cm)	Cuencos	ml	U.Venta
A 61240	7,30	28x10x1	8,5x8,5x3	100 (x3)	1
B 61241	7,30	28x10x1	9,5x8,5x3	90 (x3)	1
C 61243	21,70	Ø26x1	3,5	-	1

New



Fuente 5 compartimentos ZENSAI

Plat 5 compartiments · Platte mit 5 Fächern
5-compartment tray · Travessa com 5 compartimentos

Ref	€	Ø (cm)	h (cm)	Compar.	U.Venta
61242	9,40	25,5	4,0	5	1

- Bandeja fabricada en porcelana de gran calidad.
- Dispone de 5 compartimentos diseñados para servir y presentar aperitivos, snacks, salsas, etc.
- Robusto y duradero.
- Apta para el horno, microondas y lavavajillas.

- Plateau fabriqué en porcelaine de grande qualité.
- Dispose de 5 compartiments conçus pour servir et présenter des apéritifs, snacks, sauces, etc.
- Robuste et durable.
- Apte pour le four, le micro-ondes et le lave-vaisselle.

- High-quality porcelain tray.
- Features 5 compartments designed to serve and present appetisers, snacks, sauces, etc.
- Robust and long-lasting.
- Oven, microwave and dishwasher safe.



Tabla cristal & bambú

Planche verre & bambou · Glas & bambusbrett
Glass & bamboo board · Tábua vidro & bambu

Ref	€	Tabla con mango (cm)	Cristal (cm)	U.Venta
A 61048	12,60	38,5x21,5x1,5	28x18,5	1
B 61049	13,10	38,5x27,5x1,5	Ø24,5	1

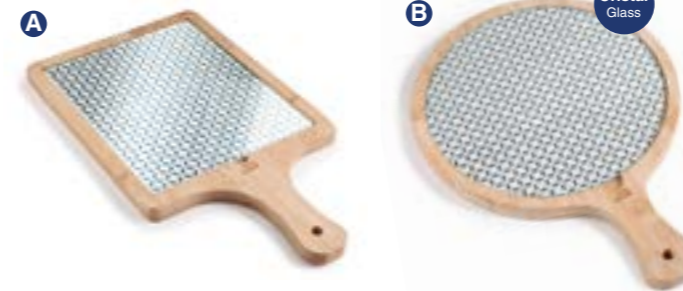

Tabla pizarra & bambú

Planche ardoise & bambou · Schiefer & bambusbrett
Slate & bamboo board · Tábua ardósia & bambu

Ref	€	Tabla con mango (cm)	Pizarra (cm)	U.Venta
A 61045	7,30	40x10x1,5	25x7,5	1
B 61046	14,60	50x18x1,5	35x15	1
C 61047	19,70	38,5x28x1,5	Ø25	1



Tabla pizarra & bambú

Planche ardoise & bambou · Schiefer & bambusbrett
Slate & bamboo board · Tábua ardósia & bambu

Ref	€	Tabla (cm)	Pizarra (cm)	Cuenco (cm)	ml	U.Venta
61042	18,40	28x28x1,5	25x15	8,5x8,5x3	56	1

New



Tabla marmol & bambú

Planche marbre & bambou · Marmor & bambusbrett
Marble & bamboo board · Tábua mármore & bambu

Ref	€	Tabla (cm)	Mármol (cm)	Cuenco (cm)	ml	U.Venta
61040	18,20	28x28x1,5	24,5x15x1	Ø8x3	100 (x3)	1

- Tabla de bambú natural con una base extraíble de mármol blanco de gran calidad de 24,5x15 cm y grosor de 1,0 cm.
- Resistente, robusto y duradero.
- Higiénica; gracias a las propiedades antibacterianas del mármol se limpia fácilmente.
- Diseñado para presentar y servir todo tipo de platos y aperitivos.
- Incluye 3 cuencos de porcelana para salsas o snacks.
- Diseño atractivo y elegante.
- Fácil limpieza: se recomienda lavar a mano.

- Natural bamboo serving board featuring a high quality removable white marble 24,5x15 cm base with 1,0 cm thickness.
- Resistant, robust and long-lasting.
- Hygienic: the antibacterial properties of marble make it easy to clean.
- Designed to present and serve all kind of dishes and snacks.
- Includes 3 porcelain bowls for sauces or snacks.
- Attractive, stylish design.
- Easy to clean. Washing by hand is recommended.

ALIÑO

Colección



Juego vinagrera BASIC
Set vinaigrie · Menage
Cruet set · Jogo galheteiro

Ref	€	ml	U.Venta
62864	13,90	175-37,5	1



Juego aceitera-vinagrera BASIC
Set huilier et vinaigries · Öl-Essig-Set
Oil-vinegar set · Jogo azeiteira-galheteiro

Ref	€	ml	U.Venta
62862	11,10	175	1



Juego salero-pimentero BASIC
Set calière et poiviere · Satz-Pfeffer-Set
Salt-pepper set · Jogo saleiro-pimenteiro

Ref	€	ml	U.Venta
62866	5,70	37,5	6



Jgo. salero-pimentero-mostaza BASIC
Set 3 pièces sel poivre moutarde · Salz/Pfeffer/Senf-Set
Salt-pepper-mustard set · Saleiro-pimenteiro-mostarda set

Ref	€	ml	U.Venta
62867	9,20	37,5-150	1



Aceitera cónica
Huilier · Ölkanne
Oil can · Azeiteira cónica

Ref	€	L	h (cm)	U.Venta
62525	28,00	0,25	10,0	1
62555	41,10	0,50	19,0	1
62551	50,50	1,00	23,0	1



Dosificador-medidor de aceite
Doseur distributeur à huile · Öl-Dosierer mit Massanzeige
Oil portionner-measurer · Distribuidor-manómetro de óleo

Ref	€	Ø (cm)	ml	U.Venta
62252	22,10	7,8x23	250	1



Pulverizador de aceite
Pulvérisateur d'huile · Öl-Spray
Oil Sprayer · Pulverizador de azeite

Ref	€	Ø (cm)	ml	U.Venta
61908	15,40	7x18	100	1



Pulverizador de aceite-vinagre
Pulvérisateur d'huile et vinaigries · Öl-Essig Spray
Oil-vinager bottle spray · Pulverizador de azeite-galheteiro

Ref	€	Ø (cm)	ml	U.Venta
61921	16,10	5,5x20	200	1



Jarra separadora grasas
Separateur de graisse · Fettabscheider
Gravy/fat separator · Separador de gorduras

Ref	€	ml	Unidades	U.Venta
61610	7,10	500	ml-oz-cup	4

ESPECIEROS

Colección



Agujeros pequeños
Small holes

Agujeros grandes
Big holes



Especiero agujeros
Saupoudreuse à figures · Gewürzdose/Streuer, Lochung
Shaker plastic cover hole lid · Polvilhador burucos

Ref	€	Ø (cm)	h (cm)	U.Venta
A 62906	8,70	7	9,50	12
B 62905	8,70	7	9,50	12



Especiero queso rayado
Saupoudreuse à fromage · Käsestreuert
Cheese shaker · Polvilhadoqueijo ralado

Ref	€	Ø (cm)	h (cm)	U.Venta
62904	8,50	7	9,50	12



Especiero malla fina
Saupoudreuse à maille · Gewürzdose/Streuer-Fein
Shaker plastic cover fine mesh lid · Polvilhador rede fina

Ref	€	Ø (cm)	h (cm)	U.Venta
62903	9,20	7	9,50	12



Pimentero
Poivrière · Pfefferstreuer
Pepper shaker · Pimenteiro

Ref	€	Ø (cm)	h (cm)	U.Venta
61903	10,60	7	12,5	1



Especiero queso rayado
Saupoudreuse à fromage · Käsestreuert
Cheese shaker · Polvilhadoqueijo ralado

Ref	€	Ø (cm)	h (cm)	U.Venta
61905	10,60	7	12,5	1



Salero
Salière · Salzstreuet
Salt shaker · Saleiro

Ref	€	Ø (cm)	h (cm)	U.Venta
61907	10,70	7	12,5	1



Azucarero
Saupoudreuse à sucre · Zuckerstreuert
Sugar shaker · Acucareiro

Ref	€	Ø (cm)	h (cm)	U.Venta
61904	12,00	7	12,5	1



Especiero malla
Saupoudreuse à maille fine · Mehlstreuer
Mesh shaker · Polvilhador rede

Ref	€	Ø (cm)	h (cm)	U.Venta
61906	11,30	7	12,5	1



Dispensador miel
Distributeur de miel · Honigbehälter
Honey dispenser · Dosificador mel

Ref	€	Ø (cm)	h (cm)	U.Venta
61909	14,00	7	12,5	1

MOLINILLOS

Colección



ES

- Muele al instante. Muelas: no pierden filo y no se oxidan.
- Molido a baja velocidad: conserva mejor las propiedades y aromas.
- Funcionamiento sencillo. Muy fácil de limpiar.

FR

- Moud à l'instant. Meules : pas d'usure du fil et pas d'oxydation.
- Mouture à faible vitesse : meilleure conservation des propriétés et des arômes.
- Fonctionnement simple. Très facile à nettoyer.

EN

- Grinds instantly. Burrs don't get dull or rusty.
- Low speed grind conserves coffee properties and aromas better.
- Easy to use. Very easy to clean.

Mecanismo de acero templado
Hardened steel mechanism



Molinillo de pimienta

Moulin à Poivre · Pfeffermühle
Pepper Grinder · Moinho de pimenta em madeira

Ref	€	Ø (cm)	h (cm)	U.Venta
63215	26,70	5,0	15	1
63220	31,30	5,5	20	1
63225	37,20	6,0	25	1

Mecanismo cerámico
Ceramic mechanism



Molinillo de sal - pimienta

Moulin à sel - poivre · Pfeffer / Salzmühle
Salt - pepper Grinder · Moinho de sal - pimenta

Ref	€	h (cm)	U.Venta
62814	23,50	14	6
62818	24,40	18	6
62823	26,40	23	6

Mecanismo cerámico
Ceramic mechanism



Molinillo doble sal - pimienta

Moulin double à sel - poivre · Salz und Pfeffermöhlner Doppelt
Salt - pepper double grinder · Moinho duplo de sal - pimenta

Ref	€	Ø (cm)	h (cm)	g	U.Venta
62816	19,50	6	18	90	1

Mecanismo cerámico
Ceramic mechanism

8 niveles de grosor
8 grinding levels



Molinillo manual

Moulin manuel · Manuelle Mühle
Manual grinder · Moinho manual

Ref	€	g	h (cm)	U.Venta
62817	33,20	45	21	1

Ideal para moler café, semillas, frutos secos, etc. Cuchillas de acero inoxidable de gran resistencia. Depósito para 60 g de granos de café molido. Perfect for grinding coffee, seeds, nuts, etc. High strength st. steel blades. Container for 60 g of ground coffee



Molinillo LIMU

Moulin électrique · Elektrische Mühle
Electric grinder · Moinho elétrico

Ref	€	U.Venta
69385	37,20	1

Ref	Tensión/Voltage	Potencia/Power	Capacidad/Capacity	Dimensiones/Sizes	Peso/Weight
69385	220-240 V ; 50/60 Hz	200 W	60 g (9 cups)	Ø10x18 cm	0,780 Kg

Mecanismo cerámico
Ceramic mechanism

Pulsadores independientes
Independent switch



6 pilas de 1,5 V AAA
(NO incluidas)
6 x 1.5V AAA batteries
(Not included)

Molinillo DUAL eléctrico sal - pimienta

Moulin DUAL électrique à sel - poivre · Elektrische Satz-/Pfeffermühle, DUAL
DUAL salt - pepper electric grinder · Moinho DUAL eléctrico sal - pimenta

Ref	€	Ø (cm)	h (cm)	U.Venta
62824	21,30	7	18	1

Inox

- Ideal para moler café y otros productos como semillas, hierbas, frutos secos, cereales, sal, pimienta o especias.
- 100% acero inoxidable: cuerpo y cuchillas fabricados en acero inoxidable de máxima calidad.
- Tapa transparente: tapa superior de color transparente para visualizar el grano molido.
- Interruptor ON/OFF: funcionamiento con un simple botón (inicio/parada).
- Interruptor de seguridad: las cuchillas se activan solo cuando la tapa está correctamente cerrada.
- Depósito para 60 g de granos de café molido.
- Almacenamiento para el cable.
- Libre de BPA.

- Idéal pour mouler le café et d'autres produits tels que les graines, les herbes, les fruits secs, les céréales, le sel, le poivre ou les épices.
- 100% acier inoxydable : Corps et lames fabriqués en acier inoxydable de la plus grande qualité.
- Couvercle transparent : Couvercle supérieur de couleur transparente pour visualiser le grain moulu.
- Interrupteur ON/OFF : Fonctionnement avec un simple bouton (marche/arrêt).
- Interrupteur de sécurité : Les lames se mettent en marche uniquement lorsque le couvercle est correctement fermé.
- Réservoir pour 60 g de grains de café moulu.
- Rangement pour le câble.
- Sans bisphénol A.

- Perfect for grinding coffee or other products like seeds, herbs, nuts, grains, salt, pepper or spices.
- 100% Stainless Steel: Body and blades made of top quality stainless steel.
- Transparent Lid: Transparent upper lid so you can see the ground product.
- ON/OFF Button: Works with a simple button (start/stop).
- Safety Switch: The blades are only activated when the lid is properly closed.
- Container for 60 g of ground coffee.
- Storage for the cord.
- BPA Free.

MESA Servicio

Inox 18/10 Dishwasher



Legumbreira

Legumiere · Servierschüssel
Vegetable dish · Legumeira

Ref	€	Ø (cm)	L	U.Venta
60812	24,80	22	2,0	1
60814	27,80	24	3,0	1
60818	36,60	28	4,5	1



Sopera con base

Soupiere sur pied · Suppenschüssel mit Fussreif
Soup-tureen with base · Sopeira com base

Ref	€	Ø (cm)	L	U.Venta
60823	31,90	22	2,00	1
60825	34,10	24	2,50	1
60829	42,00	28	4,00	1



Tapa sobpera

Couvercle soupiere · Deckel für Servierschüssel
Soup-tureen lid · Tampa sopeira

Ref	€	Ø (cm)	U.Venta
60922	20,20	22	1
60924	22,40	24	1
60928	26,30	28	1



Área útil de la base:
Base useful area:
15x10,5 cm

Recipiente de mantequilla

Réceptacle pour le beurre · Butterdose
Butter container · Recipiente para manteiga

Ref	€	cm	h (cm)	U.Venta
62898	9,80	18,5x14	6,5	1



Recipiente de mantequilla

Réceptacle pour le beurre · Butterdose
Butter container · Recipiente para manteiga

Ref	€	cm	h (cm)	U.Venta
62899	15,00	16,5x11,5	6,5	1



Ensaladera redonda

Saladier ronde · Salatschüssel, rund
Round salad bowl · Bacia de salada redonda

Ref	€	Ø (cm)	L	U.Venta
62394	12,40	25	4,0	1

garinox®



6 boles pequeños

6 petit bols · 6 Schüsseln, klein
Vegetable bowls set of 6 · 6 bacias pequenas

Ref	€	Ø (cm)	ml	U.Venta
14012	11,30	12	325	1



Salsera LUXE con cuchara

Sauciere "Luxe" · Sauciere Luxe
Gravy boat "Luxe" · Molheira "LUXE" com colher

Ref	€	ml	U.Venta
62424	23,70	200	1



Campana cubreplatos

Cloche couvre plat · Tellerlocke
Plate Cover · Campânula cobre-pratos

Ref	€	Ø (cm)	h (cm)	Total (cm)	U.Venta
61806	39,40	25	14,0	18,5	1
61809	45,10	29	15,0	20,3	1
61802	48,80	33	17,0	22,3	1
69024	25,60	24	-	11,0	1
69029	38,40	28	-	17,5	1



Salsera ALADINO

Sauciere "Aladino" · Sauciere "Aladino"
Gravy boat "Aladino" · Molheira "Aladino"

Ref	€	cm	ml	U.Venta
61409	9,50	13x6x8	90	1
61415	11,40	15,5x7,2x10	150	1
61424	15,40	19x8,5x12,5	240	1
61430	16,50	20x9,5x12,5	300	1



Quesera parmesana con cuchara

Boite à fromage a/cuillere · Parmesanmenage mit Löffel
Parmesan bowl with spoon · Queijeira parmesana c/ colher

Ref	€	Ø (cm)	ml	U.Venta
62970	31,30	9x5	200	1
* 62971	4,10		200	18

* Recipiente de cristal · Glass container



Fuente de mantequilla

Beurrer avec couvercle · Butterdose mit Deckel
Butter dish with cover · Manteigueira

Ref	€	cm	h (cm)	U.Venta
62951	14,00	11,5x22,5	6,5	1



Cubre quesos / tartas

Couvre fromage/gâteau · Tellerabdeckung
Cheese/cake cover · Cloque para queijo/tartes

Ref	€	Ø (cm)	U.Venta
62380	53,60	32	1



Quesera

Plateau à fromage avec cloche · Käseglocke
Cheese dome · Queijeira

Ref	€	U.Venta
62404	29,00	1



Azucarero sobremesa

Sucrier de table sphérique · Zuckerdose, Kugelförmig
Spherical table sugar bowl · Açucareiro de mesa esférico

Ref	€	Ø (cm)	ml	U.Venta
63304	16,90	14	600	1

- Resistentes a golpes, altas y bajas temperaturas (61806-9-2).
- Protege los alimentos de los factores externos.
- Ideales tanto para conservar como para presentar galletas, bollería, quesos y todo tipo de alimentos.
- Resistente a golpes, altas y bajas temperaturas (61806-9-2).
- Se puede introducir en el microondas, horno y congelador (61806-9-2).

- Protège les aliments des agents externes.
- Idéales aussi bien pour conserver que pour présenter des gâteaux, des viennoiseries, des fromages et tout type d'aliments.
- Résistante aux chocs ainsi qu'aux basses et hautes températures (61806-9-2).
- Peut être mise au micro-ondes, au four ou au congélateur (61806-9-2).
- Protects food from external factors.
- Perfect for preserving and presenting biscuits, pastries, cheese or any other kind of food.
- Shock, high and low temperature resistant (61806-9-2).
- Microwave, oven and freezer safe (61806-9-2).



Soporte menú con pinza

Support menu á pince · Menükartenhalter
Menu card holder · Suporte menú com pinça

Ref	€	h (cm)	U.Venta
61008	12,90	20,0	1
61012	14,40	30,0	1



Servilletero

Distributeur de serviettes · Serviettenspender
Napkin holder · Guardanapo

Ref	€	cm	h (cm)	U.Venta
61004	13,50	18x19	5,0	1



Cepillo recogemigas

Ramasse-miettes á rouleaux · Krümelbürste
Crumbs cleaner · Escova apanha-migalhas

Ref	€	cm	h (cm)	U.Venta
64407	14,70	9,5x16,5	4,0	1



Pinza sujeta manteles (4 pcs.)

Pince á nappe · Tischtuchklammer
Tablecloths pegs · Pinça para toalhas de mesa

Ref	€	U.Venta
61023	6,90	6



Indicador reservado

Indicateur résevée · Reserviert-Aufsteller
Reserved signal · Indicador reservado

Ref	€	cm	U.Venta
61098	4,30	5x12	6



Servilletero bar

Distributeur de serviettes bar · Serviettenspender bar
Bar napkin holder · Guardanapo bar

Ref	€	cm	Servilleta	U.Venta
A 61001	13,20	8,5x12,0	90x125	1
B 61002	9,40	9,5x13,5	90x125	4

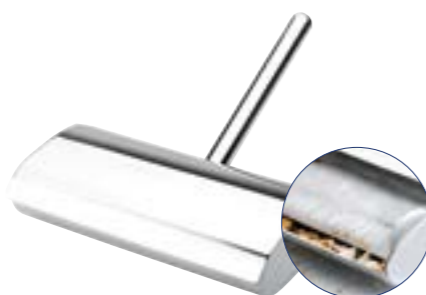

Cepillo recogedor HIPERLUXE

Ramasse-miettes á rouleaux · Krümelbürste
Crumbs cleaner · Escova apanha-migalhas

Ref	€	cm	U.Venta
64408	49,70	14,5x17	1



Números de mesa

Numéros de table · Tischnummernschild
Table numbers · Números para tabela

Ref	€	cm	Números	U.Venta
61095	20,00	6x5	1-12	1
61096	20,00	6x5	13-24	1
61097	19,90	6x5	25-36	1



Campanilla de recepción

Sonnette de réception · Rezeptionsklingel
Reception call bell · Campainha de receção

Ref	€	Ø (cm)	U.Venta
61025	11,30	10	1



Papelera sobremesa

Poubelle de table · Tish-Abfallbehälter
Table bin · Papeleira de mesa

Ref	€	Ø (cm)	L	U.Venta
63302	24,10	12x16	1,20	1



Cepillo recogedor LUXE

Ramasse-miettes · Krümelbürste
Crumbs cleaner · Espátula apanha-migalhas

Ref	€	cm	U.Venta
64409	30,90	22x7	1



Bandeja con pinza para notas

Porte addition á pince · Platte mit Klemmvorrichtung
Bill holder · Bandeja com pinça para notas

Ref	€	cm	U.Venta
A 68007	5,30	11x15,2	12
B 68017	6,20	12x21,5	12



Bandeja cambios COIN

Coupelle ramasse monnaie · Wechselgeldablagen
Changetray · Bandeja para trocos

Ref	€	Ø (cm)	U.Venta
68720	3,10	13	12



Cenicero

Cendrier · Aschenbecher
Ashtray · Cinzeiro

Ref	€	Ø (cm)	U.Venta
A 14013	2,70	14	12
A 14065	3,10	16	12
B 62941	6,20	14	1

ENCENDEDORES

Colección



ES

- Encendido con gatillo.
- Regulador de llama.
- Recargable.
- Sistema de bloque de seguridad.

FR

- Allumage avec gâchette.
- Régulateur de flamme.
- Rechargeable.
- Système de sécurité par blocage.

EN

- Trigger lighter.
- Flame regulator.
- Rechargeable.
- Safety lock system.



Caña flexible
Flexible rod



Encendedor de gas

Allume-gaz á flamme · Gasanzünder
Gas lighter · Isqueiro de gás

Ref	€	L (cm)	U.Venta
A 68987	4,00	27	6
B 68978	3,50	27	12
C 68979	4,30	27	12
D 68976	36,80	-	1
E 68977	47,20	-	1

COMBUSTIBLE Gel

ES

- Gel de origen orgánico.
- No produce emanaciones tóxicas.
- Encendido rápido y combustión silenciosa, limpia, inodora, sin humos y sin cenizas.

FR

- Gel d'origine biologique.
- Ne produit pas de fumées toxiques.
- Allumage rapide et combustion silencieuse, propre, sans odeur, sans fumée et sans cendres.

EN

- Organic gel fuel.
- Does not produce toxic fumes.
- Quick-lighting and quiet-burning, clean, odourless, smokeless and ash-free.



Contenedor de combustible

Porte-brûleur · Brennpasten-Behälter
Burner holder · Recipiente de combustível

Ref	€	Ø (cm)	h (cm)	L (cm)	Asa	U.Venta
69006	23,90	9,0	6,0	7,0		1



Gel combustible ETANOL

Gel chauffe ETHANOL · Brennpaste, ETHALKOHOL
Fuel gel, ETHANOL · Gel combustível ETANOL

Ref	€	Kg	Horas	U.Venta	
A 71780	4,80	0,08	80 min	1	Set 3 latas · 3 can set
B 69108	2,70	0,225	3	72	Lata · Can
C 69107	8,60	0,840	-	1	Botella · Bottle
D 69109	39,40	4,00	-	1	Bidón · Barrel

Pinzas
Tonge

PINZAS

Colección

Inox
18/10



Inox

Pinza servicio mesa

Pince à servir · Servierzange
Serving tong · Pinça de serviço de mesa

Ref	€	L (cm)	U.Venta
62307	4,80	21	12



Tenedor - cuchara servir

Pince à service · Servierzange
Utility tong · Garfo e colher de servir

Ref	€	L (cm)	U.Venta
68009	9,90	24	6



Cuchara pinza servir

Cuillère pince à service · Servierlöffel, Zange
Serving spoon tong · Concha pinça de servir

Ref	€	L (cm)	U.Venta
62353	12,20	24	1



Pinza para bolsitas de té

Pince pour sachets de thé · Teebeutelzange
Tea bag tong · Pinças para saquetas de chá

Ref	€	L (cm)	U.Venta
A 68078	2,30	13,5	1
B 68079	3,50	14,0	1

- Exprime fácilmente tu infusión sin riesgo de mancharte o quemarte.
- Diseñada para una extracción fácil y efectiva de la bolsa de té.
- Orificios para exprimir hasta la última gota.
- Mango de acero inoxidable para un agarre cómodo y seguro.

- Squeeze easily your infusion without the risk of leaving or burning yourself.
- Designed for easy and effective tea bag removal.
- Holes for squeezing out the last drop.
- Stainless steel handle for a comfortable and safe grip.



Pinza azucarillos

Pince à sucre · Zucker-Zange
Food tong · Pinça p/cubos de açúcar

Ref	€	L (cm)	U.Venta
62985	3,70	11	6



Pinza hamburguesa

Pince inox pour hamburger · Zange für Burgers
Tongs for beef Burgers · Pinça de hamburger

Ref	€	L (cm)	U.Venta
62318	11,90	24	12



Pinza pasta LUXE

Pince à spaghetti · Teigwaren-Zange
Pasta Tong · Pinça massas

Ref	€	L (cm)	U.Venta
62981	10,10	20	1



Pinza pasta

Pince à spaghetti · Teigwaren-Zange
Spaguetti Tong · Pinça massas

Ref	€	L (cm)	U.Venta
62986	5,40	19	12



B

Inox

Pinza hielo

Pince à glace · Eiszange
Ice tong · Pinça de gelo

Ref	€	L (cm)	U.Venta
A 62306	4,60	18,5	12
B 62337	9,90	20,0	12



Pinza multiusos LUXE

Pince multi-usages · Allzweck Zange
Multipurpose tong · Pinça multiusos

Ref	€	L (cm)	U.Venta
62334	19,80	25	1



Pinza multiusos

Pince multi-usages · Allzweck-Zange
Luxe tong · Pinça multiusos

Ref	€	L (cm)	U.Venta
62984	3,80	16	5



Pinza pan

Pince à pain · Brotzange
Bread tong · Pinça pão

Ref	€	L (cm)	U.Venta
62978	8,80	18	1



Pinza pan

Pince à pain · Brotzange
Bread tong · Pinça pão

Ref	€	L (cm)	U.Venta
62982	16,90	23	12



Pinza ensalada

Pinces a salade · Salatzange
Salad scissor tong · Pinça de salada

Ref	€	L (cm)	U.Venta
68021	4,80	28,5	12

PS
plastic
BPA free



Pinza LUXE

Pince · Zange
Tong · Pinça

Ref	€	L (cm)	U.Venta
62983	15,30	30	12



Pinza grill

Pince à grill · Grilltange
Grill tong · Pinça grelhador

Ref	€	L (cm)	U.Venta
62933	15,00	30	6



Pinza grill

Pince à grill · Grilltange
Grill tong · Pinça grelhador

Ref	€	L (cm)	U.Venta
62931	9,00	29	1

Si
Silicone
200
°C
Gas
BPA free



ASA
acrylic
BPA free

Tenedor + cuchara ensalada

Fourchette + cuillère a salade · Gabel + Löffel Acryl
Salad spoon + fork · Garfo + colher de salada

Ref	€	L (cm)	U.Venta
62399	7,60	30	1



Pinza repostería

Pince à gateau · Gebäck-Tortenzange
Cake tong · Pinça pastelaria

Ref	€	L (cm)	U.Venta
62317	11,70	20	1



Pinza repostería con anillas

Pince à gateau avec anneaux · Gebäckzange
Cake tong with rings · Pinça pastelaria com anilhas

Ref	€	L (cm)	U.Venta
68008	5,90	16	6



Pinza JUMBO

Pince de service · Zange
Utility tong · Pinça

Ref	€	L (cm)	U.Venta
62924	5,70	24	12
62930	6,70	30	12
62940	7,90	40	12

Inox
Inox
PA
nylon
BPA free



Pinza JUMBO NYLON

Pince de service · Zange
Utility tong · Pinça

Ref	€	L (cm)	U.Venta
62926	7,40	24	12
62929	8,60	30	12
62939	11,10	40	12



Pinza JUMBO SILICONA

Pince de service · Zange
Utility tong · Pinça

Ref	€	L (cm)	U.Venta
63926	7,40	24	12
63929	8,60	30	12
63939	11,10	40	12

New



2 in 1

Pinza DUPLO

Pince · Zange
Tong · Pinça

Ref	€	L (cm)	U.Venta
63049	11,60	30	1



- Fabricada en acero inoxidable 18/10 con bordes biselados y mango termorresistente.
- Pinza interior fabricada en nylon. No raya ni daña artículos de cocina con antiadherente. Resistente al calor.
- Fácil limpieza: aptas para el lavavajillas.
- Fabriquée en acier inoxydable 18/10 avec des bords biseautés et un manche thermorésistant.
- Pince intérieure fabriqué en nylon. Ne raye pas et n'endommage pas les ustensiles de cuisine antiadhésifs. Résistante à la chaleur.
- Nettoyage facile : apte pour le lave-vaisselle.
- Made of 18/10 stainless steel with bevelled edges and a heat resistant handle.
- Inner tong made of nylon. Does not scratch cooking utensils with non-stick coating. Heat resistant.
- Easy to Clean: dishwasher safe.

Mango revestido con una capa de aislante térmica para una mejor sujeción
Handle coated with a layer of thermal insulation and an enhanced grip



Pinzas KARU

Pinces · Zanges
Tongs · Pinças

	Ref	€	L (cm)	Color	U.Venta	Ref	€	L (cm)
A	63060	7,30	24	Rojo · Red	12	63070	7,90	30
B	63061	7,30	24	Negro · Black	12	63071	7,90	30
C	63062	7,30	24	Azul · Blue	12	63072	7,90	30
D	63063	7,30	24	Amarillo · Yellow	12	63073	7,90	30
E	63064	7,30	24	Verde · Green	12	63074	7,90	30
F	63065	7,30	24	Marrón · Brown	12	63075	7,90	30



Pinzas silicona

Pinces silicon · Silikon Zanges
Silicone tongs · Pinças silicone

	Ref	€	L (cm)	Color	U.Venta
A	64434	67,50	18,0	Caja (25 pcs.) · Set (25 pcs.)	1
B	64432	2,90	18,0	Naranja · Orange	12
C	64433	2,90	18,0	Rojo · Red	12
D	64436	2,90	18,0	Azul · Blue	12
E	64437	2,90	18,0	Verde · Green	12
F	64439	2,90	18,0	Morada · Purple	12



PINZAS PRECISIÓN

Colección

Inox 18/10 Dishwasher



ES

- Pinzas de precisión fabricada en acero inoxidable 18/10 de máxima calidad.
- Ideales para manipular y emplatar tus creaciones a la perfección.
- Mango antideslizante y puntas acanaladas para una sujeción 100% segura.
- Aptas para lavavajillas.

FR

- Pincés à dresser fabriquée en acier inoxydable 18/10 de la plus grande qualité.
- Idéales pour manipuler et dresser vos créations à la perfection.
- Manche antidérapant et pointes rainurées pour une adhésion 100% efficace.
- Apte pour le lave-vaisselle.

EN

- Precision tongs made of top quality 18/10 stainless steel.
- Perfects for presenting your creations with solid food.
- Non-slip handle and channelled tips for 100% secure holding.
- Dishwasher safe.

Puntas curvas puntiagudas y rugosas
Curved tips pointed and rough



Pinza de precisión recta

Pince de précision droite · Präzisionszange glatt
Straight precision tong · Pinça de precisão reta

Ref	€	L (cm)	U.Venta
62955	5,30	15,5	1
62956	10,30	21,0	1

Acabado negro mate
Finish in matte black



Pinza de precisión TITAN BLACK

Pince de précision · Präzision zange
Precision tong · Pinça de precisão

Ref	€	L (cm)	U.Venta
62872	5,90	21	1
62874	4,50	16	1

Pinza de precisión acodada

Pince de précision · Präzision zange
Precision tong · Pinça de precisão

Ref	€	L (cm)	U.Venta
62865	4,70	15,5	1

Acabado iridiscente
Iridescent finish



Pinza de precisión TITAN RAINBO

Pince de précision · Präzision zange
Precision tong · Pinça de precisão

Ref	€	L (cm)	U.Venta
62873	5,90	21	1
62875	4,50	16	1



Pinza de precisión INOX

Pince de précision · Präzision zange
Precision tong · Pinça de precisão

	Ref	€	L (cm)	U.Venta
A	62954	5,30	16	1
B	62821	6,20	21	1



Pinza de precisión con cuchara

Pince de précision a/cuillère · Präzision zange m/Löffel
Precision tong with spoon · Pinça de precisão c/colher

Ref	€	L (cm)	U.Venta
62863	5,80	17,0	1



Cuchara para miel

Cuillère à miel · Honiglöffel aus Edelstahl
St steel honey spoon · Colher para mel

Ref	€	L (cm)	U.Venta
61361	10,60	16,5	1

Zamak
Zinc alloy



Tenaza extractor huesos aceitunas

Dénoyauteur, Chromé · Olivenentsteiner, Verchromt
Zinc alloy live seed remover · Tenaz extrator de ossos de azeitonas

Ref	€	L (cm)	U.Venta
62973	8,00	16	1



Pinza para horno/bandeja GN

Pince inox pour bac GN · Zange für GN Behälter
Tong GN tray · Pinça para forno e bandejas GN

Ref	€	L (cm)	U.Venta
62989	17,00	20	12



Pinza quitaespinas

Pince à arêtes · Grätenzange
Fish-bone tweezers · Pinça tira-espinhas

Ref	€	L (cm)	U.Venta
62938	4,70	8	1
62928	5,90	12	1

Inox



Desescamador de pescado MINI

Grattoir de poissons · Fischschuppenentferner
Fish scraper · Raspador de peixe

Ref	€	L (cm)	U.Venta
39040	8,20	19	1



Las escamas se quedan atrapadas en la funda
The scales get trapped in the cover

Sistema patentado

Si
Silicone

A

Click here



Doble hojas dentadas
Double toothed slats

Desescamador de pescado SAFE

Grattoir de poissons · Fischschuppenentferner
Fish scraper · Raspador de peixe

Ref	€	L (cm)	U.Venta
39041	11,80	27,5	1

Ref	€	Cabezal (cm)	L (cm)	U.Venta
39042	24,00	9x13,5	30	1
A R39042A	7,90	9x13,5	14	1

Funda silicona
Silicone cover



Si
Silicone

200
°C

Pinza para horno/bandeja GN

Pince inox pour bac GN · Zange für GN Behälter
Tong GN tray · Pinça para forno e bandejas GN

Ref	€	L (cm)	U.Venta
62998	17,00	20	12

Zamak
Zinc alloy



Cascanueces BASIC

Casse Noix · Nussknacker
Nut Cracker · Parte-nozes

Ref	€	U.Venta
63016	15,40	6

Zamak
Zinc alloy



Cascanueces

Casse Noix · Nussknacker
Nut Cracker · Parte-nozes

Ref	€	U.Venta
63017	19,30	6

3 in 1

Inox



Tenaza marisco

Pince à casse-homard · Hummerzange
Lobster cracker · Tenaz mariscos

Ref	€	L (cm)	U.Venta
62908	15,50	16	12

Inox



Tijera - tenaza marisco

Pince casse homard · Schere/Zange Meeresfrüchte
Sea food scissor-tong · Tesoura-tenaz marisco

Ref	€	L (cm)	U.Venta
62974	17,10	18,5	12

Abre ostras LUXE

Couteau à huîtres · Austermesser
Oyster openne · Aberto-ostras

Ref	€	L (cm)	U.Venta
62684	12,60	20	1



6
units

Pinchos para marisco

Curettes à homard · Hummergabel
Seafood forks · Espetos para marisco

Ref	€	L (cm)	U.Venta
62976	29,90	18,5	1

New



Pinza quitaespinas

Pince à arêtes · Grätenzange
Fish-bone tweezers · Pinça tira-espinhas

Ref	€	L (cm)	U.Venta
62879	4,70	13	1

- Pinza especial para quitar de forma precisa las espinas del pescado.
- Fabricada en acero inoxidable 18/10 de alta calidad.
- Brazos curvados; facilitan su agarre y le dan más fuerza
- Acabado en mate. Higiénica y resistente.

- Pince spécialement conçue pour retirer avec précision les arêtes du poisson.
- Fabriquée en acier inoxydable 18/10 de grande qualité.
- Bras courbés ; facilite la prise en main et lui donne plus de force.
- Finition mate. Hygiénique et durable.

- Special tweezers for precise removal of fish bones.
- Made of top quality 18/10 stainless steel.
- Curved arms; easier to grip and give you more strength.
- Matt finish. Hygienic and durable.

BBQ Colección

Inox



ES

- Práctico maletín de aluminio compuesto por 5 utensilios para barbacoa: espátula, tenedor, cuchillo, pinza dentada y brocha.
- Todas las piezas fabricadas en acero inoxidable de máxima calidad.
- Mango ergonómico, resistente al calor.
- Maletín rectangular portátil con el interior forrado.
- Completa el set con los accesorios adicionales: espátula acodada y cepillo de limpieza.

FR

- Malette pratique en aluminium composée de 5 ustensiles pour barbecue : spatule, fourchette, couteau, pince dentée et broche.
- Toutes les pièces sont fabriquées en acier inoxydable de la plus grande qualité.
- Manche ergonomique, résistant à la chaleur.
- Malette rectangulaire transportable avec revêtement intérieur.
- Complétez l'ensemble avec les accessoires supplémentaires : spatule coudée et brosse de nettoyage.

EN

- Practical aluminium case with 5 barbecue utensils: spatula, fork, knife, serrated tongs and brush.
- All parts made of top-quality stainless steel.
- Ergonomic, heat-resistant handle.
- Portable rectangular case with lined interior.
- Complete the set with these additional accessories: angled spatula and cleaning brush.



Maletín

Malette · Koffer
Briefcase · Maleta

Ref	€	cm	U.Venta
60260	46,70	47x16,6x8	1



Tenedor

Fourchette · Tranchiergabel
Fork · Garfo

Ref	€	L (cm)	U.Venta
60261	5,10	43,5	1



Cuchillo

Couteau · Messer
Knife · Faca

Ref	€	L (cm)	U.Venta
60262	4,90	41,5	1



Espátula

Spatule · Schaufel
Spatule · Espátula

Ref	€	L (cm)	U.Venta
60263	8,10	45,5	1



Brocha

Broche · Bürstes
Brush · Escova

Ref	€	L (cm)	U.Venta
60264	6,10	44,0	1



Pinza

Pincs · Zange
Tong · Pinça

Ref	€	L (cm)	U.Venta
60265	9,90	43,5	1

Accesorios · Accessoires · Accessories



Espátula acodada

Spatule coudées · Winkelpalette
Bent spatule · Espátula comprida

Ref	€	L (cm)	U.Venta
60266	5,80	28,0	1



Cepillo de limpieza

Brosse de nettoyage · Reinigungsbürste
Cleaning brush · Escova de limpeza

Ref	€	L (cm)	U.Venta
60267	6,80	45,0	1

MOLINILLOS DE CAFÉ

Colección



Número de tazas Number of cups	Tiempo de molido Grinding time
2	8 seg
4	12 seg
6	20 seg
8	24 seg
10	28 seg
12	30 seg

19 diferentes niveles de molienda · 19 different grind sizes



Molinillo KALDI

Moulin · Mühle
Grinder · Moinho

Ref	€	W	g	U.Venta
69485	117,70	200	200 / 100	1

- Disfruta de todo el aroma y sabor de un café recién molido.
- Embudo de 200 g de capacidad con tapa.
- Fresa cónica de acero inoxidable; muele el café uniformemente.
- 19 diferentes niveles de molido; se adapta a todo tipo de cafeteras y a la intensidad de sabor que se desee.
- Selector de tazas de 1 a 12 tazas. Mantiene los granos frescos y evita el desperdicio del café.
- Contenedor transparente extraíble de 100 g. Libre de BPA.

- Enjoy the taste and aroma of freshly ground coffee.
- Hopper with a capacity of 200 g with a lid.
- Conical stainless steel cutter to ensure the coffee is ground uniformly.
- 19 different grind sizes to choose from, suitable for all types of coffee machines and for all flavour intensities.
- Choose between 1 and 12 cups to keep the coffee grounds fresh and avoid wasting coffee.
- Removable 100 g transparent container.BPA-free.

Características · Characteristics:

Referencia · Reference: 69485
Tensión · Voltage: 220-240 V; 50-60 Hz
Potencia · Power: 200 W
Capacidad · Capacity: 200 g (grano · grains) / 100 g (molido · ground)
Niveles de molido · Grinding levels: 19
Dimensiones · Sizes: 15,2x21x26 cm
Peso · Weight: 1,85 kg

Inox

60 g



Ideal para moler café, semillas, frutos secos, etc.
Perfect for grinding coffee, seeds, nuts, etc.



Molinillo LIMU

Moulin · Mühle
Grinder · Moinho

Ref	€	W	g	U.Venta
69385	37,20	200	60	1

- 100% acero inoxidable: cuerpo y cuchillas fabricados en acero inoxidable de máxima calidad.
- Tapa transparente: tapa superior de color transparente para visualizar el grano molido. Libre de BPA.
- Interruptor ON/OFF: funcionamiento con un simple botón (inicio/parada).
- Interruptor de seguridad: las cuchillas se activan solo cuando la tapa está correctamente cerrada.
- Almacenamiento para el cable.

- 100% Stainless Steel: Body and blades made of top quality stainless steel.
- Transparent Lid: Transparent upper lid so you can see the ground product. BPA Free.
- ON/OFF Button: Works with a simple button (start/stop).
- Safety Switch: The blades are only activated when the lid is properly closed.
- Storage for the cord.

Características · Characteristics:

Referencia · Reference: 69385
Tensión · Voltage: 220-240 V; 50-60 Hz
Potencia · Power: 200 W
Capacidad · Capacity: 60 g (9 cups)
Dimensiones · Sizes: Ø10x18 cm
Peso · Weight: 0,78 kg



8 niveles de grosor
8 grinding levels

Inox 18/10
Cristal Glass



Mecanismo cerámico
Ceramic mechanism



Molinillo manual

Moulin manuel · Manuelle Mühle
Manual grinder · Moinho manual

Ref	€	g	h (cm)	U.Venta
62817	33,20	45	21	1

8 Niveles de grosor · 8 Grinding levels



- Muele al instante y conserva mejor las propiedades y aromas.
- Ideal para moler café y otros alimentos como semillas, hierbas, frutos secos, cereales, sal, pimienta, azúcar o especias.

- Moud à l'instant et conserve mieux les propriétés et les arômes.
- Idéal pour moudre le café et d'autres aliments tels que les graines, les herbes, les fruitssecs, les céréales, le sel, le poivre ou les épice.

- Grinds instantly and better preserves the properties and aromas.
- Perfect for grinding coffee or other aliments like seeds, herbs, nuts, grains, salt, pepper, sugar or spices.

ESPUMADORES DE LECHE

Colección



ES

- Disfruta de una espuma fina y cremosa en pocos segundos.
- Capacidad espuma: 115 ml / Capac. calentamiento: 240 ml (69396) - 250 ml (69398).
- Tecnología magnética, el movimiento de los accesorios se crea por atracción (69398).
- Base independiente rotativa de 360°, fácil de rellenar y verter.
- Funcionamiento silencioso. Apagado automático.
- Indicador de luz que visualiza si la leche está caliente o fría.
- Apta para leches vegetales. Fácil de limpiar.

FR

- Obtenez une mousse fine et crémeuse en secondes seulement.
- Capacité de mousse : 115 ml / Capacité de chauffe : 240 ml (69396) - 250 ml (69398).
- Technologie magnétique, le mouvement des accessoires a lieu par attraction (69398).
- Base indépendante rotative de 360°C, sans fil, facile à remplir et à verser.
- Fonctionnement silencieux. Arrêt automatique.
- Indicateur lumineux qui indique si le lait est chaud ou froid.
- Apte pour les laits végétaux. Facile à nettoyer.

EN

- Enjoy a fine, creamy foam in as little seconds.
- Frothing capacity: 115 ml / Heating capacity: 240 ml (69396) - 250 ml (69398).
- Magnetic technology: The movement of the accessories is created with attraction (69398).
- 360° rotating independent base, easy to fill and pour.
- Silent operation. Automatic shut-off.
- The indicator light shows whether the milk is hot or cold.
- Suitable for plant milk and easy to clean.



Calentar
Heat



Calentar y espumar.
Espumar leche fría
Heat and froth.
Froth cold milk

Espumador de leche LATTE

Mousseur à lait · Milchaufschäumer
Milk frother · Espumador de leite

Ref	€	W	ml	U.Venta
69396	61,80	500	240	1

Ref	Tensión/Voltage	Potencia/Power	Cap. espuma/Cap. foam	Cap. leche/Cap. milk	Base/Base	Dimensiones/Sizes	Peso/Weight
69396	220-240 V; 50/60 Hz	500 W	115 ml	240 ml	360°	Ø10x21 cm	650 g
69398	220-240 V; 50/60 Hz	600 W	115 ml	250 ml	360°	Ø11,8x19,5 cm	900 g

Espumador de leche MAGNETIC

Mousseur à lait · Milchaufschäumer
Milk frother · Espumador de leite

Ref	€	W	ml	U.Venta
69398	76,80	600	250	1

CAFETERAS EXPRESSO

Colección

Inox  



Prepara
1 o 2 cafés
Make 1 or 2 coffees

Calienta y espuma
la leche
Heat and froth milk



Cafetera espresso SENCE

Cafetière espresso · Espresso-Maschine
Espresso coffee maker · Cafeteira espresso

Ref	€	W	L	U.Venta
69256	184,20	850	1,50	1

- Cafetera espresso ideal para preparar todo tipo de cafés, espresso, cappuccino, latte machiato, etc.
- Conseguirás un café perfecto y rápido gracias a sus 15 bares de presión.
- Fácil de usar, muy intuitiva. Indicadores luminosos en cada función.
- Función manual y automática. Permite programar el ciclo de vertido a tu gusto.
- Incluye vaporizador con protección para espumar leche y preparar cappuccinos.
- Brazo portafiltros con doble salida, te permite preparar uno o dos cafés a la vez.
- Depósito de agua extraíble de 1,5 litros de capacidad con marcas de máximo y mínimo.
- Bandeja calienta tazas de acero inoxidable, calienta la taza previamente para evitar el contraste térmico.
- Incluye cucharilla dosificadora con prensador para el café y 3 filtros (individual, doble y para usar cápsulas ESE) para acoplar al brazo de la cafetera.
- Bandeja de goteo desmontable con indicador de nivel para facilitar la limpieza.
- Sistema de ahorro energético con apagado automático.
- Apta para usar con café molido y con cápsulas ESE.

- Espresso coffee machine, perfect for making all types of coffee, including espresso, cappuccino, latte, macchiato, etc.
- You'll have a perfect coffee in no time at all thanks to its 15 pressure bars.
- It's easy to use and very intuitive. Each function is accompanied by light indicators
- Manual and automatic settings. You can personalise the pouring time.
- Includes a steam wand with a protector for frothing milk, dispensing hot water for teas and preparing cappuccinos.
- The two-spout filter holder allows you to make one or two coffees at the same time.
- Removable 1.5-litre water tank with minimum and maximum water level marks.
- Stainless steel cup-warming tray heats up the cups before using them to keep the coffee warmer for longer.
- Includes a coffee measuring spoon and tamper and 2 filters (single, double and to use ESE capsules) to attach to the handle.
- Detachable drip tray with water level indicator to aid cleaning.
- Energy-saving system with automatic shut-off.
- Suitable for use with ground coffee and ESE capsules.



Prepara
1 o 2 cafés
Make 1 or 2 coffees

Calienta y espuma
la leche
Heat and froth milk



Cafetera espresso COMPACT

Cafetière espresso · Espresso-Maschine
Espresso coffee maker · Cafeteira espresso

Ref	€	W	L	U.Venta
69429	228,90	1450	1,25	1

- Ideal para preparar todo tipo de cafés, espresso, cappuccino, latte machiato, té o infusiones.
- Su sistema de calentamiento rápido Thermoblock calienta el agua en segundos.
- Fácil de usar, muy intuitiva. Indicadores luminosos en cada función.
- Función manual y automática. Permite programar el ciclo de vertido a tu gusto.
- Incluye vaporizador con rotación para espumar leche y preparar cappuccino. También dispensa agua caliente para las infusiones.
- Brazo portafiltros con doble salida, te permite preparar uno o dos cafés simultáneamente.
- Depósito de agua extraíble de 1,25 litros de capacidad con marcas de máximo y mínimo. Libre de BPA.
- Bandeja calienta tazas de acero inoxidable, calienta la taza previamente para evitar el contraste térmico.
- Incluye cucharilla dosificadora con prensador para el café y 3 filtros (individual, doble y para usar cápsulas ESE) para acoplar al brazo de la cafetera.
- Bandeja de goteo desmontable con indicador de nivel para facilitar la limpieza.
- Sistema de ahorro energético con apagado automático.
- Apta para usar con café molido y con cápsulas ESE.

- It's perfect for making all kinds of coffee, espresso, cappuccino, latte macchiato, tea or infusions.
- Its Thermoblock fast heating system heats water in seconds.
- It is easy to use and very intuitive and has light indicators for every function.
- Manual and automatic operation, the amount of coffee to be made can be programmed to taste.
- Swivelling steam wand included to froth milk and make cappuccino. It also dispenses hot water for infusions.
- The portafilter with two outlets lets you make one or two cups of coffee at the same time.
- It has a removable 1.25 litre water tank with minimum and maximum marks. BPA free.
- It has a stainless steel cup heating tray to heat cups beforehand to prevent temperature contrasts.
- It includes a spoon with a tamper for coffee and three filters (single, double and for using ESE pods) that attach to the portafilter.
- It has a removable drip tray with a level indicator to make cleaning easy.
- It has an energy savings system with automatic shut off.
- It can be used with ground coffee or ESE pods.

Ref	Tensión/Voltage	Potencia/Power	Presión/Pressure	Capacidad/Capacity	Dimensiones/Sizes	Peso/Weight
69429	220-240 V ; 50/60 Hz	1450 W	20 bar	1,25 L	14x31x31 cm	3,40 Kg

Ref	Tensión/Voltage	Potencia/Power	Presión/Pressure	Capacidad/Capacity	Dimensiones/Sizes	Peso/Weight
69256	220-240 V ; 50/60 Hz	850 W	15 bar	1,50 L	21x26,5x30 cm	3,60 Kg



Prepara
1 o 2 cafés
Make 1 or 2 coffees

Calienta y espuma
la leche
Heat and froth milk



Cafetera Espresso PRO

Cafetière espresso · Espresso-Maschine
Espresso coffee maker · Cafeteira espresso

Ref	€	W	L	U.Venta
69428	641,90	1550	2,80	1

- Cafetera espresso de acero inoxidable con acabado pulido. Ideal para preparar todo tipo de cafés, espresso, cappuccino, latte machiato, té o infusiones.
- Consigue un café perfecto y rápido gracias a su potencia de 1550 W y sus 20 bares de presión.
- Molinillo con fresa cónica de acero inoxidable integrado que proporciona la cantidad necesaria de café.
- Depósito de café de 250g con opción de regular entre 30 tipos de molido. Libre de BPA.
- Control de temperatura PID. Alcanza la temperatura de extracción óptima.
- Fácil de usar, muy intuitiva. Indicadores luminosos en cada función.
- Función manual y automática. Permite programar la cantidad de vertido a tu gusto.
- Incluye vaporizador con rotación para espumar leche y preparar cappuccino. También dispensa agua caliente para las infusiones.
- Brazo portafiltros con doble salida, te permite preparar uno o dos cafés simultáneamente.
- Depósito de agua extraíble de 2,8 litros de capacidad con marcas de máximo y mínimo. Libre de BPA.
- Incluye prensador de acero inoxidable para el café, 2 filtros (individual y doble) para acoplar al brazo de la cafetera y jarra de acero inoxidable de 0,46 L para la leche.
- Bandeja de goteo desmontable con indicador de nivel para facilitar la limpieza.
- Sistema de ahorro energético con apagado automático.

- Stainless steel espresso maker with a polished finish
- It's perfect for making all kinds of coffee, espresso, cappuccino, latte macchiato, tea or infusions.
- It can make perfect coffee quickly thanks to its 1550 W of power and 20 bars of pressure.
- A coffee grinder with a stainless steel cone burr that provides the right amount of coffee.
- It has a 250 g bean hopper and 30 types of grinding to choose from. It's BPA free.
- PID temperature control, it uses the optimum extraction temperature.
- It is easy to use and very intuitive and has light indicators for every function.
- Manual and automatic operation, the amount of coffee to be made can be programmed to taste.
- Swivelling steam wand included to froth milk and make cappuccino. It also dispenses hot water for infusions.
- The portafilter with two outlets lets you make one or two cups of coffee at the same time.
- It has a removable 2.8 litre water tank with minimum and maximum marks. BPA free.
- It includes a stainless steel tamper for coffee, two filters (single and double) that attach to the portafilter and a 0.46 L stainless steel pitcher for milk.
- It has a removable drip tray with a level indicator to make cleaning easy.
- It has an energy savings system with automatic shut off.

Ref	Tensión/Voltage	Potencia/Power	Presión/Pressure	Capacidad/Capacity	Capacidad/Capacity	Dimensiones/Sizes	Peso/Weight
69428	220-240 V ; 50/60 Hz	1550 W	20 bar	2,80 L (depósito agua)	250 g (depósito café)	31x34,5x41,5 cm	8,00 Kg

INOX

Cafeteras



Disponen de válvula de seguridad
They have a safety valve



ES

- Cafetera italiana fabricada en acero inoxidable 18/10 de gran calidad y máxima resistencia.
- Boquilla en pico para servir directamente sin derramar ni una sola gota.
- Máxima seguridad garantizada: dispone de válvula de seguridad y asa termorresistente.
- 100% hermético gracias a su junta de cierre de silicona.
- Alta conductividad térmica.
- Capacidad para 4/6/10 tazas de café.
- Fondo FULL INDUCTION: apta para todo tipo de fuegos, incluida la inducción.
- Muy fácil de limpiar: apta para el lavavajillas.

FR

- Cafetière italienne fabriquée en acier inoxydable 18/10 de grande qualité et d'une résistance maximale.
- Bec verseur en pointe pour servir directement sans renverser une seule goutte.
- Sécurité maximum garantie : dispose d'une soupape de sécurité et d'une anse thermorésistante.
- 100% hermétique grâce à son joint de fermeture en silicone.
- Haute conductivité thermique.
- Capacité pour 4/6/10 tasses de café.
- Fond FULL INDUCTION : apte pour tout type de cuisinières, y compris l'induction.
- Très facile à nettoyer : apte pour le lave-vaisselle.

EN

- Moka pot made of high quality and extremely strong 18/10 stainless steel.
- Pointed spout for serving the coffee without spilling a drop.
- Guaranteed maximum safety: pressure valve and heat resistant handle.
- 100% Hermetic because of the silicone seal.
- High thermal conductivity.
- Capacity for 4/6/10 cups of coffee.
- FULL INDUCTION bottom: suitable for all kinds of cookers, including induction.
- It's very easy to clean and dishwasher safe.



Acabado BRILLO
GLOSS finish

Cafetera express MILAN

Cafetière express · Espresso Kocher
Express coffee pot · Cafeteira expresso

Ref	€	Tazas	Ø Base (cm)	h (cm)	U.Venta
62033	21,50	4	8,0	16,0	1
62036	25,10	6	9,0	19,5	1
62031	31,30	10	10,0	21,0	1



Acabado BRILLO
GLOSS finish

Cafetera express SIENA

Cafetière express · Espresso Kocher
Express coffee pot · Cafeteira expresso

Ref	€	Tazas	Ø Base (cm)	h (cm)	U.Venta
62124	48,60	4	8,5	18,0	1
62126	58,70	6	9,0	18,5	1
62121	70,20	10	10,5	21,5	1

Asa abatible y pomo de baquelita
Folding handle and Bakelite knob



Infusiona café molido con agua y consigue un café de gran sabor y aroma
Water and ground coffee infuse to make a coffee with great taste and aroma

Acabado BRILLO
GLOSS finish

Cafetera PAVA

Cafetière pava · Kaffeekanne Pava
Coffee pot · Chaleira

Ref	€	Ø Base (cm)	L	U.Venta
68215	34,70	10,0	1,00	1
68225	41,80	13,5	2,00	1
68235	51,00	15,0	2,80	1
68205	58,70	16,0	4,00	1



Acabado MATE
SATIN finish

Cafetera express HYPERLUXE

Cafetière express · Espresso Kocher
Express coffee · Cafeteira café expresso

Ref	€	Tazas	U.Venta
62074	80,40	4	1
62076	88,80	6	1
62071	101,50	10	1



Acabado BRILLO
GLOSS finish

Cafetera express LUXE

Cafetière express · Espresso Kocher
Express coffee · Cafeteira café expresso

Ref	€	Tazas	U.Venta
62084	65,80	4	1
62086	76,80	6	1
62081	90,70	10	1



Acabado BRILLO
GLOSS finish

Cafetera express MOKA

Cafetière express · Espresso Kocher
Express coffee pot · Cafeteira expresso

Ref	€	Tazas	ml	U.Venta
62054	55,00	4	200	1
62056	63,00	6	310	1
62051	74,70	10	500	1

ALUMINIO

Cafeteras



ES

- Cafetera italiana fabricada en aluminio fundido de gran calidad y máxima resistencia.
- Máxima seguridad garantizada: dispone de válvula de seguridad y asa de baquelita (Turin) / asa de madera de Haya (Trento) termorresistente.
- 100% hermético gracias a su junta de cierre de silicona.
- Alta conductividad térmica.

FR

- Cafetières italienne fabriquées en fonte d'aluminium de grande qualité et d'une résistance maximale.
- Sécurité maximum garantie : dispose d'une soupape de sécurité et d'une anse en bakélite (Turin) / anse en bois de hêtre (Trento) thermorésistante.
- 100% hermétique grâce à son joint de fermeture en silicone.
- Haute conductivité thermique.

EN

- Moka pot coffee maker made of high quality and very strong cast aluminium.
- Guaranteed maximum safety: pressure valve and heat resistant bakelite handle (Turin) / beech wood handle (Trento).
- 100% Hermetic because of the silicone seal.
- High thermal conductivity.



Cafetera express TURIN

Cafetière express · Espressoemaker
Express coffee pot · Cafeteira expresso

Ref	€	Tazas	Ø Base (cm)	h (cm)	U.Venta
62026	16,90	6	9,5	19,0	1
62029	21,10	9	10,5	21,5	1
62022	23,30	12	12,0	25,0	1



Cafetera express TRENTO

Cafetière express · Espressoemaker
Express coffee pot · Cafeteira expresso

Ref	€	Tazas	Ø Base (cm)	h (cm)	U.Venta
62046	29,90	6	8,5	20,0	1
62048	38,10	9	9,0	22,5	1
62096	29,90	6	8,5	20,0	1
62099	38,10	9	9,0	22,5	1

FRANCESAS

Cafeteras



ES

- Cafeteras clásicas manuales.
- Fabricadas en vidrio borosilicato, superresistentes a los cambios de temperatura.
- Filtro robusto de acero inoxidable 18/10; asegura una buena textura y sabor.
- Boquilla en pico para servir directamente sin derramar ni una sola gota.
- Forma práctica y sencilla de preparar los mejores cafés e infusiones en pocos minutos.

FR

- Cafetières classiques manuelles.
- Fabriquées en verre borosilicate, super résistant aux changements de température.
- Filtre robuste en acier inoxydable 18/10 ; garantit une texture et un goût excellents.
- Bec verseur pour servir directement sans renverser pas une seule goutte.
- Façon pratique et simple de préparer les meilleurs cafés et infusions en quelques minutes seulement.

EN

- Traditional manual coffee maker.
- Made of borosilicate glass, extremely resistant to temperatures changes. · High strength stainless steel 18/10 filter that ensures good flavour and texture.
- Spout nozzle to serve directly without spill not a single drop.
- An easy and practical way to make the best coffee and tea in just a few minutes.



Cafetera francesa

Cafetière à piston · Französische kaffemaschine
French coffee maker · Cafeteira francesa

Ref	€	Tazas	L	U.Venta
62173	19,10	3	0,35	1
62178	26,10	6	0,80	1
62183	8,30	3	0,35	6
62186	12,80	6	0,80	1



Cafetera francesa WOOD

Cafetière à piston · Französische kaffemaschine
French coffee maker · Cafeteira francesa

Ref	€	Tazas	L	U.Venta
62163	10,90	3	0,35	1
62168	14,60	6	0,80	1
62161	15,10	8	1,00	1



Cafetera de cristal

Cafetière en verre · Glaskaffeemaschine
Coffee pot w/glass · Cafeteira vidro

Ref	€	Tazas	L	U.Venta
62153	29,60	2	0,35	1
62180	42,00	6	0,80	1

CLASSIC

Colección

Inox 18/10
Dishwasher



Tetera
Théière · Teekanne
Tea pot · Bule

Ref	€	L	U.Venta
62023	18,90	0,23	12
62035	21,00	0,35	12
62060	28,60	0,60	6
62010	35,10	1,00	1



Cafetera
Cafetière · Kaffeekanne
Coffee pot · Cafeteira

Ref	€	L	U.Venta
62135	22,90	0,35	6
62160	30,80	0,60	6
62110	34,10	1,00	6
62115	47,60	1,50	1
62120	54,80	2,00	1



Lechera
Cremière · Milchkanne
Creamer · Leiteira

Ref	€	L	U.Venta
62215	8,80	0,15	6
62225	14,00	0,25	6
62235	14,70	0,35	6
62260	17,20	0,60	6
62210	21,50	1,00	6
62216	33,40	1,50	6
62220	39,80	2,00	6

Azucarero
Sucrier · Zuckerdose
Sugar bowl · Açucareiro

Ref	€	L	U.Venta
A 62001	16,00	0,23	6
B 62003	20,70	0,35	1



LUXE

Colección

Inox 18/10
Dishwasher



Tetera
Théière · Teekanne
Tea pot · Bule

Ref	€	L	U.Venta
65025	37,80	0,25	1
65035	40,00	0,35	1
65060	47,20	0,60	1
65012	59,40	1,20	1



Cafetera
Cafetière · Kaffeekanne
Coffee pot · Cafeteira

Ref	€	L	U.Venta
65135	39,40	0,35	1
65160	47,10	0,60	1
65110	59,80	1,00	1



Lechera
Cremière · Milchkanne
Creamer · Leiteira

Ref	€	L	U.Venta
65215	14,30	0,15	6
65235	24,50	0,35	6
65260	29,50	0,60	6

CAPUCCINO

Batidor

ABS plastic
SAN plastic
Dishwasher
BPA free



Varillas Inox
Rods Inox

Batidor capuccino
Batteur pour cappuccino · Capuccino-Mixer
Capuccino mixer · Batedor capuccino

Ref	€	W	U.Venta
69041	26,70	2,7	1

Incluye: Vaso medidor
Base para guardar el batidor y varillas
Varilla agitadora
Varilla para espumar
Batidor
Mezclador

Includes: Measuring cup
Base to store the whisk and rods
Stirring rod
Frothing rod
Whisk
Mixer

LECHERAS

Colección

Inox 18/10
Dishwasher

ES

- Ideales para bares, cafeterías, hoteles, restaurantes, hogares, etc.
- Fabricadas en acero inoxidable de máxima calidad, resistente y duradera.
- Pueden utilizarse tanto para líquidos calientes como fríos.
- Perfectas para espumar, calentar y servir la leche con el té o café.
- Boquilla vertedora para evitar goteos y un mango resistente al calor.
- Diseñadas para soportar altas temperaturas.
- Aptas para el lavavajillas.

FR

- Idéal pour les bars, les cafétérias, les hôtels, les restaurants, pour un usage domestique, etc.
- Fabriqué en acier inoxydable de la plus grande qualité, résistant et durable.
- Peut être utilisé aussi bien pour des liquides chauds que froids.
- Parfait pour mousser ou réchauffer et servir le lait avec le thé ou le café.
- Bec verseur anti-goutte et manche résistant à la chaleur.
- Conçu pour supporter de hautes températures.
- Aptes pour le lave-vaisselle.

EN

- Ideal for bars, cafés, hotels, restaurants, homes, etc.
- Manufactured in high-quality, strong and durable stainless steel.
- Can be used for both hot and cold liquids.
- Perfect for frothing or heating and serving milk with tea or coffee.
- Pouring spout to prevent dripping and heat-resistant handle.
- Designed to withstand high temperatures.
- Dishwasher safe.



Lechera
Pot crémier · Milchkanne
Milk jug · Leiteira

Ref	€	Color	L	e (mm)	U.Venta
A 58151	13,50	GREY	0,35	1	1
58152	16,10	GREY	0,60	1	1
B 58251	13,50	RED	0,35	1	1
58252	16,10	RED	0,60	1	1

Lechera barista
Pot crémier pour baristas · Milchkanne für Baristas
Barista milk jug · Leiteira barista

Ref	€	Color	L	e (mm)	U.Venta
A 58050	28,40	INOX	0,50	1	1
B 58150	31,30	GREY	0,50	1	1
C 58250	31,30	RED	0,50	1	1

TETERA HIERRO

Colección



ES

- Teteras fabricadas artesanalmente en hierro fundido de alta calidad muy resistentes.
- Incluyen infusor extraíble de acero inoxidable.
- Interior esmaltado para evitar la oxidación.
- Se recomienda hacer uso de un hervidor para calentar el agua y evitar así que pierda el color.

FR

- Thière fabriquée artisanalement en fonte d'aluminium de grande qualité, très résistante.
- Inclut un infuseur extractible en acier inoxydable.
- Intérieur émaillé pour éviter l'oxydation.
- Il est recommandé d'utiliser une bouilloire pour faire chauffer l'eau et ainsi éviter que la thière ne perde sa couleur.

EN

- This is a high quality, very resistant hand-made, cast iron tea pot.
- Includes a removable, stainless steel infuser.
- Interior is enameled to avoid rusting.
- It's recommended using a boiler to heat the water and thus keep it from losing its colour.

Red



White



Bamboo



Black



Green



Brown



Blue



Tetera
Thière · Teekanne
Tea pot · Bule

Ref	€	L	Color	U.Venta
68663	29,30	0,25	Red	1
68667	39,20	0,50	White	1
68666	32,70	0,60	Bamboo	1
68664	47,70	0,70	Black	1
68662	43,70	0,80	Green	1
68668	35,90	0,80	Brown	1
68661	40,50	1,10	Blue	1

HERVIDOR SILVANTE

Colección



ES

- Alto nivel de calidad y resistencia.
- Apto para hervir agua o calentar café preparado.
- Emite un ligero silbido cuando el agua hierve.

FR

- Haut niveau de qualité et de résistance.
- Apte pour faire bouillir de l'eau et réchauffer du café préparé.
- Émet un léger sifflement lorsque l'eau bout.

EN

- High level of quality and resistance.
- Suitable for boiling water or heating prepared coffee.
- Emits a gentle whistle when the water comes to the boil.



Hervidor silbante

Bouilloire sifflante · Flötenwasserkessel
Whistling kettle · Chaleira com apito

Ref	€	L	U.Venta
68619	37,40	2,00	1
68627	39,40	2,50	1
68629	41,90	3,00	1
68639	43,30	4,00	1
68643	46,40	2,50	1
68644	46,40	2,50	1

AGUA CALIENTE

Dispensador



ES

- Ideal para oficinas, casas rurales, reuniones, etc.
- Fácil llenado. Depósito extraíble de gran capacidad (2 L) para llenar fácilmente el contenedor.
- Display intuitivo. Elige la cantidad de agua (150 ml - 230 ml- 300 ml) y la temperatura deseada (25°C - 70°C - 85°C - 95°C).
- Cuenta con función de bloqueo de seguridad.
- Ahorra tiempo y energía. Proporciona la cantidad exacta de agua caliente deseada, el agua restante del depósito se mantendrá fría.
- Bandeja de goteo extraíble e imantada, fácil de limpiar y colocar.

FR

- Idéal pour les bureaux, les gîtes ruraux, les réunions, etc.
- Remplissage facile. Réservoir extractible de grande capacité (2 L) pour remplir facilement le conteneur.
- Écran intuitif. Choisissez la quantité d'eau (150 ml - 230 ml- 300 ml) et la température souhaitée (25°C - 70°C - 85°C - 95°C).
- Dispose d'une fonction de blocage de sécurité.
- Gain de temps et économies d'énergie. Fournit la quantité exacte d'eau chaude souhaitée, l'eau restant dans le réservoir restera froide.
- Plateau d'écoulement extractible et aimanté, facile à nettoyer et à installer.

EN

- Perfect for offices, country homes, meetings, etc.
- Easy to fill. Large capacity (2 L) removable tank to easily fill the container.
- Intuitive display. Choose the amount of water (150 ml - 230 ml- 300 ml) and the desired temperature (25°C - 70°C - 85°C - 95°C).
- Includes safety lock feature.
- Save time and energy. Provides the exact amount of hot water desired, while the remaining water in the tank remains cold.
- Removable and magnetic drip tray, easy to clean and replace.

Agua caliente en 5 segundos
Hot water in 5 seconds

Bandeja de goteo extraíble e imantada
Removable and magnetic drip tray

Dispensador de agua caliente
Distributeur d'eau chaude · Heißwasserspender
Hot water dispenser · Dispensador de água quente

Ref	€	W	U.Venta
69298	124,50	2400	1

Ref	Tensión/Voltage	Potencia/Power	Capacidad/Cap.	Niveles Calentamiento Heating levels	Dispensado agua Water dispensed	Dimensiones/Sizes	Peso/Weight
69298	220-240 V / 50-60 Hz	2400 W	2,00 L	25°C - 70°C - 85°C - 95°C	150-230-300 ml	32x16,8x32,7 cm	2,50 Kg

HERVIDORES DE AGUA

Colección



ES

- Hervidor de agua retro fabricado en acero inoxidable 18/10, acabado en gris mate.
- Permite calentar el agua de manera rápida y eficiente.
- Botón luminoso de encendido/apagado.
- Base independiente rotativa de 360°.
- Control STRIX, vida útil superior al controlador estándar. Protección contra el calentamiento en vacío muy preciso. Apagado automático.
- Visor de nivel de agua. Boquilla con filtro. Mango termorresistente.

FR

- Bouilloire rétro fabriquée en acier inoxydable 18/10, finition gris mat.
- Permet de chauffer l'eau de façon rapide et efficace.
- Bouton lumineux de marche/arrêt.
- Base indépendante rotative à 360°.
- Contrôle STRIX, durée de vie utile supérieure au contrôleur standard. Protection contre la chauffe à vide très précis. Arrêt automatique.
- Visualisation du niveau d'eau. Buse avec filtre. Poignée thermo-résistant.

EN

- Retro kettle made of 18/10 stainless steel with a matte grey finish.
- It can be used to heat water quickly and efficiently.
- Illuminated on/off button.
- Independent base rotates 360°.
- STRIX controller: useful life longer than a standard controller. Very precise protection against heating while empty. Automatic Shut-off.
- Water level viewer. Nozzle with filter. Heat-resistant handle.



Base independiente rotativa de 360°
Independent base rotates 360°



Botón luminoso de encendido/apagado
Illuminated on/off button



Fácil llenado
Easy filling



Interior inox 18/10
Interior 18/10 st. steel



Boquilla con filtro
Nozzle with filter



Indicador de nivel de agua
Water level indicator



Hervidor de agua RETRO

Bouilloire électrique · Elektrische Wasserwamer
Electric kettle · Chaleira eléctrica

Ref	€	W	L	U.Venta
69397	58,20	2200	1,7	1

Ref	Tensión/Voltage	Potencia/Power	Capacidad/Capacity	Dimensiones/Sizes	Peso/Weight
69397	220-240 V ; 50/60 Hz	2200 W	1,70 L	26x19,5x26,5 cm	1,20 Kg

Strix
Technology



Filtro extraíble anticál
Removable anti-cal filter



Visor de nivel de agua
Water level

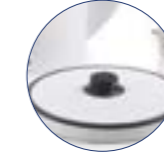

Base rotativa de 360°
360° rotating base



Calefactor oculto
Hidden heater



Hervidor de agua

Bouilloire · Wasserwamer
Kettle · Chaleira

Ref	€	Color	W	L	U.Venta
A 69590	22,60	GREY	2200	1,30	1
B 69591	22,60	WHITE	2200	1,30	1

Se desactiva cuando alcanza el nivel de temperatura deseada
It is deactivated when it reaches the desired temperature level

Ref	Tensión/Voltage	Potencia/Power	Capacidad/Capacity	Dimensiones/Sizes	Peso/Weight
69590	220-240 V; 50/60 Hz	2200 W	1,30 L	20x15x21 cm	0,74 Kg
69591	220-240 V; 50/60 Hz	2200 W	1,30 L	20x15x21 cm	0,74 Kg

Strix
Technology



Hervidor de agua LAKE

Bouilloire · Wasserwamer
Kettle · Chaleira

Ref	€	W	L	U.Venta
69277	59,70	2200	1,70	1

Ref	Tensión/Voltage	Potencia/Power	Capacidad/Capacity	Dimensiones/Sizes	Peso/Weight
69277	220-240 V; 50/60 Hz	2200 W	1,70 L (5 min)	23x16x23 cm	1,00 Kg
69291	220-240 V; 50/60 Hz	1630 W	1,00 L (3 min)	22x16x21 cm	1,10 Kg
69297	220-240 V; 50/60 Hz	2200 W	1,70 L (5 min)	22x18x23 cm	1,65 Kg



Hervidor de agua RAPID

Bouilloire · Wasserwamer
Kettle · Chaleira

Ref	€	W	L	U.Venta
69291	39,80	1630	1,00	1
69297	49,70	2200	1,70	1

Protección de ebullición en seco
Dry boil protection



Hervidor de agua
Bouilloire · Wasserwamer
Kettle · Chaleira

Ref	€	W	L	U.Venta
69292	80,70	2200	1,70	1

- Base para conector de 360°.
- Se apagará automáticamente cuando el agua hierve.
- Elemento de calefacción oculto.
- Indicador de luz de encendido/apagado.
- La temperatura se puede ajustar de 50°C-95°C.
- Almacenamiento de cable.

- Base pour connecteur de 360°.
- S'éteint automatiquement lorsque l'eau bout.
- Élément de chauffe caché.
- Indicateur lumineux de marche / arrêt.
- La température peut être réglée entre 50°C et 95°C.
- Rangement du câble.

- Base for 360° connector.
- The wireless boiler will automatically switch off when the water boils.
- Hidden heating element.
- ON/OFF light.
- The temperature can be adjusted from 50°C - 95°C.
- Cable storage.



Ref	Tensión/Voltage	Potencia/Power	Temperatura/Temp.	Capacidad/Capacity	Dimensiones/Sizes	Peso/Weight
69292	220-240 V; 50 Hz	2200 W	50 - 95°C	1,70 L	23x23x32 cm	1,90 Kg



- Cuerpo cerámico, ecológico y resistente a altas temperaturas.
- Base independiente rotativa de 360°.
- Tapa extraíble con cierre.
- Indicador de capacidad máxima.
- Interruptor de encendido/apagado luminoso.
- Protección de sobrecalentamiento y funcionamiento en seco.
- Función de apagado automático.

- Corps céramique, écologique et résistant aux températures élevées.
- Base indépendante rotative à 360°.
- Couvercle extractible avec fermeture.
- Indicateur de capacité maximale.
- Interrupteur de marche/arrêt lumineux.
- Protection contre la surchauffe et fonctionnement à sec.
- Fonction d'arrêt automatique.

- Ceramic body, ecological and resistant to high temperatures.
- 360° rotating independent base.
- Removable lid with closure.
- Maximum capacity indicator.
- Light up on/off switch.
- Protection from overheating and dry running.
- Auto-off function.



Interior inox 18/10. Calentamiento rápido
Interior 18/10 st. steel. Fast heating



Hervidor de agua cerámico

Bouilloire en céramique · Keramik Wasserwarmer
Ceramic kettle · Chaleira cerâmica

Ref	€	Nombre	W	L	U.Venta
A 69276	51,70	GALA	1500	1,20	1
B 69289	56,50	GALA GREY	1200	1,00	1

Ref	Tensión/Voltage	Potencia/Power	Capacidad/Capacity	Dimensiones/Sizes	Peso/Weight
69276	220-240 V; 50/60 Hz	1500 W	1,2 L	24x17x25 cm	1,68 Kg
69289	220-240 V; 50/60 Hz	1200 W	1,0 L	23x16,5x23 cm	1,40 Kg

Termos - Botellas
Thermos - Bottles

POLIPROPILENO

Jarras termo



ES

- Jarras termo que mantienen los líquidos calientes y fríos durante horas.
- Ideales para servir café, leche o té.
- Cuerpo de polipropileno, ligero y muy cómodo.
- Doble pared con una capa de vidrio en el interior que proporciona un alto rendimiento térmico.
- Tapa aislante de rosca con botón de apertura que mantiene el calor y dispensa fácilmente las bebidas.

FR

- Pichet isotherme qui maintient les liquides chauds et froids pendant des heures.
- Idéales pour servir le café, lait ou le thé.
- Corps en polypropylène, léger et très pratique.
- Double paroi avec ampoule en de verre à l'intérieur qui confère un haut rendement thermique.
- Couvercle isolant à vis avec poussoir d'ouverture qui maintient la chaleur et distribue facilement les boissons.

EN

- Thermos jug that keeps liquids hot and cold for hours.
- Ideal for coffee, milk or tea.
- Polypropylene body, light and very comfortable.
- Double skin with a glass layer inside to provide high thermal performance.
- Insulated screw cap with opening button for easy pouring and to keep the heat in the jug.



- Tapa aislante con pulsador.
- Irrompible, libre de malos olores.
- Fabricado en resina especial para soportar los golpes.
- Insulating lid with button.
- Shatterproof, free of bad smells.
- Manufactured in special resin to resist bangs.



Jarra termo WOOD

Pichet thermo · Thermoskanne
Termo jug · Jarra termo

Ref	€	cm	L	U.Venta
A 62598	22,10	Ø13x25,3	1,00	1
B 62599	22,10	Ø13x25,3	1,00	1



Jarra termo

Pichet thermo · Thermoskanne
Termo jug · Jarra termo

Ref	€	Color	L	U.Venta
A 62563	14,90	GREY	1,00	1
62564	17,00	GREY	1,50	1
62575	14,70	WHITE	1,00	1
B 62579	17,00	WHITE	1,50	1

Jarra termo PUSH

Pichet thermo · Thermoskanne
Termo jug · Jarra termo

Ref	€	L	U.Venta
62496	27,10	0,60	1
62491	38,80	1,20	1
62492	48,80	2,00	1

Triple pared aislante
Triple insulating wall

INOX 18/10

Jarras termo



ES

- Jarras termo que mantienen los líquidos calientes y fríos durante horas.
- Ideales para servir café, leche o té.
- Interior y exterior en acero inoxidable de gran calidad.
- Doble pared que proporciona un alto rendimiento térmico.
- Boca amplia; facilita su llenado y su limpieza.
- Tapa aislante de rosca con botón de apertura que mantiene el calor y dispensa fácilmente las bebidas.

FR

- Pichet isotherme qui maintient les liquides chauds et froids pendant des heures.
- Idéales pour servir le café, lait ou le thé.
- Intérieur et extérieur en acier inoxydable de grande qualité.
- Double paroi qui confère un haut rendement thermique.
- Bec large : facilite son remplissage et son nettoyage.
- Couvercle isolant à vis avec poussoir d'ouverture qui maintient la chaleur et distribue facilement les boissons.

EN

- Thermos jug that keeps liquids hot and cold for hours.
- Ideal for coffee, milk or tea.
- High-quality stainless steel interior and exterior.
- Double wall that provides high thermal performance.
- Wide mouth makes it easy to fill and clean.
- Insulated screw cap with opening button for easy pouring and to keep the heat in the jug.



Jarra termo SUITE

Verseuse isothermo · Thermoskanne, idoliert
Vacuum flask · Servidor termo

Ref	€	L	U.Venta
62522	49,90	1,6	1
62523	55,00	2,2	1



Jarra termo QUICK

Bouteille thermo · Thermoskanne
Insulated server · Jarra termo Luxe

Ref	€	L	U.Venta
62430	55,70	0,30	1
62460	61,70	0,60	1
62410	68,20	1,00	1
62415	87,90	1,50	1

Termo Hermético
Hermetic cap



Jarra termo LUXE

Bouteille thermo · Thermoskanne
Insulated server · Jarra termo

Ref	€	L	U.Venta
63360	67,00	0,60	1
63310	72,90	1,00	1
63315	84,20	1,50	1
63320	89,80	2,00	1



Jarra termo WHITE & BLACK

Verseuse isothermo · Thermoskanne, idoliert
Vacuum flask · Servidor termo

	Ref	€	Color	L	U.Venta
A	62483	31,20	Blanco / White	1,00	1
B	62484	31,20	Negro / Black	1,00	1



Jarra termo POT

Verseuse isothermo · Thermoskanne, idoliert
Vacuum flask · Servidor termo

	Ref	€	L	h (mm)	U.Venta
	62481	29,70	1,00	160	1
	62485	35,10	1,50	200	1
	62486	36,10	2,00	220	1

HINWEIS : In Deutschland nicht verfügbar

Boca ancha para cubitos hielo
Wide mouth for ice cubes



Doble pared
Double wall

Inox

Air pot

Air pot · Getränkespender, isoliert
Air pot · Air pot

	Ref	€	L	h (cm)	U.Venta
	62472	69,60	2,50	32,5	1
	62473	75,50	3,00	34,5	1
	62475	101,20	4,00	39,0	1



Termo BALA INOX

Thermo pour liquides · Thermobehälter für Flüssigkeiten
Thermo for liquids · Thermo para líquidos

	Ref	€	L	h (cm)	U.Venta
	62441	12,00	0,35	20,0	1
	62442	13,70	0,50	24,8	1
	62443	18,50	0,75	29,8	1
	62444	19,90	1,00	33,7	1

NO UTILIZAR CON BEBIDAS GASEOSAS, CALDOS NI LÁCTEOS

DO NOT USE WITH FIZZY DRINKS, BROTHS OR DAIRY



- Mantiene las bebidas calientes o frías durante 24 horas.
- Doble pared que proporciona un alto rendimiento térmico.
- Ligero e irrompible.
- Boca ancha para cubos de hielo.
- Fácil de abrir y cerrar. Fácil limpieza.

- Maintient les boissons chaudes ou froides pendant 24 heures.
- Double paroi qui confère un haut rendement thermique.
- Léger et incassable.
- Bec large pour glaçons.
- Ouverture et fermeture faciles. Facile a nettoyer.

- Keeps drinks hot or cold for 24 hours.
- Double wall that provides high thermal performance.
- Light and shatterproof.
- Wide mouth for ice cubes.
- Easy to open and close. Facile a nettoyer.



- Mantiene las bebidas calientes o frías hasta 24 horas.
- Doble pared y cámara de vacío.
- Alto rendimiento térmico.

- Maintient les boissons chaudes ou froides jusqu'à 24 heures.
- Haut rendement thermique.
- Double paroi et chambre à vide.

- Keeps drinks hot or cold up to 24 hours.
- High thermal efficiency.
- Double wall and vacuum chamber.

ALIMENTOS

Termo

Inox
18/10



ES

- Cierre hermético: tapa de rosca con junta de silicona para evitar derrames.
- Alto rendimiento térmico gracias a su doble pared y a la cámara de vacío del contenedor: mantiene la comida caliente hasta 6 horas y fría hasta 8 horas.
- Sistema de boca extra ancha: facilita el llenado y la toma de los alimentos.
- Revestimiento exterior en color mate antiralladura (62635/62636).
- Materiales atóxicos, 100% libres de BPA.

FR

- Fermeture hermétique : couvercle à vis avec joint en silicone pour éviter les écoulements.
- Haut rendement thermique grâce à sa double paroi et à la chambre à vide du conteneur : maintient la nourriture chaude jusqu'à 6 heures et froide jusqu'à 8 heures.
- Système d'ouverture extra large : facilite le remplissage et la récupération des aliments.
- Finition extérieure noire mate anti-rayures.
- Matériaux non toxiques, 100% sans BPA.

EN

- Airtight seal: screw lid with silicone gasket to prevent spillage.
- High thermal performance thanks to the container's double wall and vacuum chamber: it keeps food hot for up to 6 hours and cold for up to 8 hours.
- Extra wide mouth system: makes it easy to fill and eat food.
- Anti-scratch exterior coating in matt colour.
- 100% BPA free non-toxic materials.



Termo para alimentos FLORA

Thermo pour aliments · Thermobehälter für Speisen
Thermo for food · Thermo para alimentos

	Ref	€	Ø (cm)	h (cm)	L	U.Venta
A	62635	13,50	8,5	14,5	0,36	1
B	62636	23,60	10,5	15,0	0,50	1



Termo para alimentos INOX

Thermo pour aliments · Thermobehälter für Speisen
Thermo for food · Thermo para alimentos

	Ref	€	L	h (cm)	U.Venta
	62448	20,90	0,70	19,7	1
	62440	25,00	1,00	23,5	1



Termo para alimentos SOFT TOUCH

Thermo pour aliments · Thermobehälter für Speisen
Thermo for food · Thermo para alimentos

	Ref	€	h (cm)	L	U.Venta
	62480	52,10	18	1,50	1

BOTELLAS & VASOS

Colección



ES

- Fabricadas en acero inoxidable 18/10 de la mejor calidad.
- Doble pared de aislamiento, no transmiten el calor o el frío.
- Tapón de rosca hermético, a prueba de filtraciones y antiderrames.
- No transmiten sabores ni olores.
- Libres de BPA.

FR

- Fabriquées en acier inoxydable 18/10 de la plus grande qualité.
- Double paroi isolante, ne transmet ni la chaleur ni le froid.
- Bouchon à vis hermétique, anti écoulements.
- Ne transmettent ni les goûts ni les odeurs.
- Sans BPA.

EN

- Made of 18/10 stainless steel of the best quality.
- Double insulation wall, does not conduct heat or cold.
- Leak and spill proof hermetic screw on lid.
- Doesn't transmit flavours or odours.
- BPA free.

Acabado exterior con proceso de revestimiento en polvo
Outside finished with powder coating process



Botella inox EDAN

Bouteille inox · Stahlflasche
Stainless steel bottle · Garrafa de aço inoxidável

	Ref	€	L	U.Venta
	62536	11,10	0,26	1
A	62537	12,10	0,50	1
	62538	15,00	0,75	1
	62546	11,10	0,26	1
B	62547	12,10	0,50	1
	62548	15,00	0,75	1
	62584	11,10	0,26	1
C	62585	12,10	0,50	1
	62586	15,00	0,75	1
	62587	11,10	0,26	1
D	62588	12,10	0,50	1
	62589	15,00	0,75	1

Tapón de madera con anilla para colgar
Wood stopper with a ring for hanging



Botella inox FLORA

Bouteille inox · Stahlflasche
Stainless steel bottle · Garrafa de aço inoxidável

Ref	€	L	U.Venta
62556	14,10	0,50	1
62559	15,70	0,75	1



Botella termo infusora FLORA

Bouteille thermos avec infuseur · Thermo-Teebereiter
Infuser thermo bottle · Garrafa termo com infusor

Ref	€	Ø (cm)	h (cm)	ml	U.Venta
62534	15,30	6,6	21,5	350	1

Vaso SERVE & GO

Timbale · Trinkbecher
Tumbler · Copo

	Ref	€	Ø (cm)	h (cm)	ml	U.Venta
A	63138	14,60	9	14,0	280	1
B	63139	16,60	9	17,0	450	1

Tapón con doble protección a prueba de goteo
Drip proof double protected lid



Correa de transporte resistente
Strong carrying strap

Botella personal ENERGY

Personnelle bouteille · Persönliche Flasche
Personal bottle · Garrafa pessoal

Ref	€	L	U.Venta
61950	13,90	0,50	1
61965	15,10	0,65	1

- Fabricado en vidrio borosilicato de doble pared de máxima calidad.
- Filtro infusor de acero inoxidable 18/10 extraíble con asa que facilita la extracción.
- Cierre hermético: tapa de rosca fabricada en bambú con junta de silicona. Libre de BPA. 100% a prueba de fugas.
- Diseñado para hacer infusiones, té y bebidas frías.
- 100% sabor y aroma. No transmite olores ni sabores.
- Resistente al contraste térmico.
- Fácil limpieza: apto para el lavavajillas (excepto la tapa).

- Fabriquée en verre borosilicate à double paroi de la plus grande qualité.
- Filtre infuseur en acier inoxydable 18/10 extractible avec poignée qui facilite l'extraction.
- Fermeture hermétique : couvercle à vis fabriqué en bambou avec joint en silicone. Sans BPA. 100% anti-fuites.
- Conçue pour des infusions, du thé et des boissons froides. 100% goût et arôme.
- Ne transmet ni les odeurs ni les goûts.
- Résistante aux contrastes thermiques.
- Facile à nettoyer : apte pour le lave-vaisselle (sauf le couvercle).

- Made of the highest quality double-walled borosilicate glass.
- Removable 18/10 stainless steel infuser filter with handle for easy removal.
- Airtight closure: screw cap made of bamboo with silicone seal. BPA free. 100% leak proof.
- Designed to make herbal teas, teas and cold drinks.
- 100% flavor and aroma. Doesn't transmit aromas or flavors.
- Resistant to thermal contrast.
- Easy cleaning: dishwasher safe (except lid).

- Vaso reutilizable fabricado en vidrio borosilicato de gran espesor.
- Tapa de polipropileno con pestaña deslizante, libre de BPA.
- Cierre hermético; 100% a prueba de fugas.
- Banda de silicona antideslizante para un agarre seguro.
- Higiénico y resistente al contraste térmico.
- Diseñado para disfrutar de bebidas calientes o frías para llevar.
- No absorbe olores ni sabores.
- Fácil limpieza; apta para el lavavajillas.

- Verre réutilisable fabriqué en verre borosilicate de grande épaisseur.
- Couvercle en polypropylène avec bec coulissant, sans BPA.
- Fermeture hermétique ; 100% antifuites.
- Bande en silicone antidérapante pour une prise en main sûre.
- Hygiénique et résistant aux contrastes thermiques.
- Conçu pour profiter de boissons chaudes ou froides à emporter.
- N'absorbe ni les odeurs ni les goûts.
- Nettoyage facile ; apte pour le lave-vaisselle.

- This reusable glass is made of very thick borosilicate glass.
- It has a BPA free polypropylene lid with a sliding tab.
- Hermetic Seal: 100% leak proof.
- It has a non-slip silicone band for a secure grip.
- It's hygienic and resistant to thermal shock.
- It doesn't absorb odours or flavours.
- Easy to Clean: dishwasher safe.

FUNDAS

Colección

Tela **OEKO-TEX®** STANDARD 100
Cloth **FSC** **dishwasher**



ES

- Funda térmica; enfría y mantiene la temperatura durante más tiempo.
- Se adapta a todo tipo de botellas.
- Cubre prácticamente toda la botella, desde la base hasta al cuello.
- Meter la funda térmica en el congelador antes de su uso.
- El gel refrigerante no es tóxico.
- Para lavarlo, utilizar un paño húmedo. No apto para el lavavajillas.

FR

- Housse thermique qui permet de refroidir et de maintenir la température idéale du vin ou du cava pendant plus longtemps.
- S'adapte parfaitement à tout type de bouteilles.
- Couvre pratiquement toute la bouteille, de la base au goulot.
- Mettez le housse thermique dans le congélateur avant utilisation.
- Le liquide de refroidissement n'est pas toxique.
- Pour la laver, utiliser un chiffon humide. Ne pas mettre au lave-vaisselle.

EN

- Insulated cover for keeping wine or cava cool and at the perfect temperature for more time.
- Sides fit all kinds of bottles perfectly.
- It covers practically the whole bottle from the neck to the base.
- Put the thermal cover in the freezer before use.
- The coolant is non toxic.
- Use a damp cloth to clean it. Not dishwasher safe.



Funda enfriabotellas

Housse de refroidissement de bouteilles · Flaschenkühler
Bottle cooler cover · Arrefecedor de garrafas

	Ref	€	cm	Color	U.Venta
A	62276	14,70	15x23	DENIM	1
B	62277	14,70	15x23	BLACK	1
C	62270	14,70	15x23	BURDEOS	1
D	62288	14,30	15x23	NAVY	1



Funda enfriabotellas

Housse de refroidissement de bouteilles · Flaschenkühler
Bottle cooler cover · Arrefecedor de garrafas

	Ref	€	U.Venta
A	62325	10,60	6
B	62355	11,30	6

Bar - Bodega
Bar - Wine cellar

CUBITERAS

Colección



New



96
Cubitos
Ice cubes

32
Cubitos
Ice cubes

Cubitera de silicona flexible. Fácil de desmoldar
Flexible silicone ice cube tray Easy to unmould

Cubitera GLACIER

Bac à glaçon · Eismwürfelschale
Ice cube tray · Cuvete para gelo

Ref	€	Cubitos	Cubito (cm)	cm	h (cm)	U.Venta
63336	16,40	32	2,5x2,5x1,8	22,5x12	10,5	1

- Cubitera de hielo fabricada en silicona de grado alimenticio.
- Capacidad para hacer 32 cubitos de hielo 2,4x2,4x1,8cm de tamaño.
- Contenedor fabricado en polipropileno para almacenar hasta 96 cubitos.
- Evita que los hielos adquieran sabores u olores. Incluye 2 tapas para tapar la cubitera y el contenedor de manera simultanea.
- Gracias a su gran flexibilidad y prácticamente sin esfuerzo, podrás sacar los cubitos de forma rápida y sencilla.
- Libre de BPA.

- Bac à glaçons fabriqué en silicone alimentaire.
- Capacité pour faire 32 glaçons d'une taille de 2,4x2,4x1,8 cm.
- Conteneur fabriqué en polypropylène pour accueillir jusqu'à 96 glaçons.
- Évite aux glaçons de récupérer des goûts ou des odeurs. Inclut 2 couvercles pour fermer simultanément le bac à glaçons et le conteneur.
- Grâce à sa grande flexibilité, les glaçons pourront être retirés de façon rapide et simple, presque sans efforts.
- Sans BPA.

- Ice cube tray made of food grade silicone.
- Capacity for making 32 2.4x2.4x1.8 cm ice cubes.
- Container made of polypropylene for storing up to 96 ice cubes.
- Keeps the ice cubes from taking on flavours or odours. Includes 2 lids for covering the ice cube tray and the container at the same time.
- You can get the ice cubes out quickly and easily and almost effortlessly because it's extremely flexible.
- BPA free.

New

Orificio para un llenado fácil
Orifice for easy filling



16
Cubitos
Ice cubes



Cubitera FRESH

Bac à glaçon · Eismwürfelschale
Ice cube tray · Cuvete para gelo

Ref	€	Cubitos	Cubito (cm)	cm	h (cm)	U.Venta
63337	4,30	16	4,5x3x3	30x11,5	4,6	1

- Cubitera de hielo fabricada en polipropileno.
- Capacidad para hacer 16 cubitos de hielo.
- Evita que los hielos adquieran sabores u olores gracias a su tapa hermética.
- La tapa incluye un orificio para un llenado fácil sin derrames o salpicaduras.
- Libre de BPA.

- Bac à glaçons fabriqué en polypropylène.
- Capacité pour faire 16 glaçons
- Évite aux glaçons de récupérer des goûts ou des odeurs grâce à son couvercle hermétique.
- Le couvercle comprend un trou pour faciliter le remplissage sans renverser ou éclabousser.
- Sans BPA.

- Ice cube tray made of polypropylene.
- Capacity for making 16 ice cubes.
- Keeps the ice cubes from taking on flavours or odours thanks to its hermetic lid.
- The lid includes a hole for easy filling without spilling or splashing.
- BPA free.

New

Orificio para un llenado fácil
Orifice for easy filling



15
Cubitos
Ice cubes



Cubitera de silicona flexible. Fácil de desmoldar
Flexible silicone ice cube tray Easy to unmould

Cubitera ICE

Bac à glaçon · Eismwürfelschale
Ice cube tray · Cuvete para gelo

Ref	€	Cubitos	Cubito (cm)	cm	h (cm)	U.Venta
63338	8,50	15	3x3x2,5	20x11,5	3,5	1

- Cubitera de hielo fabricada en silicona.
- Capacidad para hacer 15 cubitos de hielo.
- Evita que los hielos adquieran sabores u olores gracias a su tapa hermética.
- La tapa incluye un orificio para un llenado fácil sin derrames o salpicaduras.
- Gracias a su gran flexibilidad y prácticamente sin esfuerzo, podrás sacar los cubitos de forma rápida y sencilla.
- Libre de BPA.

- Bac à glaçons fabriqué en silicone.
- Capacité pour faire 15 glaçons
- Évite aux glaçons de récupérer des goûts ou des odeurs grâce à son couvercle hermétique.
- Le couvercle comprend un trou pour faciliter le remplissage sans renverser ou éclabousser.
- Grâce à sa grande flexibilité, les glaçons pourront être retirés de façon rapide et simple, presque sans efforts.
- Sans BPA.

- Ice cube tray made of silicone.
- Capacity for making 15 ice cubes.
- Keeps the ice cubes from taking on flavours or odours thanks to its hermetic lid.
- You can get the ice cubes out quickly and easily and almost effortlessly because it's extremely flexible.
- The lid includes a hole for easy filling without spilling or splashing.
- BPA free.

New

6
Cubitos
Ice cubes



Cubitera de silicona flexible. Fácil de desmoldar
Flexible silicone ice cube tray Easy to unmould

Cubitera ICE XL

Bac à glaçon · Eismwürfelschale
Ice cube tray · Cuvete para gelo

Ref	€	Cubitos	Cubito (cm)	cm	h (cm)	U.Venta
63339	8,10	6	4,5x4,5x4,5	15,5x10,5	4,5	1

- Cubitera de hielo fabricada en silicona.
- Capacidad para hacer 6 cubitos de hielo XL.
- Mantienen las bebidas frías durante más tiempo.
- Gracias a su gran flexibilidad y prácticamente sin esfuerzo, podrás sacar los cubitos de forma rápida y sencilla.
- Libre de BPA.

- Bac à glaçons fabriqué en silicone.
- Capacité pour faire 6 glaçons XL.
- Garde les boissons plus froides plus longtemps.
- Grâce à sa grande flexibilité, les glaçons pourront être retirés de façon rapide et simple, presque sans efforts.
- Sans BPA.

- Ice cube tray made of silicone.
- Capacity for making 6 XL ice cubes.
- Keeps drinks cold for longer.
- You can get the ice cubes out quickly and easily and almost effortlessly because it's extremely flexible.
- BPA free.

ENFRIABOTELLAS INOX

Colección

Inox
18/10
Dishwasher



ES

- Amplia gama de enfriadores de botellas para el vino o champán.
- Fabricados en acero inoxidable de gran calidad.
- Ideal para uso doméstico y profesional.

FR

- Large gamme de rafraîchisseurs de bouteilles pour le vin ou le champagne.
- Fabriqué en acier inoxydable de haute qualité.
- Idéal pour un usage domestique et professionnel.

EN

- Wide range of bottle coolers for wine or champagne.
- Made of high quality stainless steel.
- Ideal for domestic and professional use.

Compatible con:
Compatible with:

62315
62320
62322
62321
61321
61319
14121
62365
62362
65418
65420
65618
65620

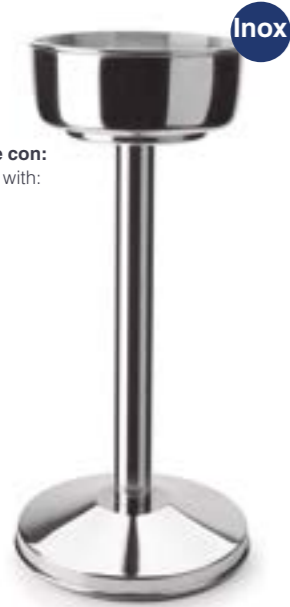

Pie porta-cubos

Porte-seau à champagne · Sektkühlerständer
Wine cooler stand · Pé porta baldes

Ref	€	Ø (cm)	h (cm)	U.Venta
62300	90,00	20	65	1

Sujeción segura y estable
en cualquier mesa
Secure and stable
hold on any table



Soporte de mesa enfriabotellas

Support seau à champagne · Tischhalterung für Sektkühler
Wine cooler table support · Suporte balde de gelo arrefecedor

Ref	€	Ø (cm)	U.Venta
62478	12,80	18	1
62479	12,90	20	1

Apta para la mayoría de las
botellas de vino o champán
Fits most bottles of red wine
or champagne

Doble pared aislante
Double insulating wall



Enfriabotellas INOX

Seau à champagne · Champagnerkühler
Champaing cooler · Arrefecedora de garrafas

Ref	€	Ø (cm)	h (cm)	U.Venta
62389	31,00	10,5	19,5	1

Doble pared aislante
Acabado SOFT TOUCH
Double insulating wall
SOFT TOUCH finish



Anilla de acero inoxidable
Stainless steel ring

Enfriabotellas BLACK

Seau à vin · Champagnerkühler
Vine bucket · Balde enfria-garrafas

Ref	€	Ø (cm)	Ø Int. (cm)	h (cm)	U.Venta
62356	16,50	12,5	9,50	20	1



garinox®

Cubitera

Seau à glace · Sektkühler
Ice bucket · Porta-cubos de gelo

Ref	€	Ø (cm)	h (cm)	L	U.Venta
62315	31,70	14	12,0	1,20	1
62320	43,10	20	19,0	4,50	1
62322	51,80	22	20,0	5,50	1
14121	19,20	20	20,0	4,00	1
62321	63,10	18	20,0	5,50	1
61321	24,60	20	21,0	4,25	1
61319	26,70	20	22,0	4,75	1



Champanero

Rafraîchisseur à champagne · Champagnerkühler
Champagne cooler · Champanheiro

Ref	€	Ø (cm)	h (cm)	L	U.Venta
62336	131,20	36	28,0	11,50	1
62436	121,30	36	23,0	11,50	1
62439	132,40	40	26,0	15,00	1
62346	86,00	36	20,5	13,00	1
62271	58,20	43x30	20,0	20,00	1
62272	70,10	53x38	25,0	27,00	1
62273	82,00	61x43	28,0	32,00	1

MOON

Colección

Inox
18/10

ES

- **Cuerpo de Acero inoxidable 18/10, resistente a la corrosión.**
- **Diseño elegante y actual.**
- **Muy cómodo y fácil de desplazar gracias a su asa de cuero.**
- **Asa de piel vacuno acabado en curtido vegetal de 3 mm de grosor.**
- **Acabado exterior negro mate e interior lijado o exterior e interior lijado.**

FR

- **Corps en acier inoxydable 18/10, résistant à la corrosion.**
- **Style élégant et actuel.**
- **Très pratique et facile à déplacer grâce à sa anse en cuir.**
- **Anse en peau de vachette avec un tannage végétal de 3 mm d'épaisseur.**
- **Finition extérieur noir mat et intérieur brossé ou extérieur et intérieur brossé.**

EN

- **18/10 corrosion resistant stainless steel body.**
- **It has an elegant and modern design.**
- **Leather handles make it very easy and comfortable to move around.**
- **The handle has a 3 mm thick vegetable-tanned cow leather finish.**
- **Matte black outside and brushed inside or brushed inside and outside.**



Cubitera MOON

Seau à glace · Sektkühler
Ice bucket · Porta-cubos de gelo

Ref	€	Ø (cm)	h (cm)	L	U.Venta
A 65414	40,00	14	12	1,5	1
B 65614	34,60	14	12	1,5	1



Enfriabotellas MOON

Seau à champagne · Champagnerkühler
Wine bucket · Arrefecedora de garrafas

Ref	€	Ø (cm)	h (cm)	L	U.Venta
A 65418	47,40	18	19,0	4,0	1
65420	56,60	20	19,5	5,6	1
65618	43,80	18	19,0	4,0	1
B 65620	52,60	20	19,5	5,6	1



Champanero MOON

Refräichisseur à champagne · Champagnerkühler
Champagne cooler · Champanheiro

Ref	€	Ø (cm)	h (cm)	L	U.Venta
A 65436	120,30	36	20,5	11,5	1
B 65636	120,30	36	20,5	11,5	1



Más visibilidad
y accesibilidad
More visibility
and accessibility



Champanero inclinado MOON

Refräichisseur à champagne incliné · Schräger Champagnerkühler
Inclined champagne cooler · Champanheiro inclinado

Ref	€	Ø (cm)	h (cm)	L	U.Venta
A 65440	119,10	40	27	15	1
B 65640	119,10	40	27	15	1



Barreño MOON

Bassine · Glattwanne
Mirror cooler · Bacia

Ref	€	Ø (cm)	h (cm)	L	U.Venta
A 65450	105,40	50	21	30	1
B 65650	105,40	50	21	30	1

ENFRIABOTELLAS ACRÍLICAS

Colección

ASA
Acrylic

Dishwasher

BPA free

Acabado metalizado
Metallic finish



ABS
Classic

Enfriabotellas ARTIC

Seau à champagne · Champagnerkühler
Champaging cooler · Arrefecedora de garrafas

Ref	€	Ø (cm)	h (cm)	L	U.Venta
61331	19,60	20	25	3,50	1



Enfriabotellas BOAT BLACK

Seau à champagne · Champagnerkühler
Champaging cooler · Arrefecedora de garrafas

Ref	€	Base	Boca	h (cm)	L	U.Venta
A 62354	33,40	13,5x16	20,5x25,5	28,5	4,00	1
62367	34,70	16x12	27x20	20,0	3,00	1
B 62368	50,00	21x15,5	35x26,5	26,0	7,00	1



Enfriabotellas

Seau à champagne · Champagnerkühler
Champaging cooler · Arrefecedora de garrafas

Ref	€	Base	cm	h (cm)	L	U.Venta
A 62364	18,00	16	22x18	23,0	3,00	1
B 62365	33,30	13,5x16	20,5x25,5	28,5	4,50	1
C 62366	40,00	13,5x18,5	21,5x30,5	26,0	5,50	1



Enfriabotellas BLOOM

Seau à champagne · Champagnerkühler
Champaging cooler · Arrefecedora de garrafas

Ref	€	Ø (cm)	h (cm)	L	U.Venta
A 62362	12,60	22	21	3,50	1
B 62371	28,80	33	25	10,00	1



Enfriabotellas BUBBLE

Seau à champagne · Champagnerkühler
Champaging cooler · Arrefecedora de garrafas

Ref	€	cm	h (cm)	L	U.Venta
62373	30,30	47x29	23	13,00	1

JARRAS

Colección



Jarra dispensadora

Pichet distributeur de boissons · Getränkespender
Serving pitcher · Jarra dispensadora

	Ref	€	cm	h (cm)	L	U.Venta
A	61951	22,20	18x23	30,5	5,50	1
B	61955	7,70	19,5	18,5	-	1
C	61956	13,20	21,0	14,5	-	1

- Jarra dispensadora fabricada en cristal de máxima calidad.
- Perfecta para bebidas frías como agua, limonada, zumo, sangría, etc.
- Grifo integrado para servir la cantidad de bebida deseada directamente en el vaso.
- Ideal para buffet, área de reuniones, recepciones de hoteles, etc.
- Gran apertura que facilita su llenado y su limpieza.
- Tapa de acero con cierre hermético.
- Jarra apta para el lavavajillas.

- Pichet distributeur de boissons fabriqué en verre de la plus grande qualité.
- Parfait pour des boissons froides comme de l'eau, de la limonade, du jus de fruits, de la sangria, etc.
- Robinet intégré pour servir la quantité de boisson souhaitée directement dans le verre.
- Idéal pour les buffets, les salles de réunions, les réceptions dans les hôtels, etc.
- Grande ouverture qui facilite son remplissage et son nettoyage.
- Couvercle en acier avec fermeture hermétique.
- Pichet compatible avec le lave-vaisselle.

- This serving pitcher is made of top quality glass.
- It's perfect for cold drinks like water, lemonade, juice or sangria.
- It has a built-in spout for pouring the right amount of the drink into a glass.
- It's perfect for buffets, meeting rooms, hotel reception areas, etc.
- Its large opening makes it easy to fill and clean.
- It has a steel lid with a hermetic seal.
- The pitcher is dishwasher safe.

Tapa antiderrames
Filtro infusor en el centro para frutas y verduras
Non-spill lid
Infusion filter in the centre for fruits and vegetables



Jarra infusora CLEAR

Pichet infuseur · Tee-Zubereiter
Infusion pitcher · Jarra infusionadora

Ref	€	cm	L	U.Venta
61954	30,80	19x16x29	2,40	1

- Desenroscar la tapa girándola en sentido anti-horario**
Dévisser le couvercle dans le sens inverse des aiguilles d'une montre
Unscrew the lid by turning it counter-clockwise
- Introducir la fruta, hierbas o semillas**
Mettre de fruit, les herbes ou les graines
Introduce the fruit, herbs or seeds
- Enroscar la tapa girándola en sentido horario**
Revisser le couvercle en le faisant tourner dans le sens des aiguilles d'une montre
Screw on the lid by turning it clockwise
- Introducir el filtro dentro de la jarra y presionar la tapa hasta cerrarla**
Introduire le filtre dans le pichet et appuyer sur le couvercle jusqu'à sa fermeture
Put the filter in the pitcher and push the lid until it's closed



Tapa con doble posición
Filtro-colador integrado en la tapa (2)
el hielo, las hierbas aromáticas
o la fruta es retenida en el vertido
Double position lid
Filter-strainer integrated in the lid (2).
Ice, aromatic herbs or fruit is held
in place while pouring

- Resistente a los choques térmicos.
- Perfecta para bebidas calientes o frías como limonadas, té, sangría, leche, etc.
- Ideal para llevar las bebidas a la mesa o guardarlas en la nevera.
- Diseño moderno y elegante.
- Mango ergonómico y pico vertedor para evitar derrames.
- Gran apertura que facilita su llenado y su limpieza.
- Cuerpo apto para el lavavajillas.

- Résistant aux chocs thermiques.
- Parfait pour les boissons chaudes ou froides comme la limonade, le thé, la sangria, le lait, etc.
- Idéal pour apporter les boissons à table ou les conserver au réfrigérateur.
- Design moderne et élégant.
- Manche ergonomique et bec verseur pour éviter les écoulements.
- Grande ouverture qui facilite son remplissage et son nettoyage.
- Corps compatible avec le lave-vaisselle.

- It's resistant to thermal shock.
- It's perfect for hot or cold drinks, like lemonade, tea, sangria or milk.
- It's ideal for bringing drinks to the table or keeping them in the refrigerator.
- It has a modern and elegant design.
- It has an ergonomic handle and spout to prevent spills.
- Its large opening makes it easy to fill and clean.
- The body is dishwasher safe.



Jarra

Pot à eau · Wasserkanne
Water jug · Jarra

	Ref	€	cm	h (cm)	L	U.Venta
A	61952	16,20	14x9,2	27,3	1,70	1
B	61953	15,00	13,8x8,5	22,8	1,00	1

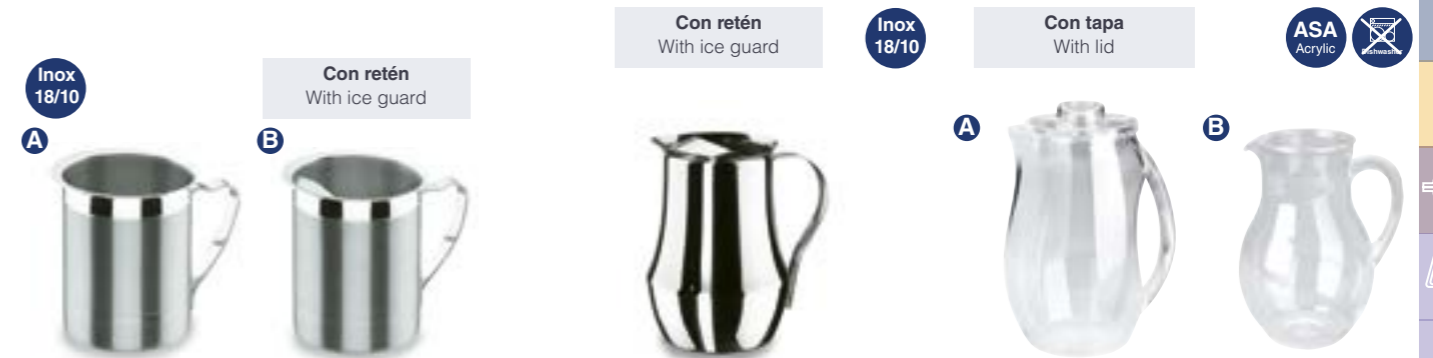

Jarra de agua INOX

Pot à eau · AcrylKrug
Water pitcher · Jarra

	Ref	€	Ø (cm)	L	U.Venta
	62716	25,30	12x16	1,50	1
A	62721	27,90	12x23	2,00	1
	62726	32,20	12x26,5	2,50	1
	62715	29,40	12x16	1,50	1
B	62720	30,70	12x23	2,00	1
	62725	34,70	12x26,5	2,50	1

Jarra de agua abombada

Pot à eau bombe · Wasserkanne
Rounder water pitcher · Jarra bojuda

Ref	€	L	U.Venta
62702	47,90	2,00	1

Jarra de agua CLEAR

Pot à eau · AcrylKrug
Water pitcher · Jarra

	Ref	€	L	U.Venta
A	62391	36,20	2,80	1
	62392	13,90	2,00	1
B	62393	17,60	3,00	1

VASOS TRITÁN

Colección



Aptas para todos los soportes de copas LACOR
Suitable for all LACOR cup holders



ES

- Fabricados en tritán transparente libre de BPA; material muy resistente que soporta altas temperaturas.
- Ligeros, versátiles y a prueba de roturas, perfectos para espacios exteriores donde la seguridad es importante.
- Su gran parecido visual al vidrio hace que sea sutil, elegante y de calidad, como un vaso de vidrio.
- Reutilizables, irrompibles y aptos para el lavavajillas.

FR

- Fabriqué en Tritan transparent sans bisphénol A; matériau très résistant qui supporte des températures élevées.
- Légers, versatiles et à l'épreuve de la casse, ils sont parfaits pour des espaces extérieurs où la sécurité est importante.
- Leur grande ressemblance visuelle avec le verre les rend subtils, élégants et de qualité, tel un authentique verre.
- Réutilisables, incassables et aptes pour le lave-vaisselle.

EN

- Manufactured in transparent BPA-free Tritan; high strength material that can withstand high temperatures.
- Lightweight, versatile and break-proof, perfect for outdoor areas where safety is important.
- With its subtle, elegant and quality material, it provides a great visual resemblance to glass.
- Reusable, unbreakable and dishwasher safe.



Set 6 vasos

Set 6 verres · Set 6 gläser
Set of 6 glasses · Conjunto de 6 copos

	Ref	€	Ø (cm)	h (cm)	ml	U.Venta	
A	63141	33,00	8,5	9,5	400	1	Whisky · Whisky
B	63142	58,20	8,0	22,5	700	1	Cerveza · Beer
C	63143	45,30	7,0	20,0	350	1	Vino blanco · White wine
D	63144	51,40	9,5	21,0	500	1	Vino tinto · Red wine
E	63145	66,80	8,5	14,5	500	1	Refresco · Soft drinks
F	63146	61,90	8,5	14,0	500	1	Cerveza · Beer
G	63147	48,90	8,0	10,0	350	1	Agua · Water
H	63148	35,00	6,5	11,0	300	1	Vaso para niño · Child glass
I	63149	51,00	4,5	22,5	150	1	Champán · Champagne

Vaso

Timbale · Trinkbecher
Tumbler · Copo

	Ref	€	Ø (cm)	h (cm)	L	U.Venta
A	63350	3,40	7,3	7,7	0,32	1
B	63351	3,40	7,3	7,7	0,32	1
C	62406	6,00	7,5	10,0	0,30	1



SOPORTE COPAS

Colección

FE Cromado

Hierro/Iron Chrome

ES

- Soporte que permite ahorrar espacio y almacenar las copas de forma ordenada.
- Se fija a la parte superior de un mueble, techo o cornisa permitiendo colocar las copas boca abajo y facilitando accesibilidad de las mismas.
- Desliza las copas muy fácilmente evitando que se marquen y que se rompan.

FR

- Support qui permet un gain de place et un rangement des verres à pied de façon ordonnée.
- Se fixe à la partie supérieure d'un meuble, d'un plafond ou d'une corniche, permettant ainsi de ranger les verres à pied vers le bas et faciliter leur accès.
- Fait glisser les verres très facilement en évitant qu'ils soient marqués et qu'ils se cassent.

EN

- With this rack, you can save space and store glasses in an organised way.
- It can be attached to the top of a piece of furniture, ceiling or moulding where the glasses are placed upside down for easy access.
- The glasses slide easily so they won't get scratched or broken.

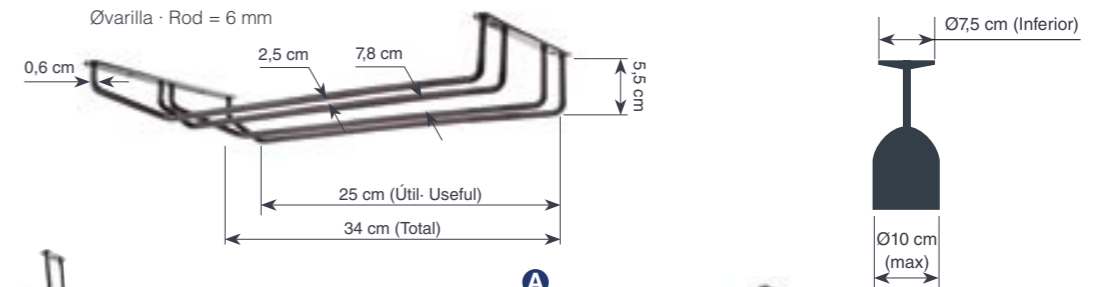

Soporte de copas

Support à coupes · Gläserhalter
Cups stand · Suporte de tapas

	Ref	€	cm	h (cm)	U.Venta
A	62261	14,90	34x10	6	1
B	62262	21,80	34x20	6	1
C	62263	33,50	34x40	6	1

Soporte de copas BLACK

Support à coupes · Gläserhalter
Cups stand · Suporte de tapas

	Ref	€	cm	h (cm)	U.Venta
A	62264	17,30	34x10	6	1
B	62265	26,60	34x20	6	1
C	62266	37,40	34x40	6	1

No requiere instalación
Recubrimiento de silicona, no raya
No installation required
Silicone coating, does not scratch



Øvarilla · Rod = 6 mm

Soporte de copas TRI

Support à coupes · Gläserhalter
Cups stand · Suporte de tapas

	Ref	€	cm	Copas	U.Venta
	62267	18,10	31x21	6	1

Fijado a la pared
Fastened to wall



Fijado al techo
Fastened to ceiling



Øvarilla · Rod = 6 mm

Soporte de copas DUE

Support à coupes · Gläserhalter
Cups stand · Suporte de tapas

	Ref	€	cm	h (cm)	U.Venta
	62268	18,70	45x32	6,0	1

COCTELERÍA

Colección

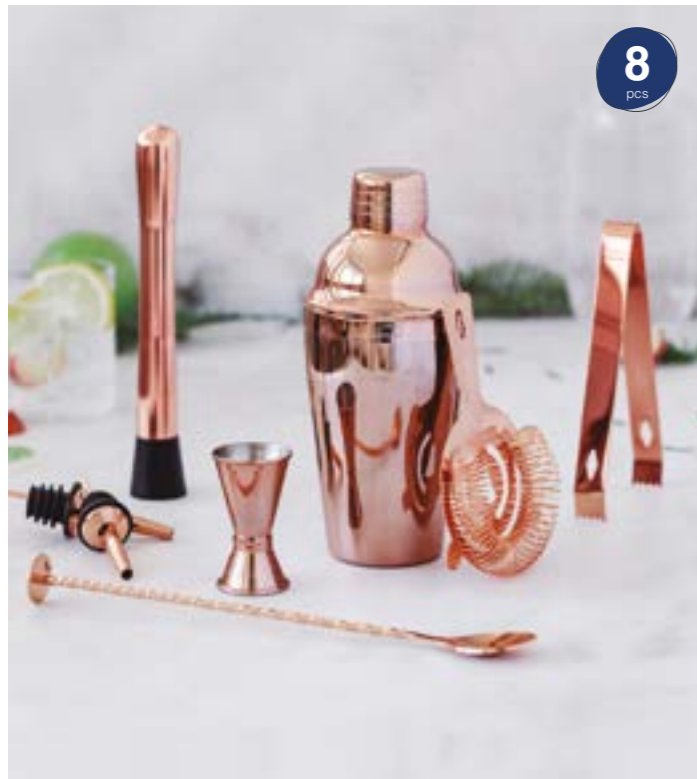

8
pcs



10
pcs

ES

- Todo lo necesario para preparar deliciosos cócteles.
- Ideal para profesionales de la coctelería.
- Podrá encontrar coctelera, pinzas para hielo, vasos medidores, cucharas de bar, etc.
- Fabricados en acero inoxidable de alta calidad.

FR

- Tout ce dont vous avez besoin pour préparer de délicieux cocktails.
- Idéal pour les mixologues professionnels.
- Vous pouvez trouver des shakers, pinces à glace, verres à mesurer, cuillères de bar, etc.
- Fabriqué en acier inoxydable de haute qualité.

EN

- Everything you need to prepare delicious cocktails.
- Ideal for professional mixologists.
- You can find cocktail shakers, ice tongs, measuring glasses, bar spoons, etc.
- Made of high quality stainless steel.

Compuesto por:

- A** Cucharilla cocktail
- B** Coctelera
- C** Maza mojito
- D** Colador gusanillo
- E** Sacacorchos
- F** Dosificador licor
- G** Pinza
- H** Tapón
- I** Dos boquillas servidoras
- J** Soporte

Compuesto por:

- A** Cucharilla cocktail
- B** Coctelera
- C** Maza mojito
- D** Colador gusanillo
- E** Pinza
- F** Dosificador licor
- G** Dos boquillas servidoras



Juego coctelería INOX

Ensemble pour cocktails · Cocktail-Utililien
Cocktail Set · Conjunto para preparar cocktails

Ref	€	Piezas	L (Coctelera)	ml (Medidor)	cm (Cuchara)	U.Venta
62181	59,80	10	0,55	15 / 30	26	1



Juego coctelería INOX COBRE

Ensemble pour cocktails · Cocktail-Utililien
Cocktail Set · Conjunto para preparar cocktails

Ref	€	Piezas	L (Coctelera)	ml (Medidor)	cm (Cuchara)	U.Venta
62182	56,00	8	0,55	15 / 30	26	1



Tapete para coctelería

Tapis pour égouttoir · Cocktail-Matte
Cocktail mat · Tapete para cocktails

	Ref	€	cm	h (cm)	U.Venta
A	62626	17,40	45x30	1,80	20
B	62627	10,70	30x15	1,80	20
C	62628	10,70	60x8	1,80	20



Perfecto para organizar utensilios y accesorios de coctelería y bar como servilletas, pajitas, adornos, etc.
Perfect for organising cocktail utensils and accessories and bar such as napkins, straws and decorations

Puede contener aproximadamente 100 servilletas de 12x12 cm
It holds around 100 12x12 cm cocktail napkins



Organizador de accesorios cóctel

Organisateur pour accessoires de cocktail · Organizer für Cocktailzubehör
Cocktail accessory organiser · Organizador de acessórios para cocktails

Ref	€	cm	h (cm)	Compartimentos	U.Venta
62438	9,40	24x14	10	6	1



Ideal para dar un toque especial a los cócteles.
Consigue un efecto de hielo o escarcha
Perfect for adding a special touch to your cocktails.
Create a frosty or icy effect

Se pliega para un fácil almacenamiento
Foldable for easy storage

Almohadilla para zumo
Pad for juice



Ribeteador de copas y vasos

Sucreur/saleur bordeur de verres · Umranden für Cocktailgläser
Glass rimmer · Decorador de copos e taças

Ref	€	cm	h (cm)	Bandejas	U.Venta
62414	13,90	20x16	7,5	3	1

New



Taza MOSCOW MULE

Tasse · Tassen
Cup · Copo

	Ref	€	Ø (cm)	h (cm)	ml	U.Venta
A	62184	10,00	9	9	480	1
B	62185	10,00	9	10	550	1

- Diseño vintage. Fabricada en acero inoxidable 18/10 de alta calidad. Revestimiento exterior cobre mate.
- Ideal para preparar el clásico coctel de vodka "Moscow Mule", cócteles o cualquier tipo de bebida frías.
- Mantiene las bebidas frías por más tiempo gracias a su alta conductividad térmica.
- Borde de acero encapsulado reforzado. Mango ergonómico fabricado en acero inoxidable.
- Fácil limpieza: Se recomienda lavar a mano y secar a fondo. No apto para el lavavajillas.

- Style vintage. Fabriqué en acier inoxydable 18/10 de grande qualité. Revêtement extérieur en cuivre mat.
- Idéales pour préparer le traditionnel cocktail de vodka « Moscow Mule », ainsi que tout type de cocktail ou de boisson froide.
- Gardent les boissons fraîches plus longtemps grâce à leur grande conductivité thermique.
- Bord en acier encapsulé renforcé. Manche ergonomique fabriqué en acier inoxydable.
- Nettoyage facile : Il est recommandé de les laver à la main et de parfaitement bien les sécher.
- Ne pas mettre au lave-vaisselle.

- Vintage design. Made of high quality 18/10 stainless steel. Matte copper outer finish.
- Perfect for making the classic "Moscow Mule" vodka cocktail, other cocktails or any kind of cold drink.
- Keeps drinks cold longer because of their high thermal conductivity.
- Reinforced encapsulated steel edge. Ergonomic handle made of stainless steel.
- Easy to clean: Hand washing and thorough drying is recommended. Not dishwasher safe.



Coctelera BOSTON

Agitateur · Cocktailshaker
Cocktail shaker · Agitador

	Ref	€	Ø (cm)	h (cm)	U.Venta
A	62285	13,90	8	16	1
B	62286	18,20	8	16	1



Coctelera INOX

Agitateur · Cocktailshaker
Cocktail shaker · Agitador

	Ref	€	L	U.Venta
	623031	50,80	0,50	1
	623041	60,30	0,75	1



Coctelera ACRYLIC

Agitateur · Cocktailshaker
Cocktail shaker · Agitador

	Ref	€	Ø (cm)	h (cm)	U.Venta
	62388	20,60	9	22,5	1

- Cuerpo fabricado en acero inoxidable de máxima calidad. Acabado mate.
- Doble pared aislante: aísla el hielo de la temperatura ambiente y lo mantiene sólido durante más tiempo. Evita la condensación exterior.
- Incluye tapa 100% de bambú natural y pinza para el hielo de acero inoxidable 18/10.
- Ideal para cubitos de hielo o hielo picado.
- Fácil de transportar: práctica y cómoda asa de acero inoxidable.

- Corps fabriqué en acier inoxydable de la plus grande qualité. Finition mate.
- Double paroi isolante : isole la glace de la température ambiante et la maintient solide plus longtemps. Évite la condensation extérieure.
- Inclut un couvercle 100% en bambou naturel et une pince à glaçons en acier inoxydable 18/10.
- Idéal pour les glaçons ou la glace pilée.
- Facile à transporter : poignée pratique en acier inoxydable.

- Made of top quality stainless steel. Matte finish.
- Double wall insulation: insulates the ice from the room temperature and keeps it solid for longer.
- Prevents external condensation.
- Includes 100% natural bamboo lid and 18/10stainless steel ice tongs.
- Ideal for ice cubes or crushed ice.
- Easy to carry: practical and comfortable stainless steel handle.



Cubitera NORDIC

Seau à glace · Sektkühler
Ice bucket · Porta-cubos gelo

	Ref	€	Ø (cm)	h (cm)	L	U.Venta
	65514	32,00	14	14,5	1,30	1



Cubitera CLEAR

Seau à glace · Sektkühler
Ice bucket · Porta-cubos gelo

Ref	€	Ø (cm)	h (cm)	L	U.Venta
62363	25,80	20	21	3,00	1



Librador

Pelle à farine · Mehlshaufel
Ice shovel · Corredor

Ref	€	ml	L (cm)	A (cm)	U.Venta
67012	17,40	60	19,0	5,0	6
67013	20,30	110	21,5	6,0	6
67014	23,90	200	24,0	7,0	6
67016	26,60	260	25,5	8,5	1
67017	29,50	360	29,0	10,0	6
67018	31,80	470	31,0	11,0	6
67019	39,60	640	35,0	12,5	6
67020	47,40	860	38,0	14,0	6



Pinza de hielo

Pince à glace · Eiszange
Ice tong · Pinça de gelo

	Ref	€	L (cm)	U.Venta
A	62306	4,60	18,5	12
B	62337	9,90	20,0	12



Cargas para botellas sifón CO2

Cartuches CO2 pour siphon · CO2 -Kapsen für Siphon
CO2 soda charges · Botijas de sifão CO2

	Ref	€	Botellas	g	U.Venta
	68602	8,00	10	8	1



Picadora de hielo manual

Broyeur à glace manuel · Manuel Eis-Crusher
Manual ice crusher · Picadora de gelo manual

Ref	€	cm	h (cm)	U.Venta
60327	49,30	16x23	12	1



Librador

Pelle à farine · Mehlshaufel
Ice shovel · Corredor

	Ref	€	ml	Mango (cm)	U.Venta
A	67021	5,70	170	12	1
B	67022	11,60	900	12	1
C	67023	15,90	1800	14	1



Carga de CO2 para botellas de sifón. Una carga de aprox. 8 gr = 1Lt de soda. Un solo uso. Se suministra en caja de 10 unidades. Loading CO2 in bottles with siphons. An (approximately) 8g load is sufficient for 1 l of soda. Single use. Supplied in 10-unit boxes

Botella sifón CO2

Bouteille siphon · Soda-Siphon
Soda maker bottle · Garrafa armadilha

	Ref	€	Ø (cm)	L	U.Venta
	68601	54,90	10x39	1,00	1

Inox
18/10



4
Botellas
Bottles

Dosificador licor DUAL

Mesure à cocktail · Cocktailmass
Jigger · Dosificador licor

Ref	€	h (cm)	cl	U.Venta
A 62329	21,80	9,7	2-2,5 / 4-5	1
B 62330	20,10	9,7	2 / 4	1

A
B



PP
Polipropileno

Maza negra mojito

Pilon noir mojito · Mojitosößel
Black mace mojito · Maço preto mojito

Ref	€	L (cm)	U.Venta
62278	11,20	18	1
62279	12,70	26	1



Colador gusanillo

Passoire à cocktail · Cocktailsieb
Cocktail strainer · Coador batidos

Ref	€	U.Venta
62326	23,60	1

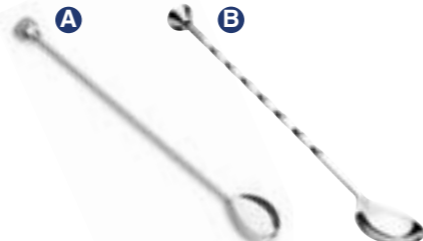

A
B

Cucharilla cocktail

Cuillère cocktail · Barlöffel
Cocktail spoon · Colher cocktail

Ref	€	L (cm)	U.Venta
A 62302	4,70	27	6
B 62352	8,10	28	6

A
B

Aleación
de zinc

Zinc alloy

PARED Abrebotellas

ES

- Fabricado con aleación de zinc.
- Robusto y resistente.
- Fácil de montar, se fija en la pared con los tornillos incluidos.
- Fácil apertura con una sola mano.

FR

- Fabriqué avec un alliage de zinc.
- Robuste et résistant.
- Facile à installer, il se fixe au mur avec les vis incluses.
- Décapsulage facile d'une seule main.

EN

- Made with zinc alloy.
- Strong and sturdy.
- Easy to install; attaches to the wall with the included screws.
- Easy to open with just one hand.



Abrebotellas pared

Décapsuleur mural · Wandflaschenöffner
Wall mounted bottle opener · Abridor de garrafas de parede

Ref	€	cm	U.Venta
63052	4,20	6x3x8	1



VINOTECA Colección

Almacena hasta 6 botellas
Stores up to six bottles

BPA free

6
Botellas
Bottles



Botellero

Casier à vin · Weinregal
Vine rack · Cremalheira do vinho

Ref	€	cm	h (cm)	ØVarilla (mm)	U.Venta
61141	36,80	26,6x14	37,5	4	1

180°C



Si
Silicone

Embudo expandible

Entonnoir extensible · Trichter
Foldable funnel · Funil extensível

Ref	€	Ø (cm)	H (cm)	U.Venta
68085	5,90	8	10,5	1

Dispensador de líquidos BAR-BUTLER

Distributeur de boissons alcoolisées · Spirituosenspender
Liquor dispenser · Dispensador de bebidas

Ref	€	L	U.Venta
62341	92,70	4 cl	1

PARED Abrebotellas

ES

- Fabricado con aleación de zinc.
- Robusto y resistente.
- Fácil de montar, se fija en la pared con los tornillos incluidos.
- Fácil apertura con una sola mano.

FR

- Fabriqué avec un alliage de zinc.
- Robuste et résistant.
- Facile à installer, il se fixe au mur avec les vis incluses.
- Décapsulage facile d'une seule main.

EN

- Made with zinc alloy.
- Strong and sturdy.
- Easy to install; attaches to the wall with the included screws.
- Easy to open with just one hand.

Aleación
de zinc

Zinc alloy



Abrebotellas pared

Décapsuleur mural · Wandflaschenöffner
Wall mounted bottle opener · Abridor de garrafas de parede

Ref	€	cm	U.Venta
63052	4,20	6x3x8	1



Inox



Descapsulador ROND

Coupe capsule · Folien cutter
Foil cutter · Descapsulador

Ref	€	Ø (cm)	U.Venta
63137	4,80	6	12

Inox



Anilla antigoteo

Anneau stop gouttes à vin · Weinring Trop-Stop
Wine drip stop ring · Anilha anti-gota

Ref	€	Ø (cm)	U.Venta
63019	3,10	5	12

Si
Silicone



Inox

Boquilla servidora + tapón

Bec verseur + bouchon · Ausgiess-Aufsatz mit Verschluss
Spout for wine + rubber cap · Boquilha de servir + tampão

Ref	€	U.Venta
63022	4,40	12

Diseñado para oxigenar y ralentizar el flujo del vino garantizando un mejor aroma y potenciando los sabores de manera rápida y sencilla
Designed to slow down the flow of wine, guaranteeing a better bouquet and enhancing flavours quickly and easily

Conserva durante más tiempo el frescor y el sabor del champán o cava
Conserve the freshness and flavour of Champagne or Cava for longer

PMMA
plastic

Si
Silicone



Aireador de vino

Aérateur de vin · Weinbelüfter
Wine aerator · Arejador de vinho

Ref	€	U.Venta
63048	2,80	1

Inox

PP
Polipropileno



B Copper

ABS
plastic



Bloqueo rotativo
Rotary lock

Tapón champán

Bouchon de champagne · Sektflaschenverschluss
Campagne cap · Tampão champanhê

Ref	€	Ø (cm)	h (cm)	U.Venta
A 63021	7,10	-	-	1
B 63055	8,00	3,8	3,5	1

A
B

SACACORCHOS

Colección



ES

- Diseño elegante, moderno y ergonómico: ideal para su uso profesional y de hogar.
- Funcionamiento rápido y sencillo tan solo pulsando un botón.
- Facilita la extracción del corcho de cualquier botella de vino en tan solo 6-8 segundos.
- Extrae el corcho suavemente y de forma silenciosa.
- Cabezal de extracción con iluminación led (63056 / 63057).
- Indicador de batería luminoso mediante LED: 4 niveles para indicar el nivel de energía (63056).
- Se carga mediante cable Micro USB.
- Incluye: cable cargador USB y descapsulador.

FR

- Style élégant, moderne et ergonomique : idéal pour une utilisation aussi bien professionnelle que domestique.
- Fonctionnement rapide et simple en appuyant simplement sur un bouton.
- Facilite l'extraction du bouchon en liège de n'importe quelle bouteille de vin en 6-8 secondes seulement.
- Extraie le bouchon en liège lentement et silencieusement.
- Tête d'extraction avec éclairage led (63056 / 63057).
- Indicateur de batterie lumineux via LED : 4 niveaux pour indiquer le niveau de batterie (63056).
- Se charge à l'aide d'un câble Micro USB.
- Inclut : câble chargeur USB et décapsuleur.

EN

- Smart, modern and ergonomic design - ideal for professional and home use.
- Quick and easy push-button operation.
- Removes the cork from any bottle of wine in just 6-8 seconds.
- Removes the cork gently and quietly.
- Extraction head with led lighting (63056 / 63057).
- Battery indicator led: 4 energy level indicators (63056).
- Charging by Micro USB cable.
- Included: USB charger and decapsulator.



Sacacorchos BLACK LUXE

Tire-bouchon · Korkenzieher
Corkscrew · Saca-rolhas

Ref	€	Ø (cm)	h (cm)	U.Venta
63056	38,30	4,8	22	1



Sacacorchos BLACK

Tire-bouchon · Korkenzieher
Corkscrew · Saca-rolhas

Ref	€	Ø (cm)	h (cm)	U.Venta
63057	29,60	5	19	1



Sacacorchos eléctrico AutoPro

Tire bouchon électrique · Korkenzieher, elektrisch
Electric corkscrew · Saca-rolhas Eléctrico

Ref	€	W	cm	U.Venta
63031	40,70	1,2	Ø12x32	1



Sacacorchos eléctrico SMART

Tire bouchon électrique · Korkenzieher, elektrisch
Electric corkscrew · Saca-rolhas Eléctrico

Ref	€	W	cm	U.Venta
63054	43,70	18	Ø5x25	1

Sacacorchos profesional AUTOMATIC

Tire-bouchon professionnel · Profi-Entkorker
Professional corkscrew · Saca-rolhas professional

	Ref	€	U.Venta
A	63010	324,20	1
B	63012	337,40	1

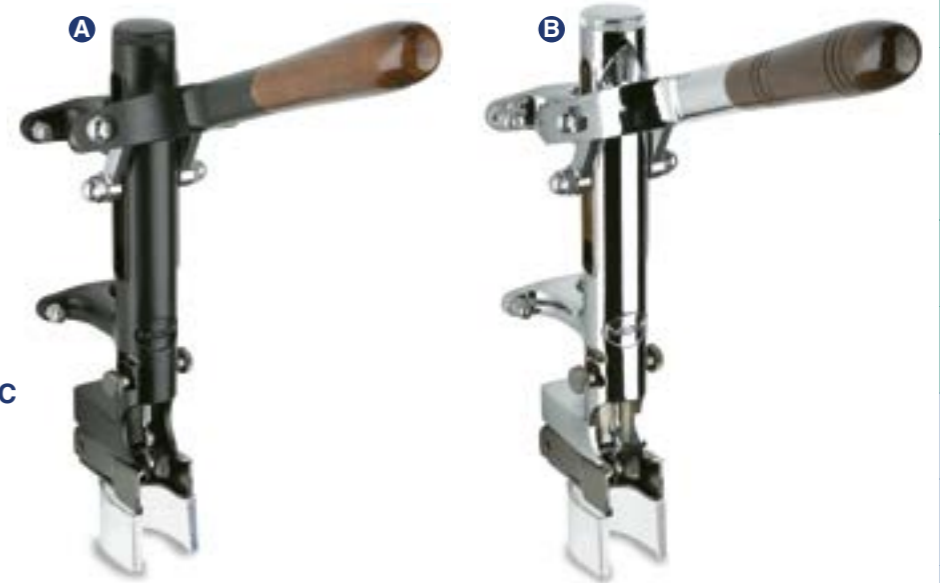

Sacacorchos BLACK

Tire-bouchon · Korkenzieher
Zinc alloy corkscrew · Saca-rolhas

Ref	€	U.Venta
63028	45,90	1

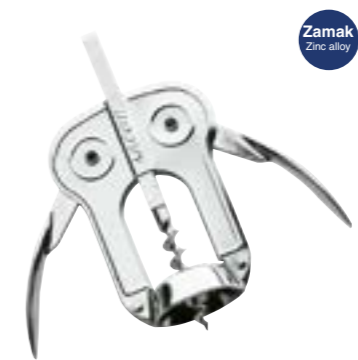

Sacacorchos VIN

Tire-bouchon · Korkenzieher
Zinc alloy corkscrew · Saca-rolhas

Ref	€	U.Venta
63013	17,30	1



Sacacorchos CLASSIC

Tire-bouchon · Korkenzieher
Zinc alloy corkscrew · Saca-rolhas

Ref	€	U.Venta
63047	10,00	1

Multifunción 3 en 1:
sacacorchos + abridor de botellas
+ cuchilla corta cápsulas
Multi-purpose: 3 in 1:
corkscrew + bottle opener+ capsule cutter



Multifunción 3 en 1
Multi-purpose: 3 in 1

Multifunción 3 en 1
Multi-purpose: 3 in 1



Sacacorchos camarero DUO

Tire-bouchon limonadier · Kellnerkorkezieher
Waiter's corkscrew · Saca-rolhas con navalha

Ref	€	U.Venta
63018	5,30	6



Sacacorchos camarero LUXE

Tire-bouchon limonadier · Kellnerkorkezieher
Waiter's corkscrew · Saca-rolhas con navalha

Ref	€	U.Venta
63044	5,10	1



Sacacorchos camarero MADERA

Tire-bouchon limonadier · Kellnerkorkezieher
Waiter's corkscrew · Saca-rolhas con navalha

Ref	€	U.Venta
63046	7,50	1

BOMBAS DE VACÍO

Colección



Carga Charge
50
Ciclos de vacío Vacuum cycles

Incluye 2 tapones con indicador de fecha
Includes 2 caps with date indicator

Base cargador eléctrico
Charging electric base



Bomba de vacío LUXE

Pompe à vide · Weinpumpe
Vacuum pump · Bomba de vacío

Ref	€	Ø (cm)	h (cm)	U.Venta
63058	40,30	4,5	20	1

- Fabricado en ABS de máxima calidad. Acabado color negro mate.
- Conserva el vino en perfecto estado manteniendo todo su sabor y aroma durante más tiempo.
- Extrae el aire acumulado en el interior de la botella y retrasa el proceso de oxidación.
- Fácil de usar: pulsando un solo botón.
- Ahorra tiempo: cierra la botella con el tapón y presiona el botón para extraer el aire en segundos.
- 100% hermético contra fugas.
- Hasta 60 ciclos de vacío en cada carga.
- Kit completo: incluye 2 tapones con indicador de fecha y cargador eléctrico.

- Fabriquée en ABS de la plus grande qualité et en finition de couleur noire mate.
- Conserve le vin en parfait état en maintenant tout son goût et son arôme plus longtemps.
- Extrait l'air accumulé à l'intérieur de la bouteille et retarde le processus d'oxydation.
- Facile à utiliser : appuyer sur un seul bouton.
- Gain de temps : fermer la bouteille avec le bouchon et appuyer sur le bouton pour extraire l'air en quelques secondes.
- 100% hermétique contre les fuites.
- Jusqu'à 60 cycles de vide à chaque charge.
- Kit complet : inclut 2 bouchons avec indicateur de date et base chargeur électrique.

- Made of high quality ABS plastic in a matte black finish.
- Keeps the wine in perfect condition, retaining all its flavour and aroma for much longer.
- Removes the air trapped inside the bottle and slows down the oxidation process.
- Easy to use: works at the press of a single button.
- Saves time: insert the stopper in the bottle and press the button to remove the air in seconds.
- 100% leak-proof.
- Up to 60 vacuum cycles per charge.
- Complete kit: includes 2 stoppers with date indicator and charging electric base.



Inox



Bomba de vacío KEEP

Pompe à vide · Weinpumpe
Vacuum pump · Bomba de vacío

Ref	€	U.Venta
63051	8,90	1
A R63051A	2,30	1

Bomba de vacío INOX

Pompe à vide · Weinpumpe
Vacuum pump · Bomba de vacío

Ref	€	U.Venta
63033	11,20	1
A R63033	3,10	1

- Conserva el vino en perfecto estado manteniendo todo su sabor y aroma durante más tiempo.
- Extrae el aire acumulado en el interior de la botella y retrasa el proceso de oxidación.
- Cierra la botella con el tapón y bombea de 10 a 20 veces (dependiendo de la cantidad de vino que haya dentro de la botella) para establecer el vacío.
- Incluye bomba de vacío y dos tapones (con indicador de la fecha en la que se ha sellado la botella).

- Conserve le vin en parfait état en maintenant tout son goût et son arôme plus longtemps.
- Extrait l'air accumulé à l'intérieur de la bouteille et retarde le processus d'oxydation.
- Refermez la bouteille avec le bouchon et pompez de 10 à 20 fois (selon la quantité de vin à l'intérieur de la bouteille) pour faire le vide.
- Inclut une pompe à vide et deux bouchons (avec indicateur de la date à laquelle a été scellée la bouteille).

- Stores wine in perfect condition and keeps all the flavour and aroma for more time.
- Extracts air built up inside the bottle and slows down the oxidation process.
- Close the bottle with the stopper and pump 10 to 20 times (depending on the amount of wine inside the bottle) to establish the vacuum.
- Includes vacuum pump and two stoppers (with indicator of the date on which the bottle has been sealed).

BAR

Vitrinas expositoras



ES

- Perfectos para proteger y realizar la exposición de alimentos en mostradores de bares, restaurantes, pastelerías, etc.
- Protección contra posibles contaminaciones de los alimentos.

FR

- Idéal zur Präsentation von Produkten auf den Tresen von Bars, Restaurants, Konditoreien usw.
- Schützt Speisen vor Verunreinigungen.

EN

- Perfects for protecting and highlighting products displayed on counters in bars, restaurants, bakeries, etc.
- Protection against potential food contaminants.

Protección contra posibles contaminaciones
Protection against food contaminants



Tapa Roll-Top (Plegable)
Roll-Top Lid (Folding)



Tapa expositora GN 1/1

Couvercle de présentation GN 1/1 · Rolltop-Haube
GN 1/1 display Case Lid · Expositor com tampa GN 1/1

Ref	€	cm	GN	U.Venta
66907P	36,70	53x32,5	GN 1/1	1

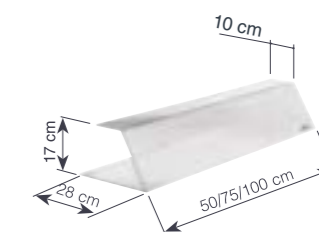

Vitrina expositora bar

Vitrine de présentation pour bar · Tisch-Vitrine Gaststätte
Bar display Case · Vitrina expositora para bar

Ref	€	cm	e (mm)	U.Venta
39450	56,70	50x28x17	5	1
39445	83,80	75x28x17	5	1
39441	118,90	100x28x17	5	1

ES

Un total de 5 modelos de vitrinas neutras, calientes y refrigeradas, diseñadas especialmente para presentar y exponer todo tipo de alimentos, y garantizando siempre la calidad y conservación de estos.

FR

Au total, ce sont 5 modèles de vitrines neutres, chauffantes et réfrigérées, spécialement conçues pour présenter et exposer tout type d'aliments, toujours avec la garantie de leur qualité et leur conservation.

EN

There are 5 models of neutral, warm and refrigerated display cases especially designed to present and display all kinds of food and ensure its quality and conservation at all times.



Parte trasera. Puertas traseras abatibles. Back side. Hinged rear doors

- Vitrina neutra construida íntegramente en cristal y base de acero inoxidable.
- Diseñada para presentar y exponer sobre la barra / mostrador.
- Superficie superior curvada para una visión panorámica.
- Estante intermedio de cristal templado.
- Puerta trasera abatible.
- 4 pies de goma que garantizan máxima estabilidad.

- Vitrine neutre intégralement fabriquée en verre et base en acier inoxydable.
- Conçue pour présenter et exposer sur le plan de travail / comptoir.
- Surface supérieure courbée pour une vision panoramique.
- Étagère intermédiaire en verre trempé.
- Porte arrière rabattable.
- 4 pieds en caoutchouc qui garantissent une qualité maximale.

- Clear countertop display case made entirely of glass, including a stainless steel base.
- Designed for presenting and displaying food on the bar/countertop.
- Full view curved upper surface.
- Middle shelf made of tempered glass.
- Hinged rear door.
- 4 rubber feet for maximum stability.



Vitrina neutra

Vitrine neutre · Einfache vitrine
Clear countertop display case · Vitrina neutra

Ref	€	cm	h (cm)	L	U.Venta
69601	285,30	55,4x37,6	37	45	1

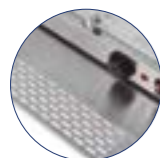

Rejilla extraíble, facilita el flujo del calor. Removable racks for better heat flow



Parte trasera. Puertas traseras abatibles. Back side. Hinged rear doors

- Vitrina térmica fabricada en acero inoxidable y cristal.
- Diseñada para conservar, presentar y exponer sobre la barra / mostrador.
- Puerta trasera abatible.
- Superficie superior inclinada para una visión panorámica.
- Recipiente de agua extraíble que aporta humedad en la cámara.
- Termostato de control de temperatura regulable: 30-90°C.
- Bandeja de rejilla extraíble que facilita el flujo del calor.

- Vitrine thermique fabriquée en acier inoxydable et verre.
- Conçue pour conserver, présenter et exposer sur le plan de travail / comptoir.
- Porte arrière rabattable.
- Surface supérieure inclinée pour une vision panoramique.
- Récipient d'eau extractible qui apporte de l'humidité à la chambre.
- Thermostat de contrôle pour régler la température : 30-90°C.
- Plateau grillagé extractible qui facilite le flux de chaleur.

- Thermal display case made of stainless steel and glass.
- Designed for storing, presenting and displaying food on the bar/countertop.
- Hinged rear door.
- Full view curved upper surface.
- Removable water tray to keep the chamber moist.
- Adjustable temperature control thermostat: 30-90°C.
- Removable racks for better heat flow.



IPX4

Vitrina térmica

Vitrine thermique · Warmhaltevitrine
Thermal display case · Vitrina térmica

Ref	€	W	L	U.Venta
69604	577,00	800	45	1

Ref	Tensión/Voltage	Pot./Power	Capacidad/Capacity	Temp./Temp.	Protec./Protection	Parrilla/Grill	Parrilla/Grill (h)	Dimensiones/Sizes	Peso/Weight
69604	220-240 V; 50 Hz	800	45	30°C - 90°C	IPX4	52,5x28,5 cm	8,5 cm / 10 cm	55,4x37,6x37,6 cm	14,4 Kg

Parte trasera. Puertas traseras correderas. 4 / 6 cubetas gastronorm 1/3 incluidas. Back side. Sliding rear doors. 4/6 Gastronorm 1/3 trays included



IPX4



4 Cubetas Containers



6 Cubetas Containers

Vitrina Térmica

Vitrine thermique · Warmhaltevitrine
Thermal display case · Vitrina térmica

	Ref	€	W	Capacidad	U.Venta
A	69602	636,20	500	4xGN1/3	1
B	69603	731,40	800	6xGN1/3	1

Ref	Tensión/Voltage	Potencia/Power	Capacidad/Capacity	Temperatura/Temp.	Protección/Protection	Dimensiones/Sizes	Peso/Weight
69602	220-240 V; 50Hz	500 W	4 x GN 1/3	30°C - 90°C	IPX4	77,3x42x33,6 cm	16 Kg
69603	220-240 V; 50 Hz	800 W	6 x GN 1/3	30°C - 90°C	IPX4	112,7x42x33,6 cm	22 Kg

Parte trasera. Back side



Vitrina refrigerada

Vitrine réfrigérée · Kühlvitrine
Refrigerated display case · Vitrina refrigerada

Ref	€	W	L	U.Venta
69607	1.084,00	105	40	1

Ref	Tensión/Voltage	Potencia/Power	Capacidad/Capacity	Temperatura/Temp.	Refrigerante/Refr.	Dimensiones/Sizes	Peso/Weight
69607	220-240 V; 50Hz	105 W	40	2°C - 12°C	R600a	68x57,5x33,5 cm	25 Kg

- Vitrina térmica fabricada en acero inoxidable y cristal.
- Diseñada para conservar, presentar y exponer sobre la barra / mostrador.
- Puertas correderas para una accesibilidad total.
- Superficie superior curvada para una visión panorámica.
- 4 / 6 cubetas gastronorm 1/3 incluidas.
- Termostato de control de temperatura regulable: 30 - 90°C.

- Vitrine thermique fabriquée en acier inoxydable et verre.
- Conçue pour conserver, présenter et exposer sur le plan de travail / comptoir.
- Portes coulissantes pour une accessibilité totale.
- Surface supérieure courbée pour une vision panoramique.
- 4 / 6 bacs gastronorm 1/3 inclus.
- Thermostat de contrôle pour régler la température : 30 - 90°C.

- Thermal display case made of stainless steel and glass.
- Designed for storing, presenting and displaying food on the bar/countertop.
- Sliding doors for easy access.
- Full view curved upper surface.
- 4/6 Gastronorm 1/3 trays included.
- Adjustable temperature control thermostat: 30 - 90°C.

69602

Combinaciones posibles. Possible combinations

GN 2/3	GN 2/3
GN 1/3	GN 1/3
GN 1/3	GN 1/3
GN 1/3	GN 1/3

69603

Combinaciones posibles. Possible combinations

GN 2/3	GN 2/3	GN 2/3
GN 1/2	GN 1/2	GN 1/2
GN 1/3	GN 1/3	GN 1/3
GN 1/3	GN 1/3	GN 1/3

- Vitrina refrigerada construida íntegramente en cristal y acero inoxidable.
- Diseñada para conservar, presentar y exponer sobre la barra / mostrador.
- Puertas correderas para una accesibilidad total.
- Superficie superior inclinada para una visión panorámica.
- Sistema de enfriamiento por compresor. Función Defrost.
- Termostato de control de temperatura regulable: 2-12°C.
- Sist. de iluminación LED en la cámara interior y display de control de mandos.

- Vitrine réfrigérée intégralement fabriquée en verre et acier inoxydable.
- Conçue pour conserver, présenter et exposer sur le plan de travail / comptoir.
- Portes coulissantes pour une accessibilité totale.
- Surface supérieure courbée pour une vision panoramique.
- Système de refroidissement par compresseur.
- Thermostat de contrôle pour régler la température : 0-12°C.
- Syst. d'éclairage LED dans la chambre intérieure et écran de contrôle de commandes.

- Refrigerated display case made entirely of glass, including a st. steel base.
- Designed for storing, presenting and displaying food on the bar/countertop.
- Sliding doors for easy access.
- Full view curved upper surface.
- Compressor cooling system. Defrost function.
- Adjustable temperature control thermostat: 2-12°C.
- LED lighting for inner chamber illumination and control display unit.



Control de temperatura regulable
Temperature control thermostat



Tubo desagüe con tapón
Drain tube with cap

Puertas traseras correderas
Sliding rear doors



4
Cubetas
Containers



6
Cubetas
Containers

- Vitrina refrigerada construida íntegramente en cristal y acero inoxidable.
- Diseñada para conservar, presentar y exponer sobre la barra / mostrador.
- Puertas correderas para una accesibilidad total.
- Superficie superior curvada para una visión panorámica.
- Sistema de enfriamiento por compresor.
- 4 / 6 cubetas gastronorm 1/3 incluidas.
- Termostato de control de temperatura regulable: 0-12°C.
- Sistema de iluminación LED en la cámara interior y display de control de mandos.

- Vitrine réfrigérée intégralement fabriquée en verre et acier inoxydable.
- Conçue pour conserver, présenter et exposer sur le plan de travail / comptoir.
- Portes coulissantes pour une accessibilité totale.
- Surface supérieure courbée pour une vision panoramique.
- Système de refroidissement par compresseur.
- 4 / 6 bacs gastronorm 1/3 inclus.
- Thermostat de contrôle pour régler la température : 0-12°C.
- Système d'éclairage LED dans la chambre intérieure et écran de contrôle de commandes.

- Refrigerated display case made entirely of glass, including a stainless steel base.
- Designed for storing, presenting and displaying food on the bar/counter top.
- Sliding doors for easy access.
- Full view curved upper surface.
- Compressor cooling system.
- 4/6 Gastronorm 1/3 trays included.
- Adjustable temperature control thermostat: 0-12°C.
- LED lighting for inner chamber illumination and control display unit.



Vitrina refrigerada

Vitrine réfrigérée · Kühlvitrine
Refrigerated display case · Vitrina refrigerada

Ref	€	W	Capacidad	U.Venta
A 69605	1236,70	160	4xGN1/3	1
B 69606	1371,10	160	6xGN1/3	1

Ref	Tensión/Voltage	Potencia/Power	Capacidad/Capacity	Temperatura/Temp.	Refrigerante/Refrig.	Dimensiones/Sizes	Peso/Weight
69605	220-240 V; 50Hz	160 W	4 x GN 1/3	0°C - 12°C	R600a	112,1x45x33 cm	33 Kg
69606	220-240 V; 50 Hz	160 W	6 x GN 1/3	0°C - 12°C	R600a	148,3x45x33 cm	39 Kg

MENÚ Pizarras



ES

- **Diseño tradicional. Ofrecen un espacio para que los establecimientos de hostelería expongan en sus locales como en la calle sus productos y menús.**
- **Puede ser personalizada tanto con tizas como con rotuladores.**
- **Limpeza muy sencilla, con un simple trapo húmedo.**

FR

- Conception traditionnelle. Offre un espace pour que les établissements d'hôtellerie qui exposent, à l'intérieur ou dans la rue, leurs produits et menus.
- Personnalisable aussi bien avec des craies qu'avec des feutres.
- Nettoyage très facile, avec un simple chiffon humide.

EN

- Traditional design. It offers a space for catering establishments to exhibit their products and menus within their premises as well as out on the street.
- It can be personalized with both chalk and marker pens.
- Very simple cleaning, with just a damp cloth.



Cadena de seguridad que evita su caída
Safety chain to prevent it from falling.

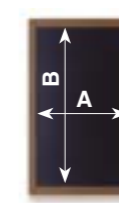

Diseñada para ser colocada en la pared.
Designed to be fixed on the wall.



Pizarra menú

Menu ardoise · Schreiftafel Menu
Menu blackboard · Quadro de menu

Ref	€	cm	AxB (cm)	U.Venta
39166	92,30	55x85	47x67	1
39164	134,00	65x115	55x90	1

Pizarra menú

Menu ardoise · Schreiftafel Menu
Menu blackboard · Quadro de menu

Ref	€	cm	AxB (cm)	U.Venta
A 39162	50,90	50x80	43x73	1
B 39163	55,70	50x80	43x73	1

Madera
Wood



NO incluidos
NOT included

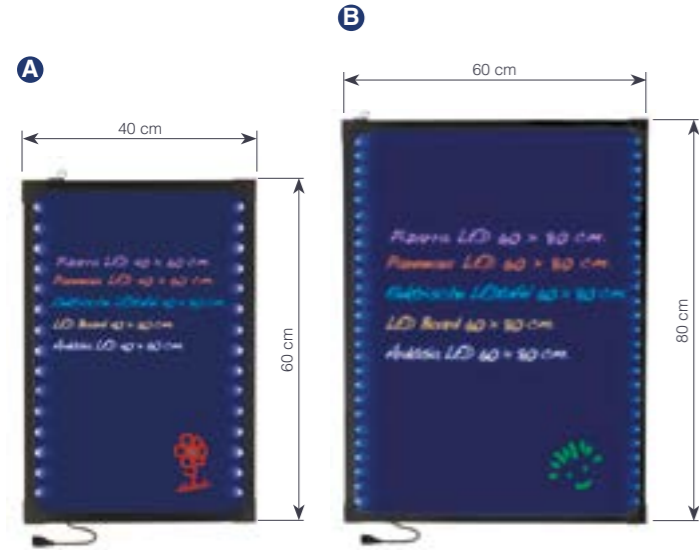

Pizarra eléctrica LED

Tableau lumineux à LED · Elektronische LED Tafel
Electric blackboard LED · Ardósia LED eléctrico

	Ref	€	U.Venta
A	39140	102,70	1
B	39160	141,00	1

Ref	Tensión/Voltage	Potencia/Power	Funcioned/Functions	Dimensiones/Sizes	Peso/Weight
39140	220-240 V; 50/60 Hz	2 W	38	40x60 cm	2,35 Kg
39160	220-240 V; 50/60 Hz	2 W	38	60x80 cm	4,50 Kg



8 colores para usar con la pizarra eléctrica Led
No tóxicos, fácil de limpiar
8 colors to use with the Led electric board
Non toxic, easy to clean

Rotuladores fluorescentes 8 colores

Marqueurs fluorescents 8 couleurs · 8-Farben fluoreszierenden marker
8 Fluorescent markers 8 colors · Maracadores fluirescntes 8 cores

Ref	€	cm	U.Venta
39161	33,20	10	1



- Llamativo sistema de promoción. Gran impacto visual.
- Ideal para cualquier tipo de establecimiento: restaurantes, cafeterías, pubs, tiendas de alimentación, etc.
- Diseñadas para colocarlas tanto vertical como horizontalmente gracias a la cadena suministrada
- Uso similar de las pizarras normales, se escribe sobre la superficie (cristal templado) con rotuladores fluorescentes (Ref.:39161) y se borra con una simple bayeta de fibra.
- Realice el dibujo en la pizarra totalmente desenchufada.

- Système de promotion accrocheur. Grand impact visuel.
- Idéal pour tout type d'établissement : restaurants, cafés, pubs, magasins d'alimentation, etc.
- Conçu pour être placé aussi bien à la verticale qu'à l'horizontale, grâce à la chaîne fournie.
- Semblables à des tableaux normaux, ils permettent d'écrire sur la surface (verre trempé) avec des marqueurs fluorescents (Réf.:39161) et essuyés avec un simple chiffon en fibre.
- Dessinez sur le tableau complètement débranché.

- Eye-catching promotion system. Great visual impact.
- Ideal for any type of establishment: restaurants, cafés, pubs, food shops, etc.
- Designed to be placed both vertically and horizontally, thanks to the the supplied chain
- Similar to normal blackboards, they are used for writing on the surface (tempered glass) with fluorescent markers (Ref.:39161) and wiped off with a simple fibre cloth.
- Draw on the blackboard completely unplugged.

ACRÍLICO · ALUMINIO

Portamenú

ASA AL
Acrylic Aluminium



ES

- Diseño elegante, moderno y fabricado con materiales de máxima calidad.
- Soporte de aluminio.
- 2 o 3 posibilidades de montaje; atril, pared y sobremesa.
- Apto para mostrar menús de tamaño A4 / A3.
- Hoja de información intercambiable de forma fácil, rápida y cómoda.
- Uso en interiores y exteriores.

FR

- Style élégant, moderne et fabriqué avec des matériaux de première qualité.
- Support en aluminium.
- 2 ou 3 possibilités de montage : debout, au mur et sur la table.
- Apte pour afficher des menus de format A4 / A3.
- Changement des documents de façon rapide, facile et pratique.
- Usage à l'intérieur et à l'extérieur.

EN

- An elegant, modern design and manufactured with top quality materials.
- Aluminium stand.
- 2 or 3 mounting possibilities; standing, wall and desktop.
- Suitable for displaying A4 / A3 size menus.
- An easy, quick and convenient exchangeable information sheet.
- Indoor and outdoor use.

ACRÍLICO

3 opciones de montaje · Mounting possibilities



Atril: gracias al soporte de aluminio
Lutrin: grâce au support en aluminium
Lectern: thanks to the aluminum support



Pared: gracias a los accesorios incluidos para anclar en la pared
Mur: grâce aux accessoires inclus à ancrer au mur
Wall: thanks to the included accessories to anchor on the wall



Sobremesa: gracias a los pies de apoyo incluidos
Bureau: grâce aux pieds de support inclus
Table: thanks to the support feet included



Intercambiable de forma fácil, rápida y cómoda
Interchangeable facilement, rapidement et confortablement
An easy, quick and convenient exchangeable

ALUMINIO

2 opciones de montaje · Mounting possibilities



Atril: gracias al soporte de aluminio
Lutrin: grâce au support en aluminium
Lectern: thanks to the aluminum support



Pared: gracias a los accesorios incluidos para anclar en la pared
Mur: grâce aux accessoires inclus à ancrer au mur
Wall: thanks to the included accessories to anchor on the wall



Lámina de polipropileno para evitar el degradado de la hoja de información. Marco de apertura con un solo click
Lame de polypropylène pour empêcher la dégradation dans feuille d'information. Cadre d'ouverture en un clic
Polypropylene sheet to prevent the degradation in information sheet. One-click opening frame



Intercambiable de forma fácil, rápida y cómoda
Interchangeable facilement, rapidement et confortablement
An easy, quick and convenient exchangeable

Portamenú ACRÍLICO

Porte-menu · Menü-Ständer
Menu holder · Porta-menus

Ref	€	cm	U.Venta
A 39403	72,40	50x38 (A3)	1
B 39404	55,70	29x38 (A4)	1

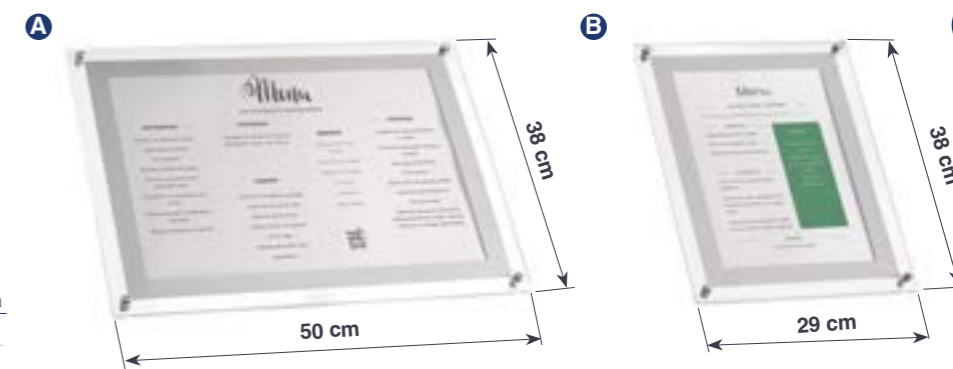

Atril portamenú

Pupitre porte-menu · Menü-Ständer
Menu holder lectern · Atril porta-menus

Ref	€	cm	Tamaño	U.Venta
A 39402	144,90	34x30x1,03 m	-	1
B 39423	217,30	34x30x1,07 m	A3	1
C 39424	200,50	34x30x1,07 m	A4	1



Portamenú ALUMINIO

Porte-menu · Menü-Ständer
Menu holder · Porta-menus

Ref	€	cm	U.Venta
A 39413	39,10	46x34 (A3)	1
B 39414	27,90	25,5x34 (A4)	1

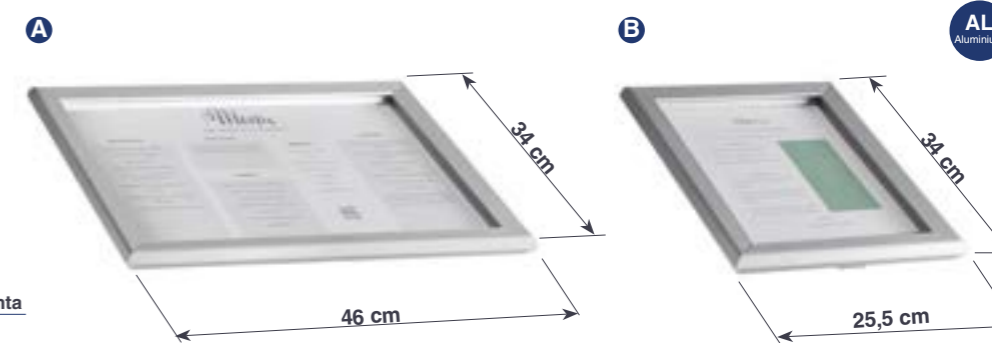

Atril portamenú

Pupitre porte-menu · Menü-Ständer
Menu holder lectern · Atril porta-menus

Ref	€	cm	Tamaño	U.Venta
A 39402	144,90	34x30x1,03 m	-	1
B 39433	183,90	34x30x1,07 m	A3	1
C 39434	172,70	34x30x1,07 m	A4	1



SOBREMESA

Portamenú



ES

- Ideales para resaltar todo tipo de información (menú, especialidades del día, promociones, etc.).
- Desmontables para escribir fácilmente.
- Fácil limpieza.

FR

- Idéales pour faire ressortir tout type d'information (Menu, spécialités du jour, promotions, etc.).
- Démontables pour écrire confortablement.
- Nettoyage facile.

EN

- Perfect for displaying all kinds of information (Fixed price menu, daily specials, promotions, etc.).
- Can be taken apart for easier writing.
- Easy to clean.

Visualización a doble cara
Fijación mediante imán
Base desmontable
Double-sided display
Magnetic fixing
Removable base

Apta para rotuladores fluorescentes
(Ref.: 39161)
Soporte de madera de pino
con acabado caoba
Can be used with fluorescent markers
(Ref.: 39161)
Walnut coloured Pinewood support

Soporte de madera de pino
con acabado caoba
Walnut coloured Pinewood support



Portamenú ACRYLIC
Porte-menu de table · Desktop-Menu
Menu cover · Porta menu de mesa

Ref	€	cm	U.Venta
39405	10,30	11x17	1
39406	11,30	13x19	1
39407	24,40	21x30	1



Portamenú PIZARRA
Porte-menu de table · Desktop-Menu
Menu cover · Porta menu de mesa

Ref	€	cm	U.Venta
39415	15,10	10x15	1
39420	17,90	15x20	1
39430	22,10	20x30	1



Portamenú PINZA
Porte-menu de table · Desktop-Menu
Menu cover · Porta menu de mesa

Ref	€	cm	U.Venta
39410	22,70	18x23	1
A 39411	7,00	-	1

Pinza
Clamp

MESA

Portamenú



Materiales certificados · Matériaux certifiés · Authorised materials

• Similpiel •



Poliuretano de gran calidad con una base de tejido sin tejer suave y ligeramente extensible. Aspecto de piel y tacto único. Gracias al material termovirante, permite conseguir un atractivo efecto de estampado, consiguiendo diferentes colores según la temperatura que se le aplique.

Polyuréthane de grande qualité avec une base de tissu intissé doux et légèrement extensible. Aspect cuir et toucher unique. Grâce au matériau thermo virant, l'on obtient un effet d'imprimé attractif, ainsi que différentes couleurs selon la température qui lui sera appliqué.

High quality polyurethane with a base of soft and slightly extendible unwoven fabric. Leather appearance and unique feel. Thanks to its heat burnishing material an attractive, printed effect is achieved, enabling different colours according to the temperature applied to it.

• Telflex •

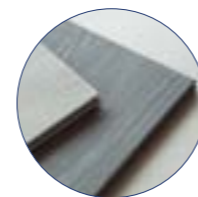

Material compuesto por un soporte celulósico recubierto con una capa vinílica de alta resistencia. Se caracteriza por su gran flexibilidad, durabilidad y resistencia a la abrasión, manchado y rayado. Acabado imitación tela.

Matériau composé d'un support cellulosique recouvert d'une couche vinylique hautement résistante Il se caractérise par sa grande flexibilité, durabilité et résistance à l'abrasion, aux taches et aux rayures. Finition imitation tissu.

A material comprised of a cellulose-based support covered with a high resistance vinyl layer. Characterised by its great flexibility, durability and resistance to abrasion, stains and scratches. Imitation fabric finish.

• Fibra virgen natural •



Fabricadas en fibra virgen natural. Material ecológico y respetuoso con el medio ambiente. Lavables, resistentes y duraderas. Tacto agradable y suave, similar a la piel. Espesor 0,55 mm.

Fabriquées en fibres vierges naturelles. Matériau écologique et respectueux de l'environnement. Lavables, résistantes et durables. Toucher agréable et doux, similaire au cuir. Épaisseur de 0,55 mm.

Made of natural virgin fibre. Ecological material respectful with the environment. Washable, resistant and durable. Nice soft feel, similar to leather. Thickness 0.55 mm.

• PVC •



Fabricados en PVC rígido transparente de alta calidad. Versátiles, económicos, resistentes y ligeros. Hojas transparentes por ambos lados. Ribeteado con cuero cosido en recto. Esquineros metálicos de color negro. Se limpian fácilmente con solución hidroalcohólica sin dañar el producto.

Fabriqués en PVC rigide transparent de grande qualité. Versatiles, économiques, résistants et légers. Feuilles transparentes des deux côtés. Finition avec du cuir cousu sur le recto. Angles métalliques de couleur noire. Nettoyage facile avec du savon, de l'alcool, du gel hydroalcoolique, etc. sans abîmer le produit.

Made of high quality transparent rigid PVC. Versatile, economical, strong and light weight. Transparent sheets on both sides. Edged with straight sewn leather. Black metal corner pieces. Easy to clean with soap, alcohol, hydrogel, etc. without damaging the product.

• Antibacteriano •
Antibacterial

NOTA · NOTE:

La limpieza deberá realizarse con un paño húmedo, pero no saturado de agua. Evite el contacto y la inmersión en agua.

Evite manipularlo con las manos mojadas. NO aptos para el lavavajillas

The cleaning should be done with a damp cloth, but not saturated with water. Avoid contact and immersion in water.

Avoid handling with wet hands. NOT suitable for dishwashers



Lacor pone a disposición del cliente la opción de personalizar cualquiera de las colecciones. La personalización se realiza mediante la técnica de estampado en caliente (termosellado). El logotipo deberá ser enviado vectorizado en formato Adobe Illustrator sino el vectorizado del sello se cobrará 20 €.

Se debe indicar tanto el posicionamiento como el color entre las siguientes opciones:

Lacor propose au client la possibilité de personnaliser n'importe laquelle des collections. La personnalisation est réalisée selon la technique d'estampage à chaud (Thermoscellage). Pour ce faire, le logo devra être envoyé vectorisé en format Adobe Illustrator mais la vectorisation du timbre sera facturée 20 €. Il est nécessaire d'indiquer aussi bien le positionnement que la couleur parmi les options suivantes ::

Lacor offers clients the option of customising any of its collections. Customisation is performed via hot stamping. The logo must be sent in vector format using Adobe Illustrator but the vectorization of the stamp will be charged 20€. Both the position and the colour of the logo must be indicated, choosing from the following options:

Precio · Tarif · Preisliste · Cost · Custo:

España & Portugal: 42€ / Francia: 46€ (a partir de 15 unidades)

Espagne & Portugal: 42€ / France: 46€ (à partir de 15 unités)

Spain & Portugal: 42€ / France: 46€ (minimum 15 units)

*** Nota · Note:**

El plazo de entrega para los portamenús personalizados es de 15 días naturales

The delivery period for the personal portamenús is 15 calendar days



Posicionamiento orientativo

Guidance position

A: Óptico · Optical

B: Centro · Centre

C: Pie centro · Bottom centre

D: Pie drecho · Bottom right

Color

Coleur · Farbe · Colour · Cor

En seco (sin color) · Dry (without colour)

Blanco · White

Negro · Black

Rojo · Red

Oro · Gold

Plata · Silver

Crema · Cream

Marrón · Brown

Azul · Blue

NOTA · NOTE:

NO se recomienda la estampación en seco en las colecciones
Dry printing is NOT recommended in the collections

LISA · VELÁZQUEZ · HELEN · TOMASSO · ANDRÉ · MATISSE · CHARLOTTE · DEGAS · CASSAT · EDGAR · SOPHIE · PAUL
GOYA · MARCEL · ANDY · NATURAL · TEX

· **Made in Spain** ·

Fabricados en España · Fabriqués en Espagne

Spanischer produktion · Fabricados en Espanha



FUNDAS fijas PVC · Protège-feuilles PVC · PVC covers

Fundas fijas de PVC en piel de naranja. Altamente resistentes
Protège-feuilles fixes en PVC en peau d'orange. Hautement résistantes
Highly resistant, fixed frosted PVC covers



SOLAPAS fijas · Rabats fixes · Fixed flaps

Solapas fijas a la cubierta
Rabats fixes sur la couverture
Flaps fixed to the cover

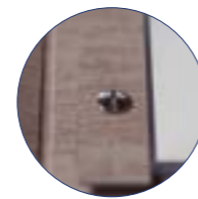

ATORNILLADO interior · Vissage intérieur · Screwed interior

Atornillado interior permite añadir o cambiar hojas o fundas según necesidad del cliente
Vissage intérieur pour intégrer des feuilles ou des protège-feuilles selon les besoins de l'utilisateur
Screwed interior to include pages or covers, according to the user's needs



ATORNILLADO exterior · Vissage extérieur · Screwed exterior

Atornillado exterior permite añadir hojas o fundas según necesidad del cliente
Vissage extérieur pour intégrer des feuilles ou des protège-feuilles selon les besoins de l'utilisateur
Screwed exterior to include pages or covers, according to the user's needs



CORDÓN DE CUERO · Cordon en cuir · Leather cord

Encuadernado con cordón de cuero. Permite añadir hojas o fundas según necesidad del cliente
Relié avec un cordon en cuir. Permet d'ajouter des feuilles ou des pochettes selon les besoins du client
Bound with leather cord. New pages or covers can be added as the customer needs

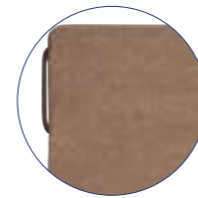

GOMA · Élastique · Elastic band

Encuadernado con goma. Permite añadir hojas o fundas según necesidad del cliente
Relié avec élastique. Permet d'ajouter des feuilles ou des pochettes selon les besoins du client
Bound with elastic band. New pages or covers can be added as the customer needs



PINZA · Pince · Clip

Con pinza metálica de color plata que sujeta la hoja del menú
Doté d'une pince métallique couleur argent qui tient la feuille du menu
With a silver-coloured metal clip that holds the menu in place

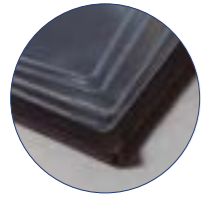

Set 10 fundas interiores PVC piel de naranja

Jeu 10 feuilles intérieures PVC Peau d'orange · 10 Tlg. Innere Blätter, PVC, Orangerhaut
Set 10 interior frosted PVC pages · Set 10 láminas interiores de PVC pele de Laranja

Ref	€	cm	U.Venta	
28191	11,70	21x29,7 (A4)	10	Ref.: 28261, 28500, 28510, 28520, 28530
28192	9,10	14x26	10	Ref.: 28511, 28531, 28521, 28501, 28212, 28262
28190	8,10	16x29,7	10	Ref.: 28342, 28352, 28372
28193	9,20	14,8x21 (A5)	10	Ref.: 28512, 28343, 28532, 28353, 28522, 28373, 28502, 28213, 28263
28194	11,70	21x29,7 (A4)	10	Ref.: 28550, 28540, 28371, 28351
28203	11,70	25x32 (A4)	10	Ref.: 28211, 28231, 28341, 28391
28451	11,90	23x31 (Doble/Double)	10	Ref.: 28411, 28431
28452	10,30	17x32 (Doble/Double)	10	Ref.: 28412, 28432
28453	7,30	16,5x23,5 (Doble/Double)	10	Ref.: 28413, 28423, 28443

Set 12 cantoneras

Jeu 12 coins · 12 Tlg. Kantenschutz
Set 12 angle irons · Set 12 cantoneiras

Ref	€	Color	U.Venta
28195	5,10	Negro · Black	1
28197	5,10	Oro · Gold	1
28198	5,10	Plata · Silver	1

Set 12 tornillos

Jeu 12 vis · 12 Tlg. Schrauben
Set 12 screws · Set 12 parafusos

Ref	€	Color	U.Venta
28196	10,60	Plata · Silver	1
28199	10,90	Negro · Black	1

Set 12 cordones de cuero

Jeu 12 cordons en cuir · 12 Tlg. Lederschnur
Set 12 leather laces · Set 12 cordões de couro

Ref	€	Color	m	U.Venta
28200	1,50	Marrón · Brown	1	12

Set 10 gomas

Jeu 10 élastiques · 10 Tlg. Gummis
Set 10 elastic bands · Set 10 elásticos

Ref	€	Color	U.Venta	
28205	7,20	Negro · Black	1	Ref.: 28411, 28412, 28422, 28432
28206	7,20	Negro · Black	1	Ref.: 28413, 28433



Opción de personalizar
Option of customising

Se recomienda hacerlo en los colores blanco, azul, negro, rojo y marrón
Il est recommandé de le faire dans les couleurs blanc, bleu, noir, rouge et marron
It is recommended to do it in the colors white, blue, black, red and brown

Antibacteriano · Antibacterial

- Ideal para cartas de restaurantes, bares, hoteles, etc.
- Fabricados en PVC rígido transparente de alta calidad.
- Versátiles y económicos. Resistentes y ligeros.
- Hojas transparentes por ambos lados.
- Ribeteado con cuero cosido en recto.
- Esquineros metálicos de color negro.
- Se limpian fácilmente con solución hidroalcohólica sin dañar el producto.

- Idéal pour les cartes des restaurants, bars, hôtels, etc.
- Fabriqués en PVC rigide transparent de grande qualité.
- Versatiles et économiques. Résistants et légers.
- Feuilles transparentes des deux côtés.
- Finition avec du cuir cousu sur le recto.
- Angles métalliques de couleur noire.
- Nettoyage facile avec du savon, de l'alcool, du gel hydroalcoolique, etc. sans abîmer le produit.

- Perfect for restaurant, bar or hotel menus.
- Made of high quality transparent rigid PVC.
- Versatile and economical. Strong and light weight.
- Transparent sheets on both sides.
- Edged with straight sewn leather.
- Black metal corner pieces.
- Easy to clean with soap, alcohol, hydrogel, etc. without damaging the product.



Esquineros metálicos
Metal corners

Portamenú A5

Porte-menu A5 · Speisekartenmappe, A5
A5 menu cover · Porta menu A5

	Ref	€	cm	Fundas	U.Venta
A	28400	8,10	A5	Individual · Individual	1
B	28401	12,40	A5	Doble · Double	1



Esquineros metálicos
Metal corners

Portamenú A4

Porte-menu A4 · Speisekartenmappe, A4
A4 menu cover · Porta menu A4

	Ref	€	cm	Fundas	U.Venta
A	28402	9,90	A4	Individual · Individual	1
B	28403	16,50	A4	Doble · Double	1
C	28404	19,20	A4	Triple · Triplex	1
D	28405	20,80	A4	Cuádruple · Quadruple	1

NATURAL



Blando · Soft

Fabricado en fibra virgen natural
Termosellado en color negro
Sujeción con goma
 Made of natural virgin fibre
 Heat stamping in black
 Closes with elastic band

Portamenú

Porte-menu · Speisekartenmappe
 Menu cover · Porta menu

	Ref	€	cm	Fundas	U.Venta
A	28411	20,80	23x32 (A4)	4	4
B	28412	19,20	17x32	6	4
C	28413	17,00	16,5x23,5 (A5)	6	4



TEX



Blando · Soft

Fabricado en fibra virgen natural
Termosellado en color negro
Sujeción con goma
 Made of natural virgin fibre
 Heat stamping in black
 Closes with elastic band

Portamenú

Porte-menu · Speisekartenmappe
 Menu cover · Porta menu

	Ref	€	cm	Fundas	U.Venta
A	28431	20,80	23x32 (A4)	4	4
B	28432	19,20	17x32	6	4
C	28433	17,00	16,5x23,5 (A5)	6	4



HELEN



Fabricado en simlpiel
Termosellado en color marrón
Encuadernado con cordón de cuero
 Manufactured in imitation leather
 Heat stamping in brown
 Bound with leather cord

Portamenú

Porte-menu · Speisekartenmappe
 Menu cover · Porta menu

	Ref	€	cm	Fundas	U.Venta
A	28341	25,50	25,5x32 (A4)	3	4
B	28342	20,90	19,5 x 32	3	4
C	28343	19,70	19x23,5 (A5)	3	4



VELÁZQUEZ



Fabricado en simlpiel
Termosellado en color marrón
Sujeción fija
 Manufactured in imitation leather
 Heat stamping in brown
 Fixed clamping

Portamenú

Porte-menu · Speisekartenmappe
 Menu cover · Porta menu

	Ref	€	cm	Fundas	U.Venta
A	28331	24,40	23x32 (A4)	4	4
B	28332	19,50	16x28,5	4	4
C	28333	18,60	17x23,5 (A5)	4	4



Portacomandas

Porte-commandes · Halter für Bestellungen
 Order holder · Porta comandas

Ref	€	cm	U.Venta
28175	12,00	11x17,5	4



Portafacturas

Porte-factures · Halter für Rechnungen
 Ticket holder · Porta facturas

Ref	€	cm	U.Venta
28176	19,20	11x18,5	4

LISA



Fabricado en simlpiel
Termosellado en color marrón
Solapas fijas a la cubierta
 Manufactured in imitation leather
 Heat stamping in brown
 Flaps fixed to the cover

Portamenú

Porte-menu · Speisekartenmappe
 Menu cover · Porta menu

Ref	€	cm	U.Venta
28177	22,30	23 x 32 (A4)	4



SANDRO



Fabricado en telflex
Termosellado en color azul
Atornillado exterior permite añadir
hojas o fundas según necesidad del
cliente
Manufactured in telflex
Heat stamping in blue
Screwed exterior to include pages or
covers, according to the user's needs

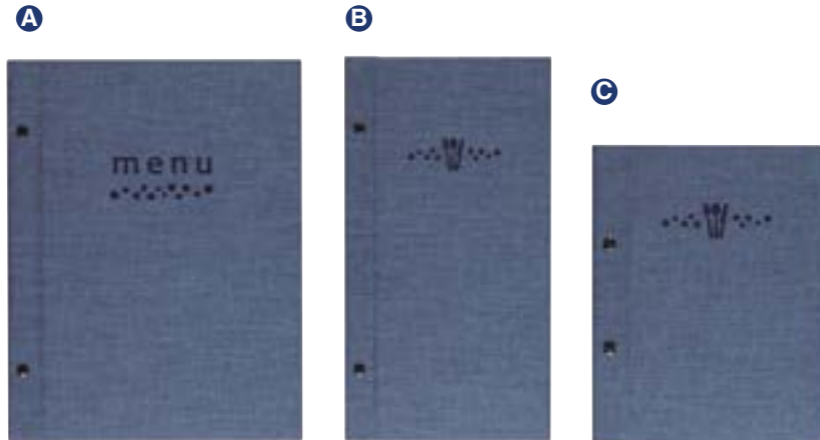

Portamenú

Porte-menu · Speisekartenmappe
Menu cover · Porta menu

Ref	€	cm	Fundas	U.Venta
A 28371	24,70	25,5x32 (A4)	3	4
B 28372	20,30	19,5x32	3	4
C 28373	18,90	19x23,5 (A5)	3	4



Portacomandas

Porte-commandes · Halter für Bestellungen
Order holder · Porta comandas

Ref	€	cm	U.Venta
28375	11,60	11x17,5	4



Porta facturas

Porte-factures · Halter für Rechnungen
Ticket holder · Porta facturas

Ref	€	cm	U.Venta
28376	18,50	11x18,5	4

RENÉ



Fabricado en simlpiel
Termosellado en color crema
Sujeción fija
Manufactured in imitation leather
Heat stamping in cream
Fixed clamping



Portamenú

Porte-menu · Speisekartenmappe
Menu cover · Porta menu

Ref	€	cm	Fundas	U.Venta
A 28021	24,40	23x32 (A4)	4	4
B 28022	18,60	16x28,5	4	4
C 28023	19,50	17x23,5 (A5)	4	4

NICOLÁS



Fabricado en simlpiel
Termosellado en color crema
Atornillado interior permite añadir o
cambiar hojas o fundas según necesi-
dad del cliente
Manufactured in imitation leather
Heat stamping in cream
Screwed interior to include pages or
covers, according to the user's needs

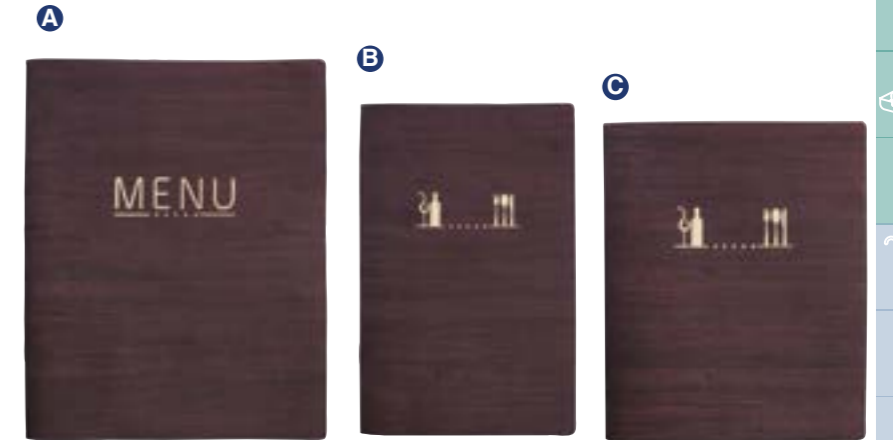

Portamenú

Porte-menu · Speisekartenmappe
Menu cover · Porta menu

Ref	€	cm	Fundas	U.Venta
A 28510	37,70	25,5x32 (A4)	3	4
B 28511	32,10	18x28,5	3	4
C 28512	32,70	19x23,5 (A5)	3	4

ANDRÉ



Fabricado en telflex
Termosellado en color crema
Sujeción fija
Manufactured in telflex
Heat stamping in cream
Fixed clamping

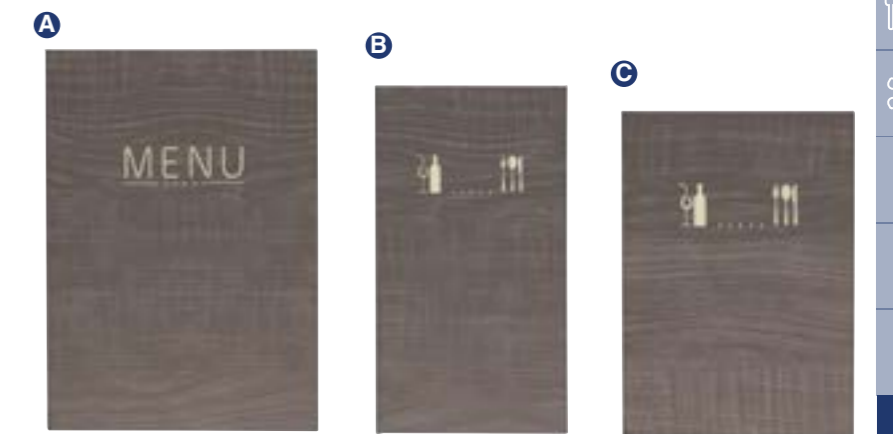

Portamenú

Porte-menu · Speisekartenmappe
Menu cover · Porta menu

Ref	€	cm	Fundas	U.Venta
A 28031	21,20	23x32 (A4)	4	4
B 28032	15,90	16x28,5	4	4
C 28033	16,60	17x23,5 (A5)	4	4

CÉZANE



Fabricado en simlpiel
Termosellado en color crema
Solapas fijas a la cubierta
Manufactured in imitation leather
Heat stamping in cream
Flaps fixed to the cover



Portamenú

Porte-menu · Speisekartenmappe
Menu cover · Porta menu

Ref	€	cm	U.Venta
28041	20,30	23x32 (A4)	4

LEO



Fabricado en simlpiel
Termosellado en color crema
3 solapas transparentes en renoglass 0,40 mm
 Manufactured in imitation leather
 Heat stamping in cream
 3 transparent flaps in renoglass 0,40 mm



Portamenú

Porte-menu · Speisekartenmappe
 Menu cover · Porta menu

Ref	€	cm	Solapas	U.Venta
28151	29,50	23x32 (A4)	3	4

TIZIANO



Fabricado en simlpiel
Termosellado en color crema
3 solapas transparentes en renoglass 0,40 mm
 Manufactured in imitation leather
 Heat stamping in cream
 3 transparent flaps in renoglass 0,40 mm



Portamenú

Porte-menu · Speisekartenmappe
 Menu cover · Porta menu

Ref	€	cm	Solapas	U.Venta
28172	27,00	17x24 (A5)	3	4

CLAUDIO



Fabricado en simlpiel
Con pinza metálica de color plata que sujeta la hoja del menú
 Manufactured in imitation leather
 With a silver-coloured metal clip that holds the menu in place



Portamenú

Porte-menu · Speisekartenmappe
 Menu cover · Porta menu

Ref	€	cm	U.Venta
28321	17,00	23,5x33,5(A4)	4

MATISSE



Fabricado en simlpiel
Termosellado en color negro
Sujeción fija
 Manufactured in imitation leather
 Heat stamping in black
 Fixed clamping

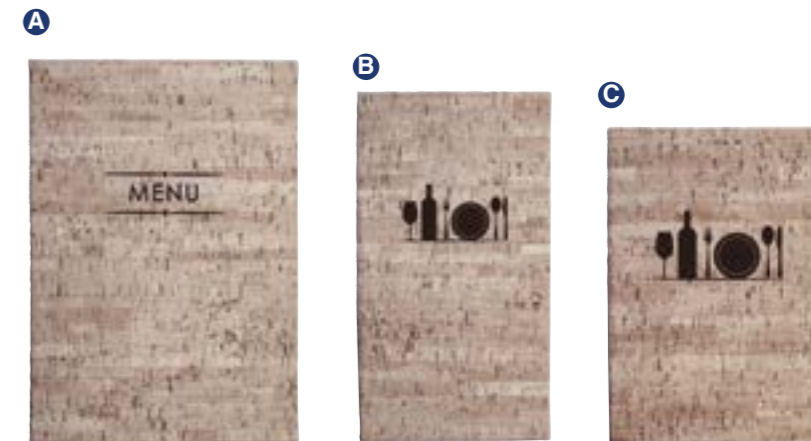

Portamenú

Porte-menu · Speisekartenmappe
 Menu cover · Porta menu

Ref	€	cm	Fundas	U.Venta
A 28051	24,40	23x32 (A4)	4	4
B 28052	18,60	16x28,5	4	4
C 28053	19,50	17x23,5 (A5)	4	4

CHARLOTTE



Fabricado en simlpiel
Termosellado en color negro
Atornillado interior permite añadir o cambiar hojas o fundas según necesidad del cliente
 Manufactured in imitation leather
 Heat stamping in black
 Screwed interior to include pages or covers, according to the user's needs

Blando · Soft

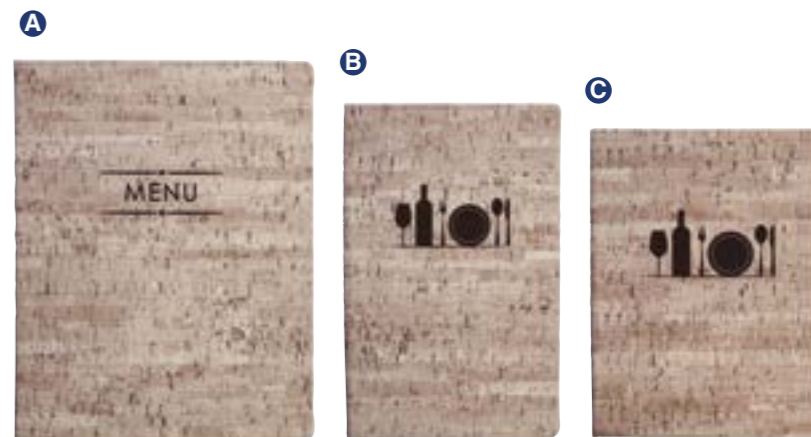

Portamenú

Porte-menu · Speisekartenmappe
 Menu cover · Porta menu

Ref	€	cm	Fundas	U.Venta
A 28530	37,70	25,5x32 (A4)	3	4
B 28531	32,70	18x28,5	3	4
C 28532	32,10	19x23,5 (A5)	3	4

TOMASSO



Fabricado en simlpiel
Termosellado en color negro
Atornillado exterior permite añadir hojas o fundas según necesidad del cliente
 Manufactured in imitation leather
 Heat stamping in black
 Screwed exterior to include pages or covers, according to the user's needs

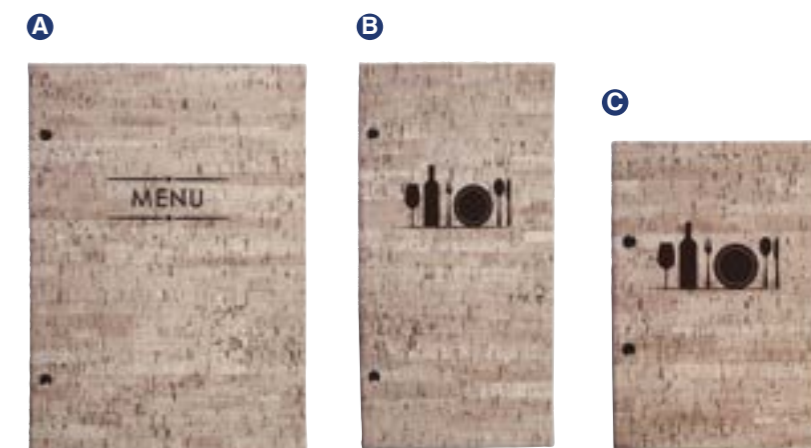

Portamenú

Porte-menu · Speisekartenmappe
 Menu cover · Porta menu

Ref	€	cm	Fundas	U.Venta
A 28351	25,80	25,5x32 (A4)	3	4
B 28352	21,20	19,5x32	3	4
C 28353	20,00	19x23,5 (A5)	3	4

DEGAS



Fabricado en simlpiel
Termosellado en color negro
Solapas fijas a la cubierta
 Manufactured in imitation leather
 Heat stamping in black
 Flaps fixed to the cover



Portamenú

Porte-menu · Speisekartenmappe
 Menu cover · Porta menu

Ref	€	cm	U.Venta
28141	22,30	23x32 (A4)	4

CASSAT



Fabricado en telflex
Termosellado en color negro
Sujeción fija
 Manufactured in telflex
 Heat stamping in black
 Fixed clamping

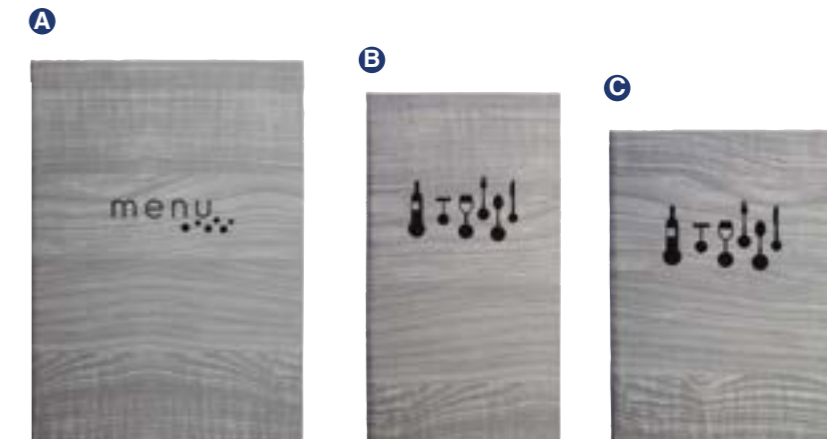

Portamenú

Porte-menu · Speisekartenmappe
 Menu cover · Porta menu

Ref	€	cm	Fundas	U.Venta
A 28061	21,20	23x32 (A4)	4	4
B 28062	15,90	16x28,5	4	4
C 28063	16,60	17x23,5 (A5)	4	4

GOYA



Fabricado en simlpiel
Termosellado en color negro
3 solapas transparentes en renoglass 0,40 mm
 Manufactured in imitation leather
 Heat stamping in black
 3 transparent flaps in renoglass
 0,40 mm



Portamenú

Porte-menu · Speisekartenmappe
 Menu cover · Porta menu

Ref	€	cm	Solapas	U.Venta
28161	29,50	23x32 (A4)	3	4

EDGAR



Fabricado en telflex
Termosellado en color negro
Atornillado exterior permite añadir hojas o fundas según necesidad del cliente
 Manufactured in telflex
 Heat stamping in black
 Screwed exterior to include pages or covers, according to the user's needs



Portamenú

Porte-menu · Speisekartenmappe
 Menu cover · Porta menu

Ref	€	cm	Fundas	U.Venta
28540	22,40	25,5x32 (A4)	3	4

MARCEL



Fabricado en simlpiel
Termosellado en color negro
3 solapas transparentes en renoglass 0,40 mm
 Manufactured in imitation leather
 Heat stamping in black
 3 transparent flaps in renoglass
 0,40 mm



Portamenú

Porte-menu · Speisekartenmappe
 Menu cover · Porta menu

Ref	€	cm	Solapas	U.Venta
28182	27,00	17x24 (A5)	3	4

MAX



Fabricado en telflex
Con pinza metálica de color plata que sujeta la hoja del menú
 Manufactured in telflex
 With a silver-coloured metal clip that holds the menu in place

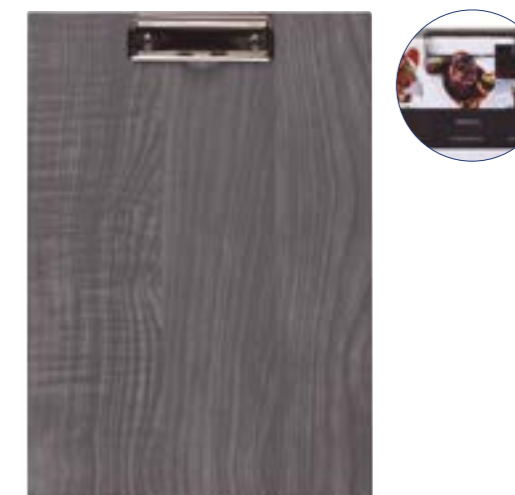

Portamenú

Porte-menu · Speisekartenmappe
 Menu cover · Porta menu

Ref	€	cm	U.Venta
28311	13,70	23,5x33,5(A4)	4

DALÍ



Fabricado en simlpiel
Termosellado en color blanco
Sujeción fija
 Manufactured in imitation leather
 Heat stamping in white
 Fixed clamping

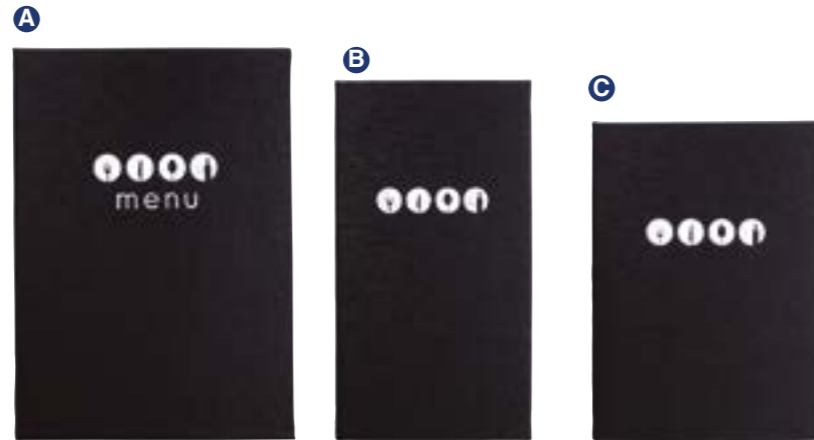

Portamenú

Porte-menu · Speisekartenmappe
 Menu cover · Porta menu

Ref	€	cm	Fundas	U.Venta
A 28101	22,70	23x32 (A4)	4	4
B 28102	17,40	16x28,5	4	4
C 28103	18,30	17x23,5 (A5)	4	4

MARIE



Fabricado en simlpiel
Termosellado en color blanco
Solapas fijas a la cubierta
 Manufactured in imitation leather
 Heat stamping in white
 Flaps fixed to the cover



Portamenú

Porte-menu · Speisekartenmappe
 Menu cover · Porta menu

Ref	€	cm	U.Venta
28560	20,00	23x32 (A4)	4

FRIDA



Fabricado en simlpiel
Termosellado en color negro
Sujeción fija
 Manufactured in imitation leather
 Heat stamping in black
 Fixed clamping

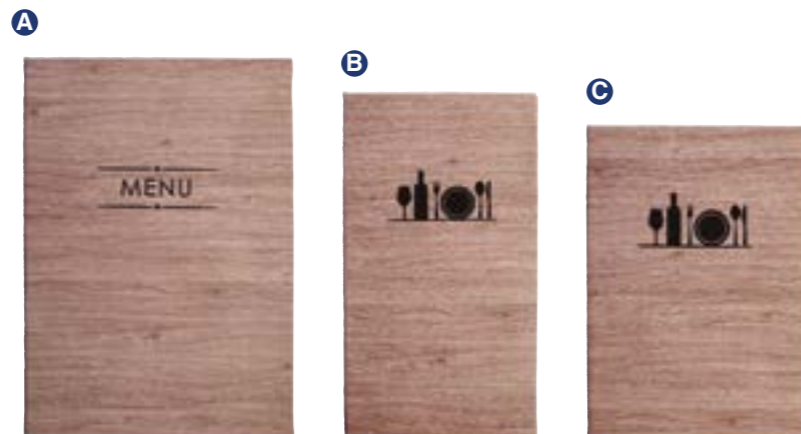

Portamenú

Porte-menu · Speisekartenmappe
 Menu cover · Porta menu

Ref	€	cm	Fundas	U.Venta
A 28011	24,40	23x32 (A4)	4	4
B 28012	18,60	16x28,5	4	4
C 28013	19,50	17x23,5 (A5)	4	4

VERMEER



Blando · Soft

Fabricado en simlpiel
Termosellado en color negro
Atornillado interior permite añadir o
cambiar hojas
o fundas según necesidad del cliente
 Manufactured in imitation leather
 Heat stamping in black
 Screwed interior to include pages or
 covers, according to the user's needs

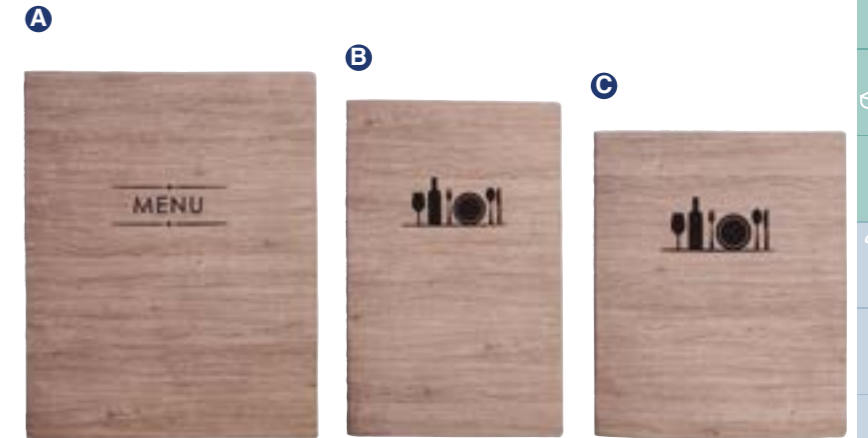

Portamenú

Porte-menu · Speisekartenmappe
 Menu cover · Porta menu

Ref	€	cm	Fundas	U.Venta
A 28500	37,70	25,5x32 (A4)	3	4
B 28501	32,10	18x28,5	3	4
C 28502	32,70	19x23,5 (A5)	3	4

SOPHIE



Fabricado en telflex
Termosellado en color negro
Sujeción fija
 Hergestellt aus telflex
 Heat stamping in black
 Fixed clamping

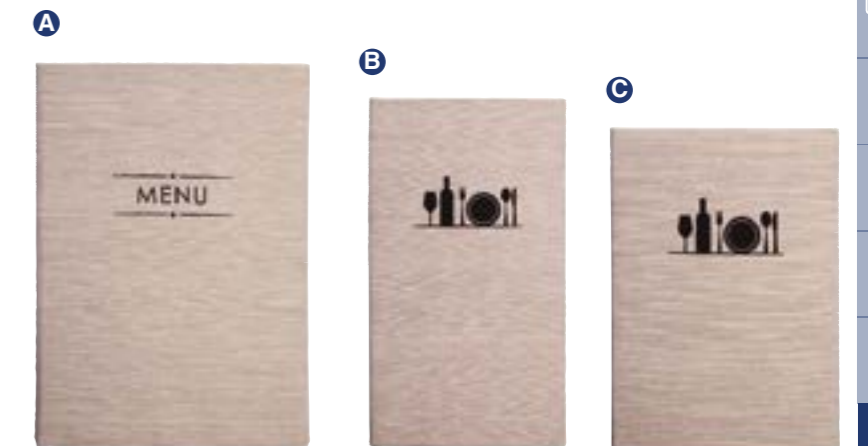

Portamenú

Porte-menu · Speisekartenmappe
 Menu cover · Porta menu

Ref	€	cm	Fundas	U.Venta
A 28081	21,80	23x32 (A4)	4	4
B 28082	16,50	16x28,5	4	4
C 28083	17,00	17x23,5 (A5)	4	4

PAUL



Fabricado en telflex
Termosellado en color negro
Atornillado exterior permite añadir
hojas o fundas según necesidad del
cliente
 Hergestellt aus telflex
 Heat stamping in black
 Screwed exterior to include pages or
 covers, according to the user's needs



Portamenú

Porte-menu · Speisekartenmappe
 Menu cover · Porta menu

Ref	€	cm	Fundas	U.Venta
28550	24,20	25,5x32 (A4)	3	4

PABLO

Fabricado en similpiel
Termosellado en color blanco
Atornillado interior permite añadir o
cambiar hojas o fundas según
necesidad del cliente
 Manufactured in imitation leather
 Heat stamping in white
 Screwed interior to include pages or
 covers, according to the user's needs

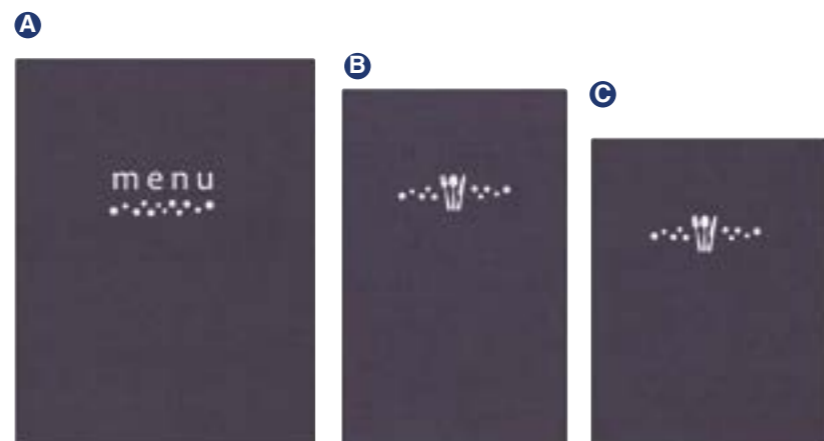

Portamenú

Porte-menu · Speisekartenmappe
 Menu cover · Porta menu

	Ref	€	cm	Fundas	U.Venta
A	28211	30,00	25x32 (A4)	3	4
B	28212	25,10	18x28	3	4
C	28213	24,20	19,5x23,5 (A5)	3	4

ISABELLE

Fabricado en similpiel
Termosellado en color plata
Sujeción fija
 Manufactured in imitation leather
 Heat stamping in silver
 Fixed clamping

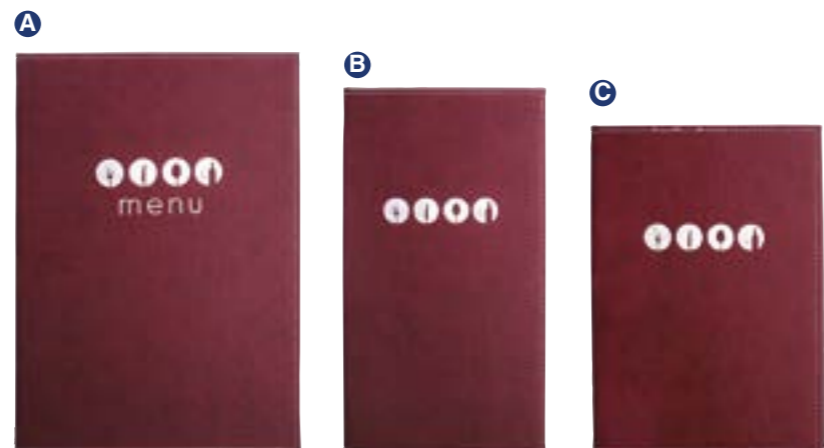

Portamenú

Porte-menu · Speisekartenmappe
 Menu cover · Porta menu

	Ref	€	cm	Fundas	U.Venta
A	28001	26,40	23x32 (A4)	4	4
B	28002	19,70	16x28,5	4	4
C	28003	20,70	17x23,5 (A5)	4	4

MILLET

Fabricado en similpiel
Termosellado en color negro
Sujeción fija
 Manufactured in imitation leather
 Heat stamping in black
 Fixed clamping

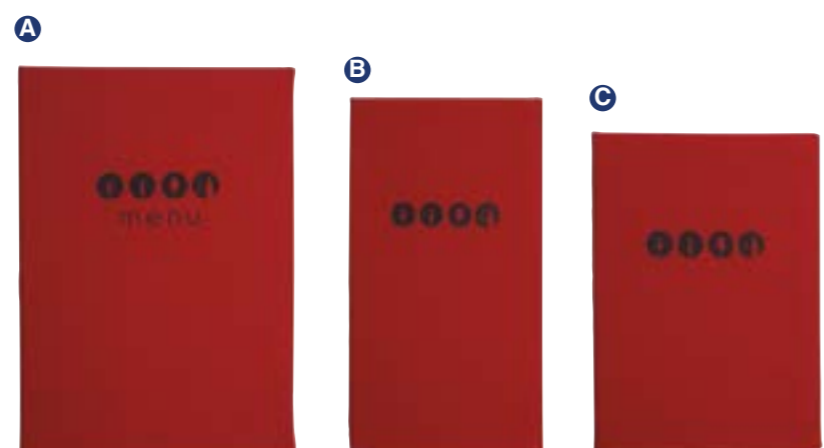

Portamenú

Porte-menu · Speisekartenmappe
 Menu cover · Porta menu

	Ref	€	cm	Fundas	U.Venta
A	28131	22,70	23x32 (A4)	4	4
B	28132	17,40	16x28,5	4	4
C	28133	18,30	17x23,5 (A5)	4	4

GEORGIA



Fabricado en telflex
Con pinza metálica de color plata
que sujeta la hoja del menú
 Manufactured in telflex
 With a silver-coloured metal clip
 that holds the menu in place

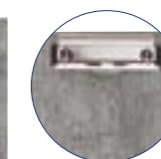

Portamenú

Porte-menu · Speisekartenmappe
 Menu cover · Porta menu

	Ref	€	cm	U.Venta
	28396	14,30	23,5x33,5(A4)	4



04

Corte
Cutting



PROFESIONAL

Colección



Cortador de bolas

Cuillère à pommes · Kugelausstecher
Fruit baller · Cortador bolas

Ref	€	Ø (mm)	U.Venta
60366	7,60	15	1
60367	7,70	20	1
60368	7,70	25	1
60369	7,80	30	1



Cortador de bolas oval rizado

Cuillère à pommes forme oval canelée · Kugelausstecher oval, gerippt
Fruit baller oval fluted · Cortador bolas oval frizado

Ref	€	mm	U.Venta
60372	8,50	20x32,5	1



Cuchillo vaciador

Couteau pour fruits · Frucht messer
Fruit knife · Faca para fruta

Ref	€	mm	U.Venta
60399	6,00	20x105	1



Pelapatatas "Y"

Eplucheur "Y" · "Y" Schäler
"Y" Peeler · Pela-batatas "Y"

Ref	€	mm	U.Venta	
60377	9,50	55x55	1	Liso · Plane
60378	10,10	55x55	1	Dentado · Serrated



Pelapatatas "P"

Eplucheur "P" · "P" Schäler
"P" Peeler · Pela-batatas "P"

Ref	€	mm	U.Venta
60380	6,60	16x55	1



Pelador cuchilla fija

Éplucheur lame fixe · Schäler Messerfix
Fix blade peeler · Pela-batatas lâmina fixa

Ref	€	mm	U.Venta
60398	5,20	15x75	1



LUXE

Colección



Cuchillo para queso

Couteaux à fromage · Käsemesser
Cheese knife kitchen tool · Faca para queijo

Ref	€	cm	L (cm)	U.Venta
62675	11,40	14	28	6



Espátula lisa

Spatule lisse · Backschaufel
Spatula · Espátula

Ref	€	cm	L (cm)	U.Venta
62676	9,70	4,3x11	25	6



Descorazonador

Vide-pommes · Apfelenkerner
Aple corer · Descarçador

Ref	€	cm	L (cm)	U.Venta
62686	9,90	2x2	20	6



Cortador de bolas

Cuillère à pommes · Kugelausstecher
Fruit baller · Cortador de bolas

Ref	€	cm	L (cm)	U.Venta
62683	8,90	3x1	19	6



Pelapatatas "Y"

Eplucheur "Y" · "Y" Schäler
"Y" Peeler · Descascador de batatas "Y"

Ref	€	cm	L (cm)	U.Venta
62687	11,60	5x2	18	6



Pelapatatas "P"

Eplucheur "P" · "P" Schäler
"P" Peeler · Descascador de batatas "P"

Ref	€	cm	L (cm)	U.Venta
62688	10,60	2x1	20	6



Pala pastel serrada

Palette à gâteau dentellé · Kuchenschaufel
Serrated cake shovel · Espátula de bolos c/serrilha

Ref	€	cm	L (cm)	U.Venta
62673	12,60	5,5x13	26	6



Abre ostras LUXE

Couteau à huîtres · Austermesser
Oyster opener · Aberto-ostras

Ref	€	L (cm)	U.Venta
62684	12,60	20	1



Prensa ajos

Presse-pail · Knoblauchpresse
Garlic press · Esmaga-alhos

Ref	€	cm	L (cm)	U.Venta
62685	24,00	3x5	18	6

Abrelatas

Ouvre-boîte · Dosenöffner
Can opener · Abre-latas

Ref	€	cm	L (cm)	U.Venta
62689	26,50	5x4	20	6
63038	22,20	5x4	17	1



PELADORES

Colección



Pelador tomate dentado P

Épluche tomates à dents P · Tomatenschäler, gezackt, P
P Serrated tomato peeler · Pelador tomate dentado P

Ref	€	L (cm)	U.Venta
60351	14,30	19,5	1



Pelador tomate dentado Y

Épluche tomates à dents Y · Tomatenschäler, gezackt, Y
Y Serrated tomato peeler · Pelador tomate dentado Y

Ref	€	L (cm)	U.Venta
60352	14,00	17,5	1



Descorazonador

Vide tomates · Tomatentkerner
Tomato core remover · Descorazador

Ref	€	L (cm)	U.Venta
60353	10,70	16,5	1



Cuchillo dentado

Couteau à dents à tomates · Tomatenmesser, gezahnt
Serrated tomato knife · Faca dentada

Ref	€	L (cm)	U.Venta
60354	10,60	22	1



Pelador liso

Éplucheuse plate · Normalen Schäler
Peeler plain blade · Descascador liso

Ref	€	L (cm)	U.Venta
60547	10,90	12,5	1



Pelador

Éplucheuse · Schäler
Peeler · Descascador

Ref	€	cm	U.Venta
A 60346	11,90	5,5x12	1
B 60347	11,90	5,5x12	1



3 en 1



Pelador "Y" cuchillas giratorias

Éplucheuse "Y" lames tournantes · "Y" Schäler, rotierende Messer
"Y" type peeler rotating blades · Descascador "Y" lâminas giratorias

Ref	€	L (cm)	U.Venta
60389	23,50	20	1



Pelador UNITE

Éplucheuse · Schäler
Peeler · Descascador

Ref	€	L (cm)	U.Venta
A 68197	4,20	14,5	1
B 68198	4,20	14,5	1



Pelador cerámico Y

Éplucheuse en céramique Y · Y Schäler, Keramik
Y ceramic peeler · Descascador cerámico Y

Ref	€	cm	U.Venta
60444	4,00	8,5x16,5	6



Triturador con ranuras

Disposer with rabbet

Cuchara

Spoon

ABS plastic

Funda protectora

Protective

Dientes

Teeth

Cuchillo

Knife

Adaptador extrahuesos

Sextrat bones adapter

Pelador aguacate

Coupe avocat · Schäler avocado
Avocado peeler · Descascador abacate

Ref	€	cm	U.Venta
61355	8,60	28x4	1



Laminador de aguacate

Éplucheuse avocats · Schäler avocados
Avocado slicer · Descascador abacater

Ref	€	cm	L (cm)	U.Venta
61353	11,80	6,2	24	1

Pelador de piña

Set coupe ananas · Ananas-Schäler
Pineapple peeler · Pelador de ananas

Ref	€	Ø (cm)	h (cm)	U.Venta
60392	11,30	10	23	4



New

ABS plastic



Pelador de piña SLIZE

Set coupe ananas · Ananas-Schäler
Pineapple peeler · Pelador de ananas

Ref	€	Ø (cm)	h (cm)	U.Venta
68806	3,80	9	24	1

Funcionamiento práctico, sencillo y eficaz.

Multifuncional: pela, separa el corazón, corta y extrae la piña fresca en cuestión de segundos.

Mango ergonómico para girar sin esfuerzo y empujar el descorazonador a través de la piña.

Desmontable: facilita su limpieza y es apto para el lavavajillas.

Fonctionnement pratique, simple et efficace.

Multifonctions : épluche, sépare le cœur, coupe et extrait l'ananas frais en quelques secondes.

Manche ergonomique pour tourner sans efforts et pousser l'extracteur à travers l'ananas.

Démontable : cela facilite son nettoyage et il est apte pour le lave-vaisselle.

Quick, practical, effective and easy to use.

Multifunctional: peels, cores, slices and extracts fresh pineapple in a matter of seconds.

Ergonomic handle for effortlessly twisting and pushing the corer through the pineapple.

Fully detachable: easy to clean and dishwasher safe.



Juego cortador-pelador piña con base

Jeu couteau et éplucheur ananas · Messer und Schäler set für ananas
Set pineapple cutter-peeler with canister · Jogo cortador e descascador de ananas

Ref	€	Ø (cm)	U.Venta
60393	24,60	9	1



ABS plastic

3 en 1

Click here



PICADORAS

Colección



ES

- Picadora de mecanismo manual que pica todo tipo de alimentos, como verduras, frutas, jengibre, ajo, cebolla, frutos secos y hierbas.
- Cuchilla de acero inoxidable de máxima calidad.
- Recipiente transparente para visualizar el proceso. Libre de BPA.
- Muy fácil y cómodo de usar gracias a su sistema manual PressTurn.
- Tapa de polietileno antideslizante para facilitar la tarea y evitar desplazamientos.
- Fácil de desmontar y limpiar.

FR

- Hachoir à mécanisme manuel qui hache tout type d'aliments, comme les légumes, les fruits, le gingembre, l'ail, l'oignon, les fruits secs et les herbes.
- Lame en acier inoxydable de la plus grande qualité.
- Récipient transparent. Sans BPA.
- Très facile et pratique à utiliser grâce à son système manuel PressTurn.
- Couvercle antidérapant pour faciliter la tâche et éviter les glissements.
- Facile à démonter et à nettoyer.

EN

- Hand-operated food processor for chopping all types of food, such as vegetables, fruit, ginger, garlic, onion, nuts and herbs.
- Top quality stainless steel blade.
- Transparent jar for easy viewing. BPA free.
- Very simple, easy to use manual PressTurn.
- Non-slip lid to simplify the process and avoid slipping.
- Easy to dismantle and clean.



Diseño compacto
Compact design



Picadora manual PRESS

Hachoir manuel · Handschneider
Manual food chopper · Picador manual

Ref	€	Ø (cm)	h (cm)	U.Venta
62819	35,70	9,4	22,7	1



Picadora manual

Hachoir manuel · Handschneider
Manual food chopper · Picador manual

Ref	€	Ø (cm)	h (cm)	U.Venta
62980	31,90	9,5	22	6



Picaperejil

Hachoir à manivelle pour fines herbes · Kräutermühle, fein
St. steel fine herbs mincer · Pica-salsa

Ref	€	cm	U.Venta
60334	22,30	13,5x20x7,5	1

Inox



Picadora de carne manual

Hachoir avec manivelle · Fleischwolf mit handkurbe
Meat mincer · Picadora de carne manual

Ref	€	cm	U.Venta
60329	123,80	17x12x19	1

Multifuncional: pica, bate y centrifuga
Mecanismo de manivela
que requiere muy poca fuerza
Multifunctional: chop, beat and spin
Crank mechanism requiring very little force

Sistema TurnCut
Accionamiento manual de la manivela
100% estable. Sujeción mediante ventosa
TurnCut System
Manual crank operation
100% stable. Suction cup fastening

Inox ABS
plástico



Picadora

Mincer · Fleischwolf
Hachoir · Picadora

Ref	€	cm	U.Venta
60340	34,70	18x22	1

Mini picadora-batidora manual

Mini hachoir-fouet manuel · Minizerhacker-Schneebeesen
Manual mini chooper-whisk · Mini picadora-batedeida manual

Ref	€	Ø (cm)	L	U.Venta
60361	18,10	Ø17x18	1,00	1

OSO

Garras

ES

- Fabricadas en acero inoxidable de máxima calidad.
- Diseñadas para desmenuzar y manipular carnes hechas al horno o barbacoa, como pollo, carne de vacuno, pavo, aves, jamón, etc.
- Puntas afiladas para manipular la carne sin esfuerzo. Forma curvada para un mejor agarre y mayor comodidad.
- Mangos ergonómicos de baquelita resistentes al calor, 100% seguros.
- Multifuncional: desmenuza y traslada la carne, facilita la sujeción para cortes con cuchillo, remueve las ensaladas o pastas, etc.
- Fácil de limpiar. Apta para el lavavajillas.

FR

- Fabriquées en acier inoxydable de la plus grande qualité.
- Conçues pour émincer et manipuler des viandes cuites au four ou au barbecue comme du poulet, du boeuf, de la dinde, de la volaille, du jambon, etc.
- Pointes aiguës pour manipuler la viande sans effort. Forme courbée pour une meilleure prise en main et un plus grand confort.
- Poignées ergonomiques en bakélite résistantes à la chaleur, 100% sûres.
- Multifonctions : émincer et transférer la viande, faciliter la prise en main pour une découpe au couteau, remuer les salades ou les pâtes, etc.
- Facile à nettoyer. Aptes pour le lave-vaisselle.

EN

- Made of top quality stainless steel.
- Designed for shredding and handling baked or barbecued meats, such as chicken, beef, turkey, poultry, ham, etc.
- Sharp tips for easy handling of meats. Curved shape for better grip and comfort.
- Ergonomic heat-resistant Bakelite handles, 100% safe.
- Multifunctional: perfect for shredding, turning and holding meat in place while cutting it with a knife, ideal for mixing salads or pasta, etc.
- Easy to clean. Dishwasher safe.

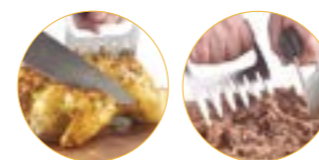

Manipula carnes
Desmenuza carnes
Manipulate meat
Crumble meats

Garras de oso para carne

Griffes à viande · Fleisch Bärenkrallen
Bear claws for meat · Garras de urso para carne

Ref	€	cm	U.Venta
38015	12,70	10,5x12	1

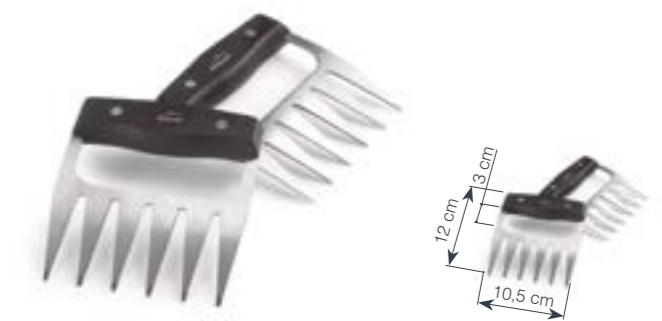

CORTADORES

Colección



ES

- Picadora de mecanismo manual que pica todo tipo de alimentos, como verduras, frutas, frutos secos, dátiles, jengibre, ajo, cebolla, hierbas, etc.
- Incluye tres potentes cuchillas ultrarresistentes fabricadas en acero inoxidable de máxima calidad.
- Práctico y muy fácil de usar: con tal solo tirar del asa las cuchillas se activan.
- Corta con precisión y homogeneamente.
- Asa ergonómica y base antideslizante 100% segura.
- Ocupa poco espacio ya que su asa-tirador se pliega sobre la tapa de la picadora.
- Pequeño, compacto y muy fácil de limpiar.

FR

- Hachoir à mécanisme manuel qui hache tout type d'aliments, comme les légumes, les fruits secs, les dattes, le gingembre, l'ail, les oignons, les herbes, etc.
- Il possède trois puissantes lames ultra-résistantes fabriquées en acier inoxydable de la plus grande qualité.
- Pratique et très facile à utiliser : il suffit de tirer de la poignée pour activer les lames.
- Coupe avec précision et de façon homogène.
- Poignée ergonomique et base antidérapante 100% sûre.
- Prend peu de place car sa poignée se replie sur le couvercle du hachoir.
- Petit, compact et très facile à nettoyer.

EN

- Manual chopper that chops all kinds of food, like vegetables, fruit, nuts, dates, ginger, garlic, onion, herbs, etc.
- It includes three ultra-strong blades made of top quality stainless steel.
- Practical and very easy to use: The blades are activated by simply pulling the handle.
- It cuts precisely and evenly.
- It has an ergonomic handle and a 100% safe non-slip base.
- It doesn't take up much space because the handle-pull folds onto the chopper lid.
- It's small, compact and very easy to clean.

Cuchillas SpinPro ultrarresistentes de acero inoxidable
SpinPro blades ultra-resistant stainless steel



Cortador manual AFFILATO
Coupe manuel · Manuelle Schneider
Manual chopper · Cortador manual

Ref	€	Ø (cm)	h (cm)	L	U.Venta
60599	24,90	13	14	1,2	1

Velocidad I · Speed I
Corta y pica más grueso
Cut and chop more coarsely

Velocidad II · Speed II
Corta y pica más fino
Cut and chop more finely

Corta alimentos duros
It cuts thicker foods

Corta alimentos blandos
It cuts softer foods



Pica y corta alimentos en segundos
It chops and slices foods in seconds



3 cuchillas (6 - 9 - Rodajas 6 mm)
2 empujadores
Peines de limpieza
3 blades (6 - 9 - Slice 6 mm)
2 pushers
Cleaning combs



5 cuchillas ultrarresistentes
5 ultra-strong blades

3 cuchillas ultrarresistentes
3 ultra-strong blades

Cortador manual SHARP
Coupe manuel · Manuelle Schneider
Manual cutter · Cortador manual

	Ref	€	Ø (cm)	h (cm)	L	U.Venta
A	60299	21,10	12	11	0,5	1
B	60499	22,40	13	14	1,0	1

- **2 en 1: cortador de verduras y cortador para preparar patatas Hasselback.**
- **Ideal para cortar en rodajas cualquier tipo de alimento como patata, cebolla, tomate, pepino, zanahoria e incluso carne y pescado.**
- **Mango antideslizante para un agarre firme y pinchos que guían el cuchillo para un corte perfecto y uniforme.**
- **Fácil de limpiar. Apto para el lavavajillas.**

· 2 en 1 coupe-légumes et coupe-pommes de terre pour préparer des pommes de terre Hasselback.

· Idéal pour couper en rondelles tout type d'aliments comme les pommes de terre, les tomates, les concombres, les carottes et même la viande et le poisson.

· Manche antidérapant pour une prise en main ferme et des pointes qui guident le couteau pour une découpe parfaite et uniforme.

· Facile à nettoyer. Convient au lave-vaisselle.

· 2 in 1: vegetable slicer and Hasselback potato slicer.

· Ideal for slicing any type of food such as potatoes, onions, tomatoes, cucumbers, carrots and even meat and fish.

· Non-slip handle for a firm grip and skewers that guide the knife for perfect and even slicing.

· Easy to clean. Suitable for the dishwasher.

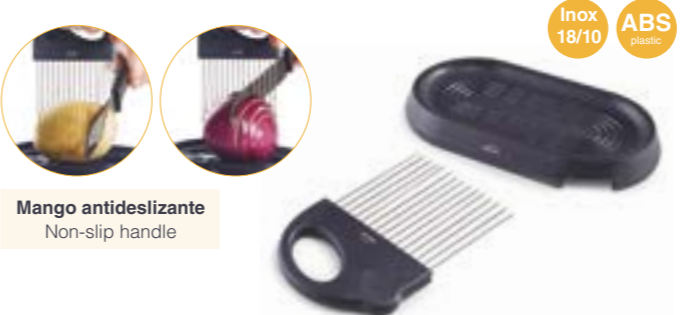

Cortador de patatas HASSELBACK
Coupe-pommes de terre Hasselback · Hasselback-Kartoffelschneider
Hasselback potato slicer · Cortador de batatas Hasselback

Ref	€	cm	h (cm)	U.Venta
68180	9,60	18x10	2,1	1



Cortador de verdura y chips
Coupe de légumes · Gemüseschneidmaschine
Chips and vegetable cutter · Cortador de verdura e chips

Ref	€	cm	h (cm)	U.Venta
60344	45,30	11,5x21,5	11	1

- **Funcionamiento sencillo; insertar el tallo en el agujero que mejor se adapte y deslizar la rama en dirección contraria.**
- **Contiene agujeros de distinto tamaño:**
 - a.- **Los pequeños para deshojar hierbas aromáticas como el romero, orégano, tomillo estragón, etc.**
 - b.- **Los más grandes para separar el tallo más duro que tienen algunas verduras de la hoja como las acelgas, espinacas, col rizada, etc.**
- **Gracias a la parte más aguda, se pueden cortar las hojas con el mismo utensilio.**

· Easy to use. Put the stalk into the hole where it fits best and pull the herb in the opposite direction.

· There are different sized holes:

- a.- The small holes are for stripping leaves from aromatic herbs like rosemary, oregano, thyme, tarragon, etc.
- b.- The bigger holes are for separating harder stalks found in some leafy vegetables like chards, spinach, kale, etc.

· With the sharp end you can use the same utensil to cut leaves.



Deshojador de hierbas aromáticas
Effeuilleuse à herbes aromatiques · Entblätterer für gewürzkräuter
Aromatic herb stripper · Desfolhador de ervas aromáticas

Ref	€	cm	U.Venta
61359	6,50	16,5x7,5x2	1

New

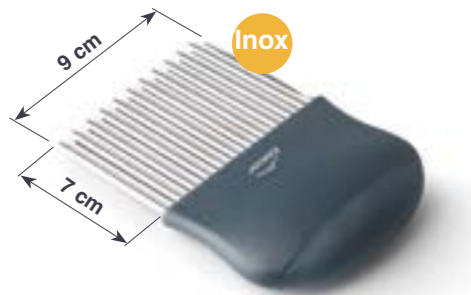

Cortador de patatas ondulado
Coupe-frites ondulé · Kartoffel-Wellenschneider
Crinkle cut potato slicer · Cortador de batatas ondulado

Ref	€	cm	h (cm)	U.Venta
62895	2,90	14x9,5	2	1

Cuchilla ondulada fabricada en acero inoxidable de gran calidad. Cuchilla estable, resistente y afilada para cortar sin esfuerzo. Mango cómodo, robusto y antideslizante. Multiusos; ideal para cortar patatas, zanahorias, calabacines, queso, etc. Fácil de limpiar. Apto para el lavavajillas.

Lame ondulée fabriquée en acier inoxydable de grande qualité. Lame stable, résistante et aiguisée pour couper sans efforts. Manche confortable, robuste et antidérapant. Multi-usages : idéal pour couper des pommes de terre, des carottes, des courgettes, du fromage, etc. Facile à nettoyer. Compatible avec le lave-vaisselle.

Wavy blade made of high quality stainless steel. Stable, strong and sharp blade for effortless slicing. Comfortable, robust and non-slip handle. Multipurpose: perfect for slicing potatoes, carrots, courgette or cheese, etc. Easy to clean. Dishwasher safe.



- Corta frutas y verduras en forma de tallarines.
- Ideal para calabacín, zanahoria, nabo, patata, remolacha etc.
- Alimentación saludable y baja en hidratos de carbono.
- Cuchillas de acero inoxidable. Se utiliza del mismo modo que un sacapuntas.

· Coupe les fruits et les légumes en forme de tagliatelles.
· Idéal pour les courgettes, carottes, navets, pommes de terre, betteraves, etc.
· Alimentation saine et faible en hydrates de carbone.
· Lames en acier inoxydable. S'utilise comme un taille-crayon.

· Slice fruit and vegetables into noodleshapes.
· Ideal for courgettes, carrots, turnips, potatoes, beetroot, etc.
· Healthy and low carbohydrate food.
· Stainless steel blades. Works just like a pencil sharpener.



Cortador de verduras manual DOUBLE

Hachoir de légumes double manuel · Doppelschneidiges Hand Wiegemesser
Vegetables manual double blade chopper · Corta verduras manual duplo lámina

Ref.	€	cm	U.Venta
60365	16,60	17x2	10



Cortahuevos
Coupe-oeuf · Eirschneider
Egg cutter · Corta-ovos

Ref	€	Ø (cm)	U.Venta
A 68305	20,00	7	1
B 68306	18,00	10	12
C 68307	35,50	15x10x3,7	1



Cortador en espiral manual

Coupe en spirale manuelle · Manueller Spiralschneider
Manual spiral cutter · Cortador em espiral manual

Ref	€	Ø (cm)	h (cm)	L	U.Venta
60524	18,60	9	22	0,40	1



Cortador en espiral espagueti

Coupe en spirale · Spiralschneider
Spiral cutter · Cortador em espiral

Ref	€	Ø Int. (cm)	Cuchilla L (cm)	U.Venta
60529	4,00	8	5,5	6



Corta melones-sandias
Trancheur à melons · Wassermelonen-Schneider
Melon cutter-watermelon · Corte os melões-melancia

Ref	€	Ø (cm)	U.Venta
60397	20,10	25,0	1

Guían el cuchillo para un corte perfecto y uniforme
Guide the knife for perfect and even slicing



Peine cortacarne
Peigne pour coupe viande · Fleischzange
Meat tong · Pinça/pente corta-carne

Ref	€	cm	h (cm)	U.Venta
60336	19,70	11x30	6,5	6



Cortabacalao

Couper la morue · Kabeljau-Schneider
Cut cod · Corta-bacalhau

Ref.	€	cm	U.Venta
60000	241,70	11x58,5x8	1



Cortaquesos cuchilla

Coupe-fromage avec lame · Käsemesser, mit Klinge
Cheese cutter with blade · Corta-queijos lâmina

Ref	€	cm	h (cm)	U.Venta
60005	28,80	27,5x21	3	1



Cortador de queso fresco

Fromage coupe fil · Draht-Käseschneider
Cheese wire cutter · Corta-queijos

Ref	€	cm	U.Venta
60004	4,80	17	12
60009	5,30	21	12

Cortapizza
Roulette pizza · Pizzaschneider
Pizza cutter · Corta-Pizza

Ref	€	Ø (cm)	U.Venta
A 60429	5,00	10	12
B 67004	17,50	10	1
C 67028	12,10	10	1
D 67027	5,80	8	6

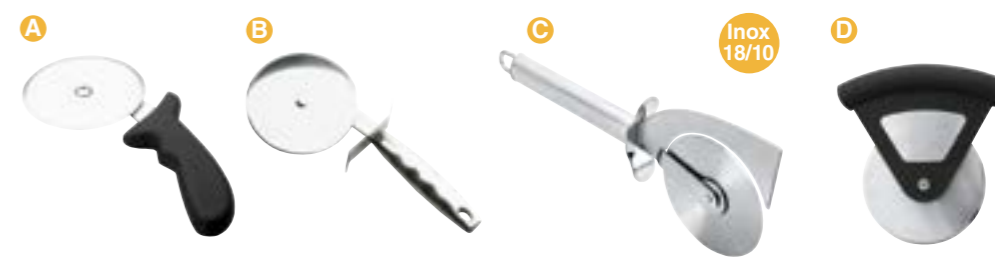

TOMATE

Triturador

Inox ABS SAN LDPE
 Plastic Plastic Container Polyethylene Tapa/Lid BPA free

ES

- Saca el máximo jugo a los alimentos, libre de pieles y semillas.
- Filtro de acero inoxidable de gran calidad y contenedor de polipropileno, libre de BPA.
- Superversátil: prepara salsas de tomate, purés de patata, mermeladas, conservas, etc. con un único aparato.
- Entrada de alimentación de gran capacidad.
- Dispone de un orificio de salida para desechos.
- 100% estable: sistema de sujeción mediante ventosa.
- Incluye empujador para facilitar y agilizar el procesado.
- Totalmente desmontable y fácil de limpiar.



Incluye empujador
 Salida para desechos
Salida de jugo, libre de pieles y semillas
 Includes pusher
 Outlet for waste
 Juice outlet with no peels or seeds

Triturador manual de tomate

Presse-tomates manuel · Handpresse für Tomaten
 manual tomato chopper · Triturador manual de tomate

Ref	€	U.Venta
60394	47,20	1

FR

- Recueillir au maximum le jus des aliments, sans peaux ni pépins.
- Filtre en acier inoxydable de grande qualité et conteneur en polypropylène, sans BPA.
- Très polyvalent: préparer des sauces tomate, des purées, des confitures, des conserves, etc. avec un seul appareil.
- Entrée d'aliments de grande capacité.
- Dispose d'un orifice de sortie pour déchets.
- 100% stable: système de fixation via des ventouses.
- Inclut un poussoir pour faciliter et accélérer le processus.
- Entièrement démontable et facile à nettoyer.

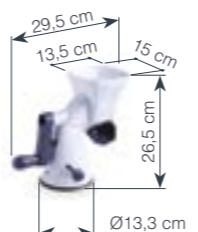

EN

- Designed to get the most juice out of food with no peels or seeds.
- It has a high quality stainless steel filter and a BPA free polypropylene container.
- Extremely Versatile: make tomato sauces, potato purée, marmalade, preserves, etc. with a single appliance.
- High capacity food input
- It has an outlet for waste.
- 100% Stable: it has an attachment system that uses suction cups.
- A pusher is included to make processing food faster and easier.
- It can be completely disassembled and it's very easy to clean.



RALLADORES

Colección

Inox Dishwasher



ES

- Fabricados en acero inoxidable de máxima calidad. Robustos y altamente resistente.
- Disponen de 4/6 caras de distinto corte para obtener el tipo de rallado deseado: fino, medio, grueso y cortes en rodajas.
- Diseñados para rallar y cortar en rodajas todo tipo de alimentos como queso, verduras, nuez moscada, chocolate, etc.
- Asa ergonómica para un mejor agarre y uso.
- Prácticos y muy fáciles para almacenar.

FR

- Fabriquées en acier inoxydable de la plus grande qualité. Robustes et hautement résistante.
- Disposant de 4/6 faces différentes pour obtenir la coupe et le type de grain souhaité: fin, moyen, épais et différentes coupes en rondelles.
- Conçue pour râper tout type d'aliments comme du fromage, des légumes, de la noix de muscade, du chocolat, etc.
- Poignée ergonomique pour une meilleure prise en main et utilisation.
- Pratique et très facile à ranger.

EN

- Made of top quality stainless steel. Robust and highly resistant.
- Features 4/6 different cutting sides to suit all your grating needs: fine, medium, coarse and slices.
- Designed to grate and slice all kinds of food such as cheese, vegetables, nutmeg, chocolate, etc.
- Ergonomic handle for better grip and use.
- Very practical and easy to use.



Contenedor de 250 ml. Marcado en ml y cups
 250 ml container. Marked in ml and cups

Rallador 4 caras KEEP

Râpe 4 faces avec récipient · 4-seitige Reibe m/Behälter
 4-sided grater with container · Ralador 4 lados c/recipiente

Ref	€	cm	h (cm)	U.Venta
61363	6,10	8,9x6,5	20,5	61

Rallador 4 caras WOOD

Râpe 4 faces · 4-seitige Reibe
 4-sided grater · Ralador 4 lados

Ref	€	cm	h (cm)	U.Venta
A 61364	11,00	11x8,5	24,8	1
B 61365	9,10	9x6,5	22,0	1

Rallador MULTI

Râpe · Reibe
 Grater · Ralador

Ref	€	h (cm)	U.Venta
A 60305	7,00	23	6
B 60307	16,10	24	6



Rallador LUXE

Râpe · Reibe
Grater · Ralador

	Ref	€	h (cm)	U.Venta
A	61354	27,80	23,5	1
B	61356	28,00	23,0	1



2 cilindros intercambiables: fino · grueso
2 interchangeable cylinders: fine · coarse

Rallador inox

Hachoir en inox · Käsereibe, Rostfrei
St. steel cheese grater · Ralador inox com manivela

Ref	€	cm	U.Venta
60335	34,40	13,5x20x10	1



Rallador de limón

Râpe muscade · Zitronenreibe
Grater semi-circular · Ralador de limão

Ref	€	cm	U.Venta
67008	6,00	23x6	12



3 en 1

Rallador DUAL

Râpe · Reibe
Grater · Ralador

Ref	€	L (cm)	U.Venta
61360	10,10	31,0	6



4 en 1

Rallador decorador multiusos

Râpe pour décoration multi-usages · Mehrzweckreibe zum Verzieren
Multipurpose zester · Ralador decorador multiusos

Ref	€	L (cm)	U.Venta
63911	11,30	18,0	1

3 en 1



Rallador plano 3 usos

Râpe plat · Reibe 3 Nützlichkeit
Grater 3 uses · Ralador plano 3 usos

Ref	€	cm	U.Venta
60301	7,60	25,5x11	12



Rallador plano paso grueso

Râpe plat · Reibe, grob
Grater big hole · Ralador plano passo grosso

Ref	€	cm	U.Venta
60302	7,60	25,5x11	12



Rallador plano paso fino

Râpe plat · Reibe, fein
Grater small hole · Ralador plano passo fino

Ref	€	cm	U.Venta
60303	7,60	25,5x11	12



Rallador

Râpe · Reibe
Grater · Ralador

	Ref	€	U.Venta	
A	61341	15,60	1	Extra fino · Extra thin
B	61342	15,60	1	Fino · Thin
C	61343	15,60	1	Grueso · Thick
D	61344	15,60	1	Juliana · Julienne



Extremadamente afilado
Extremely sharp



Rallador especias mini

Râpe à épices mini · Mini-Reibe Gewürze
Mini spices grater · Ralador especiarias mini

Ref	€	cm	h (cm)	U.Venta
67032	3,60	11x7	1	6



Rallador nuez moscada

Râpe à muscade · Musket Reibe
Nutmeg grater · Ralador noz-moscada

Ref	€	cm	h (cm)	U.Venta
67031	10,30	4,5x3	15	12



Rallador nuez moscada mini

Râpe à noix de muscade mini · Mini-Musket Reibe
Mini nutmeg grater · Ralador noz-moscada mini

Ref	€	h (cm)	U.Venta
67009	2,10	14	12

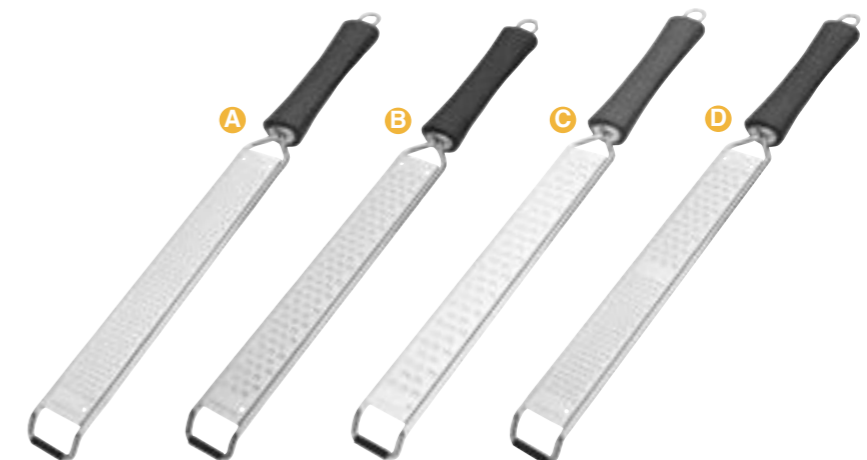

Rallador largo

Râpe longue · Reibe, lang
Lengthways grater · Ralador comprimo

	Ref	€	U.Venta	
A	61346	15,60	1	Fino · Thin
B	61347	15,60	1	Medio · Medium
C	61348	15,60	1	Grueso · Thick
D	61349	15,60	1	Fino+Medio · Thin+Medium

MANDOLINAS

Colección



ES

- Su cuchilla extremadamente afilada proporciona un corte homogéneo y preciso.
- Corte por accionamiento vertical con una palanca de retroceso automático.
- Procesado de alimentos 5 veces más rápido que el trabajo manual.
- Pie plegable y base con 8 ventosas para mejorar la estabilidad en el uso.
- **SEGURO:** protector contra cortes, no hay contacto directo con las manos durante su uso.
- Dispone de un contenedor que recoge los alimentos cortados.
- Palanca con posición de bloqueo de seguridad, muy seguro para su transporte y almacenaje.

FR

- Sa lame extrêmement affilée confère une coupe homogène et précise.
- Coupe par actionnement vertical avec un levier à retour automatique.
- Traitement des aliments 5 fois plus rapide que via le travail manuel.
- Pied pliable et base avec 8 ventouses pour améliorer la stabilité lors de l'utilisation.
- ASSURANCE: Protection anti-coupures. Pas de contact direct avec les mains pendant l'utilisation.
- Dispose d'un conteneur qui recueille les aliments coupés.
- Levier avec position de blocage de sécurité, très sûr pour le transport et le rangement.

EN

- It's extremely sharp blade enables even and precise cutting.
- Vertically operated cutting with an automatic recoil lever.
- Processes food 5 times quicker than manual cutting.
- Foldable legs and base with 8 suckers to improve stability during use.
- SAFE: Anti-cut protector; no direct contact with hands during use.
- Includes a container that collects the chopped food.
- Lever with safety lock position; very safe for transport and storage.

3 tipos de corte · 3 types of cut



Plegable
Bloqueo de seguridad
Fold up
Safety lock position

Mandolina vertical

Mandoline verticale · Mandoline, Vertikale
Vertical mandoline · Mandolina vertical

Ref	€	Corte rodaja	Corte juliana	Corte cubos	U.Venta
60460	40,20	0,5 - 8 mm	4 - 8 mm	8x8 mm ^(max) / 0,5x4 mm ^(min)	1

New



garinox®

Mandolina vertical PRECIS

Mandoline verticale · Mandoline, Vertikale
Vertical mandoline · Mandolina vertical

Ref	€	Rodaja (mm)	Juliana (mm)	U.Venta
60560	25,60	2 - 4	4 - 8	1

Gira la rueda para seleccionar el espesor de corte o el tipo de juliana que deseas obtener
Base antideslizante y protector de dedos que evita el contacto con las cuchillas durante su uso
Turn the wheel to select the thickness of the slice or the type of julienne cut you wish to make
Non-slip base and finger guard to prevent coming in contact with the blades during usage

New design



Mandolina MULTI

Mandoline · Mandoline
Mandoline · Mandolina

Ref	€	cm	U.Venta
60331	30,90	14,5x34,5	1



Mandolina LUXE

Mandoline · Mandoline
Mandoline · Mandolina

Ref	€	cm	U.Venta
60332	117,10	14x42	1



Mandolina V

Mandoline · Mandoline
Mandoline · Mandolina

Ref	€	cm	U.Venta
60356	38,00	13x33,5	1



Cuchillas giratorias
Rotating blades

Mandolina SAFE

Mandoline · Mandoline
Mandoline · Mandolina

Ref	€	cm	U.Venta
60357	126,80	12,5x50	1

EMBUTIDOS

Guillotina



ES

- Diseñada para cortar y rebanar todo tipo de embutidos (Ø 5,5 cm máx.) de forma rápida, segura y sin esfuerzo.
- Cuchilla de acero inoxidable muy afilada de máxima calidad.
- Mango ergonómico que garantiza un agarre fácil y cómodo.
- Máxima seguridad gracias al pasador protector con imán.
- 100% estable. Dispone de 7 almohadillas de goma antideslizantes en la base.
- Apto para el lavavajillas.

FR

- Conçue pour couper et trancher tout type de saucisson, chorizo, rosette... (Ø 5,5 cm max.) de façon rapide, sûre et sans efforts.
- Lame en acier inoxydable très aiguisée de la plus grande qualité.
- Manche ergonomique qui garantit une prise en main facile et pratique.
- Sécurité maximale grâce à l'arceau de protection avec aimant.
- 100% stable. Dispose de 7 patins en caoutchouc antidérapants sur la base.
- Apte pour le lave-vaisselle.

EN

- Designed to cut and slice all types of cold meats (Ø 5.5 cm max.) quickly, safely and effortlessly.
- Extremely sharp top-quality stainless steel blade.
- Ergonomic easy grip comfortable handle.
- Includes safety latch with magnet for maximum safety.
- 100% stable. 7 anti-slip rubber pads on the base.
- Dishwasher safe.

Máxima seguridad: pasador protector con imán
Cuchilla de acero inoxidable muy afilada
Bandeja recoge rebanadas
 Maximum safety: Includes safety latch with magnet
 Extremely sharp top-quality stainless steel blade
 Tray for collecting the cut slices



Guillotina para embutidos

Guillotine à saucisson · Wurtschneider
 Cold meat guillotine · Guillotina para embutidos

Ref	€	cm	h (cm)	U.Venta
60559	21,20	29x19	10,5	1

MÁQUINAS DE CORTE

Colección



ES

- Aumenta la productividad disminuyendo el tiempo de trabajo frente a sistemas convencionales.
- Gama de corte profesional con 4 modelos de corte manual. Con un diseño robusto y ergonómico, gracias a sus cuchillas de acero inoxidable (resistentes a la corrosión), aseguran un corte uniforme y de gran calidad. Ideales para cualquier cocina industrial, su fácil manejo permite obtener un óptimo rendimiento con el mínimo esfuerzo.

FR

- Augmente la productivité et diminue le temps de travail par rapport aux systèmes conventionnels.
- Gamme de coupe professionnelle avec 4 modèles de coupe manuelle. Avec une conception robuste et ergonomique, notamment grâce aux lames en acier inoxydable (résistantes à la corrosion), ils garantissent une coupe uniforme et de grande qualité. Ils s'adaptent parfaitement aux différents types de cuisine industrielle et la facilité de manipulation permet d'obtenir un rendement optimal avec le moindre effort.

EN

- Increases productivity by reducing working time when compared to conventional systems.
- Range of professional cutting Utensils with 4 new manual cutting models. With a robust and ergonomic design, its stainless steel (corrosion resistant) blades ensure a smooth and high quality cut. Ideal for any Industrial kitchen, their ease of use enables optimum performance with minimum effort.



Máquina corta tomates

Machine pour couper tomates · Tomatenschneider
 Tomato cutter machine · Máquina cortador tomate

Ref	€	Espesor (mm) / Nº rodajas	cm	Kg	U.Venta
60510	248,00	5,5 / 9 rodajas	43x20x21	5,20	1

Ventosas de sujeción
 Gripping suckers



Colóquelo donde quiera (mesa-pared-tabla)
4 cuchillas diferentes: 7x7 mm / 10x10 mm / 15x15 mm / 8 gajos
Estructura desmontable y fácil limpieza
 Place it wherever (table-wall-board)
 4 different blades: 7x7 mm / 10x10 mm / 15x15 mm / 8 wedges.
 Collapsible structure and easy cleaning

Máquina corta patatas y gajos

Machine pour chips trancheuse et wedger · Pommes Frites and Wedger-Schneider
 Potato chips slicer and wedger machine · Máquina cortador batatas e gomos

Ref	€	Dados (mm)	Gajos	cm	Kg	U.Venta
60513	223,40	7x7 / 10x10 / 15x15	8	26x26x42	8,0	1

Soporte de sujeción a la superficie de trabajo
 Work surface support bracket

Colóquelo donde quiera (mesa-encimera-tabla)
3 cuchillas diferentes; 6x6 mm / 8x8 mm / 10x10 mm
Estructura desmontable y fácil limpieza
 Place it wherever (table-worktop-board)
 3 different blades: 6x6 mm / 8x8 mm / 10x10 mm
 Collapsible structure and easy cleaning

Corta patatas chip 3 cortadores

Coupe-Frites 3 Lames · Pommes Frites-Schneider, 3 Klängen
 Potato Chips Cutter 3 Blades · Corta-batatas chip 3 cortadores

Ref.	€	Dados (mm)	U.Venta
60343	210,50	6x6 / 8x8 / 10x10	1



Amortiguadores para evitar golpes al cortar los alimentos.
Asa empujador robusta para un mejor manejo.
Patas de goma para una mejor sujeción.
 Shock absorbers to prevent any knocks when cutting food.
 Robust pusher handle for better handling.
 Rubber feet for better grip.

Máquina corta patatas vertical

Machine pour chips trancheuse vertical · Pommes Frites-Schneider vertikal
 Vertical chips slicer machine · Máquina cortador batatas vertical

Ref	€	Dados (mm)	cm	h (cm)	Kg	U.Venta
60511	176,90	10x10	20x20	48	6,0	1

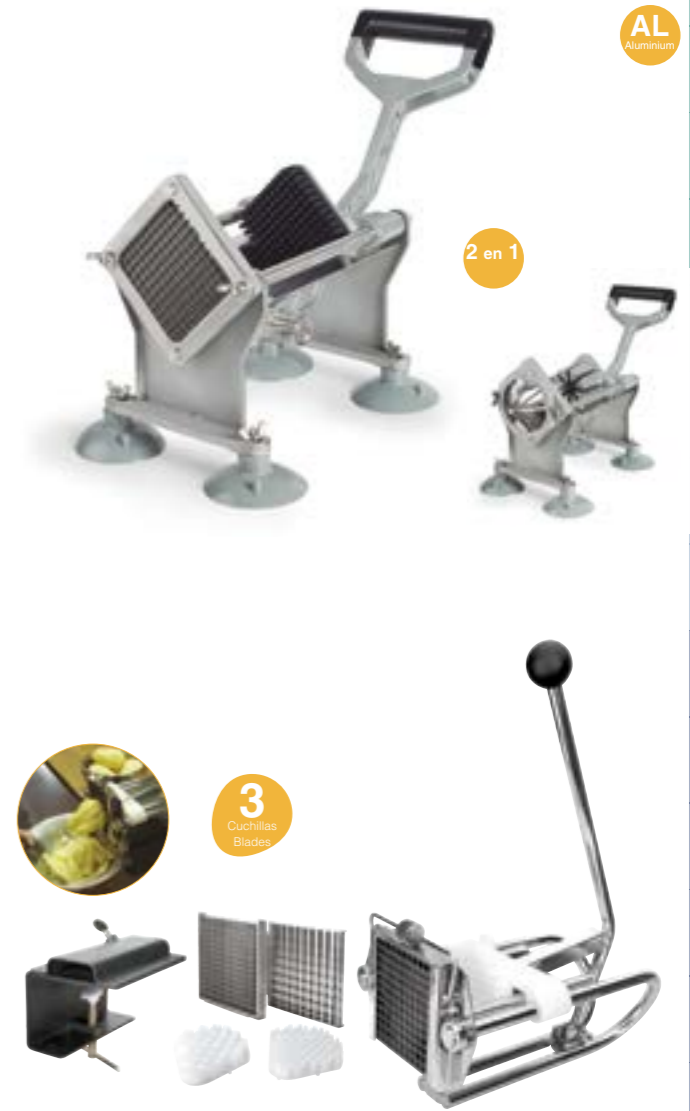

2 en 1

3 Cuchillas Blades

AL Aluminum

CARNICERO

Taco de corte

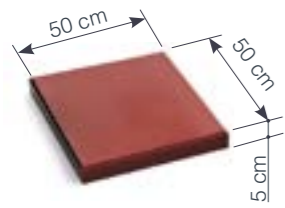

Gran espesor
Great thickness

Tajo de corte carnicero

Planche à découper la viande · Metzger-Schneidblock
Butcher Block · Cepo de corte de carnicero

Ref	€	cm	h (cm)	Kg	U.Venta
60578	174,50	50x50	5,0	12	1

Ideal para cocinas profesionales, carnicerías, pescaderías, etc.

Perfect for professional kitchens, butcher shops or fishmongers, etc.

- Fabricada en polietileno de alta densidad. Espesor de 5 mm.
- Su dureza le confiere una mayor resistencia a la abrasión, durabilidad y una gran absorción de los golpes.
- Material no poroso que facilita su limpieza. No acumula olores ni sabores.
- Apta para lavavajillas.
- Cumple con todas las garantías sanitarias para la manipulación de alimentos exigidas por la unión europea.

- Fabriquée en polyéthylène de haute densité. Épaisseur de 5 mm.
- Sa dureté lui confère une plus grande résistance à l'abrasion, et une durabilité et une absorption des chocs accrues.
- Matériau non poreux qui facilite son nettoyage. Ne garde ni les odeurs ni les goûts.
- Apte pour le lave-vaisselle.
- Répond à toutes les garanties sanitaires pour la manipulation d'aliments exigées par l'Union Européenne.

- Made of high density polyethylene 5 mm Thick
- Its hardness gives it greater resistance to abrasion, more durability and high impact absorption.
- The non-porous material makes it easy to clean. There is no build-up of odours or flavours.
- Dishwasher safe
- Meets all health guarantee for food handling required by the European Union.

JAMONEROS

Colección



Tacos antideslizantes
Non slip plugs

Jamonero

Support pour jambon · Schinkenhalter
Ham-support · Suporte presunto

Ref	€	cm	h (cm)	U.Venta
62344	91,90	50x20,5	35,5	1



Plegable
Folding

Tacos antideslizantes
Non slip plugs

Jamonero abatible

Support pour jambon rabattable · Schinkenhalter, Verstellbar
Folden ham-support · Suporte presunto abatible

Ref	€	cm	h (cm)	U.Venta
62359	90,30	43x19	5	1

PROTECCIÓN

Guantes · Delantal

2
pcs

Composition:
62% PL
24% PET
14% GFRP



Guante protección

Gant de protection · Schutzhandschuh
Protection glove · Luva de protecção

Ref	€	Talla	Medida	Perim. mano	L (cm)	U.Venta
61101	19,50	M	8	182 mm	24	1
61102	19,50	L	9	192 mm	25	1
61103	19,50	XL	10	204 mm	26	1

Guantes certificados según regulación EPI EU 2016/425 módulo B
Gloves certified according to regulation EPI EU 2016/425 module B

Inox



Guante cota

Gant en maille · Netz-Handschuh
Chainman glove · Luva de malha

Ref	€	Talla	Medidas	Perim. mano	Color	U.Venta
39169	139,10	S	7	171 mm	Blanco/White	1
39170	139,10	M	8	182 mm	Rojo/Red	1
39171	139,10	L	9	192 mm	Azul/Blue	1
39172	139,10	XL	10	204 mm	Naranja/Orange	1

Inox



Delantal cota de malla

Tablier en maille · Kettenhemb Schürze
Metal butcher's apron · Avental de malha

Ref	€	cm	Perímetro	U.Venta
39165	322,40	80x55	95-145 cm	1



Resistencia a la abrasión Abrasion resistance	3
Resistencia al corte Blade cut resistance	4
Resistencia al PDM PDM resistance	C
Resistencia al desgarro Tear resistance	4



CE certificate issued by CTC FRANCE

- Ambidiestros, cómodo y ligero.
- **NO emplear con sierras giratorias o dentadas.**

- Ambidextres, pratiques et légers.
- NE PAS utiliser avec des scies giratoires ou dentées.

- Ambidextrous, comfortable and light.
- Do NOT use with rotating or toothed saws.



CE Directive 89/686/EEC and EN 1082-1-1996

- Guante cinco dedos con correa en la muñeca.
- Reversible para mano derecha como izquierda.
- Diseño de correa extraíble y protección completa de mano.
- Fácil lavar y desinfectar.

- Gant cinq doigts avec courroie au poignet.
- Réversible pour main droite et gauche.
- Conception de courroie extractible et protection complète de la main.
- Facile à laver et désinfecter.

- Five-finger glove with strap on the wrist.
- Reversible for both right and left hand.
- Detachable strap and complete hand protection design.
- Easy to wash and disinfect.

Ideal para uso en mandolinas profesionales
Ideal for use in professional mandolins

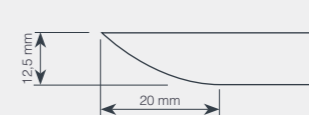

- Ajustable gracias a sus tirantes verticales y horizontales.
- **Conviene asegurarse de que las medidas del cuchillo empleado no sean inferiores a:**

- Ajustable grâce à ses bandes verticales et horizontales.
- Il convient de s'assurer que les dimensions du couteau utilisé ne sont pas inférieures à :

- Adjustable thanks to its vertical and horizontal straps.
- Care must be taken to ensure that the knife used does not measure less than:

ETERN Colección

Inox **PP**
Polypropylene **BPA free**



New

ES

CUCHILLOS

- Fabricados en acero inoxidable de gran calidad.
- Su filo estrecho y delgado permite realizar cortes precisos.
- Mango ergonómico y antideslizante de polipropileno, proporciona un excelente agarre durante el uso.
- Ideal para pelar y cortar cualquier tipo de verduras, frutas, patatas, etc.

PELADORES

- Pelador universal de doble filo oscilante y microdentado de acero inoxidable de gran calidad (39088-39089-39090).
- Pelador fast de doble filo oscilante muy afilado de acero inoxidable de gran calidad (39091-39092-39093).
- Mango ergonómico y antideslizante de polipropileno, proporciona un excelente agarre durante el uso.
- Ideal para pelar todo tipo de verduras y frutas. Ambidiestro gracias a su doble filo.

FR

COUTEAUX

- Fabriquées en acier inoxydable de haute qualité.
- Son tranchant étroit et fin permet de réaliser des coupes précises.
- Le manche ergonomique en polypropylène antidérapant offre une excellente prise en main lors de l'utilisation.
- Idéal pour éplucher et couper tout type de légumes, fruits, pommes de terre, etc.

ÉPLUCHEUR

- Éplucheur universel à double tranchant, oscillant et microdenté, en acier inoxydable de haute qualité (39088-39089-39090).
- Éplucheur à double tranchant oscillant très tranchant en acier inoxydable de haute qualité (39091-39092-39093).
- Le manche ergonomique en polypropylène antidérapant offre une excellente prise en main lors de l'utilisation.
- Idéal pour éplucher toutes sortes de légumes et de fruits. Ambidextre grâce double lame.

EN

KNIFES

- Made of high quality stainless steel.
- Their narrow and thin cutting edge allows for precise cutting.
- Ergonomic, non-slip polypropylene handle for excellent grip during use.
- Ideal for peeling and cutting any kind of vegetables, fruits, potatoes, etc.

PEELER

- Universal peeler with double oscillating, micro-serrated cutting edge of high quality st. steel.
- Ergonomic, non-slip polypropylene handle for excellent grip during use.
- Ideal for peeling all types of vegetables and fruits.
- Ambidextrous design featuring a double-edge cutting blade.

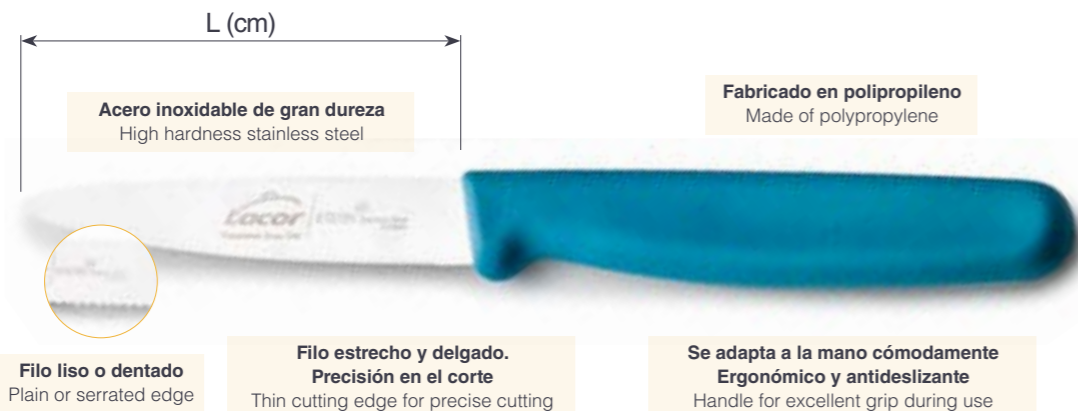

Set de cuchillos puntilla lisos

Set de couteaux d'office lisses · Messer-Set, spit, glattes
Sharp knife set-Plain · Conj. de facas multiusos lisos

Ref	€	L (cm)	U.Venta
39080	6,90	9	1
39083	7,10	10	1

Set de cuchillos puntilla dentados

Set de couteaux d'office dentés · Messer-Set, spit, gezackt
Sharp knife set-Serrated · Conj. de facas multiusos dentado

Ref	€	L (cm)	U.Venta
39081	6,90	9	1
39084	7,10	10	1

Set de cuchillos puntilla mix

Set de couteaux d'office mix · Messer-Set, spit, mix
Sharp knife set-mix · Conj. de facas multiusos mix

Ref	€	L (cm)	U.Venta
39082	6,90	9	1
39085	7,10	10	1



Set de cuchillos mesa

Set de couteaux de table · Tafelmesser-Set
Sharp knife set-table · Conj. de facas de mesa

Ref	€	A (cm)	U.Venta
39086	7,10	10,5	1



Set de cuchillos chuleteros

Set de couteaux à viande · Filetierre-Set
Sharp knife set-choppers · Conj. de facas para carne

Ref	€	A (cm)	U.Venta
39087	7,10	11	1



Pelador Universal

Éplucheur Universel · Universal-Schälmesser
Universal peeler · Descascador Universal

Ref	€	cm	L (cm)	U.Venta
A 39088	5,70	1x5	17	1
B 39089	5,70	1x5	17	1
C 39090	5,70	1x5	17	1

Doble filo oscilante
microdentado
Double oscillating
micro-serrated cutting edge



Pelador Fast

Éplucheur · Schälmesser
Peeler · Descascador

Ref	€	cm	L (cm)	U.Venta
A 39091	5,70	4,5x1	11	1
B 39092	5,70	4,5x1	11	1
C 39093	5,70	4,5x1	11	1

Doble filo oscilante liso
Double oscillating
plain cutting edge

ELITE Colección

ES

- Fabricado en acero inoxidable de alta calidad con una composición de 5Cr15 y una dureza 55±2.
- Hoja muy afilada y resistente al desgaste. Filo acabado en taper grinding.
- Mango ergonómico y antideslizante en ABS con acero inoxidable, proporciona un excelente agarre durante el uso.
- Ideal tanto para uso doméstico como profesional.
- Diseñado para el corte y manipulación de cualquier tipo de carne, pescado, verdura, fruta, patatas, etc.

FR

- Fabriqué en acier inoxydable de grande qualité avec une composition de 5Cr15 et une dureté de 55±2.
- Lame très aiguisée et résistante à l'usure. Fil finition « taper grinding ».
- Manche ergonomique et antidérapant en ABS avec acier inoxydable, qui confère une excellente prise en main pendant l'utilisation.
- Idéal aussi bien pour un usage domestique que professionnel.
- Conçu pour couper et manipuler tout type de viandes, poissons, légumes, fruits, pommes de terre, etc.

EN

- Made of high quality stainless steel with a composition of 5Cr15 and hardness of 55±2.
- Extremely sharp and wear resistant edge Taper ground edge.
- The ABS ergonomic non-slip handle with stainless steel provides an excellent grip during use
- Perfect for home or professional use.
- Designed for cutting and manipulating any kind of meat, fish, vegetables, fruit or potatoes, etc.

New



Cuchillo pelador

Couteau éplucheuse · Schäler Messer
Peeler knife · Faca descascador

Ref	€	cm	U.Venta
38225	9,70	9,0	1



Cuchillo cocina

Couteau de cuisine · Küchenmesser
Kitchen knife · Faca cozinha

Ref	€	cm	U.Venta
38224	9,80	12,5	1



Cuchillo Santoku

Couteau Santoku · Messer Santoku
Santoku knife · Faca Santoku

Ref	€	cm	U.Venta
38223	15,90	18,0	1



Cuchillo fileteador

Couteau filet-de-sole · Filiermesser
Filetting/fish knife · Faca peixe / filetes

Ref	€	cm	U.Venta
38221	14,50	20,0	1



Cuchillo pan

Couteau à pain · Brotmesser
Bread knife · Faca de pão

Ref	€	cm	U.Venta
38222	14,50	20,0	1



Cuchillo Chef

Couteau Chef · Messer Chef
Chef knife · Faca Chef

Ref	€	cm	U.Venta
38220	15,70	20,0	1

MASTER Colección

ES

- Fabricado en acero inoxidable de alta calidad con una composición de 5Cr15 y una dureza 55±2.
- Hoja muy afilada y resistente al desgaste. Filo acabado en taper grinding.
- Mango ergonómico y antideslizante en ABS con acero inoxidable, proporciona un excelente agarre durante el uso.
- Ideal tanto para uso doméstico como profesional.
- Diseñado para el corte y manipulación de cualquier tipo de carne, pescado, verdura, fruta, patatas, etc.

FR

- Fabriqué en acier inoxydable de grande qualité avec une composition de 5Cr15 et une dureté de 55±2.
- Lame très aiguisée et résistante à l'usure. Fil finition « taper grinding ».
- Manche ergonomique et antidérapant en ABS avec acier inoxydable, qui confère une excellente prise en main pendant l'utilisation.
- Idéal aussi bien pour un usage domestique que professionnel.
- Conçu pour couper et manipuler tout type de viandes, poissons, légumes, fruits, pommes de terre, etc.

EN

- Made of high quality stainless steel with a composition of 5Cr15 and hardness of 55±2.
- Extremely sharp and wear resistant edge Taper ground edge.
- The ABS ergonomic non-slip handle with stainless steel provides an excellent grip during use
- Perfect for home or professional use.
- Designed for cutting and manipulating any kind of meat, fish, vegetables, fruit or potatoes, etc.

New



Cuchillo pelador

Couteau éplucheuse · Schäler Messer
Peeler knife · Faca descascador

Ref	€	cm	U.Venta
38235	6,20	9,0	1



Cuchillo cocina

Couteau de cuisine · Küchenmesser
Kitchen knife · Faca cozinha

Ref	€	cm	U.Venta
38234	6,30	12,5	1



Cuchillo Santoku

Couteau Santoku · Messer Santoku
Santoku knife · Faca Santoku

Ref	€	cm	U.Venta
38233	10,60	18,0	1



Cuchillo fileteador

Couteau filet-de-sole · Filiermesser
Filetting/fish knife · Faca peixe / filetes

Ref	€	cm	U.Venta
38231	9,30	20,0	1



Cuchillo pan

Couteau à pain · Brotmesser
Bread knife · Faca de pão

Ref	€	cm	U.Venta
38232	9,30	20,0	1



Cuchillo Chef

Couteau Chef · Messer Chef
Chef knife · Faca Chef

Ref	€	cm	U.Venta
38230	10,50	20,0	1

CLASSIC

Colección

ES

- Cuchillos forjados realizados en una sola pieza.
- Fabricados en acero inoxidable X 45 Cr Mo V 15. Dureza de 54-58 HRC.
- Mango ergonómico.
- Remaches resistentes a la corrosión.
- Cuchillo estable, fuerte y de gran durabilidad.

FR

- Couteaux forgés réalisés en une seule pièce.
- Fabriqués en acier inoxydable X 45 Cr Mo V 15. Dureté 54-58 Hc.
- Manche ergonomique.
- Rivets résistants à la corrosion.
- Couteau stable, solide et d'une grande durabilité.

54-58 MOLYBDÄNSTAHL Cuchillo forjado
 HRC X 45 Cr Mo V 15 Forged knives Dishwasher
 Acero inoxidable al cromo-molibdeno-vanadio
 Chrome-molybdenum-vanadium stainless steel

EN

- One-piece forged knives.
- Made with X 45 Cr Mo V 15 stainless steel. 54-58 Hc hardness.
- Ergonomic handle.
- Corrosion resistant rivets.
- A stable, strong and extremely durable knife



Cuchillo CHEF

Couteau de chef · Messer Chef
 Cook's knife · Faca Chef

Ref	€	cm	U.Venta
39016	20,10	16	1
39021	24,80	21	1
39025	28,20	25	1
39030	36,20	30	1



Cuchillo cocina

Couteau de cuisine · Küchenmesser
 Kitchen knife · Faca cozinha

Ref	€	cm	U.Venta
39110	10,30	10	1
39112	11,70	12	1
39114	13,20	14	1
39116	16,00	16	1
39118	17,90	18	1
39121	18,70	21	1
39125	20,10	25	1



Cuchillo pescado / fileteador

Couteau filet-de-sole · Filiermesser
 Filleting/fish knife · Faca peixe / filetes

Ref	€	cm	U.Venta
39115	13,20	20	1



Cuchillo deshuesador

Couteau à désosser · Ausbeinmesser
 Boning knife · Faca desossador

Ref	€	cm	U.Venta
39014	16,00	14	1



Cuchillo patatero

Couteau office · Gemüsemesser
 Paring knife · Faca batatas

Ref	€	cm	U.Venta
39185	10,90	8,50	1



Cuchillo jamonero

Couteau à jambon · Schinkenmesser
 Ham knife · Faca de presunto

Ref	€	cm	U.Venta
39020	20,80	21	1
39024	23,40	26	1



Cuchillo pan

Couteau à pain · Brotmesser
 Bread knife · Faca de pão

Ref	€	cm	U.Venta
39027	18,80	21	1



Cuchillo congelados

Couteau aliments surgelés · Gefrierwarenmesser
 Frozen food knife · Faca congelados

Ref	€	cm	U.Venta
39028	19,60	21	1



Tenedor de trinchar

Fourchette de chef · Tranchiergabel
 Cook's fork · Garfo de trinchar

Ref	€	cm	U.Venta
39017	16,70	18	1



Machete

Couperet · Hackfleischmesser
 Cleaver · Cutelo

Ref	€	cm	U.Venta
39015	57,40	16	1

Macheta

Couperie · Hackfleischmesser
 Cleaver · Cutelo

Ref	€	cm	U.Venta
39018	21,30	17x8	1

Macheta para pescado

Couperie à poisson · Sehr Scharfes fischmesser
 Fish cleaver · Cutelo para peixe

Ref	€	mm	U.Venta
39029	22,00	290	1



Chaira

Fusil à affûter · Wetzstahl
 Sharpening steel · Fusil

Ref	€	L (cm)	U.Venta
39010	21,00	21	1

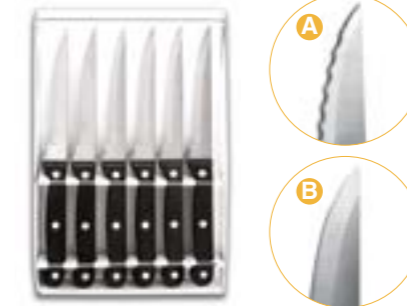

Set 6 cuchillos chuleteros

6 couteau steak · 6 steakmesser,
 6 pcs steak knives · Conjunto 6 facas carne

Ref	€	L (cm)	U.Venta
A 39060	15,40	21	12
B 39061	14,70	21	12



Taco 5 cuchillos CHEF

5 couteau de Bloc · 5 Messer Set
 5 knife block · Taco 5 facas

Ref	€	L (cm)	U.Venta
39064	65,00	20	1

COMPOSICIÓN (6 pcs.):

- * Cuchillo Chef 21 cm (39021)
- * Cuchillo de cocina de 10 cm (39110)
- * Cuchillo de cocina de 16 cm (39116)
- * Cuchillo deshuesador 14 cm (39014)
- * Cuchillo jamonero 20 cm (39020)
- * Chaira (39010)

COMPOSICIÓN (8 pcs.):

- * Cuchillo Chef 21 cm (39021)
- * Cuchillo de cocina de 10 cm (39110)
- * Cuchillo de cocina de 16 cm (39116)
- * Cuchillo deshuesador 14 cm (39014)
- * Cuchillo jamonero 20 cm (39020)
- * Cuchillo pan (39027)
- * Tenedor trinchar (39017)
- * Chaira (39010)



Taco 6 / 8 piezas

6/8 pcs bloc · Messerhalter Set, 6/8-tlg
 6/8 pc bloc · Taco 6/8 peças

Ref	€	Piezas	U.Venta
39000	131,50	6	1
39001	160,90	8	1

COMPOSICIÓN:

- * Cuchillo de cocina de 10 cm (39110)
- * Cuchillo de cocina de 18 cm (39118)
- * Cuchillo de cocina de 25 cm (39125)
- * Cuchillo deshuesador 14 cm (39014)
- * Cuchillo jamonero 20 cm (39020)
- * Cuchillo Chef 25 cm (39025)
- * Tenedor trinchar (39017)
- * Macheta (39015)
- * Chaira (39010)



Maleta 9 piezas

9 pcs mallette de chef · Messertasche, 9-tlg
 9 pc cook's case · Mala 9 peças

Ref	€	U.Venta
39004	347,60	1

New

6 pcs



Set de cuchillos chuleteros

Set de couteaux à viande · Filetmesser-Set
 Cutlet knife set · Conjunto de facas para carne

Ref	€	cm	U.Venta
38240	15,30	10,5	1

- Set de 6 cuchillos chuleteros microdentados fabricados en acero inoxidable de gran calidad.
- Gran resistencia y durabilidad, ideal para el uso diario. Diseñado especialmente para cortar todo tipo de carnes.
- Mango ergonómico de madera de gran resistencia y durabilidad con líneas redondeadas que ofrecen un agarre cómodo y seguro.
- Medidas: 21,5 cm de longitud | tamaño de la hoja: 10,5 cm

- Ensemble de 6 couteaux à viande micro-dentés fabriqués en acier inoxydable de grande qualité.
- Grande résistance et durabilité, parfaits pour un usage quotidien. Spécialement conçus pour couper tous types de viandes.
- Manche ergonomique en bois extrêmement résistant et durable avec des lignes arrondies qui confèrent une prise en main confortable et sûre.
- Dimensions : 21,5 cm de longueur | taille de la lame : 10,5 cm.

- Set of 6 micro serrated steak knives made of high quality stainless steel
- Extremely strong and durable, perfect for daily use Specially designed for cutting all kinds of meat
- It has an extremely strong and durable ergonomic wooden handle with curved lines that give a comfortable and safe grip.
- Measurements: 21.5 cm long | blade size: 10.5 cm.

PROFESIONAL

Colección

54-58 MOLYBDÄNSTAHL Mango Antideslizante
 HRc X 45 Cr Mo V 15 Non-slip long handle knives Dishwasher

Acero inoxidable al cromo-molibdeno-vanadio
 Chrome-molybdenum-vanadium stainless steel

ES

- Cuchillo estampado
- Fabricado en acero inoxidable al cromo-molibdeno-vanadio X 45 Cr Mo V 15. Dureza de 54-58 HRc
- Cuchillo estable, fuerte y de gran durabilidad
- Mango ergonómico antideslizante, tacto suave Soft Touch

FR

- Couteau estampé
- Fabriqué en acier inoxydable au chrome-molybdène-vanadium X 45 Cr Mo V 15. Dureté de 54-58 HRc
- Couteau stable, robuste et d'une grande durabilité
- Manche ergonomique antidérapant, toucher doux Soft Touch

EN

- Stamped Knife
- Made of X 45 Cr Mo V 15 chromium-vanadium stainless steel. 54-58 HRc Hardness
- A stable, strong and durable knife
- Non-slip ergonomic handle, smooth Soft Touch feel



Cuchillo CHEF

Couteau de chef · Messer Chef
 Cook's knife · Faca Chef

Ref	€	cm	U.Venta
49016	6,90	16	12
49021	10,20	21	12
49025	12,00	25	12
49030	13,00	30	12



Cuchillo cocina

Couteau de cuisine · Küchenmesser
 Kitchen knife · Faca cozinha

Ref	€	cm	U.Venta
49110	4,80	10	12
49112	4,80	12	12
49116	5,60	16	12
49121	7,20	21	12



Cuchillo patatero

Couteau office · Gemüsemesser
 Paring knife · Faca batatas

Ref	€	cm	U.Venta
49185	4,30	8,50	12



Cuchillo deshuesador

Couteau à désosser · Ausbeinmesser
 Boning knife · Faca desossador

Ref	€	cm	U.Venta
49014	5,30	14	12



Cuchillo jamonero

Couteau à jambon · Schinkenmesser
 Ham knife · Faca de presunto

Ref	€	cm	U.Venta
49024	8,20	26	12



Cuchillo pan

Couteau à pain · Brotmesser
 Bread knife · Faca de pão

Ref	€	cm	U.Venta
49027	7,40	21	12



Tenedor de trinchar

Fourchette de chef · Tranchiergabel
 Cook's fork · Garfo de trinchar

Ref	€	cm	U.Venta
49017	6,40	18	12



Cuchillo Santoku

Couteau Santoku · Messer Santoku
 Santoku knife · Faca Santoku

Ref	€	cm	U.Venta
49210	6,40	10	12
49212	7,80	12	12
49216	10,70	16	12

CERAMIC

Colección

CZ 87 Mango Antideslizante
 Zirconia HRc Non-slip long handle knives Dishwasher

ES

- Mango ergonómico antideslizante, con un diseño moderno e innovador.
- Resistentes, ligeros e higiénicos.
- NO oxida los alimentos.
- El filo se mantiene hasta diez veces más que los cuchillos convencionales.

FR

- Manche ergonomique antidérapant, le tout avec un design moderne et novateur.
- Résistants, légers et hygiène.
- NO oxyde alimentaire.
- Le tranchant reste aiguisé jusqu'à dix fois plus longtemps que les couteaux conventionnels.

EN

- Ergonomic non-slip handles, modern and innovative design.
- Resistant, light and hygiene.
- NO oxidizes food.
- The edge remains sharp up to ten times longer with conventional knives.



Con funda protectora
 With protective sheath



Apto para cuchillos cerámicos e inoxidables
 Suitable for knives ceramic and stainless

Chaira DIAMANTE

Fusil à affûter · Wetzstahl
 Sharpening steel · Fusil

Ref	€	cm	U.Venta
39075	35,60	21	1

Cuchillo cocina

Couteau de cuisine · Küchenmesser
 Kitchen knife · Faca cozinha

	Ref	€	cm	U.Venta
A	39208	10,70	8	1
B	39210	11,70	10	1
C	39212	19,80	12	1
D	39215	25,70	15	1
E	39218	38,10	18	1
F	39213	23,80	12	1

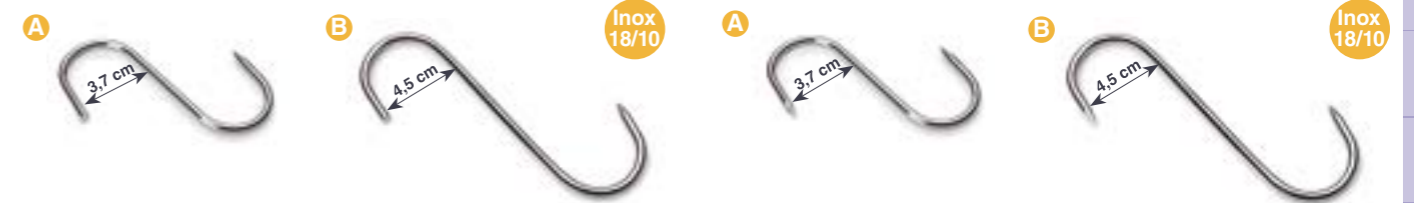

6 ganchos carnicero 1 punta

6 crochets de boucher 1 conseil · 6-Tlg Metzgerhaken, 1 spitze
 6 butchers hook 1 point · 6 ganchos de carnicero 1 punta

	Ref	€	Ø (mm)	L (cm)	U.Venta
A	39043	11,70	5	12,5	4
B	39044	18,10	5	18,5	1

6 ganchos carnicero 2 puntas

6 crochets de boucher 2 conseils · 6-Tlg Metzgerhaken, 2 spitzen
 6 butchers hook 2 points · 6 ganchos de carnicero 2 puntas

	Ref	€	Ø (mm)	L (cm)	U.Venta
A	39047	11,80	5	12,5	4
B	39048	18,30	5	18,5	1

CORTAQUESOS

Colección

Acero inoxidable 54-58
X 50 Cr Mo V 15 HRc
Acero inoxidable al cromo-molibdeno-vanadio
Chrome-molybdenum-vanadium stainless steel

ES

- Cuchillos de hoja recta y acodada (39100) / hoja recta (39101) fabricados en acero inoxidable de alta calidad.
- Diseñados para cortar en diferentes tamaños y formas cualquier tipo de queso, ofreciendo un corte preciso, rápido y seguro.
- 39100: Doble empuñadura ergonómica de polioximetileno (POM) con remaches de acero inoxidable.
- 39101: Doble empuñadura ergonómica de polipropileno texturizado y antideslizante.
- Garantizan un agarre cómodo y eficaz.
- Se precisa de menor fuerza que los cortes con cuchillos convencionales.

FR

- Couteau à lame droite et coudée (39100) / lame droite (39101) fabriquées en acier inoxydable de grande qualité.
- Conçu pour couper en différentes tailles et formes tous types de fromage, offrant une découpe précise, rapide et sûre.
- 39100: Double manche ergonomique en polypropylène (POM) avec rivets en acier inoxydable.
- 39101: Double manche ergonomique en polypropylène texturé et antidérapant.
- Garantit une prise en main pratique et efficace.
- Requiert moins de force que pour les coupes réalisées avec des couteaux conventionnels.

EN

- Knife with a straight offset blade made of high quality stainless steel .
- Designed to slice any type of cheese into different sizes and shapes, cutting it accurately, quickly and safely.
- 39100: Ergonomic polyoxymethylene (POM) double handle with stainless steel rivets.
- 39101: Textured non-slip polypropylene double handle.
- Guarantees a comfortable, effective grip.
- Requires less strength than with traditional knives.

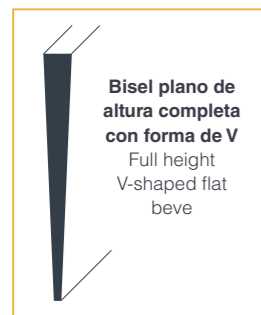

Bisel plano de altura completa con forma de V
Full height V-shaped flat bevel

Taper Grinding

Reducción uniforme de la hoja desde el lomo consiguiendo un filo fuerte y duradero.
Gradually reduction width from the spine resulting in a strong and durable cutting edge.

New

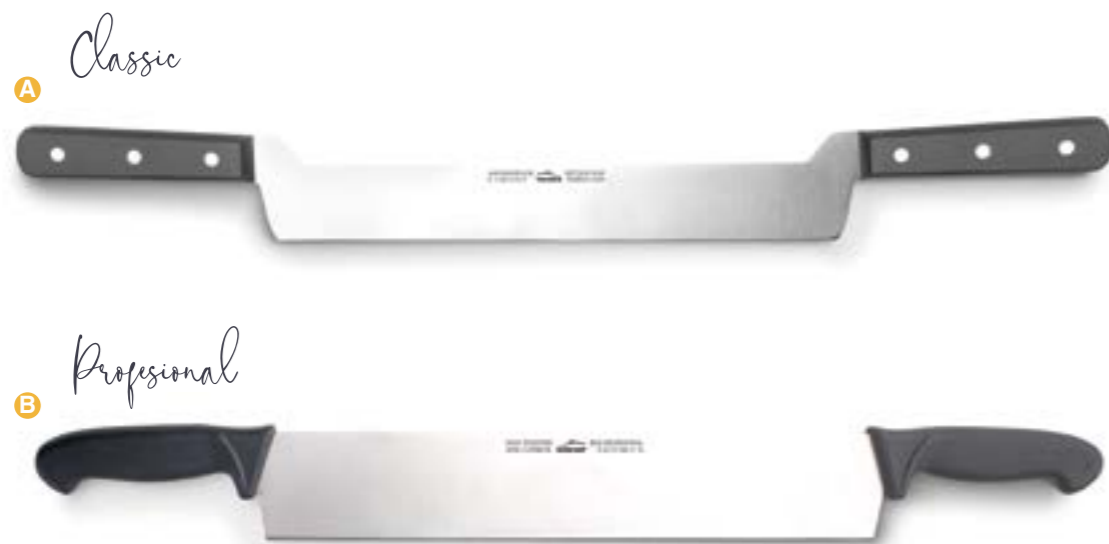

Cuchillo cortaquesos

Couteau à fromage · Käseschneidemesser
Cheese slicing knife · Faca para cortar queijo

	Ref	€	cm	U.Venta
A	39100	45,20	30	1
B	39101	41,50	40	1

TIJERAS

Colección

Inox



Tijeras para aves BLACK

Ciseaux à volaille · Geflügelschere
Poultry shears · Tesouras para aves

Ref	€	cm	U.Venta
60001	18,80	7,5x27	12



Ambidiestro
Ambidextrous

Sistema de cierre de seguridad
Safety closure system

Hojas microdentadas curvadas, extremadamente afiladas y duraderas

Micro-serrated curved blades that are extremely sharp and long-lasting



Tijeras para aves INOX

Ciseaux à volaille · Geflügelschere
Poultry shears · Tesouras para aves

Ref	€	L (cm)	U.Venta
60066	35,20	25	1



Protector y cepillo de limpieza
Protector and cleaning brush



Tijeras 5 cortes

Ciseaux 5 coupe · 5-fach Schneideschere
5 Cuts vegetable scissor · Tesouras 5 cortes

Ref	€	cm	U.Venta
60022	8,50	27x13x3	6



Soporte magnético
Magnetic holder



Tijeras de cocina MAGNETIC

Ciseaux pour cuisine · Küchenschere
Kitchen shears · Tesouras de cozinha

Ref	€	L (cm)	U.Venta
60059	10,00	21,5	6

- 1.- Tijeras · Scissors
- 2.- Abrebotellas · Unscrew
- 3.- Cascanueces · Nut cracker

50-54
HRc



Tijeras profesional INOX

Ciseaux profesional · Geflügelschere Profesional
Professional scissors · Tesouras profesional

Ref	€	cm	U.Venta
38010	21,80	7,0x20	12



2 en 1



Tijera-desescamador

Ciseaux ecailleur · Schere-Fischentschupper
Scissors-scalper · Tesoura-raspador

Ref	€	L (cm)	U.Venta
60061	5,90	23,00	1



Tijeras de cocina GREY

Ciseaux pour cuisine · Küchenschere
Kitchen shears · Tesouras de cozinha

Ref	€	cm	U.Venta
60018	10,70	8,5x21	1
60023	10,80	8,5x24	1

SOPORTES CUCHILLOS

Colección



ES

- Potente imán en el interior para sujetar con seguridad los cuchillos, tijeras y otros artículos metálicos.
- Incluyen un set de montaje para instalar el soporte de cuchillos sobre cualquier tipo de pared.

FR

- Puissant aimant à l'intérieur pour tenir en toute sécurité les couteaux, les ciseaux et tout autre ustensile métallique.
- Inclut un set de montage pour installer le support à couteaux sur tout type de mur.

EN

- It has a powerful magnet inside for safely holding knives, scissors or other metal items.
- Installation hardware for mounting the support on any kind of wall is included.

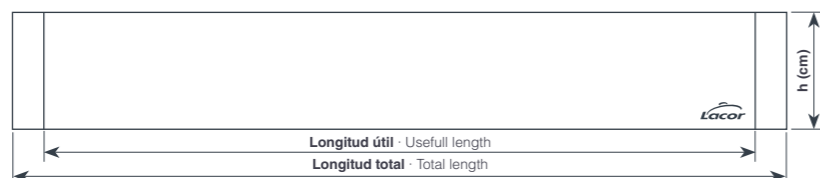

Madera caucho
Rubber wood

Potente imán
Powerful magnet



Parte trasera del soporte · Back of the support

Soporte magnético cuchillos WOOD

Support magnétique pour couteaux · Magnethalterung für Messer
Magnet support for knives · Suporte magnético de facas

Ref	€	Total (cm)	h (cm)	Útil (cm)	U.Venta
39108	27,10	36	6	33	1
39109	31,70	45	6	42	1

Potente imán
Powerful magnet

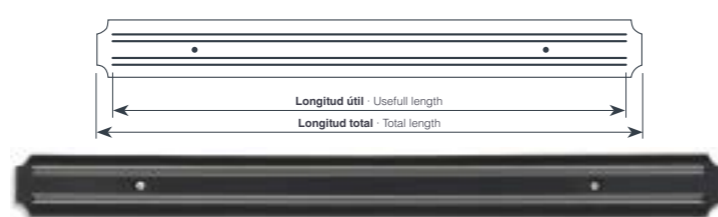

Soporte magnético cuchillos BLACK

Support magnétique pour couteaux · Magnethalterung für Messer
Magnet support for knives · Suporte magnético de facas

Ref	€	Total (cm)	Útil (cm)	U.Venta
39008	8,90	38	35,0	12
39009	10,80	55	52,3	12

TACOS CUCHILLOS

Colección



New

ES

- Bloques cilíndricos fabricados en polipropileno con recubrimiento TPR y acabado en color blanco mate (39037) / metalizado (39038).
- Diseñados para almacenar cuchillos de filo liso, filo dentado y tijeras.
- Aptos para cuchillos de hasta 20 cm (39037) / 21 cm (39038) de longitud de hoja.
- Varillas interiores de fibras de polipropileno (39037).
- Las ranuras separan los bordes de los filos sin tocarse ni rayarse entre sí (39038).
- Protegen los bordes de los filos y mantiene los cuchillos más afilados durante más tiempo.
- Máxima estabilidad y seguridad.
- Desmontables para facilitar la limpieza. Aptos para el lavavajillas.

FR

- Bloc cylindrique fabriqué en polypropylène avec un revêtement TPR et une finition blanc mat (39037) / métallisé (39038).
- Conçu pour ranger des couteaux à fil lisse, à fil denté et des ciseaux.
- Compatibles avec des couteaux jusqu'à 20 cm (39037) / 21 cm (39038) de longueur de lame.
- Tiges intérieures en fibre de polypropylène (39037).
- Les rainures séparent les bords des fils, évitant ainsi qu'il se touchent ou se rayent entre eux (39038).
- Protège les bords des fils et maintient les couteaux plus affilés pendant plus longtemps.
- Máxima estabilidad y seguridad.
- Démontables pour faciliter le nettoyage. Lavables au lave-vaisselle.

EN

- Cylindrical polypropylene knife holder with TPR coating and matte white finish (39037) / metallised (39038).
- Designed to hold smooth-edged knives, serrated knives and scissors.
- Suitable for knives with blade lengths up to 20 cm (39037) / 21 cm (39038).
- Inner polypropylene fibre rods. (39037).
- The slots separate the edges of the blades and prevent them from touching or scratching each other (39038).
- Protects cutting edges and keeps knives sharper for longer.
- Maximum stability and safety.
- Removable for easy cleaning. Dishwasher safe.

White



Varillas de fibras
Fibre rods

A



TitanPro



Ranuras separadoras
Slots separators

B



Taco de cuchillos

Bloc à couteaux · Messerblock
Knife block · Taco para facas

Ref.	€	Ø (cm)	h (cm)	U.Venta
A 39037	14,50	11	22,0	1
B 39038	13,60	13	22,8	1

AFILADORES CUCHILLOS

Colección



New

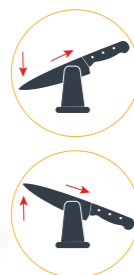

Primera fase
Afilado grueso
First phase
Coarse sharpening

Segunda fase
Pulido final o
afilado diario
Second phase
Final honing or
daily sharpening

Afilador de cuchillos VERTICAL

Affûteuse de couteaux · Schärmaschine
Knives sharpener · Afiador de facas

Ref	€	cm	h (cm)	U.Venta
39263	10,60	9,5x5,5	9,5	1

- Diseñado para alar y pulir cuchillos de lo liso o dentado.
- Dos fases de alado: primera fase para un alado grueso, para cuchillos más deteriorados. Segunda fase para el pulido final o alado diario.
- Ángulo de alado regulable: garantiza un lo renovado y efectivo.
- 100% preciso y seguro. Tamaño compacto. Base antideslizante.

- Conçu pour aiguiser et polir des couteaux à fil lisse ou denté.
- Deux phases d'aiguisage : première phase pour un aiguisage épais, pour les couteaux les plus abîmés. Deuxième phase pour le polissage final ou l'aiguisage quotidien.
- Angle d'aiguisage réglable : garantit un fil renoué et efficace.
- 100% précis et sûr. Taille compacte. Base antidérapante.

- Designed for sharpening and honing knives with a smooth or serrated edge.
- Two sharpening phases: first phase for coarse sharpening of blunt blades. Second phase for final honing or daily sharpening.
- Adjustable sharpening angle: guarantees a renewed, much sharper edge.
- 100% precise and safe. Compact size. Non-slip base.

New



Afilador de cuchillos MINI

Affûteuse de couteaux · Schärmaschine
Knives sharpener · Afiador de facas

Ref	€	cm	h (cm)	U.Venta
39264	7,40	10x5,2	4,5	1

- Eficaz afilador manual compacto. Diseño ergonómico.
- 2 ranuras de alado: 1.- Ranura de carburo de tungsteno: afilado grueso para las hojas más deterioradas. 2.- Ranura cerámica: pulido final o afilado diario.
- 2 posiciones de afilado para mayor comodidad.
- Afilado óptimo en pocas pasadas.
- Ligero y manejable: uso cómodo, sencillo y seguro.
- Base antideslizante. Fácil de transportar y guardar.

- Aiguiser manuel compact et efficace. Design ergonomique.
- 2 rainures d'aiguisage: 1.- Rainure en carbure de tungstène : Aiguisage épais pour les lames les plus abîmées. 2.- Rainure céramique : Polissage final ou aiguisage quotidien.
- 2 positions d'aiguisage pour une utilisation plus pratique.
- Aiguisage optimal en quelques mouvements.
- Léger et maniable : utilisation pratique, simple et sûre.
- Base antidérapante. Facile à transporter et à ranger.

- Highly effective, compact manual sharpener. Ergonomic design.
- 2 sharpening slots: 1.- Tungsten carbide slot: coarse sharpening of blunt blades. 2.- Ceramic slot: final honing or daily sharpening.
- 2 sharpening positions for added comfort.
- Optimum sharpening in just a few strokes.
- Lightweight and practical: convenient, simple and safe to use.
- Non-slip base. Easy to transport and store.

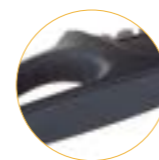

Base antideslizante
Non-slip base



Orientación de afilado
Sharpening orientation



Afilador de cuchillos DUAL

Affûteuse de couteaux · Schärmaschine
Knives sharpener · Afiador de facas

Ref	€	cm	U.Venta
39266	18,70	21,5x4,5x9	1



Afilador de cuchillos eléctrico TitanPRO

Affûteuse de couteaux électrique · Elektrische Schärmaschine
Electric knife sharpener · Afiador de facas electrónico

Ref	€	U.Venta
69341	39,10	1



Ruedas de Alundum blanco
White alundum wheel



Afilador de cuchillos eléctrico ROND

Affûteuse de couteaux électrique · Elektrische Schärmaschine
Electric knife sharpener · Afiador de facas electrónico

Ref	€	U.Venta
69141	32,10	1

- Afila cuchillos de filo liso.
- 2 zonas de afilado: afilado estándar y afilado alta precisión.
- Cada zona consta de: 2 discos de acero de carburo duro (grosso) para vaciar bordes. 2 discos de cerámica fina para terminar el borde.
- Fácil de usar, empuje el filo en un ángulo de 90° con una ligera presión.
- Asa con goma y ranuras para los dedos que proporciona un manejo sencillo y seguro.

- Aigüiseur pour lames lisses.
- 2 zones d'affûtage : affûtage standard et affûtage de haute précision.
- Chaque zone est composée de : 2 disques en acier au carbone dur (épais) pour restaurer le fil. 2 disques en céramique fine pour terminer le fil.
- Facile à utiliser : pousser la lame à un angle de 90° avec une légère pression.
- Poignée avec caoutchouc et rainures pour les doigts qui confère une prise en main simple et sûre.

- Sharpen smooth blade knives.
- 2 sharpening zones: standard sharpening and high precision sharpening.
- Each zone consists of: 2 thick carbide steel rods for cleaning up edges. 2 thin ceramic rods for honing edges.
- Easy to use: push the knife at a 90° angle using light pressure.
- Rubber handle with finger grooves for safe and easy use.

Ref: 69341

Características · Characteristics:
Tensión · Voltage: 220-240 V; 50-60 Hz
Potencia · Power: 60 W
Dimensiones · Sizes: 17x8x10 cm
Peso · Weight: 0,60 kg

- Permiten mantener los utensilios en perfecto estado.
- Diseño elegante, acabado metalizado.
- Dispone de diferentes ranuras para poder afilar distintos tipos de utensilios como cuchillos, tijeras o destornilladores de punta plana.
- El motor gira a la velocidad óptima para que el afilado de los utensilios sea preciso y duradero.
- 100% seguro: en su base se incluyen cuatro ventosas de fijación para evitar que el afilador se mueva durante su uso.

- Permet de maintenir les ustensiles en parfait état.
- Design élégant, finition métallisée.
- Dispose de différentes rainures pour pouvoir aiguiser différents types d'ustensiles tels que des couteaux, des ciseaux ou des tournevis.
- Le moteur tourne à une vitesse optimale pour que l'aiguisage des ustensiles soit précis et durable.
- 100% antidérapant : sa base possède quatre ventouses de fixation pour éviter que l'aigüiseur bouge pendant son utilisation.

- Keeping kitchen utensils in perfect condition.
- Elegant design, metallic finish.
- It has different grooves for sharpening different utensils, like knives, scissors and flat-head screwdrivers.
- The motor spins at the optimal speed for precise and long lasting sharpening.
- 100% safe. There are four suction cups on the base to keep the sharpener from moving during use.

Ref: 69141

Características · Characteristics:
Tensión · Voltage: 220-240 V; 50 Hz
Potencia · Power: 60 W
Dimensiones · Sizes: 173,5x15x9 cm
Peso · Weight: 0,64 kg



Afilador de cuchillos eléctrico PRO

Affûteuse de couteaux électrique · Elektrische Schärmaschine
Electric knife sharpener · Afiador de facas electrónico

Ref	€	U.Venta
69261	124,20	1

Ref: 69261

Características · Characteristics:

Tensión · Voltage: 220-240 V; 50-60 Hz
Potencia · Power: 180 W
Dimensiones · Sizes: 32x11,5x210 cm
Peso · Weight: 2,20 kg

Fase 1 Fase 2 Fase 3



Fase 1: Alta abrasividad · high abrasiveness
Fase 2: Afilado fino · thin sharp
Fase 3: Microafilado · micro-sharp



Afilador de cuchillos eléctrico MOUSE

Affûteuse de couteaux électrique · Elektrische Schärmaschine
Electric knife sharpener · Afiador de facas electrónico

Ref	€	U.Venta
60359	49,10	1

Ref: 60359

Características · Characteristics:

Tensión · Voltage: 220-240 V; 50-60 Hz
Potencia · Power: 180 W
Dimensiones · Sizes: 16x11x7,5 cm
Peso · Weight: 20,56 kg



Cuchillos lisos · Smooth knives
Rejilla salida viruta · Chip outlet grid

ABRELATAS Colección



Altura máx. de lata: 30 cm · Maxime height of caniste: 30 cm

Abrelatas de mesa profesional

Ouvre-boîte de table professionnel · Profe-Dosenöffner für Tisch
Professional table tin opener · Abre-latas de mesa profesional

	Ref.	€	U.Venta
A	63005	128,20	1
B	63015	189,00	1



Abrelatas

Ouvre-boîte · Dosenöffner
Can opener · Abre-latas

	Ref	€	cm	L (cm)	U.Venta
A	62689	26,50	5x4	20	6
B	63038	22,20	5x4	17	1



TABLAS DE CORTE Colección



ES

- **Tabla de corte fabricada en fibra de madera, materiales naturales y ecológicos.**
- **Duradera, resistente, indeformable y anti-bacteriana.**
- **Las fibras de madera ayudan a mantener el filo de los cuchillos afilado durante más tiempo.**
- **Su diseño permite darle un doble uso, tanto para la cocina como para el servicio en mesa y se pueden usar por ambos lados.**
- **GRIPsystem, pies singulares fabricados en silicona para utilizar las tablas en cualquier superficie sin riesgo de deslizamiento.**
- **El orificio es perfecto para colgar la tabla y facilitar su almacenaje.**
- **Fácil de limpiar gracias a su acabado liso, no poroso.**
- **Apta para el lavavajillas.**

FR

- Planche à découper fabriquée en fibres de bois, un matériau naturel et écologique.
- Durable, résistante, indéformable et antibactérienne.
- Les fibres de bois aident à maintenir le fil des couteaux aiguisés plus longtemps.
- Sa forme permet de lui donner un double usage, à la fois pour la cuisine et pour le service à table, et elle est utilisable des deux côtés.
- **GRIPsystem**, pieds exclusifs en silicone pour utiliser les planches sur n'importe quelle surface sans risque de glisser.
- L'orifice est parfait pour suspendre la planche et faciliter son rangement.
- Facile à nettoyer grâce à sa finition lisse, non poreuse.
- Elle est apte pour le lave-vaisselle.

EN

- Chopping board made from wood fibre, a natural and eco-friendly material.
- Durable, resistant, anti-bacterial and its shape doesn't warp.
- The wood fibres help keep the knife blade sharper for longer.
- Its design allows you to use both for the kitchen and for serving food on the table.
- **GRIPsystem**, exclusive feet made of silicone to use the boards on any surface without risk of slipping.
- The hole is perfect for hanging the board and it makes it easier to store.
- It's easy to clean thanks to its smooth, non-porous finish.
- It's suitable for washing machines.



Tabla de corte BLACK

Planche à découper · Schneidebrett
Cutting board · Tábua de corte

Ref	€	cm	e (mm)	U.Venta
60580	18,20	30x21,5	6	1
60581	24,50	37x27,5	6	1
60582	34,80	44x32,5	6	1



Tabla de corte NOGAL

Planche à découper · Schneidebrett
Cutting board · Tábua de corte

Ref	€	cm	e (mm)	U.Venta
60586	16,70	26,5x19,5	6	1
60587	21,10	30x23,5	6	1
60588	32,90	40x30	6	1

TABLAS DE CORTE MADERA

Colección



ES

- Ideales para cortar todo tipo de alimentos.
- Perfectas para colocar sobre la encimera de la cocina.
- Madera tratada con un revestimiento protector antibacteriana.
- Diseñada para cuidar y conservar el filo de los cuchillos.
- Ligeras y resistentes. Higiénicas y fáciles de limpiar.

FR

- Idéales pour couper tout type d'aliments.
- Parfaites pour installer sur le plan de travail de la cuisine.
- Bois traité avec un revêtement protecteur et antibactérien.
- Conçues pour prendre soin et préserver le fil des couteaux.
- Légères et résistantes. Hygiéniques et faciles à nettoyer.

EN

- Ideal for cutting any type of food.
- Perfect for placing on kitchen counters.
- The wood is treated with a protective antibacterial finish.
- Designed to conserve and protect the edges of your knives.
- Lightweight and strong. Hygienic and easy to clean.

Bambú
Bamboo



Tabla de corte para pan

Planche à découper pain · Schneidebrett brot
Bread cutting board · Tábua de corte pão

Ref	€	cm	h (cm)	U.Venta
60487	28,70	40x30	2	1

Bambú
Bamboo



Tabla de corte pan oval

Planche à découper pain ovale · Schneidebrett oval brot
Oval bread cutting board · Tábua de corte pão oval

Ref	€	cm	h (cm)	U.Venta
60491	35,80	40x27	3	1

Bambú
Bamboo



Tabla de corte pan

Planche à découper pain · Schneidebrett brot
Bread cutting board · Tábua de corte pão

Ref	€	cm	h (cm)	U.Venta
60495	22,60	50x15	2	1

Bambú
Bamboo



Tabla de corte DUAL

Planche à découper · Schneidebrett
Cutting board · Tábua de corte

Ref	€	cm	h (cm)	U.Venta
60492	36,60	39,5x38	4	1

Bambú
Bamboo



Set 3 tablas de corte

Set 3 planches à découper · Set 3 Schneidebrett
3 cutting boards set · Conjunto 3 tábuas de corte

Ref	€	cm	U.Venta
60523	17,80	20x15	1
		28x22	
		33x25	

Madera
caucho
Rubber
wood

Las fibras colocadas verticalmente,
mantienen el filo de los cuchillos

The fibres placed vertically, maintain the edge of the knives



Tabla de corte RUBBER WOOD

Planche à découper · Schneidebrett
Cutting board · Tábua de corte

Ref	€	cm	h (cm)	U.Venta
60488	35,00	33x25	4	1
60485	68,40	53,3x32,8	4	1

Madera
caucho
Rubber
wood

Inox

- Práctica tabla de corte con una o dos cubetas de acero inoxidable ocultas completamente extraíbles.
- Las fibras colocadas verticalmente ayudan a mantener el filo de los cuchillos afilado durante más tiempo.
- Tabla de corte tratada con un revestimiento protector y anti-bacteriana.
- Cubeta extraíble para recoger los alimentos cortados.
- Cubeta apta para el horno (hasta 250°C) y el lavavajillas.
- Pies antideslizantes, garantiza la estabilidad de la tabla durante el corte.

- Planche à découper pratique avec un ou deux bac en acier inoxydable totalement extractibles.
- Les fibres placées verticalement aident à maintenir le fil de la lame des couteaux aiguisés plus longtemps.
- Planche à découper traitée avec un revêtement de protection et antibactérien.
- Bacs extractibles pour accueillir les aliments coupés.
- Bacs aptes pour le four (jusqu'à 250 °C) et le lave-vaisselle.
- Pieds antidérapants qui garantissent la stabilité de la planche à découper pendant la découpe.

- Handy cutting board with one or two completely removable stainless steel trays.
- The fibres are arranged vertically to help knife blades retain their sharpness for longer.
- Cutting board treated with a protective and anti-bacterial coating.
- Removable tray for collecting chopped food.
- Tray is oven-safe (up to 250°C) and dishwasher-safe.
- Non-slip feet ensure the board remains stable when cutting.

A



Tabla de corte COLLECT GN 2/3

Planche à découper · Schneidebrett
Cutting board · Tábua de corte

Ref	€	Tabla (cm)	Cubeta (cm)	Cubeta (L)	U.Venta
60592	71,00	41,5x34x7	-	-	1
A *66540Z	21,70	-	35,4x32,5x4	3,50	1

* Apta cubeta inox 18/10 (66540) · Suitable for 18/10 stainless steel tray (66540)

A



Tabla de corte COLLECT 2xGN 1/2

Planche à découper · Schneidebrett
Cutting board · Tábua de corte

Ref	€	Tabla (cm)	Cubeta (cm)	Cubeta (L)	U.Venta
60591	99,50	61,5x34x7	-	-	1
A *66240Z	11,50	-	26,5x32,5x4	2,5 x 2	1

* Apta cubeta inox 18/10 (66240) · Suitable for 18/10 stainless steel tray (66240)

Pies antideslizantes
Non-slip feet



Bambú
Bamboo



Tabla de corte COLLET HOME

Planche à découper · Schneidebrett
Cutting board · Tábua de corte

Ref	€	Tabla (cm)	Cubeta (cm)	U.Venta
60594	29,80	35x29x4	-	1
A R60594A	4,80	-	34x26,5x2	1

Base de cristal de Ø25 cm
Ø25 cm glass base

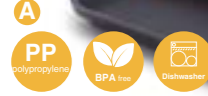

Cristal
Glass

Acacia
wood

Set cuchillos para queso

Jeu de couteaux pour le fromage · Set von Messern für Käse
Knives set · Jogo de facas para queijo

Ref	€	Ø (cm)	h (cm)	U.Venta
60072	47,00	25	5	1

Para cortar, presentar y conservar
To cut, present and preserve



AS
plastic

BPA free

Acacia
wood

Quesera KEEP

Plateau à fromage avec cloche · Käseglocke
Cheese dome · Queijeira

Ref	€	cm	h Total (cm)	U.Venta
62004	25,30	28,5x18,5	10	1

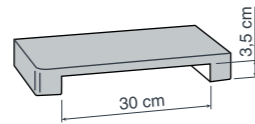

Apertura por ambos lados
Opening on both sides

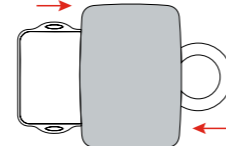

Ideal para colocar platos o bandejas en ambos lados
Ideal for placing plates or trays on both sides



Pies antideslizantes
Non-slip feet

Bambú
Bamboo

Tabla de corte COLLET

Planche à découper · Schneidebrett
Cutting board · Tábua de corte

Ref	€	cm	h (cm)	U.Venta
60595	30,30	40x26	5	1

- Fabricada en robusta madera de acacia.
- Superficie de corte en cristal con un Ø25 cm.
- Incluye 4 cuchillos fabricados en acero inoxidable con mango de madera.
- Ideal para cortar quesos y presentarlos sobre la misma.

- Fabriquée en bois d'acacia robuste.
- Surface de découpe en verre avec un Ø de 25 cm.
- Inclut 4 couteaux fabriqués en acier inoxydable avec manche en bois.
- Idéale pour couper le fromage et le présenter à table.

- Made of sturdy acacia wood.
- Ø25cm glass cutting surface.
- Includes 4 stainless steel knives with wooden handles.
- Ideal for cutting and serving cheese.



- Quesera compuesta por base de madera de acacia natural y tapa de plástico, libre de BPA.
- Práctica y funcional; corta, presenta y conserva los alimentos en las mejores condiciones.
- Tapa en forma de campana con pomo para facilitar su manipulación.

- Plateau à fromage composé d'un plateau en bois d'acacia naturel et d'une cloche en plastique, sans BPA.
- Pratique et fonctionnel ; coupez, présentez et conservez les aliments dans les meilleures conditions.
- Cloche avec pommeau pour faciliter sa prise en mai

- Cheese dome with a natural acacia wood base and a plastic cover. BPA free.
- Practical and functional. Cut, present and conserve food under the best conditions.
- The cover is bell shaped and has a handle so it's easy to use.



TABLAS DE CORTE PP / PE

Colección



ES

- Ideales para cortar todo tipo de alimentos.
- Perfectas para colocar sobre la encimera de la cocina.
- Ligeras y resistentes.
- Antibacterianas.
- Higiénicas y fáciles de limpiar.
- Aptas para el lavavajillas.

FR

- Idéales pour couper tout type d'aliments.
- Parfaites pour installer sur le plan de travail de la cuisine.
- Légères et résistantes.
- Antibactérien.
- Hygiéniques et faciles à nettoyer.
- Aptes pour le lave-vaisselle.

EN

- Ideal for cutting any type of food.
- Perfect for placing on kitchen counters.
- Lightweight and strong.
- Antibacterial.
- Hygienic and easy to clean.
- Dishwasher safe.

Asa para facilitar su manejo
Tope de silicona antideslizante
Antibacteriana
Handle for easy handling
Non-slip silicone stopper
Antibacterial



PP
polypropylene



PP
polypropylene



PP
polypropylene

Set 3 tablas de corte GREY

Set 3 planches à découper · Set 3 Schneiderbrett
3 cutting boards set · Conjunto 3 tábuas de corte

Ref	€	cm	U.Venta
60500	13,20	20x15 30x20 35x25	1

Set 3 tablas de corte OCEAN

Set 3 planches à découper · Set 3 Schneiderbrett
3 cutting boards set · Conjunto 3 tábuas de corte

Ref	€	cm	U.Venta
60555	13,20	20x15 30x20 35x25	1

Tabla de corte

Planche à découper · Schneidebrett
Cutting board · Tábua de corte

Ref	€	cm	h (cm)	U.Venta
60501	8,10	30x18	1	1
60502	11,10	36x22	1	1
60503	14,90	42x25,5	1	1



Tacos antideslizantes
Non slip plugs



Tabla de corte polietileno
Planche à découper en polyéthylène · Schneidebret Polyethylen
Polyethylene cutting board · Tábua de corte polietileno

GN 1/4 - 265x162 mm				GN 1/2 - 325x265 mm				GN 1/1 - 530x325 mm				600x400 mm			
Ref	€	h (mm)	U.Venta	Ref	€	h (mm)	U.Venta	Ref	€	h (mm)	U.Venta	Ref	€	h (mm)	U.Venta
60569	10,80	20	6	60455	21,10	20	6	60456	41,80	20	1	60457	58,90	20	1
				60405	31,00	30	6	60406	62,30	30	1	60407	87,20	30	1
								60575	120,90	50	1				



Tacos antideslizantes
Non slip plugs



- Pescado · Fish** ■
- Verduras+frutas · Vegetables+Fruits** ■
- Embutidos · Cold cred meat** ■
- Carne · Meat** ■
- Aves · Poultry** ■
- Varios · Various** ■

Tabla de corte
Planche à découper · Schneidebrett
Cutting board · Tábua de corte

GN 1/4 - 265x162 mm				GN 1/2 - 325x265 mm				GN 1/1 - 530x325 mm				600x400 mm			
Ref	€	h (mm)	U.Venta	Ref	€	h (mm)	U.Venta	Ref	€	h (mm)	U.Venta	Ref	€	h (mm)	U.Venta
60570	10,80	20	1	60470	21,10	20	1	60475	41,60	20	1	60600	59,20	20	1
60571	10,80	20	1	60471	21,10	20	1	60476	41,60	20	1	60601	59,20	20	1
60572	10,80	20	1	60472	21,10	20	1	60477	41,60	20	1	60602	59,20	20	1
60573	10,80	20	1	60473	21,10	20	1	60478	41,60	20	1	60603	59,20	20	1
								60576	117,80	50	1				
60574	10,80	20	1	60474	21,10	20	1	60479	41,60	20	1	60604	59,20	20	1
60577	10,80	20	1	60480	21,10	20	1	60481	41,60	20	1	60605	59,20	20	1

PE-500 (HD-HMW) High Molecular AA Weight Polyethylene

Especial para preparar comidas que no contengan alérgenos
Identifiquela rápidamente por su intenso color morado
Specially made for making food that contains no allergens
Identify it quickly by its deep purple colouring



Tabla de corte antialérgica
Planche à découper · Schneidebrett
Anti-allergy cutting board · Tábua de corte

GN 1/2 - 325x265 mm				GN 1/1 - 530x325 mm				600x400 mm			
Ref	€	h (mm)	U.Venta	Ref	€	h (mm)	U.Venta	Ref	€	h (mm)	U.Venta
60521	24,00	20	1	60522	48,00	20	1	60606	58,70	20	1

PE-500 (HD-HMW) High Molecular AA Weight Polyethylene

Robusta y alta durabilidad
Antibacteriana
Robust and high durability
Antibacterial



Tabla de corte COLLECT GN 2/3
Planche à découper · Schneidebrett
Cutting board · Tábua de corte

Ref	€	Tabla (cm)	Cubeta (cm)	Cubeta (L)	U.Venta
60593	99,40	41x34x6,5	-	-	1
*66540Z	21,70	-	35,4x32,5x4	3,5	1

* Apta cubeta Inox 18/10 (66540) · Suitable for 18/10 stainless steel tray (66540)

- Práctica tabla de corte con una cubeta GN 2/3 de acero inoxidable oculta completamente extraíble.
- Fabricada en polietileno de alta densidad de color blanco.
- Segura, ligera e higiénica, no absorbe humedad y evita la proliferación de bacterias.
- Gracias a su superficie suave, protege las hojas de los cuchillos.
- Cubeta extraíble (35,4x32,5x4 cm) para recoger los alimentos cortados.
- Cubeta apta para el horno (hasta 250°C) y el lavavajillas.
- Pies antideslizantes, garantiza la estabilidad de la tabla durante el corte.
- Resistente a los cortes y los arañazos.

- Planche à découper pratique avec un bac GN 2/3 en acier inoxydable totalement extractibles.
- Fabriquée en polyéthylène de haute densité de couleur blanche.
- Sûre, légère et hygiénique, elle n'absorbe pas l'humidité et évite la prolifération des bactéries.
- Grâce à sa surface douce, elle protège les lames des couteaux.
- Bacs extractibles (35,4x32,5x4 cm) pour accueillir les aliments coupés.
- Bacs aptes pour le four (jusqu'à 250 °C) et le lave-vaisselle.
- Pieds antidérapants qui garantissent la stabilité de la planche à découper pendant la découpe.
- Résistante aux coupures et aux rayures.

- Handy cutting board with one completely removable stainless steel GN 2/3 tray.
- Made of white high-density polyethylene.
- Safe, light and hygienic, it does not absorb moisture and prevents the growth of bacteria.
- It protects knife blades thanks to its smooth surface.
- Removable tray (35,4x32,5x4 cm) for collecting chopped food.
- Tray is oven-safe (up to 250°C) and dishwasher-safe.
- Non-slip feet ensure the board remains stable when cutting.
- Resistant to cuts and scratches.



Cepillo para tablas de corte
Brosse pour planche à découper · Brush für Schneidebrett
Brush cutting board · Cepilho para tábua de corte

Ref	€	cm	h (cm)	U.Venta
60458	66,30	17x6	10	1

- Para uso de tablas de polietileno profesionales.
- Renueva las tablas, eliminando las rayas o pequeñas grietas.
- Crea una superficie limpia y totalmente lisa.
- Asa ergonómica que permite moverlo con facilidad sobre toda la superficie de la tabla.

- A utiliser sur les panneaux professionnels en polyéthylène.
- Remet à neuf les panneaux en éliminant les rayures ou les petites fissures.
- Crée une surface propre et parfaitement lisse.
- Poignée ergonomique pour un déplacement aisé sur toute la surface de la planche.

- For use on professional polyethylene boards.
- Refurbishes boards, eliminating scratches or small cracks.
- Creates a clean and completely smooth surface.
- Ergonomic handle for easy movement over the entire surface of the board. surface of the board.

New



Soporte tablas de corte
Support pour planches à découper · Schneidbretthalter
Cutting board rack · Suporte para tábuas de cortar

Ref	€	cm	h (cm)	U.Venta
60579	27,90	34x30	27,8	1

Inox
Multifuncional: apto para tablas, bandejas, moldes rígidos, etc.
Multifunctional: suitable for boards, trays, rigid moulds, etc

- Fabricado en varilla de acero inoxidable de gran calidad.
- Diseñado para organizar hasta 6 tablas de corte de 3 cm de espesor.
- Multifuncional: apto para tablas, bandejas, moldes rígidos, etc.
- 4 patas antideslizantes para garantizar una máxima estabilidad.

- Fabriqué en acier inoxydable de grande qualité.
- Conçu pour ranger jusqu'à 6 planches à découper de 3 cm d'épaisseur.
- Multifonctions : apte pour des planches à découper, des plateaux, des moules rigides, etc.
- 4 pieds antidérapants pour garantir une stabilité maximale

- Made of high quality stainless steel rods.
- Designed to hold up to six 3 cm-thick cutting boards.
- Multifunctional: suitable for boards, trays, rigid moulds, etc.
- 4 non-slip feet for maximum stability.

CUBIERTOS

Colección



-  **Cuchara mesa** · Table spoon
-  **Tenedor mesa** · Table fork
-  **Cuchillo mesa** · Table knife
-  **Cuchara postre** · Dessert spoon
-  **Tenedor postre** · Dessert fork
-  **Cuchillo postre** · Dessert knife
-  **Cuchara café** · Coffee spoon
-  **Cuchara moka** · Moka spoon
-  **Tenedor lunch** · Lunch fork
-  **Tenedor pescado** · Fish fork
-  **Pala pescado** · Fish knife
-  **Cazo sopa** · Soup ladle
-  **Cuchara servir** · Serving spoon
-  **Tenedor servir** · Serving fork
-  **Cacillo salsa** · Gravy shovel
-  **Pala pastel** · Cake shovel



Inox

Espesor · Thickness: 1,8 mm

HOTEL

Ref	€	U.Venta	
33101	1,70	12	Cuchara mesa · Table spoon
33102	1,70	12	Tenedor mesa · Table fork
33103	2,80	12	Cuchillo mesa · Table knife
33104	1,40	12	Cuchara postre · Dessert spoon
33105	1,40	12	Tenedor postre · Dessert fork
33106	2,70	12	Cuchillo postre · Dessert knife
33107	1,10	12	Cuchara café · Coffee spoon
33108	0,90	12	Cuchara moka · Moka spoon
33109	1,10	12	Tenedor Lunch · Lunch fork

ARIES

Ref	€	U.Venta	
33401	2,70	12	Cuchara mesa · Table spoon
33402	2,70	12	Tenedor mesa · Table fork
33403	6,00	12	Cuchillo mesa · Table knife
33404	2,70	12	Cuchara postre · Dessert spoon
33405	2,70	12	Tenedor postre · Dessert fork
33406	6,00	12	Cuchillo postre · Dessert knife
33407	1,40	12	Cuchara café · Coffee spoon
33408	1,30	12	Cuchara moka · Moka spoon
33409	1,70	12	Tenedor Lunch · Lunch fork
33410	2,70	12	Tenedor pescado · Fish fork
33411	2,70	12	Pala pescado · Fish knife
33412	10,60	1	Cazo sopa · Soup ladle
33413	6,50	1	Cuchara servir · Serving spoon
33414	6,60	1	Tenedor servir · Serving fork
33415	8,40	1	Cacillo salsa · Gravy shovel
33416	7,20	1	Pala pastel · Cake shovel



Inox 18/10

Espesor · Thickness: 2,5 mm



Dishwasher

CUBERTEROS

Colección



Soporte cubiertos con vasos
Porte couverts avec paniers · Besteckbehälter
Cutlery holder w/cylinder · Sup. talheres com copos

Ref.	€	cm	Orif.	U.Venta
33124	84,70	29x22x26	4	1
33126	104,10	29x22x38	6	1



Vasos inox cubertería
Panier pour porte couvert · Besteckköcher
St. steel cutlery cylinder · Copos p/talheres inox

Ref.	€	h (cm)	U.Venta
33125	7,60	14	6



Contenedor cubiertos
Panier à couverts · Besteckköcher
Cutlery holder · Copos para talheres

Ref	€	Ø (cm)	h (cm)	L	U.Venta
62962	21,00	12	13,6	1,40	1
62963	24,40	12	18,7	2,00	1

4 compartimentos
4 compartments
Hueco · Hollow: 11x25x9 cm



Cubertero GN 1/1
Range-couverts · Besteckkasten
Cutlery holder · Bandeja para talheres

Ref	€	cm	h (cm)	U.Venta
33121	11,20	52,5x32	9,5	1

- Recipiente para cubiertos en color negro de polipropileno.
- Ideal para organizar y guardar los cubiertos e utensilios de la cocina.
- No se deforma con el peso de los cubiertos.
- Cómodo de transportar gracias a sus asas laterales.
- Fondo redondeado para un fácil mantenimiento.
- Apilable.

- Pot à couverts en polypropylène noir.
- Idéal pour organiser et ranger les couverts et les ustensiles de cuisine.
- Il ne se déforme pas avec le poids des couverts.
- Confortable à transporter grâce à ses poignées latérales.
- Fond arrondi pour un entretien facile.
- Empilable.

- Black polypropylene cutlery container.
- Ideal for organizing and storing cutlery and kitchen utensils.
- It does not deform with the weight of the cutlery.
- Comfortable to transport thanks to its side handles.
- Rounded bottom for easy maintenance.
- Stackable.

A



Trenzados
Braided

B



C



Bastidor cromado reforzado
Reinforced chrome frame

4 compartimentos
4 compartments

Cubertero RATTAN PP
Range-couverts · Besteckkasten
Cutlery holder · Bandeja para talheres

Ref	€	cm	h (cm)	Compart.	U.Venta
A 63484	8,40	27x10	4,5	1	1
B 63485	8,40	Ø12	15,0	1	1
C 63491	74,80	53x32,5	9,0	4	1

CHAFING DISH

Colección

Inox 18/10

Vitro Electric Gas Induction



ES

- Tapa con descenso amortiguado para un cierre suave.
- Tapa extraíble verticalmente para su limpieza.
- Visor de cristal.
- Las gotas de condensación retornan a la cubeta.
- Salsera lateral para la sujeción de cacillos o espumaderas.
- Disponibilidad de aro complementario para el empleo de placa de inducción.

FR

- Couvercle avec descente amortie pour une fermeture en douceur.
- Couvercle peut s'extraire verticalement pour un nettoyage aisé.
- Écran en verre.
- Les gouttelettes de condensation retombent dans la cuvette.
- Saucière latérale pour la fixation de louches ou d'écumoirs.
- Disponibilité d'anneaux complémentaires pour l'utilisation de plaques à induction.

EN

- Cover with damping seal for smooth closure.
- Cover can be removed vertically for easy cleaning.
- Glass display.
- The condensation droplets return to the receptacle.
- Lateral sauceboat for holding scoops and skimmers.
- Availability of additional rings for the use of induction hobs.



Chafing dish GN 1/1 LUXE

Bain marie GN 1/1 · Chafing Dish, GN-Einsatz 1/1
GN 1/1 chafing dish · Chafing dish GN 1/1

Ref	€	cm	h (cm)	L	U.Venta
69091	1.010,60	47x59,5	43,0	9,0	1



Cuerpo chafing dish GN 1/1 LUXE

Corps bain marie GN 1/1 · Chafing Dish Körper, GN-Einsatz 1/1
GN 1/1 chafing dish body · Corpo chafing dish GN 1/1

Ref	€	cm	h (cm)	L	U.Venta
69099	813,10	59,5x47	25,0	9,0	1

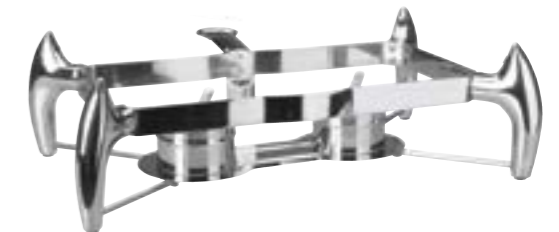

Soporte chafing dish GN 1/1 LUXE

Support Bain marie GN 1/1 · Gestell für Chafing Dish 1/1
GN 1/1 chafing dish stand · Suporte chafing dish GN 1/1

Ref	€	cm	h (cm)	U.Venta
69089	197,40	41x55	17,0	1

Placa encastrable.
Necesita agujero de Ø216 mm para introducirla
Encastable plate.
Need a Ø216 mm hole to insert the plate



Placa inducción con regulador

Plaque à induction a/regulateur · Induktionskochfeld m/ regler
Round induction plate with power control · Placa de indução com regulador

Ref	€	W	cm	U.Venta
69131	113,90	1000	Ø24x8	1



Aro complemento chafing dish

Support plaque induction · Zusatzring chafing-dish
Chafing-dish heater holder · Aro complemento chafing dish

Ref	€	Ø (cm)	U.Venta
R69099B	18,70	26	1



Salsera chafing dish

Saucière chafing-dish · Sauciere Chafing Dish
Gravy spoon holder · Molheira chafing dish

Ref	€	cm	h (cm)	L	U.Venta
R69099C	15,90	12x23	4,0	0,40	1



Chafing dish GN 2/3 LUXE

Bain marie GN 2/3 · Chafing Dish, GN-Einsatz 2/3
GN 2/3 chafing dish · Chafing dish GN 2/3

Ref	€	cm	h (cm)	L	U.Venta
69092	804,70	43x46	58,5	5,5	1



Cuerpo chafing dish GN 2/3 LUXE

Corps bain marie GN 2/3 · Chafing Dish Körper, GN-Einsatz 2/3
GN 2/3 chafing dish body · Corpo chafing dish GN 2/3

Ref	€	cm	h (cm)	L	U.Venta
69095	635,60	46x43	25,5	5,5	1



Soporte chafing dish LUXE GN 2/3

Support Bain marie GN 2/3 · Gestell für Chafing Dish 2/3
GN 2/3 chafing dish stand · Suporte chafing dish GN 2/3

Ref	€	cm	h (cm)	U.Venta
69087	169,10	40x37	17,0	1



Chafing dish GN 1/2 LUXE

Bain marie GN 1/2 · Chafing Dish, GN-Einsatz 1/2
GN 1/2 chafing dish · Chafing dish GN 1/2 steel

Ref	€	cm	h (cm)	L	U.Venta
69093	725,20	32,5x46	44,5	4,0	1



Cuerpo chafing dish LUXE GN 1/2

Corps bain marie GN 1/2 · Chafing Dish Körper, GN-Einsatz 1/2
GN 1/2 chafing dish body · Corpo chafing dish GN 1/2

Ref	€	cm	h (cm)	L	U.Venta
69094	585,60	46x32,5	25,5	4,0	1



Soporte chafing dish GN 1/2 LUXE

Support Bain marie GN 1/2 · Gestell für Chafing Dish 1/2
GN 1/2 chafing dish stand · Suporte chafing dish GN 1/2

Ref	€	cm	h (cm)	U.Venta
69088	139,50	40x28	17,0	1



Aro complemento chafing dish

Support plaque induction · Zusatzring chafing-dish
Chafing-dish heater holder · Aro complemento chafing dish

Ref	€	Ø (cm)	U.Venta
R69099B	18,70	26	1



Salsera chafing dish

Saucière chafing-dish · Sauciere Chafing Dish
Gravy spoon holder · Molheira chafing dish

Ref	€	cm	h (cm)	L	U.Venta
R69099C	15,90	12x23	4,0	0,40	1

Placa encastrable.
Necesita agujero de Ø216 mm para introducirla
Encastable plate.
Need a Ø216 mm hole to insert the plate



Placa inducción con regulador

Plaque à induction a/regulateur · Induktionskochfeld m/ regler
Round induction plate with power control · Placa de indução com regulador

Ref	€	W	cm	U.Venta
69131	113,90	1000	Ø24x8	1

Placa encastrable.
Necesita agujero de Ø216 mm para introducirla
Encastable plate.
Need a Ø216 mm hole to insert the plate



Placa inducción con regulador

Plaque à induction a/regulateur · Induktionskochfeld m/ regler
Round induction plate with power control · Placa de indução com regulador

Ref	€	W	cm	U.Venta
69139	113,20	700	Ø18x8	1



Aro complemento chafing dish

Support plaque induction · Zusatzring chafing-dish
Chafing-dish heater holder · Aro complemento chafing dish

Ref	€	Ø (cm)	U.Venta
R69094A	18,90	18	1



Salsera chafing dish

Saucière chafing-dish · Sauciere Chafing Dish
Gravy spoon holder · Molheira chafing dish

Ref	€	cm	h (cm)	L	U.Venta
R69099C	15,90	12x23	4,0	0,40	1



Chafing dish SOPA LUXE

Bain marie soupriere · Suppen Chafing Dish
Soup chafing dish · Chafing dish sopa

Ref	€	Ø (cm)	h (cm)	L	U.Venta
69098	640,90	45	57,0	11,0	1



Chafing dish REDONDO LUXE

Bain marie ronde · Chafing Dish, rund
Round chafing dish · Chafing dish redondo

Ref	€	cm	h (cm)	L	U.Venta
69101	796,40	46,5x53	45,0	6,0	1



Cuerpo chafing dish SOPA LUXE

Corps bain marie soupriere · Suppen Chafing Dish Körpe
Soup chafing dish body · Corpo chafing dish sopa

Ref	€	Ø (cm)	h (cm)	L	U.Venta
69100	471,00	45	38,0	11,0	1



Soporte chafing dish SOPA LUXE

Support bain marie soupriere · Gestell für Suppen Chafing Dish
Soup chafing dish stand · Suporte chafing dish sopa

Ref	€	cm	h (cm)	U.Venta
69097	170,00	41x32	17,0	1



Cuerpo chafing dish REDONDO LUXE

Corps bain marie ronde · Chafing Dish Körpe, rund
Round chafing dish body · Corpo chafing dish redondo

Ref	€	cm	h (cm)	L	U.Venta
69096	626,50	46,5x53	25,0	6,0	1



Soporte chafing dish SOPA LUXE

Support bain marie soupriere · Gestell für Suppen Chafing Dish
Soup chafing dish stand · Suporte chafing dish sopa

Ref	€	cm	h (cm)	U.Venta
69097	170,00	41x32	17,0	1

Placa encastrable. Necesita agujero de Ø216 mm para introducirla
Encastable plate. Need a Ø216 mm hole to insert the plate



Placa inducción con regulador

Plaque à induction a/regulateur · Induktionskochfeld m/ regler
Round induction plate with power control · Placa de indução com regulador

Ref	€	W	cm	U.Venta
69131	113,90	1000	Ø24x8	1



Salsera chafing dish

Saucière chafing-dish · Sauciere Chafing Dish
Gravy spoon holder · Molheira chafing dish

Ref	€	cm	h (cm)	L	U.Venta
R69099C	15,90	12x23	4,0	0,40	1



Aro complemento chafing dish

Support plaque induction · Zusatzring chafing-dish
Chafing-dish heater holder · Aro complemento chafing dish

Ref	€	Ø (cm)	U.Venta
R69100B	19,30	27	1



Contenedor chafing dish LUXE SOPA

Soupiere Bain marie · Suppenbehälter chafing Dish
Soup container chafing dish · Recipiente chafing dish sopa

Ref	€	Ø (cm)	h (cm)	L	U.Venta
R69100A	25,10	29	22,0	11,0	1

Placa encastrable. Necesita agujero de Ø216 mm para introducirla
Encastable plate. Need a Ø216 mm hole to insert the plate



Placa inducción con regulador

Plaque à induction a/regulateur · Induktionskochfeld m/ regler
Round induction plate with power control · Placa de indução com regulador

Ref	€	W	cm	U.Venta
69131	113,90	1000	Ø24x8	1



Salsera chafing dish

Saucière chafing-dish · Sauciere Chafing Dish
Gravy spoon holder · Molheira chafing dish

Ref	€	cm	h (cm)	L	U.Venta
R69099C	15,90	12x23	4,0	0,40	1



Aro complemento chafing dish

Support plaque induction · Zusatzring chafing-dish
Chafing-dish heater holder · Aro complemento chafing dish

Ref	€	Ø (cm)	U.Venta
R69100B	19,30	27	1



Fuente para chafing dish redondo

Plat rond pour Bain marie ronde · Einsatz für chafing-dish, rund
Food pan for round chafing-dish · Travessa para chafing dish redondo

Ref	€	Ø (cm)	U.Venta
69019	59,30	35x7	1



Chafing dish GN 1/1 roll top LATÓN

Bain marie GN 1/1 roll top · Chafing Dish, mit GN-Einsatz, Rolldeckel
Chafing dish GN 1/1 roll top · Chafing dish GN 1/1 roll top

Ref	€	cm	h (cm)	L	U.Venta
69015	754,30	53x32,5	6,50	9,0	1



Chafing dish GN 1/1 roll top INOX

Bain marie GN 1/1 roll top · Chafing Dish, mit GN-Einsatz, Rolldeckel
Chafing dish GN 1/1 roll top · Chafing dish GN 1/1 roll top

Ref	€	cm	h (cm)	L	U.Venta
69034	676,80	53x32,5	6,50	9,0	1



Chafing dish GN1/1 con tapa CLASSIC

Bain marie GN 1/1 avec couvercle · Chafing Dish, mitGN-Einsatz 1/1 mit Deckel
Chafing Dish GN 1/1 with lid · Chafing Dish GN 1/1 com tampa

Ref	€	cm	h (cm)	L	U.Venta
69110	107,10	56x35	28,0	8,5	1

Gel de origen orgánico
No produce emanaciones tóxicas
Encendido rápido y combustión silenciosa, limpia, inodora, sin humos y sin cenizas.
Organic gel fuel
Does not produce toxic fumes
Quick-lighting and quiet-burning, clean, odourless, smokeless and ash-free

Inox



Contenedor de combustible

Porte-brûleur · Brennpasten-Behälter
Burner holder · Recipiente de combustible

Ref	€	Ø (cm)	h (cm)	L (cm) Asa	U.Venta
69006	23,90	9,0	6,0	7,0	1

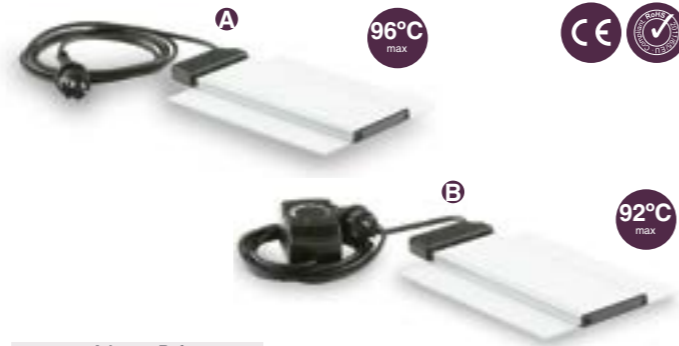

Adapt. a Ref
69015 - 69001 - 69004 - 69110

Calentador eléctrico para chafing

Corp de chauffe pour bain marie · Elektro-Heizung für Chafing Dish
Electric heating unit for chafing dish · Aquecedor eléctrico para chafing dish

Ref	€	W	U.Venta
A 69002	185,60	700	1
B 69012	214,70	700	1

Con regulador · With regulator



Gel combustible ETANOL

Gel chauffe ETHANOL · Brennpaste, ETHYALKOHOL
Fuel gel, ETHANOL · Gel combustible ETANOL

Ref	€	Kg	Horas	U.Venta
A 71780	4,80	0,08	80 min	1
B 69108	2,70	0,225	3	72
C 69107	8,60	0,840	-	1
D 69109	39,40	4,00	-	1

Set 3 latas · 3 can set
Lata · Can
Botella · Bottle
Bidón · Barrel

Combinaciones posibles de cubetas · Possible tray options

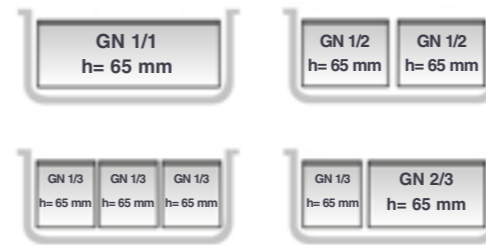

Chafing dish eléctrico

Chafing dish électrique · Elektrische Chafing Dish
Electric Chafing dish · Chafing dish eléctrico

Ref	€	W	U.Venta
69336	178,10	900	1

Ref	Tensión/Voltage	Potencia/Power	Capacidad/Capacity	Temperatura/Temp.	Cubeta/Container	Dimensiones/Sizes	Peso/Weight
69336	220-240 V / 50-60 Hz	900 W	8,50 L	85°C (+/-10°C)	1GN 1/1 h=65 mm	55x34,5x25 cm	3,90 Kg



Servidor de zumos cromado

Distributeur de jus en inox · Saftbehälter mit rostfreiem Fuss
Juice dispenser mirror stand · Distribuidor de zumos pé cromado

Ref	€	L	U.Venta
69027	331,80	8,70	1
A R69018	28,80	-	1
B R69027	94,90	8,70	1

Grifo · Tap
Contenedor · Container



Calentador de líquidos BUFFET

Chauffe-café · Getränkebehälter
Coffee urn · Aquecedor de líquidos

Ref	€	L	U.Venta
69028	372,70	11,0	1
A R69018	28,80	-	1

Grifo · Tap



- Ideal para el sector de la hostelería, restauración y catering.
- Mantiene la temperatura de los alimentos.
- Más seguro al carecer de llama de los geles.
- Tapa y cubeta extraíble GN 1/1 h=65 mm (8,50 L) fabricados en acero inoxidable de alta calidad. Cuerpo fabricado en polipropileno.
- Termostato regulable (85°C +/-10°C).
- Interruptor de encendido y apagado. Indicador luminoso.
- Protección contra sobrecalentamiento.
- Fácil de transportar gracias a sus asas laterales.
- 6 pies antideslizantes y resistentes para mantener la estabilidad.

- Parfait pour le secteur hôtelier, la restauration et le traiteur.
- Conserve la température des aliments.
- Plus sûr parce qu'il n'y a pas de flamme des gels.
- Couvercle et bac amovible GN 1/1 h=65 mm (8,50 L) en acier inoxydable de haute qualité. Corps fabriqué en polypropylène.
- Thermostat réglable (85°C +/- 10°C).
- Interrupteur marche/arrêt. Indicateur lumineux.
- Protection contre les surchauffes.
- Facile à transporter grâce à ses poignées latérales.
- 6 pieds antidérapants et résistants pour maintenir la stabilité

- Ideal for the hospitality, restaurant and catering sectors.
- Maintains temperature of food.
- Safer than chafing dishes that use gel fuels.
- Removable lid and tray GN 1/1 h=65 mm (8.5 L) manufactured in high-quality stainless steel. Body manufactured in polypropylene.
- Adjustable thermostat (85°C +/-10°C).
- On / Off switch. Light indicator.
- Overheating protection.
- Easily portable using the side handles.
- 6 non-slip resistant bases to ensure stability.

AIRPOT

Colección

Boca ancha para cubitos hielo
Wide mouth for ice cubes



Doble pared
Double wall

Air pot

Air pot · Getränkespender, isoliert
Air pot · Air pot

Ref	€	L	h (cm)	U.Venta
62472	69,60	2,50	32,5	1
62473	75,50	3,00	34,5	1
62475	101,20	4,00	39,0	1



Fácil apertura
Marcas de llenado
Sensor de temperatura
Easy open system
Fill lines
Temperature sensor

Airpot eléctrico

Électrique Airpot · Elektrische Getränkespender
Electric Airpot · Airpot eléctrico

Ref	€	L	U.Venta
69472	131,00	4	1
69476	141,60	6	1
69471	154,60	10	1

Ref	Tensión/Voltage	Potencia/Power	Capacidad/Capacity	Temperatura/Temp.	Dimensiones/Sizes	Peso/Weight
69472	220-240 V / 50-60 Hz	1500 W	4 L	60°C - 100°C	28x28x35 cm	1,90 Kg
69476	220-240 V / 50-60 Hz	1500 W	6 L	60°C - 100°C	28x28x40 cm	2,00 Kg
69471	220-240 V / 50-60 Hz	1500 W	10 L	60°C - 100°C	28x28x48 cm	2,20 Kg

Inox

NO UTILIZAR CON BEBIDAS GASEOSAS, CALDOS NI LÁCTEOS

DO NOT USE WITH FIZZY DRINKS, BROTHS OR DAIRY



- Mantiene las bebidas calientes o frías durante 24 horas.
- Doble pared que proporciona un alto rendimiento térmico.
- Ligero e irrompible.
- Boca ancha para cubos de hielo.
- Fácil de abrir y cerrar. Fácil limpieza.
- Maintient les boissons chaudes ou froides pendant 24 heures.
- Double paroi qui confère un haut rendement thermique.
- Léger et incassable.
- Bec large pour glaçons.
- Ouverture et fermeture faciles. Facile a nettoyer.
- Keeps drinks hot or cold for 24 hours.
- Double wall that provides high thermal performance.
- Light and shatterproof.
- Wide mouth for ice cubes.
- Easy to open and close. Facile a nettoyer.

Inox CE

NO UTILIZAR CON BEBIDAS GASEOSAS, CALDOS NI LÁCTEOS

DO NOT USE WITH FIZZY DRINKS, BROTHS OR DAIRY

- Dispensador con capacidades de 4, 6 y 10 litros.
- Fabricado en acero inoxidable resistente y de alta calidad.
- Dispone de un grifo dispensador con indicador de nivel de líquido.
- Temperatura controlada por termostato con un rango de 60°C a 100°C.
- Dispone de asas laterales aislantes del calor para un desplazamiento seguro.
- Ideal para agua, café y té.
- Distributeur d'une capacité de 4, 6 litres et de 10 litres.
- Fabriqué en acier inoxydable résistant et de grande qualité.
- Dispose d'un robinet de distribution avec indicateur du niveau de liquide.
- Température contrôlée par thermostat dans une tranche de 60°C à 100°C.
- Dispose de poignées latérales isolantes de la chaleur pour un déplacement sûr.
- Idéal pour l'eau, le café et le thé.
- 4, 6 and 10 litre capacity beverage dispensers.
- Made of strong high quality stainless steel.
- Includes a spigot with a level indicator.
- Temperature controlled by a thermostat with a range from 60°C to 100°C.
- Side mounted insulated handles for safe moving.
- Perfect for water, coffee and tea.

PERCOLADORA

Cafetera

Inox CE

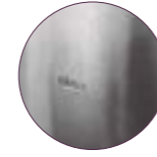

Fácil apertura
Marcas de llenado
Filtro microperforado
Easy open system
Fill lines
Micro-perforated filter



Cafetera percoladora

Percolateur à café · Kaffee-Perkolator
Coffee percolator · Máquina/Percolador de café

Ref	€	W	L	U.Venta
69486	162,90	1500	6	1
69481	181,70	1500	10	1

Ref	Tensión/Voltage	Potencia/Power	Volumen/Volume	Capacidad/Capacity	Dimensiones/Sizes	Peso/Weight
69486	220-240 V; 50 Hz	1500 W	6 L	4,8 L (max)	28x28x40 cm	2,20 Kg
69481	220-240 V; 50 Hz	1500 W	10 L	8,2 L (max)	35x35x45 cm	2,80 Kg

- Fabricada en acero inoxidable de gran calidad.
- Ideal para cafeterías, restaurantes, bares, servicios de buffet y estaciones self-service.
- 2 sistemas de calentamiento independientes para la función de infusión y la función de conservación del calor.
- Distribución de calor rápida y homogénea.
- Mantiene el café a la temperatura óptima salvaguardando sus propiedades de sabor y aroma durante horas.
- Filtro de malla microperforada de acero inoxidable, especialmente diseñado para evitar la generación de posos.
- Luz indicadora de preparación. Indicador del nivel de agua. Bandeja antigoteo.
- Tapa con cierre de seguridad mediante botón de bloqueo.
- Sistema de protección contra el calentamiento en vacío.
- Opción de flujo continuo para una máxima comodidad.
- Tapa, filtro y tubo percolador aptos para el lavavajillas.

- Made of high quality stainless steel.
- Perfect for cafés, restaurants, bars, buffet services and self-serve stations.
- Two independent heating systems for the infusion function and the heat preservation system.
- Fast and even heat distribution.
- Keeps coffee at the perfect temperature so it can retain its flavour and aroma for many hours.
- Stainless steel micro-perforated filter specially designed to prevent build-up.
- In-use indicator light. Water level indicator. Anti-drip tray.
- Lid with lock button activated safety lock.
- System to protect against heating while empty.
- Continuous flow option for maximum convenience.
- The lid, filter and percolator tube are dishwasher safe.

CAFÉ

Organizador

ASA
Acrylic
Dishwasher



Organizador de café

Organisateur de café · Kaffee Veranstalter
Coffee organizer · Organizador de café

Ref	€	cm	h (cm)	U.Venta
A 62280	10,40	11,5x11,5	20	1
B 62281	37,90	35,5x26,5	18	1
C 62283	69,10	35,5x26,5	31	1



DISPENSADORES CEREALES

Colección

ABS plastic Tapa/Lid
PS Polystyrene Container
TPR Ruleta Roulette
dishwasher safe
BPA free



Conserva la frescura y el sabor de los alimentos por más tiempo
Preserves the freshness and taste of food for longer



ES

- Ideal para diversos tipos de alimentos como cereales, copos de avena, copos de maíz, pasta, café, frutos secos, etc.
- Higiénico y con gran capacidad de almacenamiento.
- Montaje en la pared, aprovecha el espacio de tu mostrador o encimera (62541-62542).

FR

- Idéal pour différents types d'aliments tels que les céréales, les flocons d'avoine, les copeaux de maïs, les pâtes, le café, les fruits secs, etc.
- Hygiénique et offrant une grande capacité.
- Montage sur le mur, gain d'espace sur le comptoir ou le plan de travail (62541-62542).

EN

- Ideal for various types of foods such as cereals, oatmeal, cornflakes, pasta, coffee, nuts, etc.
- Hygienic and with a large storage capacity.
- Wall mounted so you can make the most of your countertop or worktop space (62541-62542).



Sistema dispensador giratorio
Rotating dispensing system

Base ancha; ofrece una mayor estabilidad
Wide base for greater stability

Dispensador de cereales

Distributeur de céréales · Cerealienspender
Cereal dispenser · Dispensador de cereais

Ref	€	cm	h (cm)	L	U.Venta
62545	24,00	16x20	40	3,50	1



Tapa hermética
Lid hermetic

Sistema dispensador giratorio
Rotating dispensing system

Base ancha; ofrece una mayor estabilidad
Wide base for greater stability

Dispensador de cereales DUAL

Distributeur de céréales · Frühstücksflocken Spender
Cereal dispenser · Dispensador de cereais

Ref	€	L	U.Venta
62596	28,90	2 x 2	1
62597	37,20	3,5 x 2	1



Tapa hermética
Lid hermetic

Anclaje en pared
Wall anchor

Sistema dispensador giratorio
Rotating dispensing system

Dispensador de cereales de pared

Distributeur de céréales mural · Wandspender für Cerealien
Wall-mounted cereal dispenser · Dispensador de cereais de parede

Ref	€	cm	h (cm)	L	U.Venta	
62541	16,40	14,5x12,5	31	1,50	1	Simple · Simple
62542	27,30	28x12,5	31	1,50 x 2	1	Doble · Double



Inox 18/10

Inox 18/10

Permite su uso tanto para calentamiento como para refrigeración
Allows its use for both heating and cooling

Grifo dispensador
Dispensing tap

Dispensador de cereales con base

Distributeur de Cereales sur Pied · Cerialenspender mit Fuss
Cereal Dispenser with Stand · Distribuidor de cereis com base

Ref	€	Ø (cm)	cm	L	U.Venta
A 69022	294,30	18,5	24x34x70	10,0	1
B 69023	582,80	18,5	44x34x70	10,0	1

Dispensador de leche

Dispensateur de lait · Milchkanne mit Fuß
Milk dispenser with base · Distribuidor de leite

Ref	€	cm	L	U.Venta
69030	412,30	22x33x44	5,5	1

BUFFET

Cacerolas



ES

- Fabricada en acero inoxidable 18/10 de la mejor calidad.
- Acabado interior lijado satinado y exterior en color rojo/blanco ocean.
- Marcaje de capacidades en el interior (Litros).
- Tapa de vidrio templado con salida de vapor y aro protector de acero inoxidable.
- Tapa diseñada para colocar en el borde de la cacerola.
- Asas ergonómicas fabricadas en acero inoxidable de fundición.
- Fondo termodifusor sandwich (Inox 18/10 - Aluminio - Inoxidable).
- Apts para todos los fuegos (incluido inducción y horno).

FR

- Fabriqué en acier inoxydable 18/10 de la meilleure qualité.
- Finition intérieure en polissage satiné et l'extérieur rouge/blanc/ocean.
- Marquage des contenances à l'intérieur (litres).
- Couvercle en verre trempé avec sortie de vapeur et anneau de protection en acier inoxydable.
- Couvercle conçu pour être placé sur le bord de la casserole.
- Poignées ergonomiques en acier inoxydable fondu.
- Fond thermodiffuseur sandwich (inox 18/10 - aluminium - inoxydable).
- Aptes pour tous les types de feux (y compris l'induction et le four).

EN

- Made of the highest quality 18/10 stainless steel.
- Glossy sanded interior finish and exterior in red/white/ocean colour.
- Capacity markings on the inside (litres).
- Tempered glass lid with steam outlet and stainless steel protective ring.
- Lid designed to fit on the rim of the pan.
- Ergonomic handles made of cast stainless steel.
- Heat-diffusing sandwiched base (18/10 stainless steel - aluminium - st. Steel).
- Suitable for all types of cookers (including induction hobs and ovens).

New



Cacerola con tapa RED

Faitout avec couvercle · Bratentopf mit Deckel
Casserole with lid · Caçarola com tampa

Ref	€	Ø (cm)	h (cm)	L	U.Venta
15316	39,80	16	8,0	1,50	1
15320	47,50	20	10,0	3,00	1
15324	57,50	24	12,0	5,00	1



Cacerola con tapa WHITE

Faitout avec couvercle · Bratentopf mit Deckel
Casserole with lid · Caçarola com tampa

Ref	€	Ø (cm)	h (cm)	L	U.Venta
15416	39,80	16	8,0	1,50	1
15420	47,50	20	10,0	3,00	1
15424	57,60	24	12,0	5,00	1

Diseñada para colocar en el borde de la cacerola
designed to fit on the rim of the pan



Cacerola con tapa OCEAN

Faitout avec couvercle · Bratentopf mit Deckel
Casserole with lid · Caçarola com tampa

Ref	€	Ø (cm)	h (cm)	L	U.Venta
15516	39,80	16	8,0	1,50	1
15520	47,60	20	10,0	3,00	1
15524	57,50	24	12,0	5,00	1

Tapa

Couvercle · Deckel
Lid · Tampa

Ref	€	Ø (cm)	U.Venta
15306	9,30	16	1
15302	10,10	20	1
15304	10,80	24	1



DEGUSTARE

Vajilla catering



ES

- Vajilla para catering moderna, innovadora y atractiva.
- Ideal para cualquier tipo de celebración como banquetes, bodas, fiestas, etc. Realizan cualquier tipo de catering de alta gama.
- Permite múltiples combinaciones gracias a la variedad de formas.
- Reutilizables e irrompibles. Manejables y ligeros para su transporte.
- 100% apilables.

FR

- Vaisselle pour buffets moderne, innovante et attractive.
- Idéale pour tout type de célébration comme des banquets, mariages, fêtes, etc. Elle sublime tout type de buffet haut de gamme.
- Permet de multiples combinaisons grâce à la variété des formes.
- Pièces réutilisables et incassables. Maniables et légères pour le transport.
- 100% empilable.

EN

- Modern, innovative and attractive catering dinnerware.
- Ideal for any type of celebration, such as banquets, weddings, parties etc. Enhances any kind of high-end catering.
- Perfect for multiple combinations due to the variety of different shapes.
- Reusable and unbreakable.
- Handy and lightweight for transport.
- 100% stackable.



6 pcs

Vajilla catering

Vaisselle pour la restauration · Catering-Geschirr
Catering dinnerware · Serviço de catering

	Ref	€	cm	h (cm)	ml	U.Venta	
A	60750	11,30	42x28,5	2,5	-	1	Bandeja · Tray
B	60751	7,60	Ø8,5	5,5	115	1	Bol flor · Flower bowl
C	60752	7,80	8,5x8,5	5,5	80	1	Bol cuadrado · Square bowl
D	60753	7,90	Ø8,0	4,0	100	1	Bol rizado · Round bowl
E	60754	7,80	13x6,5	3,5	35	1	Cuchara · Spoon
F	60755	7,30	Ø6,0	7,5	65	1	Vaso · Glass

New

BUFFET & DISPLAY

Melamina mármol



New

ES

- Fabricados en melamina de alta calidad.
- Aspecto elegante efecto mármol.
- Diseñados para presentar todo tipo de alimentos tanto fríos como calientes (70°C / -20°C).
- Ideales para exponer en todo tipo de buffet, caterings, etc.
- 100% apilables.
- Prácticos y atractivos. Presentan una funcionalidad y durabilidad inmejorables.
- Fácil limpieza: aptas para el lavavajillas.
- Libres de BPA.

FR

- Fabriqué en mélamine de haute qualité.
- Élégant aspect marbré.
- Conçu pour présenter tous types d'aliments, aussi bien chauds que froids (70°C / -20°C).
- Idéal pour la présentation dans tous les types de buffets, traiteurs, etc.
- 100 % empilables.
- Pratiques et attrayants. Fonctionnalité et durabilité imbattables.
- Facile à nettoyer : apte au lave-vaisselle.
- Sans BPA.

EN

- Made of high quality melamine.
- Elegant marble appearance.
- Designed for presenting all kinds of food, both cold and hot (70°C / -20°C).
- Perfect for displaying in all kinds of buffets, catering, etc.
- 100% stackable.
- Practical and attractive. Unbeatable functionality and durability.
- Easy to Clean: dishwasher safe.
- BPA free.

Infinidad de combinaciones posibles · Endless possible combinations

BAJOS · LOW



ALTOS · HIGH



* Compatibles con las campanas PS (Ref.: 61801-61803)



Frutero
Corbeille à fruits · Obstschüssel
Fruit basket · Fruteiro

Ref	€	Ø (cm)	h (cm)	L	U.Venta
63252	28,90	23,0	7,5	2,40	1
63253	48,80	30,5	10,0	3,80	1



Portatartas
Porte-gâteau · Tortenständer
Cake stand · Soporte de bolos

Ref	€	Ø (cm)	h (cm)	U.Venta
63250	22,40	22,5	2,0	1
63251	36,20	33,0	2,0	1

Soporte
Support · Stand
Stand · Soporte

Ref	€	Ø (cm)	h (cm)	L	U.Venta
63254	9,20	11,5	9,0	0,44	1
63255	10,90	11,5	12,0	0,71	1



Multifunción.
Soporte + vaso para servir aperitivos
Multi-purpose.
Stand + glass for serving aperitifs

Compatible con nuestros portatartas
Can be used with our cake stand



Campana cubreplatos PS
Cloche couvre plat · Tellerglocke
Plate Cover · Campânula cobre-pratos

Ref	€	Ø (cm)	h (cm)	Total (cm)	U.Venta
61801	6,50	22,0	9,0	12,0	1
61803	12,10	30,0	13,5	15,5	1



Campana cubreplatos
Cloche couvre plat · Tellerglocke
Plate Cover · Campânula cobre-pratos

Ref	€	Ø (cm)	h (cm)	Total (cm)	U.Venta
61806	39,40	25	14,0	18,5	1
61809	45,10	29	15,0	20,3	1
61802	48,80	33	17,0	22,3	1

- Cubreplatos en forma de campana semiesférica con pomo.
- Fabricada en PS de alta calidad, libre de BPA.
- Diseñada para exponer todo tipo de alimentos.
- Protege los alimentos de los factores externos, garantizando así la higiene.
- Mantiene los alimentos en perfecto estado de conservación.

- Couvre-assiette en forme de cloche hémisphérique avec bouton.
- Fabriqué en PS de haute qualité, sans BPA.
- Conçue pour présenter tous les types d'aliments.
- Protège les aliments des facteurs extérieurs, garantissant ainsi l'hygiène.
- Maintient les aliments en parfait état de conservation.

- Semi-spherical domed cloche with a knob
- Made of high quality BPA free PS
- Designed for displaying all kinds of food
- Protects food from external factors to guarantee hygiene
- Keeps food in a perfect state of conservation

- Fabricada en vidrio borosilicato de gran calidad y resistente a golpes, altas y bajas temperaturas.
- Protege los alimentos de los factores externos.
- Ideal tanto para conservar como para presentar galletas, bollería, quesos y todo tipo de alimentos.
- Se puede introducir en el microondas, horno y congelador.

- Fabriquée en verre borosilicate de grande qualité et résistante aux chocs ainsi qu'aux basses et hautes températures.
- Protège les aliments des agents externes.
- Idéale aussi bien pour conserver que pour présenter des gâteaux, des viennoiseries, des fromages et tout type d'aliments.
- Peut être mise au micro-ondes, au four ou au congélateur.

- Made of high quality impact resistant borosilicate glass that can withstand high and low temperatures.
- Protects food from external factors.
- Perfect for preserving and presenting biscuits, pastries, cheese or any other kind of food.
- Microwave, oven and freezer safe.

BUFFET PIZARRA

Bandejas · Soportes



New

Dos asas de acero inoxidable
Two stainless steel handles



Base antideslizante
Non-slip base

Bandeja pizarra con asas

plateau en ardoise avec poignées · Schiefertablett mit Griffen
Slate tray with handles · Bandeja de ardósia com asas

Ref	€	cm	h (cm)	U.Venta
61230	11,20	40x20	5,0	1
61231	16,20	45,5x30	5,0	1
61232	18,20	53x5x33	5,0	1

- Fabricada en pizarra 100% natural con amplia superficie de apoyo.
- Cuenta con 2 asas laterales de acero inoxidable de gran calidad para transportar con facilidad.
- Diseñada para presentar y servir tapas, aperitivos, postres, etc. de manera moderna y elegante.
- Excelente conductor del frío y del calor, ideal para mantener los aperitivos a la hora de servir.
- Máxima estabilidad: almohadillas antideslizantes en la base.
- Fácil limpieza. Lávala a mano, no es apta para lavavajillas.

- Fabriqué en ardoise 100% naturelle avec une grande surface d'accueil.
- Dispose de 2 poignées latérales en acier inoxydable de grande qualité pour un transport aisé.
- Conçu pour présenter et servir des tapas, apéritifs, desserts, etc. de façon moderne et élégante.
- Excellent conducteur de froid et de chaleur, idéal pour maintenir la température des apéritifs lors du service.
- Stabilité maximale : coussinets antidérapants à la base.
- Nettoyage facile. Le laver à la main, ne doit pas être mis au lave-vaisselle.

- Made of 100% natural slate with a large support surface.
- It has two high quality stainless steel side handles so it's easy to carry.
- It's designed for presenting and serving tapas or appetisers, desserts etc. in a modern and elegant way.
- It's an excellent conductor of hot and cold so it's perfect for keeping appetisers when serving them.
- Maximum Stability: non-slip pads on the base.
- Easy to clean. Wash by hand, not dishwasher safe.

New



Plato giratorio pizarra natural

Plateau tournant en ardoise naturelle · Drehteller aus Naturschiefer
Rotating serving dish in natural slate · Prato giratório em ardósia natural

Ref	€	Ø (cm)	h (cm)	U.Venta
61235	19,90	35	2,5	1

- Fabricada en pizarra 100% natural con amplia superficie de apoyo de Ø35 cm.
- Soporte giratorio de cristal y pie de acero inoxidable, permite una rotación fácil y suave en ambos sentidos.
- Diseñado para presentar y servir tapas, aperitivos, postres, etc.
- Fácil limpieza. No es apta para lavavajillas.

- Fabriqué 100% en ardoise naturelle avec une large surface de support de Ø35 cm.
- Support tournant en verre et pied en acier inoxydable ; permet une rotation facile et douce dans les deux sens.
- Conçu pour présenter et servir des tapas, apéritifs, desserts, etc.
- Nettoyage facile. Ne peut pas aller au lave-vaisselle.

- Made of 100% natural slate and featuring a large Ø 35 cm support surface.
- Revolving glass dish and stainless steel base for easy, smooth rotation in both directions.
- Designed to present and serve snacks, dips, appetisers, desserts, etc.
- Easy to clean. Not dishwasher safe.

New



Soporte expositor

Présentoir · Schieferständer
Display stand · Expositor

	Ref	€	Grande cm	Pequeña cm	h (cm)	U.Venta
A	61233	20,50	35x25	35x15	22	1
B	61234	7,80	20	15	34	1

- Soporte de dos alturas para servir y presentar aperitivos dulces o salados de una forma atractiva y original.
- Compuesto por una estructura fabricada en bambú natural y dos bandejas extraíbles fabricadas en 100% pizarra natural.
- Totalmente desmontable, facilita su limpieza y almacenamiento.
- Fuerte y resistente.
- Medidas pizarra grande: 35x25 cm / Medidas pizarra pequeña: 35x15 cm / Distancia entre pizarras: 12,5 cm.

- Support à deux hauteurs pour servir et présenter des apéritifs sucrés ou salés de façon attractive et originale.
- Composé d'une structure fabriquée en bambou naturel et de deux plateaux extractibles fabriqués 100% en ardoise naturelle.
- Entièrement démontable, ce qui facilite son nettoyage et son rangement.
- Robuste et résistant.
- Dimensions grande ardoise : 35x25 cm / Dimensions petite ardoise : 35x15 cm / Distance entre les ardoises : 12,5 cm.

- Two-tier display stand for serving and presenting sweet or savoury snacks in an attractive, original way.
- Natural bamboo structure with two removable trays made of 100% natural slate.
- Fully collapsible for easy cleaning and storage.
- Strong and resistant.
- Large size slate: 35x25 cm / Small size slate: 35x15 cm / Distance between slates: 12.5 cm.

- Soporte de dos pizarras redondas diseñadas para servir y presentar aperitivos dulces o salados de una forma atractiva y original.
- Estructura metálica interior. Incluye asa para transportar.
- Totalmente desmontable, facilita su limpieza y almacenamiento.
- Medidas pizarra grande: Ø20 cm
- Medidas pizarra pequeña: Ø15 cm
- Distancia entre pizarras: 10 cm

- Support composé de deux ardoises rondes conçues pour servir et présenter des apéritifs sucrés ou salés de façon attractive et originale.
- Structure métallique intérieure. Inclut une poignée pour le déplacer.
- Entièrement démontable, ce qui facilite son nettoyage et son rangement.
- Dimensions grande ardoise : Ø20 cm
- Dimensions petite ardoise : Ø15 cm
- Distance entre les ardoises : 10 cm

- Two-tier round slate display stand designed to serve and present sweet or savoury snacks in an attractive, original way.
- Inner metal structure. Includes handle for easy carrying.
- Fully collapsible for easy cleaning and storage.
- Large size slate: Ø20 cm
- Small size slate: Ø15 cm
- Distance between slates: 10 cm

CUBERTEROS

Colección



Inox

Soporte cubiertos con vasos

Porte couverts avec paniers · Besteckbehälter
Cutlery holder w/cylinder · Sup. talheres com copos

Ref.	€	cm	Orif.	U.Venta
33124	84,70	29x22x26	4	1
33126	104,10	29x22x38	6	1

Vasos inox cubertería

Panier pour porte couvert · Besteckköcher
St. steel cutlery cylinder · Copos p/talheres inóx

Ref.	€	h (cm)	U.Venta
33125	7,60	14	6

Contenedor cubiertos

Panier à couverts · Besteckköcher
Cutlery holder · Copos para talheres

Ref.	€	Ø (cm)	h (cm)	L	U.Venta
62962	21,00	12	13,6	1,40	1
62963	24,40	12	18,7	2,00	1

4 compartimentos

4 compartments
Hueco · Hollow: 11x25x9 cm



- Recipiente para cubiertos en color negro de polipropileno.
- Ideal para organizar y guardar los cubiertos e utensilios de la cocina.
- No se deforma con el peso de los cubiertos.
- Cómodo de transportar gracias a sus asas laterales.
- Fondo redondeado para un fácil mantenimiento.
- Apilable.

- Pot à couverts en polypropylène noir.
- Idéal pour organiser et ranger les couverts et les ustensiles de cuisine.
- Il ne se déforme pas avec le poids des couverts.
- Confortable à transporter grâce à ses poignées latérales.
- Fond arrondi pour un entretien facile.
- Empilable.

- Black polypropylene cutlery container.
- Ideal for organizing and storing cutlery and kitchen utensils.
- It does not deform with the weight of the cutlery.
- Comfortable to transport thanks to its side handles.
- Rounded bottom for easy maintenance.
- Stackable.

Cubertero GN 1/1

Range-couverts · Besteckkasten
Cutlery holder · Bandeja pata talheres

Ref	€	cm	h (cm)	U.Venta
33121	11,20	52,5x32	9,5	1



Trenzados
Braided



4 compartimentos
4 compartments

Bastidor cromado reforzado
Reinforced chrome frame

Cubertero RATTAN PP

Range-couverts · Besteckkasten
Cutlery holder · Bandeja pata talheres

Ref	€	cm	h (cm)	Compart.	U.Venta
A 63484	8,40	27x10	4,5	1	1
B 63485	8,40	Ø12	15,0	1	1
C 63491	74,80	53x32,5	9,0	4	1

PANERAS · FRUTEROS

Colección



- Cuerpo fabricado en acero al carbono lacado en blanco.
- Tapa fabricada en madera de caucho con orificios de ventilación para una óptima circulación del aire.
- Diseño vintage. Forma rectangular con esquinas redondeadas.
- Diseñado para conservar el pan y otros productos siempre frescos.
- 2 en 1: la tapa de madera de caucho se puede utilizar como tabla de cortar.
- Almacenamiento compacto.

- The body is made of carbon steel with white lacquer.
- The lid is made of rubberwood with ventilation holes for optimum air circulation.
- It has a vintage design. It is rectangular with rounded corners.
- It is designed to keep bread and other products always fresh.
- 2 in 1: The rubberwood lid can be used as a cutting board.
- Compact storage.



Madera caucho
Rubber wood

Fe
Hierro
Iron

Panera NÓRDICA

Boîte à pain · Brotkasten
Bread basket · Caixa para guardar pão

Ref	€	cm	h (cm)	U.Venta
A 62868	38,60	30x18	12,5	1
B 62869	41,90	42x22,5	12,5	1



Puerta abatible. Capacidad para todo tipo de panes
Mantiene el pan protegido, prolonga su conservación
Folding door. Capacity for all kinds of breads
Keeps the bread protected and prolong its conservation

Inox



Panera abatible

Paniere rabattable · Abfallen Brotkorb
Bread bin foldable lid · Cestonreclinável

Ref	€	cm	h (cm)	U.Venta
62944	41,90	44x29	19	1

Inox



Frutero - Panera INOX

Paniere à fruit et à pain · Brot-/Obstschale
Fruits and bread basket · Fruteiro-Cesto

Ref	€	Ø (cm)	U.Venta
61821	7,50	20	1
61823	11,30	24	1



Panera KRAFT

Boîte à pain · Brotkasten
Bread basket · Caixa para guardar pão

	Ref	€	cm	h max (cm)	h min (cm)	U.Venta
A	63476	13,40	10x10	25	8	1
B	63477	14,30	12x12	25	12	1
C	63478	16,20	15x15	25	12	1
D	63479	18,70	20x20	33	12	1



Panera TEX

Boîte à pain · Brotkasten
Bread basket · Caixa para guardar pão

	Ref	€	cm	h max (cm)	h min (cm)	U.Venta
A	63486	13,40	10x10	25	8	1
B	63487	14,30	12x12	25	12	1
C	63488	16,20	15x15	25	12	1
D	63489	18,70	20x20	33	12	1

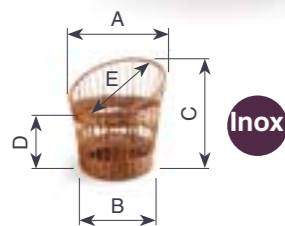

Inox
Estructura de refuerzo de acero inoxidable
Stainless steel reinforcement structure

Cesta baguette

Corbeille · Brotkorb
Basket · Cesta

	Ref	€	ØA (cm)	ØB (cm)	C (cm)	D (cm)	E (cm)	U.Venta
A	63492	62,70	32,0	28,5	42,0	25,0	36,5	1
B	63493	62,70	32,0	28,5	42,0	25,0	36,5	1



- Fabricadas en fibra virgen natural.
- Material ecológico y respetuoso con el medio ambiente.
- Lavables, resistentes y duraderas.
- Diseñadas y fabricadas en España.
- Hechas a mano.
- Tacto agradable y suave, similar a la piel.
- Espesor 0,55 mm.

- Fabriquées en fibres vierges naturelles.
- Matériau écologique et respectueux de l'environnement.
- Lavables, résistantes et durables.
- Conçues et fabriquées en Espagne.
- Faites à la main.
- Toucher agréable et doux, similaire au cuir.
- Épaisseur de 0,55 mm.

- Made of natural virgin fibre.
- Ecological material respectful with the environment.
- Washable, resistant and durable.
- Designed and manufactured in Spain.
- Handmade.
- Nice soft feel, similar to leather.
- Thickness 0.55 mm.



- Cestas para pan fabricadas en polipropileno.
- Diseñadas para uso intensivo.
- Estructura de refuerzo de acero inoxidable. Parte trasera más alta que proporciona suficiente apoyo para panes largos (63492-63493).
- Material con aspecto de mimbre muy resistente, libre de BPA.
- Elaboradas a mano.
- Prácticas e higiénicas. Acabado en mate.
- Ideales para almacenar y exponer panes.
- Apilables.
- Fácil limpieza.

- Paniers pour pain fabriqués en polypropylène.
- Conçu pour une utilisation intensive.
- Structure renforcée en acier inoxydable. Partie arrière plus haute afin d'offrir un meilleur support aux pains longs (63792-63493).
- Matériau très résistant à l'aspect de rotin, sans BPA.
- Fait à la main.
- Pratiques et hygiéniques. Fini mat.
- Parfaits pour ranger et exposer des pains.
- Empilables.
- Faciles à nettoyer.

- These bread baskets are made of polypropylene.
- Designed for intensive use.
- Stainless steel reinforcement structure. The taller back gives plenty support for long loaves of bread (63792-63493).
- The very strong material looks like wicker and it's BPA free.
- Handmade.
- They're practical and hygienic. Matte finish.
- Perfect for storing or displaying bread.
- Stackable.
- Easy to clean.



Cesta de pan redonda

Corbeille a pain ronde · Brotkorb, rund
Round bread basket · Cesta de pão redonda

	Ref	€	Ø (cm)	h (cm)	U.Venta
	63471	7,70	19	8	1
A	63472	8,60	21	8	1
	63473	9,20	23	8	1
	63474	9,80	28	8	1
	63871	7,80	19	8	1
B	63872	8,60	21	8	1
	63873	9,20	23	8	1
	63874	9,90	28	8	1



Cesta de pan oval

Corbeille a pain ovale · Brotkorb, Oval
Oval bread basket · Cesta de pão oval

	Ref	€	cm	h (cm)	U.Venta
	63480	7,00	19x14	8,0	1
A	63481	8,30	24x17	8,0	1
	63482	10,10	28x16	8,5	1
	63880	7,00	19x14	8,0	1
B	63881	8,20	24x17	8,0	1
	63882	10,10	28x16	8,5	1



Cesta de pan

Corbeille a pain · Brotkorb
Bread basket · Cesta de pão

	Ref	€	Ø (cm)	h (cm)	U.Venta
A	63494	30,00	35	20	1
B	63894	29,50	35	20	1



Cesta de pan cuadrada

Corbeille a pain carré · Brotkorb, viereckig
Square bread basket · Cesta de pão quadrada

	Ref	€	cm	h (cm)	U.Venta
A	63490	34,30	53x33,5	9	1
B	63890	34,00	53x33,5	9	1

New

Medidas · Sizes
19,5x17,5x7 cm



Medidas · Sizes
29x18x8 cm

Frutero DUAL SQ
Corbeille à fruits · Obstkorb
Fruit basket · Fruteira

Ref	€	cm	h (cm)	U.Venta
61124	18,80	29x18,5	33,5	4

Fe Hierro Iron
Madera caucho Rubber wood

- Frutero de doble altura fabricado en metal y acabado negro mate.
- Asa fabricada en madera de caucho.
- Diseño transpirable: permite que el aire circule mejor, manteniendo así las frutas y verduras siempre frescas.
- 100% estable y resistente.
- Desmontable: las cestas se pueden utilizar por separado.
- Versátil: ideal para fruta, verdura, tarros de conservas, etc.

- Corbeille à fruits à double hauteur fabriquée en métal et finition noir mat.
- Poignée fabriquée en bois de caoutchouc.
- Conception aérée : permet à l'air de mieux circuler, maintenant ainsi les fruits et les légumes toujours frais.
- 100% stable et résistante.
- Démontable : les paniers peuvent être utilisés séparément.
- Polyvalente : idéale pour les fruits, les légumes, pots de conserve, etc.
- Two tier fruit basket made of metal with a matte black.
- Handle made of rubber wood.
- The breathable design lets air circulate better to keep your fruit and vegetables fresh all the time.
- 100% stable and resistant.
- Detachable: the baskets can be used separately.
- Versatile: perfect for fruit, vegetables, canning jars, etc.

Madera contrachapada color haya
Plywood beech color

Fe Hierro Iron



Frutero varillas

Corbeille à fruits · Obstschale aus Gitterstäben
Square fruit bowl · Cesto de metal para fruta

Ref	€	Cesta (cm)	h Total (cm)	ØVarilla (mm)	U.Venta
A 61137	34,40	26x26x18,3	27,8	4	1
B 61138	34,40	Ø25,2x17,7	28,9	4	1

Madera aglomerada
Agglomerate wood

Fe Hierro Iron



Frutero varillas redondo bajo

Corbeille à fruits ronde basse · Obstschale aus Gitterstäben
Round low rod fruit bowl · Cesto de metal para fruta redondo baixo

Ref	€	Cesta (cm)	h (cm)	Ø Base (mm)	ØVarilla (mm)	U.Venta
61139	39,70	Ø39x6	7,6	31,3	4	1



Ideales para almacenar fruta, pan, verduras, huevos, etc.
Can be used for storing fruit, bread, vegetables, eggs, etc.

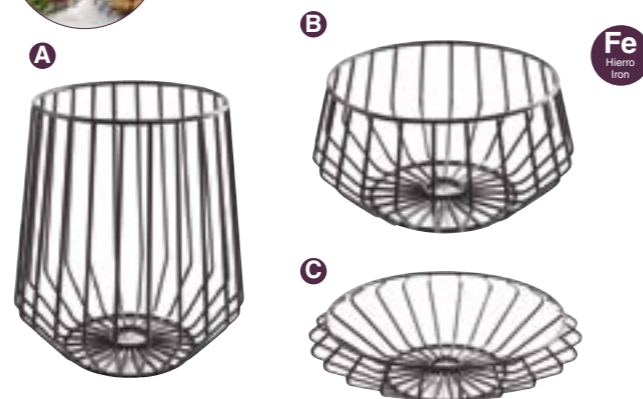

Frutero varillas

Corbeille à fruits · Obstschale aus Gitterstäben
Rod fruit bowl · Cesto de metal para fruta

Ref	€	Ø (cm)	h (cm)	ØVarilla (mm)	U.Venta
A 61126	22,90	23,4	25,4	4	2
B 61127	20,80	27,0	13,8	4	1
C 61128	22,00	34,0	9,5	4	1

Frutero varillas DUAL

Corbeille à fruits · Obstschale aus Gitterstäben
Rod fruit bowl · Cesto de metal para fruta

Ref	€	Grande (cm)	Peq. (cm)	h (cm)	ØVarilla (mm)	U.Venta
61140	53,40	Ø40x10	Ø24x10	63	4	1

TOSTADORAS BUFFET

Colección

Inox 18/10 CE RoHS



Tostado continuo de pan
Doble sistema de calentamiento
Cinta transportadora
Bandeja de recogida de migas
Continuous bread toasting
Dual heating system
Conveyor belt
Crumb collection tray

Tostador CONTINUE

Grille-painl · Toaster
Toaster · Torradeira

Ref	€	W	U.Venta
69065	835,90	1340	1
69066	964,10	2240	1

Calentamiento infrarrojos
Lámparas infrarrojas halógenas de cuarzo
Hueco útil entre parrillas 5,5 cm
Bandeja recogemigas
Infrared heating Quartz halogen infrared lamps
Usable gap between racks 5.5 cm
Crumbs tray

Tostador HORIZONTAL

Grille-painl · Toaster
Toaster · Torradeira

Ref	€	W	U.Venta
A 69172	354,30	2400	1
B 69173	418,80	3150	1

Ranuras de grandes dimensiones
Bandeja recogemigas
Huge slots for toasting
Crumbs tray

Tostador BUFFET

Grille-painl · Toaster
Toaster · Torradeira

Ref	€	Ranuras	U.Venta
A 69294	230,70	4	1
B 69296	306,40	6	1

Características · Characteristics:

Referencia · Reference: 69065
Tensión · Voltage: 220-240 V; 50Hz
Potencia · Power: 1340 W
Velocidad · Speed: 0,46 - 0,73 m/min
Producción · Production: 150 h
Dimensiones · Sizes: 53x37x40 cm
Peso · Weight: 12,85 kg

Características · Characteristics:

Referencia · Reference: 69066
Tensión · Voltage: 220-240 V; 50Hz
Potencia · Power: 2240 W
Velocidad · Speed: 0,46 - 0,73 m/min
Producción · Production: 300 h
Dimensiones · Sizes: 53x45x40 cm
Peso · Weight: 15,50 kg

Características · Characteristics:

Referencia · Reference: 69172
Tensión · Voltage: 220-240 V; 50-60 Hz
Potencia · Power: 2400 W
Lámparas · Lamps: 6 (3+3)
Parrilla · Grill: 40x24 cm
Dimensiones · Sizes: 50x25x28 cm
Peso · Weight: 7,10 kg

Características · Characteristics:

Referencia · Reference: 69173
Tensión · Voltage: 220-240 V; 50-60 Hz
Potencia · Power: 3150 W
Lámparas · Lamps: 9 (3+3+3)
Parrilla · Grill: 40x24 cm
Dimensiones · Sizes: 50x25x38 cm
Peso · Weight: 9,20 kg

Características · Characteristics:

Referencia · Reference: 69264
Tensión · Voltage: 220-240 V; 50-60 Hz
Potencia · Power: 1800 W
Selector · Selector: 2/4 ranuras · groves
Ranura · Slot: 15x3 cm
Dimensiones · Sizes: 29x26x22 cm
Peso · Weight: 3,90 kg

Características · Characteristics:

Referencia · Reference: 69266
Tensión · Voltage: 220-240 V; 50-60 Hz
Potencia · Power: 2500 W
Selector · Selector: 2/4/6 ranuras · groves
Ranura · Slot: 15x3 cm
Dimensiones · Sizes: 42x26x22 cm
Peso · Weight: 5,00 kg



Doble ranura extralarga diseñada para tostar todo tipo de panes
Extra-long double slot toaster designed to toast all types of bread

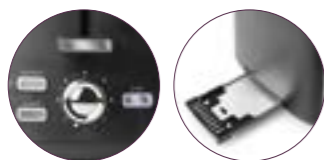

Tostadora LONG

Grille-pain · Toaster
Toaster · Torradeira

Ref	€	W	U.Venta
69260	57,60	1500	1

Inox New design

- Tostadora de doble ranura extralarga diseñada para tostar todo tipo de panes.
- Fabricada en acero inoxidable de gran calidad.
- Práctica, segura y muy fácil de usar.
- Función de descongelación (Defrost), calentamiento (Reheat) y cancelación (Stop).
- Bandeja recogemigas para facilitar la limpieza.
- Dispone de 7 niveles de tostado. Medidas de la ranura: 25 x 4 cm.

- Grille-pain à double rainure extra-large conçu pour griller tout type de pains.
- Fabriqué en acier inoxydable de grande qualité.
- Pratique, sûr et très facile à utiliser.
- Fonction de décongélation (Defrost), réchauffage (Reheat) et annulation (Stop).
- Plateau ramasse-miettes pour faciliter le nettoyage.
- Dispose de 7 niveaux de brunissage. Dimensions de la rainure : 25 x 4 cm.

- Extra-long double slot toaster designed to toast all types of bread.
- Made of high quality stainless steel.
- Practical, safe and easy to use.
- DEFROST, REHEAT and CANCEL functions.
- Removable crumb tray for easy cleaning.
- 7 browning levels. Slot dimensions: 25 x 4 cm

Características · Characteristics:

Referencia · Reference: 69260
Tensión · Voltage: 220-240 V; 50-60 Hz
Potencia · Power: 1400 W
Dimensiones · Sizes: 38x18x20 cm
Peso · Weight: 1,70 kg



Tostadora horizontal

Toaster horizontal · Horizontal-/Toaster
Electric toaster · Torradeira horizontal

	Ref	€	W	U.Venta
A	69163	33,00	600	1 BASIC
B	69363	41,30	600	1 EASY



Ranura extralarga diseñada para tostar todo tipo de panes
Extra-long slot toaster designed to toast all types of bread



Tostadora DUPLO

Grille-pain · Toaster
Toaster · Torradeira

Ref	€	W	U.Venta
69360	63,70	1000	1

- Fabricada en acero inoxidable 18/10 de gran calidad y resistencia
- Permite tostar de forma rápida y sencilla, sin necesidad de añadir grasa alguna
- Función de descongelación y cancelación
- Regulador ajustable de tueste, elige entre 7 niveles para tostar a tu gusto
- Ranura alargada de 25 cm de largo para rebanadas extra largas o para más de una rebanada de pan
- Incorpora una práctica bandeja, donde se depositan las migas

- Fabriqué en acier inoxydable 18/10 d'une grande qualité et résistance
- Permet de griller de façon rapide et simple sans nécessité d'ajouter aucune graisse
- Fonction de décongélation et d'arrêt
- Régulateur de brunissage réglable : choisissez parmi 7 niveaux pour griller selon vos souhaits
- Rainure allongée de 25 cm de longueur pour des tranches extra larges ou pour plus d'une tranche de pain
- Intègre un plateau pratique sur lequel se déposent les miettes

- Made of strong high quality 18/10 stainless steel
- Fast and easy toasting without the need to use any fatty products
- Defrost and cancel functions
- Adjustable darkness regulator. Choose from 7 levels for toasting as you like.
- Long 25 cm slot for extra wide slices of bread or more than one slice of bread at once
- It has a practical tray for catching crumbs

Características · Characteristics:

Referencia · Reference: 69360
Tensión · Voltage: 220-240 V; 50-60 Hz
Potencia · Power: 1000 W
Dimensiones · Sizes: 41x12x18,5 cm
Peso · Weight: 1,40 kg

CHOCOLATE Fuentes



Fuente de chocolate

Fontaine chocolat · Schokoladen Fontäne
Chocolate fountain · Fonte chocolate

	Ref	€	Tower	U.Venta
A	69318	60,10	18 cm	1
B	69319	102,20	38 cm	1

- Gracias a su diseño y área de calentamiento podrá tostar todo tipo de panes o bollería y varias rebanadas a la vez.
- Grâce à sa conception et sa zone de chauffe, vous pourrez griller tout type de pains ou de viennoiseries et plusieurs tranches à la fois.
- Dank des Designs und des Erwärmungsbereichs können Sie alle möglichen Brotsorten und mehrere Scheiben gleichzeitig tosten.
- Thanks to its design and heating area you will be able to toast all types of bread and pastries, and several slices at a time.
- Graças ao seu desenho e área de aquecimento, poderá tostar todo o tipo de pães ou bolos, e várias fatias ao mesmo tempo.

Características · Characteristics:

Referencia · Reference: 69163
Tensión · Voltage: 220-240 V; 50-60 Hz
Potencia · Power: 600 W
Temperatura · Temperature: 360°C
Tostado · Toasted: 6
Parrilla · Grill: 25x20 cm
Dimensiones · Sizes: 36x21x6,5 cm
Peso · Weight: 1,00 kg

Características · Characteristics:

Referencia · Reference: 69363
Tensión · Voltage: 220-240 V; 50-60 Hz
Potencia · Power: 600 W
Temperatura · Temperature: 360°C
Tostado · Toasted: 6
Parrilla · Grill: 25x20 cm
Dimensiones · Sizes: 42x30x9 cm
Peso · Weight: 1,00 kg



- Fabricada en acero inoxidable 18/10 de gran calidad.
- Crea una cascada de chocolate fundido y lo mantiene caliente para bañar alimentos.
- Ideal para buffet, hoteles, restaurantes, estas y celebraciones.
- Interruptor de calentamiento independiente.
- Base con apoyos antideslizantes.
- Desmontable.

- Made of high quality 18/10 stainless steel.
- Creates a cascade of melted chocolate and keeps it warm for dipping foods.
- Ideal for buffets, hotels, restaurants, parties and celebrations.
- Independent heating switch.
- Base with non-slip feet.
- Removable

Características · Characteristics:

Referencia · Reference: 69318
Tensión · Voltage: 220-240 V; 50-60 Hz
Potencia · Power: 35 W
Temperatura · Temperature: 40°C-50°C
Capacidad · Capacity: 0,50 L
Dimensiones · Sizes: Ø16x30 cm
Peso · Weight: 1,15 kg

Características · Characteristics:

Referencia · Reference: 69319
Tensión · Voltage: 220-240 V; 50-60 Hz
Potencia · Power: 80 W
Temperatura · Temperature: 40°C-50°C
Capacidad · Capacity: 1,80 L
Dimensiones · Sizes: Ø23x54,5 cm
Peso · Weight: 2,05kg

PLACAS INDUCCIÓN

Colección



ES

- Placas de inducción rápidas, eficaces, seguras, fiables y de gran capacidad de calentamiento.
- Sus diseños portátiles y compactos resultan ideales para su uso en cualquier lugar.
- Botones táctiles, intuitivos y fáciles de utilizar con un toque suave.
- Dispone de función de bloqueo de seguridad para niños.
- 40% ahorro de tiempo y energía respecto a otras placas convencionales.

FR

- Plaque à induction rapide, efficace, sûre, fiable et d'une grande capacité de chauffe.
- Sa conception portable et compacte est idéale pour une utilisation n'importe où.
- Boutons tactiles, intuitifs et faciles à utiliser avec un toucher doux.
- Dispose d'une fonction de blocage de sécurité pour les enfants.
- 40% de gain de temps et d'économies d'énergies par rapport à d'autres plaques conventionnelles.

EN

- Fast, efficient, safe, reliable induction hob with high heating capacity.
- Its portable and compact design is ideal for use anywhere.
- Intuitive and easy to use soft touch buttons.
- Includes a child safety lock function.
- 40% saving in time and energy compared to other conventional hobs.

Superficie de calentamiento
Heating surface



IPX3
proof

Superficie de calentamiento
Heating surface



Placa inducción profesional CHEF

Plaque induction professionnelle · Profi-Induktionsplatte
Professional induction cooktop · Placa de indução profissional

Ref	€	W	U.Venta
69132	431,40	3500	1

Placa inducción profesional ROCA

Plaque induction professionnelle · Profi-Induktionsplatte
Professional induction cooktop · Placa de indução profissional

Ref	€	W	U.Venta
69337	364,70	2700	1

Ref	Tensión/Voltage	Potencia/Power	Niveles Pot. /P. levels	Temperatura/Temp.	Reloj/Timer	Dimensiones/Sizes	Peso/Weight
69132	220-240 V; 50/60 Hz	3500 W	17	35°C - 240°C	0 - 180 min	34x43x12 cm	7,35 Kg
69337	220-240 V; 50/60 Hz	2700 W	10	60°C - 240°C	0 - 180 min	30x39x10 cm	5,40 Kg

Superficie de calentamiento
Heating surface



Placa inducción profesional EASY

Plaque induction professionnelle · Profi-Induktionsplatte
Professional induction cooktop · Placa de indução profissional

Ref	€	W	U.Venta
69362	370,10	3500	1

Superficie de calentamiento
Heating surface



Posibilidad de encastrar
Encastrable option

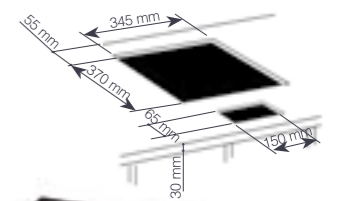

Regulable en potencia
Adjustable in power

Placa de inducción PRO

Table de cuisine à induction · Induktionskochfeld
Induction cooker · Placa de indução

Ref	€	W	U.Venta
69371	333,90	500/3500	1

Superficie de calentamiento
Heating surface



Posibilidad de encastrar
Encastrable option

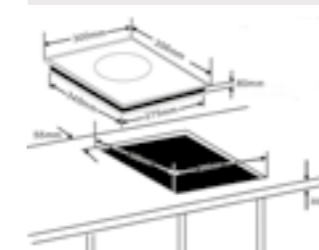

Placa de inducción EXPERT

Table de cuisine à induction · Induktionskochfeld
Induction cooker · Placa de indução

Ref	€	W	U.Venta
69032	279,30	2000	1

Superficie de calentamiento
Heating surface

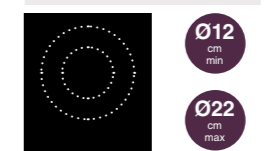

Placa de inducción SLIM

Table de cuisine à Induktion · Induktionskochfeld
Induction cooker · Placa de indução

Ref	€	W	U.Venta
69332	158,40	2000	1

Ref	Tensión/Voltage	Potencia/Power	Niveles Pot. /P. levels	Reloj/Timer	Dimensiones/Sizes	Peso/Weight
69032	220-240 V; 50/60 Hz	2000 W	6	0 - 180 min	31x36x7,5 cm	2,90 Kg
69332	220-240 V; 50/60 Hz	2000 W	8	0 - 180 min	30x37x4,5 cm	2,67 Kg

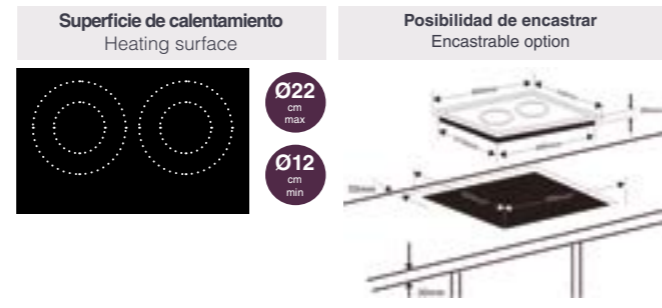

Placa inducción DUAL VERTICAL

Plaque induction double · Induktionskochfeld doppelt
Double induction cooktop · Placa de indução dupla

Ref	€	W	U.Venta
69033	457,20	1800+1300	1

Placa inducción DUAL HORIZONTAL

Plaque induction · Induktionskochfeld doppelt
Induction cooktop · Placa de indução

Ref	€	W	U.Venta
69333	270,20	2000+1500	1

Ref	Tensión/Voltage	Potencia/Power	Niveles Pot./P. levels	Reloj/Timer	Dimensiones/Sizes	Peso/Weight
69033	220-240 V; 50/60 Hz	1800 +1300 W	8	0 - 99 min	29x51x9 cm	4,50 Kg
69333	220-240 V; 50/60 Hz	2000 W + 1500 W	7	0 - 180 min	60x34x7,5 cm	5,20 Kg

ENERGY

Placa vitrocerámica



Superficie de calentamiento
Heating surface



Placa vitrocerámica ENERGY

Plaque vitrocéramique · Keramikkochfeld
Ceramic hob · Placa vitrocerámica

Ref	€	W	U.Venta
69232	112,30	2000	1

- Placa vitrocerámica rápida, eficaz, segura, fiable y de gran capacidad de calentamiento.
- Su diseño portátil y compacto resulta ideal para su uso en cualquier lugar.
- Área de cocción de 10 cm / 20 cm de diámetro.
- Botones táctiles, intuitivos y fáciles de utilizar con un toque suave.
- Indicadores luminosos.
- Dispone de función de bloqueo de seguridad para niños.
- Regulable en potencia y temperatura.
- Temporizador de 240 minutos con avisador acústico y auto desconexión.

- Plaque vitrocéramique rapide, efficace, sûre, fiable et d'une grande capacité de chauffe.
- Sa conception portable et compacte est idéale pour une utilisation n'importe où.
- Zone de cuisson de 10 cm / 20 cm de diamètre.
- Boutons tactiles, intuitifs et faciles à utiliser avec un toucher doux.
- Indicateurs lumineux.
- Dispose d'une fonction de blocage de sécurité pour les enfants.
- Réglable en puissance et en température.
- Minuteur de 240 minutes avec alerte sonore et arrêt automatique.

- Fast, efficient, safe, reliable ceramic hob with high heating capacity.
- Its portable and compact design is ideal for use anywhere.
- 10 cm / 20 cm diameter cooking area.
- Intuitive and easy to use soft touch buttons.
- Luminous indicators.
- Includes a child safety lock function.
- Adjustable power and temperature.
- 240-minute timer with audible warning and auto-off.

Ref	Tensión/Voltage	Potencia/Power	Temperatura/Temp.	Temporizador/Timer	Ø cocción/Cooking	Dimensiones/Sizes	Peso/Weight
69232	220-240 V; 50/60 Hz	2000 W (8 levels)	60°C - 600°C (8 levels)	0 - 240 min (8 levels)	10 cm / 20 cm	39x32x5,5 cm	2,60 Kg

Placa cerámica: Ø26 cm
Ceramic plate: Ø26 cm

Inox



- Cuerpo fabricado en 3 capas: acero inoxidable 18/10, aluminio, acero inoxidable 18%.
- La capa exterior es de acero inoxidable con componentes ferríticos, lo que la convierte totalmente compatible con las cocinas de inducción.
- Los mango fabricado en acero inoxidable 18/10 y recubierto con un protector térmico de silicona
- Body manufactured in a 3-layered: 18/19 stainless steel, aluminium, 18% stainless steel.
- Exterior layer, of stainless steel with ferrite materials, making it completely compatible with induction cookers.
- The grip are made in 18/10 stainless steel and covered in a silicon heat protection.



Placa inducción wok Profesional

Plaque à induction wok professionnelle · Induktionskochplatte wok professional
Induction cooktop wok professional · Placa indução wok profissional

Ref	€	U.Venta
69138	448,00	1

Wok Trimetal

Wok Trimetal · Wok, Trimetal
Trimetal wok · Wok Trimetal

Ref	€	Ø (cm)	L
53836	174,40	36	5,50

Ref	Tensión/Voltage	Potencia/Power	Temperatura/Temp	Tiempo/Timer	Dimensiones/Sizes	Peso/Weight
69138	220-240 V; 50/60 Hz	3500 W	60°C - 240°C	0 - 180 min	34x44,5x12,5 cm	7,50 Kg

PLACA CALENTAMIENTO

Colección

· Professional use ·



Calentador BUFFET 3x GN 1/3

Chauffe · Warmer
Warmer · Aquecedor

Ref	€	W	U.Venta
69445	99,70	300	1



Placa calentamiento

Plaque pour Chauffante · Warmhalteplatte
Warming Plate · Placa aquecimiento

Ref	€	W	U.Venta
69045	92,50	300	1



Placa calentamiento Vitrocerámica

Plaque vitrocéramique chaleur · Glaskeramikeizplatte
Hob heating plate · Placa aquecimiento vitrocerámica

Ref	€	W	U.Venta
69145	204,70	230	1

- Una solución perfecta para profesionales de hostelería, buffet, eventos, catering, ferias, etc.
- Ideal para mantener los alimentos calientes antes de servirlos en la mesa a una temperatura perfecta.
- NO cocinar sobre la misma placa.

- Une solution parfaite pour les professionnels de l'hôtellerie, buffets, événements, traiteurs, salons, etc.
- Idéale pour garder au chaud d'aliments avant de les servir à table à une température parfaite.
- NE PAS cuisiner sur la même plaque.

- A perfect solution for hospitality, buffet, events, catering and trade show professionals...
- Ideal for keeping the food warm before serving them at a perfect temperature.
- DO NOT cook on the same tray.

- Una solución perfecta para profesionales de hostelería, buffet, eventos, catering, ferias, etc.
- Ideal para mantener tanto platos como bandejas de alimentos calientes antes de servirlos en la mesa a una temperatura perfecta.
- Fabricada en vidrio templado con un marco de aluminio.
- Termostato regulable en temperatura (65°C - 105°C).
- Prohibido cocinar sobre la misma placa.

- Une solution parfaite pour les professionnels de l'hôtellerie, buffets, événements, traiteurs, salons, etc.
- Idéale pour garder au chaud aussi bien les assiettes que les plats d'aliments avant de les servir à table à une température parfaite.
- Fabriqué en verre trempé avec un cadre en aluminium.
- Thermostat réglable en température (65°C - 105°C).
- Il est strictement interdit de cuisiner sur la plaque.

- A perfect solution for hospitality, buffet, events, catering and trade show professionals, etc.
- Ideal for keeping both dishes and trays of food warm before serving them at a perfect temperature.
- Made of tempered glass with an aluminum frame.
- Temperature-adjustable thermostat (65°C - 105°C).
- Do not cook on the hot plate.

New



Placa calentamiento Vitrocerámica

Plaque vitrocéramique chaleur · Glaskeramikeizplatte
Hob heating plate · Placa aquecimiento vitrocerámica

Ref	€	W	U.Venta
69446	101,30	230	1

BUFFET

Calentador



ES

- Ideal para grandes cocinas, buffet, catering o comedores.
- Mantiene los platos a temperatura perfecta durante un tiempo prolongado.
- Estructura de acero inoxidable de alta calidad y resistente.
- Placa calentadora de acero inoxidable con regulación de temperatura entre 40°C - 90°C.
- Lámparas halógenas para garantizar una temperatura homogénea con regulación independiente para cada una de ellas.
- Pantalla protectora de plexiglás altamente resistente.

FR

- Idéal pour grandes cuisines, buffets, traiteurs ou cantines.
- Maintient les plats à la température parfaite pendant un laps de temps prolongé.
- Structure en acier inoxydable de grande qualité et résistant.
- Plaque chauffante en acier inoxydable avec réglage de température de 40°C à 90°C.
- Ampoules halogènes pour garantir une température homogène avec réglage indépendant pour chacune d'entre elles.
- Écran de protection en plexiglas hautement résistant.

EN

- Perfect for large kitchens, buffets, catering or dining rooms.
- It keeps food at the perfect temperature for an extended period.
- Durable high quality stainless steel structure.
- Stainless steel heating plate with adjustable temperature from 40° C to 90° C.
- The halogen lamps guarantee even temperature and each one can be adjusted independently.
- High impact perspex safety screen.



Incluye bombillas infrarrojos (Ref.: R69061A)
Includes infrared heating bulbs



Calentador BUFFET DUAL

Plaque électrique · Warmhalteplatte
Electric warming plate · Placa aquecimiento eléctrico

Ref	€	W (Placa)	W (Lámp.)	U.Venta
69562	519,20	500	2x250	1



Calentador BUFFET TRIPLE

Plaque électrique · Warmhalteplatte
Electric warming plate · Placa aquecimiento eléctrico

Ref	€	W (Placa)	W (Lámp.)	U.Venta
69563	684,10	650	3x250	1

Ref	Tensión/Voltage	Potencia/Power	Contenedor/Container	Temp. máx./ Max. temp.	Placa/Plate	Dimensiones/Sizes	Peso/Weight
69445	220-240 V; 50/60 Hz	300 W	GN 1/3 - 2,5 L (3)	80°C (max)	53x35,8 cm	65x38x15,4 cm	4,20 Kg
69045	220-240 V; 50/60 Hz	300 W	-	80°C (max)	53x35,5 cm	65x38x6,2 cm	2,60 Kg
69145	220-240 V; 50/60 Hz	230 W	-	60°C - 105°C (max)	55x36,5 cm	62x36,5x4,5 cm	4,10 Kg
69446	220-240 V; 50/60 Hz	230 W	-	60°C - 105°C (max)	38x45 cm	58x38x2,5 cm	3,54 Kg

Ref	Tensión/Voltage	Pot. Placa/Plate P.	Nº Lámp./Lamps	Pot. Lámp./Lamp P.	Temperatura/Temp.	Dimensiones/Sizes	Peso/Weight
69562	220-240 V; 50/60 Hz	500 W	2	250 W	40°C - 90°C	78x53x70 cm	12,5 Kg
69563	220-240 V; 50/60 Hz	650 W	3	250 W	40°C - 90°C	107x53x70 cm	16,5 Kg

CALENTAMIENTO

Lámparas

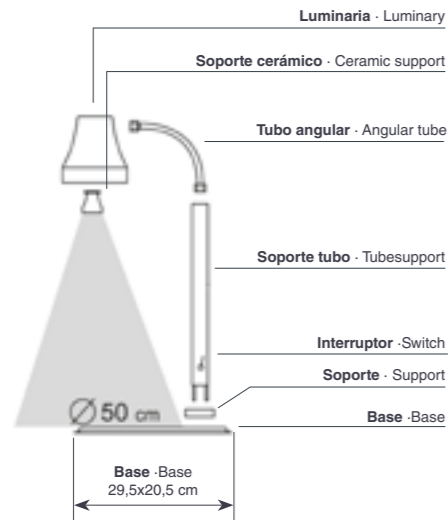

- Para uso profesional en hostelería.
- Mantiene calientes los platos. Calentamiento por infrarrojos.
- Se aconseja mantener la lámpara a 50 - 60 cm de distancia de los platos.
- Bombilla para todas nuestras lámparas de calentamiento.

- Pour un usage professionnel en hôtellerie.
- Maintient les plats au chaud. Chauffe par infrarouges.
- Il est conseillé de maintenir la lampe à une distance de 50 - 60 cm des plats.
- Ampoule pour toutes nos lampes chauffantes.

- For professional catering use.
- Hält die Speisen warm. Infrarot heating.
- It is recommended that the lamp is kept at a distance of 50-60cm from the plates.
- Bulb for all our heating lamps..



Incluye bombillas infrarrojos (Ref.: R69061A)
Includes infrared heating bulbs

Apta para todas nuestras lámparas de calentamiento
Suitable for all our heating lamps

Bombilla infrarrojos
Ampoule infrarouge · Infrarot Glühbirne
Infrared heating bulb · Lampada infravermelho

Ref	€	W	U.Venta
R69061A	9,80	275	1



Lámpara calentamiento infrarrojos
Lampe de chauffage infrarouge · Infrarot Wärmelampe
Infrared heating lamp · Lampara calor infravermelho

Ref	€	W	U.Venta
A 69361	105,10	275	1
B 69061	145,40	550	1

Ref	Tensión/Voltage	Potencia/Power	Dimensiones/Sizes	Peso/Weight
69361	220-240 V; 50/60 Hz	275 W	34x33x56 -71 cm	1,15 Kg
69061	220-240 V; 50/60 Hz	550 W	36x45x61 - 75 cm	1,58 Kg
69263	220-240 V; 50/60 Hz	275 W	31x23x79 cm	6,0 Kg
69264	220-240 V; 50/60 Hz	550 W	36x36x76 cm	7,0 Kg



Lámpara de calentamiento infrarrojos
Lampe de chauffage infrarouge · Infrarot Wärmelampe
Infrared heating lamp · Lampara calor infravermelho

Ref	€	W	U.Venta
A 69263	473,50	275	1
B 69264	615,50	550	1

CALENTAMIENTO

Lámparas extensibles

· Professional use ·



- Para uso profesional en hostelería.
- Mantiene calientes los platos. Calentamiento por infrarrojos.
- Se aconseja mantener la lámpara a 50 - 60 cm de distancia de los platos.
- Bombilla para todas nuestras lámparas de calentamiento.

- Pour un usage professionnel en hôtellerie.
- Maintient les plats au chaud. Chauffe par infrarouges.
- Il est conseillé de maintenir la lampe à une distance de 50 - 60 cm des plats.
- Ampoule pour toutes nos lampes chauffantes.

- For professional catering use.
- Keeps the dishes warm. Infrared heating.
- It is recommended that the lamp is kept at a distance of 50-60cm from the plates.
- Bulb for all our heating lamps.



Incluye bombillas infrarrojos (Ref.: R69061A)
Includes infrared heating bulbs



Lámpara calentamiento infrarrojos cable extensible
Lampe de chauffage câble extensible · Infrarot Wärmelampe Kabel ausziehbar
Infrared heating lamp extensible · Lampara calor infravermelho cabo extensível

Ref	€	W	U.Venta	Finish
A 69266	126,70	275	1	Lijado · Sanding
B 69365	145,60	275	1	Cromado · Chrome
C 69367	145,60	275	1	Cobre · Copper
D 69359	137,40	275	1	Negra · Black

Lámpara de calentamiento extensible cónica
Lampe chauffante extensible conique · Wärmelampe Kabel ausziehbar, konisch
Conical heating lamp extensible · Lampada de aquecimento ext. cônica

Ref	€	W	U.Venta	Finish
A 69564	131,20	275	1	Lijado · Sanding
B 69566	157,50	275	1	Cromado · Chrome
C 69565	160,20	275	1	Cobre · Copper
D 69576	147,00	275	1	Negra · Black

Ref	Tensión/Voltage	Potencia/Power	Dist. lámp. alimentos Lamp-food distance	Peso/Weight
69266	220-240 V; 50/60 Hz	275 W	50 - 60 cm	2,00 Kg
69365	220-240 V; 50/60 Hz	275 W	50 - 60 cm	2,00 Kg
69367	220-240 V; 50/60 Hz	275 W	50 - 60 cm	2,00 Kg
69359	220-240 V; 50/60 Hz	275 W	50 - 60 cm	2,00 Kg
69564	220-240 V; 50/60 Hz	275 W	50 - 60 cm	1,60 Kg
69566	220-240 V; 50/60 Hz	275 W	50 - 60 cm	1,60 Kg
69565	220-240 V; 50/60 Hz	275 W	50 - 60 cm	1,60 Kg
69576	220-240 V; 50/60 Hz	275 W	50 - 60 cm	1,60 Kg

CALENTADORAS

Ollas



ES

- Mantiene caliente todo tipo de sopas, salsas, consomés y líquidos.
- Ideal para cantidades grandes.
- Control de temperatura regulable por termostato.
- Cubeta interior desmontable.
- Alta resistencia y durabilidad.

FR

- Maintenir au chaud tout type de soupes, sauces, consommés, liquides, etc.
- Idéal pour de grandes quantités.
- Contrôle de la température réglable par thermostat.
- Seau intérieur amovible.
- Haute résistance et durabilité.

EN

- Keep all kinds of soups, sauces, consommés, liquids etc hot.
- Ideal for large amounts.
- Temperature control adjustable by thermostat.
- Removable inner bucket.
- High resistance and durability.

A
Inox 18/10



Capacidad: 10 L / Medidas: Ø24x25 cm
Repuesto para las ref.: 69037-69038
Capacity: 10 l / Sizes: Ø24x25 cm
Replacement for ref.: 69037-69038



B



C



Olla calentador sopa PROFESIONAL

Marmite Buffet chaud · Suppen-und Speisenwärmer
Soup kettle · Panela aquecedora de sopa

Ref	€	U.Venta	
A 69267	289,90	1	Inox 18/10 · 18/10 stainless steel
B 69037	173,90	1	Hierro esmaltado · Enameled iron
C 69038	245,20	1	Inox · St steel
D 69039	58,10	1	Repuesto · Replacement (69037-69038)

Ref	Tensión/Voltage	Potencia/Power	Temperatura/Temp.	Capacidad/Capacity	Dimensiones/Sizes	Peso/Weight
69267	220-240 V; 50/60 Hz	800 W	30°C - 90°C	11,0 L	Ø33x32 cm	4,50 Kg
69037	220-240 V; 50/60 Hz	400 - 475 W	30°C - 90°C	10,0 L	Ø34,5x36 cm	4,50 Kg
69038	220-240 V; 50/60 Hz	400 - 475 W	30°C - 90°C	10,0 L	Ø34,5x36 cm	4,50 Kg

VITRINAS

Colección



Parte trasera. Puertas traseras abatibles
Back side. Hinged rear doors



Vitrina neutra
Vitrine neutre · Einfache vitrine
Clear countertop display case · Vitrina neutra

Ref	€	cm	h (cm)	L	U.Venta
69601	285,30	55,4x37,6	37	45	1



Rejilla extraíble, facilita el flujo del calor
Removable racks for better heat flow



Parte trasera. Puertas traseras abatibles
Back side. Hinged rear doors



Vitrina térmica
Vitrine thermique · Warmhaltevitrine
Thermal display case · Vitrina térmica

Ref	€	W	L	U.Venta
69604	577,00	800	45	1

Ref	Tensión/Voltage	Pot./Power	Capacidad/Capacity	Temp./Temp.	Protec./Protection	Parrilla/Grill	Parrilla/Grill (h)	Dimensiones/Sizes	Peso/Weight
69604	220-240 V; 50 Hz	800	45	30°C - 90°C	IPX4	52,5x28,5 cm	8,5 cm / 10 cm	55,4x37,6x37,6 cm	14,4 Kg

- Vitrina neutra construida íntegramente en cristal y base de acero inoxidable.
- Diseñada para presentar y exponer sobre la barra / mostrador.
- Superficie superior curvada para una visión panorámica.
- Estante intermedio de cristal templado.
- Puerta trasera abatible.
- 4 pies de goma que garantizan máxima estabilidad.

- Vitrine neutre íntegramente fabriquée en verre et base en acier inoxydable.
- Conçue pour présenter et exposer sur le plan de travail / comptoir.
- Surface supérieure courbée pour une vision panoramique.
- Étagère intermédiaire en verre trempé.
- Porte arrière rabattable.
- 4 pieds en caoutchouc qui garantissent une qualité maximale.

- Clear countertop display case made entirely of glass, including a stainless steel base.
- Designed for presenting and displaying food on the bar/countertop.
- Full view curved upper surface.
- Middle shelf made of tempered glass.
- Hinged rear door.
- 4 rubber feet for maximum stability.

- Vitrina térmica fabricada en acero inoxidable y cristal.
- Diseñada para conservar, presentar y exponer sobre la barra / mostrador.
- Puerta trasera abatible.
- Superficie superior inclinada para una visión panorámica.
- Recipiente de agua extraíble que aporta humedad en la cámara.
- Termostato de control de temperatura regulable: 30-90°C.
- Bandeja de rejilla extraíble que facilita el flujo del calor.

- Vitrine thermique fabriquée en acier inoxydable et verre.
- Conçue pour conserver, présenter et exposer sur le plan de travail / comptoir.
- Porte arrière rabattable.
- Surface supérieure inclinée pour une vision panoramique.
- Récipient d'eau extractible qui apporte de l'humidité à la chambre.
- Thermostat de contrôle pour régler la température : 30-90°C.
- Plateau grillagé extractible qui facilite le flux de chaleur.

- Thermal display case made of stainless steel and glass.
- Designed for storing, presenting and displaying food on the bar/countertop.
- Hinged rear door.
- Full view curved upper surface.
- Removable water tray to keep the chamber moist.
- Adjustable temperature control thermostat: 30-90°C.
- Removable racks for better heat flow.



Parte trasera.
Puertas traseras correderas.
4 / 6 cubetas gastronorm 1/3 incluidas
Back side.
Sliding rear doors.
4/6 Gastronorm 1/3 trays included

IPX4



4
Cubetas
Containers



6
Cubetas
Containers

Vitrina Térmica

Vitrine thermique · Warmhaltevitrine
Thermal display case · Vitrina térmica

Ref	€	W	Capacidad	U.Venta
A 69602	636,20	500	4xGN1/3	1
B 69603	731,40	800	6xGN1/3	1

- Vitrina térmica fabricada en acero inoxidable y cristal.
 - Diseñada para conservar, presentar y exponer sobre la barra / mostrador.
 - Puertas correderas para una accesibilidad total.
 - Superficie superior curvada para una visión panorámica.
 - 4 / 6 cubetas gastronorm 1/3 incluidas.
 - Termostato de control de temperatura regulable: 30 - 90°C.
- Vitrine thermique fabriquée en acier inoxydable et verre.
 - Conçue pour conserver, présenter et exposer sur le plan de travail / comptoir.
 - Portes coulissantes pour une accessibilité totale.
 - Surface supérieure courbée pour une vision panoramique.
 - 4 / 6 bacs gastronome 1/3 inclus.
 - Thermostat de contrôle pour régler la température : 30 - 90°C.
- Thermal display case made of stainless steel and glass.
 - Designed for storing, presenting and displaying food on the bar/countertop.
 - Sliding doors for easy access.
 - Full view curved upper surface.
 - 4/6 Gastronorm 1/3 trays included.
 - Adjustable temperature control thermostat: 30 - 90°C.

69602 Combinaciones posibles Possible combinations				69603 Combinaciones posibles Possible combinations		
GN 2/3	GN 2/3	GN 2/3	GN 2/3	GN 2/3	GN 2/3	GN 2/3
GN 1/3	GN 1/3	GN 1/3	GN 1/3	GN 1/2	GN 1/2	GN 1/2
GN 1/3	GN 1/3	GN 1/3	GN 1/3	GN 1/3	GN 1/3	GN 1/3



Control de temperatura regulable
Temperature control thermostat



Tubo desagüe con tapón
Drain tube with cap

Puertas traseras correderas
Sliding rear doors



4
Cubetas
Containers



6
Cubetas
Containers



Vitrina refrigerada

Vitrine réfrigérée · Kühlvitrine
Refrigerated display case · Vitrina refrigerada

Ref	€	W	Capacidad	U.Venta
A 69605	1.236,70	160	4xGN1/3	1
B 69606	1.371,10	160	6xGN1/3	1

Ref	Tensión/Voltage	Potencia/Power	Capacidad/Capacity	Temperatura/Temp.	Refrigerante/Refrig.	Dimensiones/Sizes	Peso/Weight
69605	220-240 V; 50Hz	160 W	4 x GN 1/3	0°C - 12°C	R600a	112,1x45x33 cm	33 Kg
69606	220-240 V; 50 Hz	160 W	6 x GN 1/3	0°C - 12°C	R600a	148,3x45x33 cm	39 Kg

- Vitrina refrigerada construida íntegramente en cristal y acero inoxidable.
- Diseñada para conservar, presentar y exponer sobre la barra / mostrador.
- Puertas correderas para una accesibilidad total.
- Superficie superior curvada para una visión panorámica.
- Sistema de enfriamiento por compresor.
- 4 / 6 cubetas gastronorm 1/3 incluidas.
- Termostato de control de temperatura regulable: 0-12°C.
- Sistema de iluminación LED en la cámara interior y display de control de mandos.

- Vitrine réfrigérée intégralement fabriquée en verre et acier inoxydable.
- Conçue pour conserver, présenter et exposer sur le plan de travail / comptoir.
- Portes coulissantes pour une accessibilité totale.
- Surface supérieure courbée pour une vision panoramique.
- Système de refroidissement par compresseur.
- 4 / 6 bacs gastronome 1/3 inclus.
- Thermostat de contrôle pour régler la température : 0-12°C.
- Système d'éclairage LED dans la chambre intérieure et écran de contrôle de commandes.

- Refrigerated display case made entirely of glass, including a stainless steel base.
- Designed for storing, presenting and displaying food on the bar/countertop.
- Sliding doors for easy access.
- Full view curved upper surface.
- Compressor cooling system.
- 4/6 Gastronorm 1/3 trays included.
- Adjustable temperature control thermostat: 0-12°C.
- LED lighting for inner chamber illumination and control display unit.

Parte trasera
Back side



Vitrina refrigerada

Vitrine réfrigérée · Kühlvitrine
Refrigerated display case · Vitrina refrigerada

Ref	€	W	L	U.Venta
69607	1.084,00	105	40	1

- Vitrina refrigerada construida íntegramente en cristal y acero inoxidable.
- Diseñada para conservar, presentar y exponer sobre la barra / mostrador.
- Puertas correderas para una accesibilidad total.
- Superficie superior inclinada para una visión panorámica.
- Sistema de enfriamiento por compresor. Función Defrost.
- Termostato de control de temperatura regulable: 2-12°C.
- Sist. de iluminación LED en la cámara interior y display de control de mandos.

- Vitrine réfrigérée intégralement fabriquée en verre et acier inoxydable.
- Conçue pour conserver, présenter et exposer sur le plan de travail / comptoir.
- Portes coulissantes pour une accessibilité totale.
- Surface supérieure courbée pour une vision panoramique.
- Système de refroidissement par compresseur.
- Thermostat de contrôle pour régler la température : 0-12°C.
- Syst. d'éclairage LED dans la chambre intérieure et écran de contrôle de commandes.

- Refrigerated display case made entirely of glass, including a st. steel base.
- Designed for storing, presenting and displaying food on the bar/countertop.
- Sliding doors for easy access.
- Full view curved upper surface.
- Compressor cooling system. Defrost function.
- Adjustable temperature control thermostat: 2-12°C.
- LED lighting for inner chamber illumination and control display unit.

Ref	Tensión/Voltage	Potencia/Power	Capacidad/Capacity	Temperatura/Temp.	Refrigerante/Refr.	Dimensiones/Sizes	Peso/Weight
69607	220-240 V; 50Hz	105 W	40	2°C - 12°C	R600a	68x57,5x33,5 cm	25 Kg

CUBETAS

Soportes

Inox
18/10



Diversas combinaciones posibles
Several possible combinations

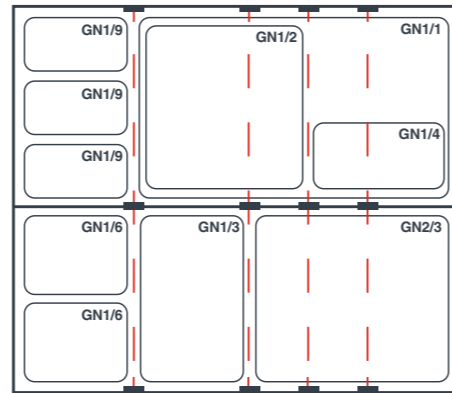

Cubetas GN no incluidas
Bacs GN non inclus



ES

- Fabricado en acero inoxidable 18/10.
- Organiza los alimentos y ahorra tiempo en la preparación de platos.
- Ideal para cocinas profesionales, restaurantes, buffet, autoservicios, etc.
- Travesaños verticales amovibles diseñados para combinar cubetas de distintos tamaños de hasta 200 mm de profundidad.
- Pies de goma antideslizantes que garantizan una óptima estabilidad.

FR

- Fabriqué en acier inoxydable 18/10.
- Organisez les aliments et gagnez du temps lors de la préparation de vos plats.
- Idéal pour les cuisines professionnelles, les restaurants, les buffets, les self-services, etc.
- Barres transversales verticales amovibles conçues pour combiner des bacs de différentes tailles de 200 mm de profondeur.
- Pieds en caoutchouc antidérapants qui garantissent une stabilité optimale.

EN

- Made of 18/10 stainless steel.
- Organize food and save time while making dishes.
- Perfect for professional chefs, restaurants, buffets, self-service, etc.
- It has removable vertical cross pieces designed to combine trays of different sizes to 200 mm deep.
- The non-slip rubber feet ensure optimum stability.



Soporte para cubetas Gastronorm

Support de bacs Gastronorm · Unterstützung für Gastronorm-Küvetten
Gastronorm cuvette support · Suporte de cubeta Gastronorm

	Ref	€	cm	Cubeta (cm)	U.Venta	
A	66245	81,90	78x49x46	34x26,5x2	1	Soporte simple · Simple support
B	66246	105,40	78x78x63	34x26,5x2	1	Soporte doble · Double support

COMPATIBILIDAD DE CUBETAS CON LOS SOPORTES CONTAINERS COMPATIBILITY WITH SUPPORTS

	INOX 18/10	INOX	PC	PP	MELAMINA
<p>GN 2/1 530 mm x 650 mm</p>	X	X			
<p>GN 1/1 530 mm x 325 mm</p>	✓	✓	✓	X	✓
<p>GN 2/3 354 mm x 325 mm</p>	✓	✓	✓		✓
<p>GN 2/4 530 mm x 165 mm</p>	X	X			X
<p>GN 1/2 265 mm x 325 mm</p>	✓	✓	✓	X	✓
<p>GN 1/3 176 mm x 325 mm</p>	✓	✓	✓	✓	✓
<p>GN 1/4 265 mm x 162 mm</p>	X	X	✓	X	X
<p>GN 1/6 176 mm x 162 mm</p>	✓	✓	✓	✓	✓
<p>GN 1/9 176 mm x 108 mm</p>	✓	✓	✓	✓	

INOX 18/10 · INOX

Cubetas

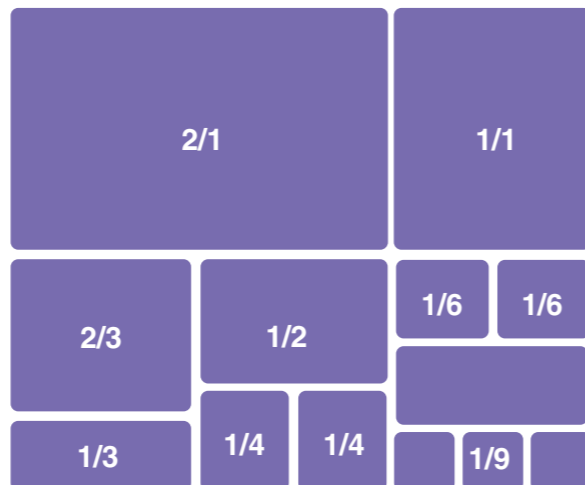

ES

- Fabricadas en acero inoxidable y acero inoxidable 18/10.
- Apilables.
- Aptas para procesos de refrigeración, congelación, hornos microondas o distribución de alimentos.
- Higiénicos y fácilmente lavables, aptas para el lavavajillas.

FR

- Fabriquées en acier inoxydable et en acier inoxydable 18/10.
- Empilables.
- Compatibles pour des processus de réfrigération, congélation, fours à micro-ondes ou distribution d'aliments.
- Hygiéniques et facilement lavables, compatible lave-vaisselle.

EN

- Manufactured in stainless steel and stainless steel 18/10.
- Stackable.
- Suitable for refrigeration and freezing processes, microwave ovens or food distribution.
- Hygienic and easily washable, dishwasher safe.

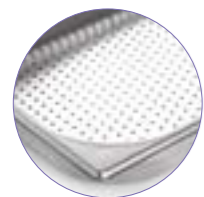

Ø del agujero perforado: Ø4 mm
Drilled hole Ø: Ø4 mm

2/1
530 x 650 mm



Cubeta 2/1

Bac 2/1 · GN-Behälter 2/1
Container 2/1 · Caixa 2/1

Inox 18/10	€	Inox	€	h (mm)	L	U.Venta	
66002	47,30	66002Z	42,00	20	6,50	1	Bandeja
66040	52,30	66040Z	47,40	40	11,00	1	Bandeja
66065	59,60	66065Z	49,90	65	18,90	1	Bandeja
66010	72,80	66010Z	61,00	100	31,50	1	
66015	88,00	66015Z	76,70	150	44,90	1	
66020	114,40	66020Z	102,40	200	60,00	1	

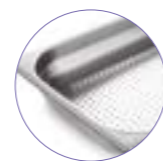

Cubeta perforada 2/1

Bac perforé 2/1 · GN-Behälter, perforiert, 2/1
Perforated container 2/1 · Caixa perforada 2/1

Inox 18/10	€	Inox	€	h (mm)	U.Venta	
-	-	-	-	-	-	-
66042	64,10	-	-	40	1	NO perf. lateral
66067	80,70	66067Z	56,60	65	1	NO perf. lateral
66012	99,40	66012Z	69,70	100	1	NO perf. lateral
66017	148,80	-	-	150	1	NO perf. lateral

1/1
530 x 325 mm



Cubeta 1/1

Bac 1/1 · GN-Behälter 1/1
Container 1/1 · Caixa 1/1

Inox 18/10	€	Inox	€	h (mm)	L	U.Venta	
66102	23,40	66102Z	19,80	20	3,00	1	Bandeja
66140	24,50	66140Z	21,20	40	5,50	1	Bandeja
66155	27,50	66155Z	22,40	55	7,20	1	Bandeja
66165	29,60	66165Z	23,20	65	8,50	1	Bandeja
66110	42,10	66110Z	31,50	100	13,30	1	
66115	50,00	66115Z	43,30	150	20,60	1	
66120	59,00	66120Z	52,50	200	30,00	1	

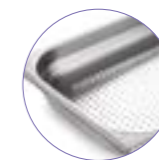

Cubeta perforada 1/1

Bac perforé 1/1 · GN-Behälter, perforiert, 1/1
Perforated container 1/1 · Caixa perforada 1/1

Inox 18/10	€	Inox	€	h (mm)	U.Venta	
66104	35,30	-	-	20	1	NO perf. lateral
66142	41,90	66142Z	23,60	40	1	
-	-	-	-	-	-	-
66167	46,30	66167Z	25,50	65	1	
66112	59,60	66112Z	35,70	100	1	
66117	88,40	66117Z	57,60	150	1	
66122	101,40	66122Z	69,90	200	1	

2/3
354 x 325 mm



Cubeta 2/3

Bac 2/3 · GN-Behälter 2/3
Container 2/3 · Caixa 2/3

Inox 18/10	€	Inox	€	h (mm)	L	U.Venta	
66502	20,30	66502Z	16,70	20	1,70	1	Bandeja
66540	25,60	66540Z	21,70	40	3,50	1	Bandeja
66565	29,30	66565Z	24,50	65	5,50	1	Bandeja
66510	36,40	66510Z	30,50	100	8,90	1	
66515	50,90	66515Z	42,50	150	13,60	1	
66520	67,70	66520Z	56,70	200	19,30	1	

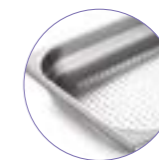

Cubeta perforada 2/3

Bac perforé 2/3 · GN-Behälter, perforiert, 2/3
Perforated container 2/3 · Caixa perforada 2/3

Inox 18/10	€	Inox	€	h (mm)	U.Venta	
-	-	-	-	-	-	-
-	-	-	-	-	-	-
-	-	66567Z	21,90	65	-	
-	-	66512Z	31,30	100	1	
-	-	66517Z	42,50	150	1	

1/2
265 x 325 mm



Cubeta 1/2

Bac 1/2 · GN-Behälter 1/2
Container 1/2 · Caixa 1/2

Inox 18/10	€	Inox	€	h (mm)	L	U.Venta	
66202	15,80	66202Z	11,10	20	1,20	1	Bandeja
66240	16,60	66240Z	11,50	40	2,50	1	Bandeja
-	-	66255Z	12,90	55	3,20	1	Bandeja
66265	18,90	66265Z	13,40	65	4,20	1	Bandeja
66210	27,50	66210Z	18,90	100	8,00	1	
66215	35,30	66215Z	27,20	150	9,90	1	
66220	45,10	66220Z	33,60	200	11,60	1	

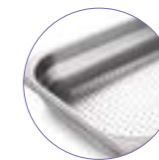

Cubeta perforada 1/2

Bac perforé 1/2 · GN-Behälter, perforiert, 1/2
Perforated container 1/2 · Caixa perforada 1/2

Inox 18/10	€	Inox	€	h (mm)	U.Venta	
-	-	-	-	-	-	-
66242	29,70	-	-	40	1	NO perf. lateral
-	-	-	-	-	-	-
66267	34,10	-	-	65	1	
66212	41,80	-	-	100	1	
66217	56,60	-	-	150	1	
66222	78,60	-	-	200	1	

2/4
530 x 165 mm



Cubeta 2/4

Bac 2/4 · GN-Behälter 2/4
Container 2/4 · Caixa 2/4

Inox 18/10	€	Inox	€	h (mm)	L	U.Venta
67604	22,10	67604Z	18,40	40	1,80	1
67665	25,10	67665Z	20,60	65	4,50	1
67610	31,10	67610Z	25,60	100	5,50	1
67615	47,00	67615Z	38,50	150	8,50	1

1/4
265 x 162 mm



Cubeta 1/4

Bac 1/4 · GN-Behälter 1/4
Container 1/4 · Caixa 1/4

Inox 18/10	€	Inox	€	h (mm)	L	U.Venta
66402	11,10	66402Z	7,60	20	0,60	6
66465	12,40	66465Z	8,40	65	1,90	6
66410	18,50	66410Z	13,00	100	2,50	1
66415	25,40	66415Z	17,40	150	4,10	1
66420	34,60	66420Z	21,00	200	4,90	1

1/9
176 x 108 mm



Cubeta 1/9

Bac 1/9 · GN-Behälter 1/9
Container 1/9 · Caixa 1/9

Inox 18/10	€	Inox	€	h (mm)	L	U.Venta
66965	8,70	66965Z	5,00	65	0,70	6
66910	15,10	66910Z	7,90	100	0,85	6



Doble fondo perforado

Double fond perforé · Doppel-Boden gelocht
Punched double bottom perf. · Duplo fundo perfurado

Inox 18/10	€	Inox	€	Cubeta
66909	109,50	-	-	2/1
66911	34,90	66911Z	23,20	1/1
66912	23,80	66912Z	15,70	1/2

1/3
176 x 325 mm



Cubeta 1/3

Bac 1/3 · GN-Behälter 1/3
Container 1/3 · Caixa 1/3

Inox 18/10	€	Inox	€	h (mm)	L	U.Venta
66302	14,80	66302Z	8,40	20	0,80	6 Bandeja
66340	14,90	66340Z	9,20	40	1,60	6 Bandeja
66355	15,40	66355Z	9,50	55	2,00	6 Bandeja
66365	15,60	66365Z	9,70	65	2,50	6 Bandeja
66310	22,30	66310Z	15,40	100	3,80	1
66315	32,60	66315Z	20,60	150	5,90	1
66320	37,40	66320Z	24,40	200	8,10	1

1/6
176 x 162 mm



Cubeta 1/6

Bac 1/6 · GN-Behälter 1/6
Container 1/6 · Caixa 1/6

Inox 18/10	€	Inox	€	h (mm)	L	U.Venta
66665	10,10	66665Z	6,80	65	1,10	6
66610	16,10	66610Z	10,40	100	1,60	6
66615	25,20	66615Z	14,40	150	2,50	1
66620	31,60	66620Z	17,00	200	3,30	1



Guia divisora

Guide de division · GN Zwischensteg
Splitting guides · Guia divisória

Inox 18/10	€	Inox	€	L (mm)	U.Venta
66923	14,40	66923Z	6,00	530	1
66925	10,70	66925Z	3,90	325	1



Tapa para cubeta

Couvercle pour bac · GN Deckel
Container lid · Tampa para caixa

Inox 18/10	€	Inox	€	Cubeta	U.Venta
-	-	66908DZ	38,20	2/1	1
66901D	26,30	66901DZ	18,20	1/1	1
66905D	20,90	66905DZ	12,50	2/3	1
66907	16,80	-	-	2/4	1
66902D	13,90	66902DZ	8,90	1/2	6
66903D	11,10	66903DZ	6,90	1/3	6
66904D	9,40	66904DZ	6,40	1/4	6
66906D	7,10	66906DZ	3,70	1/6	6
66909D	6,60	66909DZ	2,80	1/9	6



Tapa para cubeta

Couvercle pour bac · GN Deckel
Container lid · Tampa para caixa

Inox 18/10	€	Inox	€	Cubeta	U.Venta
67901	26,20	67901Z	18,30	1/1	1
67905	16,00	67905Z	11,10	2/3	1
67902	14,30	67902Z	9,90	1/2	6
67903	10,40	67903Z	7,10	1/3	6
67904	8,70	67904Z	6,00	1/4	6
67906	7,10	67906Z	5,00	1/6	6
67909	6,00	67909Z	4,20	1/9	6

Inox

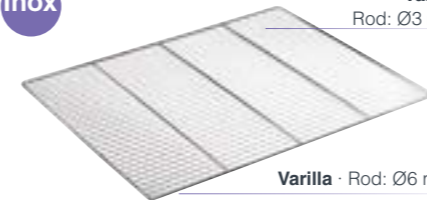

Varilla
Rod: Ø3 mm

Varilla · Rod: Ø6 mm

Parrilla

Grille · GN Drahtgitter
Grill · Grelha

Ref	€	cm	Cubeta	U.Venta
66920	53,60	65x53	2/1	1
66921	20,60	53x32,5	1/1	1



Pinza para horno/bandeja GN

Pince inox pour bac GN · Zange für GN Behälter
Tong GN tray · Pinça para forno e bandejas GN

Ref	€	L (cm)	U.Venta
62989	17,00	20	12

Bandeja



Tapa para cubeta

Couvercle pour bac · GN Deckel
Container lid · Tampa para caixa

Inox 18/10	€	Inox	€	Cubeta	U.Venta
66901	77,50	66901Z	46,30	1/1	1
66903	62,50	66903Z	32,70	2/3	1
66902	56,70	66902Z	36,40	1/2	1
66904	45,90	66904Z	25,40	1/3	1
66905	42,50	66905Z	23,60	1/4	1

Si

200 °C



Pinza para horno/bandeja GN

Pince inox pour bac GN · Zange für GN Behälter
Tong GN tray · Pinça para forno e bandejas GN

Ref	€	L (cm)	U.Venta
62998	17,00	20	12

HELADO Cubetas

- Cubetas fabricadas en acero inoxidable 18/10.
- Diseñados para conservar el helado.
- Bordes perfilados para un agarre óptimo y funcional.
- Tapa fabricada en policarbonato; color transparente.
- Forma de cúpula para una mayor capacidad del helado.

- Bacs fabriqués en acier inoxydable de la plus grande qualité.
- Conçus pour conserver la glace.
- Bords profilés pour une prise en main optimale et fonctionnelle.
- Couvrete transparent fabriqué en polycarbonate.
- Forme de coupole pour une plus grande capacité de glace.

- Top quality stainless steel pans.
- Designed for storing ice cream.
- Shaped edges for optimal and functional handling.
- Polycarbonate lid, transparent colour.
- Dome shaped for greater ice cream capacity.



Cubeta para helado

Bac à glace · Eiskübel
Ice cream container · Caixa de sorvete

Ref	€	cm	h (cm)	L	U.Venta
66178	27,10	36x16,5	8,0	3,8	1
66172	27,20	36x16,5	12,0	5,0	1
66175	34,30	36x16,5	15,0	6,5	1
66900P	9,60	36x16,5	7,6	-	1

A

Tapa · Lid

- Fabricados en policarbonato, color transparente.
- Diseñados para conservar el helado.
- Bordes perfilados para un agarre óptimo y funcional.
- Tapa fabricada en policarbonato; color transparente.
- Tapa con asa para fácil manejo.

- Made of polycarbonate, transparent colour.
- Designed for storing ice cream.
- Shaped edges for optimal and functional handling.
- Polycarbonate lid, transparent colour.
- Lid with handle for easy handling.

New

A- Compatible con tapas (66900P/66908P)
Compatible with lids (66900P/66908P)
B- Compatible con cubetas (66175/66172P)
Compatible with containers (669175/66172P)

PC
polycarbonate



Cubeta para helado

Bac à glace · Eiskübel
Ice cream container · Caixa de sorvete

Ref.	€	cm	h (cm)	L	U.Venta
66172P	9,60	36x16,5	12,0	5,0	6
66908P	6,60	36x16,5	2,0	-	6

A

B

POLICARBONATO

Cubetas



ES

- Fabricadas en policarbonato.
- Ligeras, indeformables y apilables.
- Aptas para procesos de refrigeración, congelación, hornos microondas o distribución de alimentos (-100°C/100°C).
- Higiénicos y fácilmente lavables, aptas para el lavavajillas.

1/1
530 x 325 mm



Cubeta 1/1

Bac 1/1 · GN-Behälter 1/1
Container 1/1 · Caixa 1/1

Ref	€	h (mm)	L	U.Venta
66165P	23,40	65	8,50	1
66110P	28,80	100	13,30	1
66115P	35,30	150	20,60	1
66120P	43,50	200	30,00	1

1/4
265 x 162 mm



Cubeta 1/4

Bac 1/4 · GN-Behälter 1/4
Container 1/4 · Caixa 1/4

Ref	€	h (mm)	L	U.Venta
66465P	9,00	65	1,90	1
66410P	10,70	100	2,50	1
66415P	13,50	150	4,10	1



Tapa

Couvercle · Deckel
Lid · Tampa

Ref	€	Cubeta	U.Venta
66901P	17,80	1/1	1
66902P	11,00	1/2	1
66903P	7,80	1/3	1
66904P	6,40	1/4	1
66906P	4,80	1/6	1
66909P	3,80	1/9	1

FR

- Fabriquées en polycarbonate.
- Légères, indéformables et empilables.
- Compatibles pour des processus de réfrigération, congélation, fours à micro-ondes ou distribution d'aliments (-100°C/100°C).
- Hygiéniques et facilement lavables, compatible lave-vaisselle.

1/2
265 x 325 mm



Cubeta 1/2

Bac 1/2 · GN-Behälter 1/2
Container 1/2 · Caixa 1/2

Ref	€	h (mm)	L	U.Venta
66265P	12,40	65	4,20	1
66210P	16,40	100	8,00	1
66215P	21,20	150	9,90	1
66220P	25,90	200	11,60	1

1/6
176 x 162 mm



Cubeta 1/6

Bac 1/6 · GN-Behälter 1/6
Container 1/6 · Caixa 1/6

Ref	€	h (mm)	L	U.Venta
66665P	7,60	65	1,10	1
66610P	8,10	100	1,60	1
66615P	9,70	150	2,50	1



Doble fondo perforado

Double fond perfore · GN Einlege-Böden, gelocht
Punched double bottom · Duplo fundo perfurado

Ref	€	Cubeta	U.Venta
66911P	13,30	1/1	1
66912P	7,30	1/2	1
66913P	4,70	1/3	1
66914P	3,70	1/4	1
66916P	3,30	1/6	1

EN

- Manufactured in polycarbonate.
- Light, non-deformable and stackable.
- Suitable for refrigeration and freezing processes, microwave ovens or food distribution (-100°C/100°C).
- Hygienic and easily washable, dishwasher safe.

1/3
176 x 325 mm



Cubeta GN 1/3

Bac GN 1/3 · GN-Behälter 1/3
GN container 1/3 · Caixa GN 1/3

Ref	€	h (mm)	L	U.Venta
66365P	10,10	65	2,50	1
66310P	13,10	100	3,80	1
66315P	16,30	150	5,90	1
66320P	19,90	200	8,10	1

1/9
176 x 108 mm



Cubeta 1/9

Bac 1/9 · GN-Behälter 1/9
Container 1/9 · Caixa 1/9

Ref	€	h (mm)	L	U.Venta
66910P	7,60	100	0,70	1

POLIPROPILENO

Cubetas



ES

- Fabricadas en polipropileno.
- Ligeras, indeformables y apilables.
- Cierre hermético. Higiénicas y fácilmente lavables.
- Aptas para procesos de refrigeración, congelación o distribución de alimentos (-40°C/70°C).

1/1
530 x 325 mm



Cubeta 1/1

Bac 1/1 · GN-Behälter 1/1
Container 1/1 · Caixa 1/1

Ref	€	h (mm)	L	U.Venta
66165H	11,00	65	8,50	1
66110H	13,10	100	12,90	1
66115H	16,40	150	19,50	1
66120H	21,00	200	25,90	1

1/4
265 x 162 mm



Cubeta 1/4

Bac 1/4 · GN-Behälter 1/4
Container 1/4 · Caixa 1/4

Ref	€	h (mm)	L	U.Venta
66465H	3,80	65	1,70	6
66410H	5,10	100	2,40	6
66415H	5,50	150	3,70	6



Tapa

Couvercle · Deckel
Lid · Tampa

Ref	€	Cubeta	U.Venta
66901DH	8,30	1/1	6
66902DH	4,90	1/2	6
66903DH	3,60	1/3	6
66904DH	3,00	1/4	6
66906DH	2,10	1/6	6
66909DH	2,00	1/9	6

FR

- Fabriquées en polycarbonate.
- Légères, indéformables et empilables.
- Fermeture hermétique. Hygiéniques et facilement lavables.
- Compatibles pour des processus de réfrigération, congélation ou distribution d'aliments (-40°C/70°C).

1/2
265 x 325 mm



Cubeta 1/2

Bac 1/2 · GN-Behälter 1/2
Container 1/2 · Caixa 1/2

Ref	€	h (mm)	L	U.Venta
66265H	5,70	65	3,90	6
66210H	8,10	100	5,90	6
66215H	9,40	150	8,80	6
66220H	11,10	200	10,80	1

1/6
176 x 162 mm



Cubeta 1/6

Bac 1/6 · GN-Behälter 1/6
Container 1/6 · Caixa 1/6

Ref	€	h (mm)	L	U.Venta
66665H	3,50	65	1,00	6
66610H	3,70	100	1,60	6
66615H	5,20	150	2,20	6



Doble fondo perforado

Double fond perfore · GN Einlege-Böden, gelocht
Punched double bottom · Duplo fundo perfurado

Ref	€	Cubeta	U.Venta
66911H	9,50	1/1	10
66912H	4,90	1/2	12
66913H	2,80	1/3	12
66914H	2,10	1/4	12
66916H	1,60	1/6	12

EN

- Manufactured in polypropylene.
- Light, non-deformable and stackable.
- Airtight seal. Hygienic and easily washable.
- Suitable for refrigeration and freezing processes and food distribution (-40°C/70°C).

1/3
176 x 325 mm



Cubeta 1/3

Bac 1/3 · GN-Behälter 1/3
Container 1/3 · Caixa 1/3

Ref	€	h (mm)	L	U.Venta
66365H	4,60	65	2,40	6
66310H	5,50	100	3,80	6
66315H	6,70	150	5,10	6
66320H	8,20	200	6,90	6

1/9
176 x 108 mm



Cubeta 1/9

Bac 1/9 · GN-Behälter 1/9
Container 1/9 · Caixa 1/9

Ref	€	h (mm)	L	U.Venta
66965H	2,50	65	0,60	6
66910H	3,50	100	0,90	6

MELAMINA

Cubetas



ES

- Fabricadas en melamina de alta calidad.
- Libres de BPA.
- Ligeras, indeformables y apilables.
- Higiénicas y fácilmente lavables.
- Aptas para procesos de refrigeración, congelación o distribución de alimentos.

FR

- Fabriqué en mélamine de haute qualité.
- Sans BPA.
- Légères, indéformables et empilables.
- Hygiéniques et facilement lavables.
- Compatibles pour des processus de réfrigération, congélation ou distribution d'aliments.

EN

- Made of high quality melamine.
- BPA free.
- Light, non-deformable and stackable.
- Hygienic and easily washable.
- Suitable for refrigeration and freezing processes and food distribution

1/1
530 x 325 mm



Cubeta 1/1

Bac 1/1 · GN-Behälter 1/1
Container 1/1 · Caixa 1/1

	Ref	€	h (mm)	L	U.Venta
A	66165E	44,20	65	8,50	1
	66110E	50,30	100	13,30	1
B	66165J	47,00	65	8,50	1
	66110J	52,90	100	13,30	1

1/2
265 x 325 mm



Cubeta 1/2

Bac 1/2 · GN-Behälter 1/2
Container 1/2 · Caixa 1/2

	Ref	€	h (mm)	L	U.Venta
A	66265E	23,10	65	4,50	1
	66210E	25,60	100	8,00	1
B	66265J	24,10	65	4,50	1
	66210J	27,20	100	8,00	1

1/3
176 x 325 mm



Cubeta 1/3

Bac 1/3 · GN-Behälter 1/3
Container 1/3 · Caixa 1/3

	Ref	€	h (mm)	L	U.Venta
A	66365E	18,00	65	2,50	1
	66310E	20,00	100	3,80	1
B	66365J	19,30	65	2,50	1
	66310J	21,40	100	3,80	1

1/4
265 x 162 mm



Cubeta 1/4

Bac 1/4 · GN-Behälter 1/4
Container 1/4 · Caixa 1/4

	Ref	€	h (mm)	L	U.Venta
A	66465E	15,50	65	1,90	1
	66410E	17,40	100	2,50	1
B	66465J	16,50	65	1,90	1
	66410J	18,60	100	2,50	1

2/3
350 x 325 mm



Cubeta 2/3

Bac 2/3 · GN-Behälter 2/3
Container 2/3 · Caixa 2/3

	Ref	€	h (mm)	L	U.Venta
A	66565E	33,30	65	5,50	1
B	66565J	34,80	65	5,50	1

1/6
176 x 162 mm



Cubeta 1/6

Bac 1/6 · GN-Behälter 1/6
Container 1/6 · Caixa 1/6

	Ref	€	h (mm)	L	U.Venta
A	66665E	11,10	65	1,10	1
	66610E	12,40	100	1,60	1
B	66665J	11,80	65	1,10	1
	66610J	13,30	100	1,60	1

2/4
530 x 165 mm



Cubeta 2/4

Bac 2/4 · GN-Behälter 2/4
Container 2/4 · Caixa 2/4

	Ref	€	h (mm)	L	U.Venta
A	66765E	23,20	65	4,50	1
B	66765J	24,00	65	4,50	1

ISOTÉRMICOS

Contenedores

EPP
Expanded
Polypropilene



ES

- Fabricados en EPP. Permiten la conservación del frío y el calor: ideales para mantener la temperatura de los alimentos almacenados en el interior.
- Superficie impermeable.
- Totalmente plegables para ahorrar espacio.
- Asas en los laterales para facilitar la movilidad.
- 66064: Capacidad de 18 litros. Medidas: montada: 38x38x22 cm / plegada: 38x38x11 cm / interiores: 33,5x33,5x16 cm.
- 66066: Capacidad de 38,5 litros. Medidas: montada: 60x40x25 cm / plegada: 60x40x11 cm / interiores: 55x35x20 cm.

FR

- Fabriqué en PPE. Permet la conservation du froid et de la chaleur : idéale pour maintenir la température des aliments se trouvant à l'intérieur.
- Surface imperméable.
- Entièrement pliable pour un gain de place.
- Poignées latérales pour faciliter le transport.
- 66064 : Capacité de 18 litres. Mesures : montée : 38x38x22 cm / pliée : 38x38x11 cm / intérieurs : 33,5x33,5x16 cm.
- 66066 : Capacité de 38,5 litres. Mesures : montée : 60x40x25 cm / pliée : 60x40x11 cm / intérieurs : 55x35x20 cm.

EN

- Made of EPP. Retains both heat and cold: ideal for maintaining the temperature of food stored inside.
- Impermeable surface.
- Totally foldable to save space
- Handles on the sides for easy mobility.
- 66064: 18 litres capacity. Sizes: assembled: 38x38x22 cm / folded: 38x38x11 cm / interiors: 33,5x33,5x16 cm.
- 66066: 38,5 litres capacity. Sizes: assembled: 60x40x25 cm / folded: 60x40x11 cm / interiors: 55x35x20 cm.

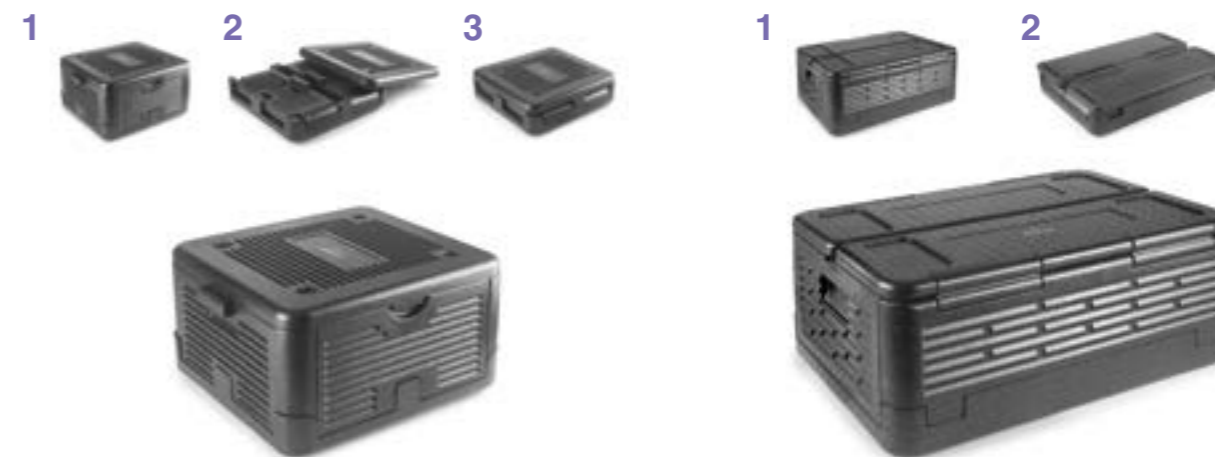

Caja isotérmica TEMPLE
PBoîte isotherme · Isothermische Box
Isothermal box · Caixa isotérmica

	Ref.	€	cm	h (cm)	L	U.Venta
A	66064	21,70	38x38	22	18,0	1
B	66066	37,20	60x40	25	38,5	1

Transporte - Estanterías
Transport - Shelves



- Diseñado para el transporte de cubetas.
- Contenedor isotérmico rígido, ligero, robusto y apilable.
- Puerta sin bisagra, sistema de cierre en la tapa.
- Ideal para transporte de alimentos en catering o cocinas.

- Conçu pour le transport de bacs.
- Conteneur isotherme rigide, léger, robuste et empilable.
- Porte sans charnière, système de verrouillage sur le couvercle.
- Idéal pour le transport des aliments de restauration ou de cuisson.

- Designed for transporting containers.
- Isothermal container rigid, lightweight, sturdy and stackable.
- Door without hinge, locking system on the lid.
- Ideal for transporting food catering or cooking.



1xGN 1/1 - 100
1xGN 2/3 - 100
1xGN1/3 - 100



2xGN 1/2 - 200
3xGN 1/3 - 200
4xGN 1/4 - 200



12xGN 1/1 - 20
6xGN 1/1 - 65
4xGN 1/1 - 100
3xGN 1/1 - 150
2xGN 1/1 - 200

Thermotrans

Thermotrans · Thermotrans
Thermotrans · Thermotrans

Ref	€	cm	U.Venta
A 66099	606,10	41x62x24	1
B 66299	649,00	41x62x37	1
C 66599	801,80	41x62x57,5	1

CARROS Colección



Tubo AISI 304 Ø25 mm. Espesor chapa 1,6 mm
Tube AISI 304 Ø 25 mm. Sheet thickness 1.6 mm



Entrega desmontado
Dismantled delivery

Carro servicio

Chariot de service · Servierwagen
Service trolley · Carro serviço

Ref	€	cm	U.Venta
66249	185,70	82x64,5x94,5	1



Entrega desmontado
Dismantled delivery

Carro servicio

Chariot de service · Servierwagen
Service trolley · Carro serviço

Ref	€	cm	U.Venta
66349	240,50	82x64,5x94,5	1



Entrega montado
Mounted delivery

Carro servicio soldado

Chariot de service · Servierwagen
Service trolley · Carro serviço soldado

Ref	€	cm	U.Venta
66350	706,70	82x64,5x94,5	1



Pestillo de bloqueo
Locking tab



Fácil de plegar
Easy to fold

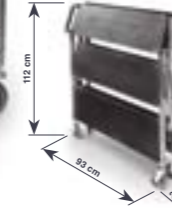

90 Kg

Carro de servicio plegable

Chariot de servie pliable · Faltbarer servierwagen
Folding service cart · Carro de serviço dobrável

Ref	€	cm	Balda	U.Venta
66247	433,80	93x51x93,5	30 kg	1



120 Kg

Entrega desmontado
Dismantled delivery

Carro servicio

Chariot de service · Servierwagen
Service trolley · Carro serviço

Ref	€	cm	U.Venta
66353	264,20	103x49x95	1

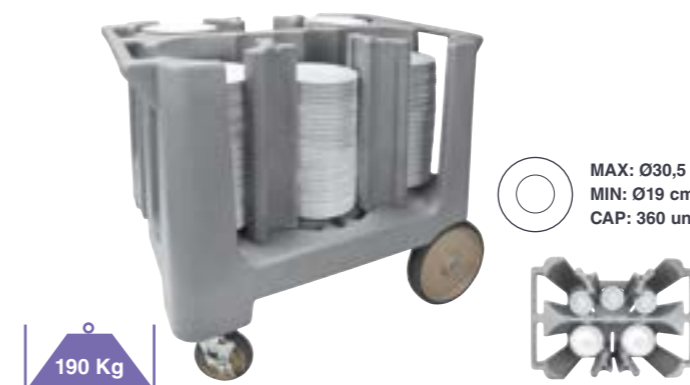

190 Kg

Carro portaplatos

Chariot porte-plateau · Tellerwagen
Dish cart · Carro porta-pratos

Ref	€	cm	h (cm)	U.Venta
66555	1.340,10	96x71	81,0	1

- Elegante diseño, perfecto para restaurantes, bares, cocinas, etc.
- Ideal para uso en interiores como exteriores.
- Construido con materiales resistentes y ligeros.
- Asas en ambos lados para facilitar su manejo.
- Ruedas giratorias multidireccionales que facilitan la movilidad en cualquier superficie.
- Dos ruedas con freno de bloqueo para mayor seguridad.
- Tres estantes que soportan 30 kg cada uno.
- Se pliega por la mitad para facilitar su almacenaje.
- Dispone de pestillo de bloqueo para mantener el carro en la posición plegada.

- Style élégant, parfait pour les restaurants, bars, cuisines, etc.
- Idéal pour une utilisation aussi bien en intérieur qu'en extérieur.
- Fabriqué avec des matériaux résistants et légers.
- Poignées des deux côtés pour faciliter sa manipulation.
- Roues pivotantes multidirectionnelles qui facilitent la mobilité sur tout type de surface.
- Deux roues avec frein de blocage pour une plus grande sécurité.
- Trois étagères qui supportent 30 kg chacune.
- Se plie en deux pour faciliter son rangement.
- Dispose d'une languette de blocage pour maintenir le chariot en position pliée.

- It has an elegant design that is perfect for restaurants, bars or kitchens, etc.
- It's perfect for indoor or outdoor use.
- It's built with strong and lightweight materials.
- It has handles on both sides for easy carrying.
- The multi-directional rotating wheels make it easy to move on any surface.
- It has two wheels with a brake for greater safety.
- It has three shelves that can hold 30 kg each.
- It folds in half for easy storage.
- It has a locking tab to keep the cart in a folded position.

Contenedor cubiertos plástico

Bac plastique pour couverts · Besteckebehälter aus Plastik
Cuttlery plastic bin · Recipiente de talheres plástico

Ref	€	cm	U.Venta
66351	39,00	33x23x18	1

Contenedor desperdicios plástico

Bac à déchets plastique · Müllbehälter aus Plastik
Rubbish plastic bin · Recipiente de desperdícios em plástico

Ref	€	cm	U.Venta
66352	65,10	33x284x56	1



Funda carro portaplatos

Housse chariot porte-plateau · Abdeckung für tellerwagen
Dish cart cover · Capa protectora carro porta-pratos

Ref	€	cm	U.Venta
62964	47,80	96x71x60	1

100
Platos
Plates

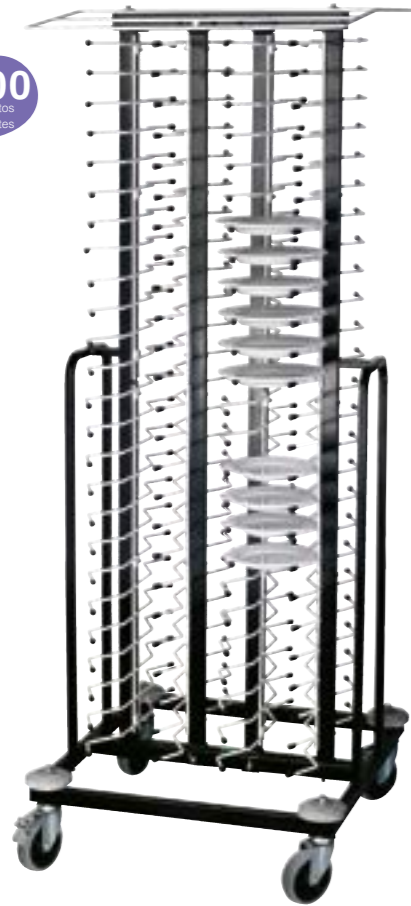

MAX: Ø28 cm
MIN: Ø8 cm
CAP: 100 units

Entrega montado
Mounted delivery

Carro portaplatos con ruedas

Hors devoirs chariot · Tellertransportwagen
Stack trolley assembled · Carro porta-pratos com rodas

Ref	€	cm	U.Venta
66550	1.693,50	70x70x195	1

Entrega desmontado
Dismantled delivery

Carro portabandejas

Chariot à glissières · Gestellwagen
Rack trolley · Carro porta-bandejas

Ref	€	Cubeta	Baldas	A (cm)	cm	U.Venta
66116	883,90	GN 1/1	17	7,5	38x55x172	1
66118	981,40	GN 2/1	17	7,5	58x69x172	1
66642	827,00	60x40	20	6,0	45x62x172	1



Inox
18/10

50 Kg
Por estante
By shelf

Ø tubo · tube: 1,7 cm
Separación entre tubos · Separation between tubes: 5 cm

Estante tubular Inox

Étagère tubulaire en Inox · Rohrgestell-Regal, Rostfrei
St. steel tubular shelf · Prateleira tubular Inóx

250 mm				400 mm				
Ref	€	L (mm)	L (mm)	Ref	€	L (mm)	L (mm)	U.Venta
56212	126,10	1200	250	56412	183,20	1200	400	1
56216	137,40	1600	250	56416	196,10	1600	400	1

AUTOSERVICIO

Bandejas



ES

- Ideal para diferentes colectivos como buffets, self-service, hospitales, colegios, guarderías, campamentos, etc.
- Compartimentos para alimentos y para cubiertos.
- Higiénicas, fáciles de recoger, limpiar y guardar; ocupan poco espacio.
- Apilables.

FR

- Idéal pour différents groupes tels que buffets, self-service, hôpitaux, écoles, crèches, camps, etc.
- Compartiments pour les aliments et pour les couverts.
- Hygiénique, faciles à collecter, nettoyer et ranger; il prend peu de place.
- Empilable.

EN

- Ideal for different groups such as buffets, self-service, hospitals, schools, nurseries, camps, etc.
- Compartments for food and for cutlery.
- Hygienic, easy to collect, clean and store; it takes up little space.
- Stackable.

La misma bandeja sirve como tapa
The same tray serves as a lid

Inox
18/10
Si
Silicone

Asas de silicona
Silicone handles



5 compartimentos
5 compartments

Bandeja autoservicio

Plateau libre-service · Selbstbedienungstablett
Self-service tray · Bandeja self-service

Ref	€	Material	cm	h (cm)	U.Venta
66957	25,70	Inox 18/10	32,5x37,5	3,6	1
66957Z	21,50	Inox	32,5x37,5	3,6	1
R66957A	0,80	Silicona	-	-	1

Set 2 asas silicona
Set 2 silicone handles

A



Tapa apta para bandejas polipropileno
Lid suitable for polypropylene trays

B



Tapa apta para bandejas policarbonato
Lid suitable for polycarbonate trays

Tapas NO compatibles con la bandejas autoservicio INOX
Lids NOT compatible with the INOX self-service trays

Tapa para bandeja autoservicio

Couvercle pour plateau self-service · Deckel für Selbstbedienung Tablett
Lid for self-service tray · Tampa para bandeja auto-serviço

Ref	€	Material	cm	U.Venta
A 66960	14,30	Polypropylene	53x37	1
B 66962	18,80	Polycarbonate	53x37	1



5 compartimentos
5 compartments

Bandeja autoservicio

Plateau self-service · Selbstbedienung Tablett
Self-service tray · Bandeja auto-serviço

Ref	€	Material	cm	U.Venta
A 66952	19,50	Polycarbonate	33x33	1
B 66951	11,90	Polypropylene	33x33	1
C 66961	19,80	Polycarbonate	33x33	1



Bandeja servicio

Plateau rectangulaire · Tablett, rechteckig
Rectangular tray · Bandeja de servir

Ref	€	cm	U.Venta
66953	17,40	53x37	1

ISOTÉRMICAS

Bandejas

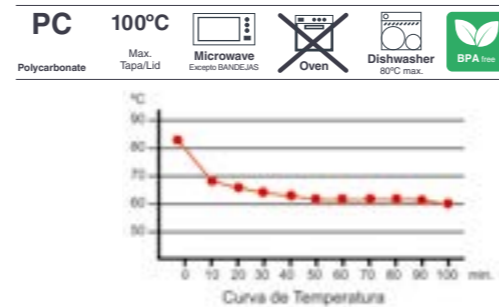

COMPOSICIÓN:
 66930 - Bandeja isotérmica B-1
 66933 - Plato llano con tapa
 66934 - Plato hondo con tapa
 66937 - Bol con tapa
 66959 - Bol rectangular con tapa
 66956 - Cierre portafichas hermético



Set completo bandeja isotérmica B-1
 Set complet B-1 · Komplet-Set B-1
 Complete set B-1 · Conjunto completo bandeja isotérmica B-1

Ref	€	cm	U.Venta
66942	239,60	53x36,5	1



Bandeja isotérmica B-1
 Plateau Isotherme B-1 · Isothermal Schale/Tablett B-1
 Isothermal B-1, Tray · Bandeja isotérmica B-1

Ref	€	cm	U.Venta
66930	206,30	53x36,5	1



Plato llano policarbonato con tapa
 Assiette plate polycarbonate avec couvercle · Grosser Teller, Polycarbonat mit deckel
 Polycarbonate dinneer plate with lid · Prato raso policarbonato com tampa

Ref	€	cm	U.Venta
66933	15,40	Ø22x3	1
66933C	10,90	-	1
66940	4,60	-	12



Plato hondo policarbonato con tapa
 Assiette creuse polycarbonate a/couvercle · Suppenteller, Polycarbonat mit deckel
 Polycarbonate sopper plate with lid · Prato fundo policarbonato com tampa

Ref	€	cm	ml	U.Venta
66934	10,10	Ø19x5	450	1
66934C	5,70	-	450	1
66939	4,40	-	-	1



Bol policarbonato con tapa
 Bol polycarbonate avec couvercle · Schüssel, Polycarbonat mit deckel
 Polycarbonate bowl with lid · Tijela policarbonato com tampa

Ref	€	cm	ml	U.Venta
66937	6,60	Ø13x6,5	450	1
66937C	5,10	-	450	1
66938	1,50	-	-	1



Bol doble pared policarbonato con tapa
 Bol isotherme polycarb. a/couvercle · Polycarbonat Schüssel, Isothermal mit Deckel
 Double wall polycarbonate bowl w/lid · Tijela parede dupla policarbonato c/ tampa

Ref	€	Ø (cm)	ml	U.Venta
66948	13,90	12,5x7	500	1
66948S	12,50	12,5x7	500	1
66938	1,50	12,5	-	1



Taza doble pared policarbonato con tapa
 Coupelle dessert isotherme polycarb. a/couvercle · Doppelwandiger Becher mit Deckel
 Double wall polycarbonate mug w/lid · Chávana parede duplo com tampa

Ref	€	Ø (cm)	ml	U.Venta
66949	12,50	8,5x7	250	1
66949S	11,20	8,5x7	250	1
66949T	1,30	8,5	-	1

Taza desayuno policarbonato con tapa
 Coupelle dessert polycarbonate a/couvercle · Frühstückstasse Polycarbonat m/Deckel
 Polycarbonate breakfast cup w/lid · Chávana pequeno-almoço com tampa

Ref	€	Ø (cm)	ml	U.Venta
66936	5,20	9x7	300	1
66936C	4,00	9x7	300	1
66936T	1,20	9	-	1



Bol rectangular Policarbonato con tapa
 Bac rectangulière en Polycarbonate a/couvercle · Behälter, Rechteckung mit Deckel
 Rectangular Polycarbonate bowl with lid · Caixa qrectangular policarbonato c/tampa

Ref	€	cm	ml	U.Venta
66959	8,10	9x13x4	400	1
66957S	4,90	-	-	1
66958	3,30	-	-	1



Plato desayuno policarbonato
 Assiette dessert polycarbonate · Frühstücksteller, Polycarbonat
 Polycarbonate breakfast plate · Prato de pequeno-almoço policarbonato

Ref	€	cm	U.Venta
66935	4,90	Ø18x2,5	1



Vaso policarbonato
 Verre polycarbonate · Glas, Polycarbonat
 Polycarbonate glass · Copo policarbonato

Ref	€	Ø (cm)	ml	U.Venta
66947	2,30	7x10	250	1
66932	3,20	8,3x9,5	300	12



Jarra policarbonato
 Pot verser polycarbonate · Krug, Polycarbonat
 Polycarbonate jug · Jarra policarbonato

Ref	€	L	U.Venta
66945	12,10	1,00	1
66945S	9,20	1,00	1
66945T	2,80	-	1

125°C max.



Tapa cubreplatos redondo Policarbonato
 Couvercle pour assiettes Polycarbonate · Polycarbonat Teller-Abdeckung
 Polycarbonate round plat cover · Tampa cobre-pratos redonda policarbonato

Ref	€	Ø (cm)	U.Venta
66950	12,00	25x7	1



Bol cuadrado policarbonato con tapa
 Bac carre en polycarbonate avec couvercle · Polycarbonat Behälter, Viereckung mit Deckel
 Square polycarbonate bowl with lid · Caixa quadrada policarbonato com tampa

Ref	€	cm	ml	U.Venta
66972	8,10	12x12x4,5	400	1
66972C	5,20	12x12x4,5	400	12
66975	2,90	12x12	-	1



Bol rectangular policarbonato con tapa
 Bac rectangulière en polycarbonate a/couvercle · Behälter, Rechteckung mit Deckel
 Rectangular polycarbonate bowl with lid · Caixa qrectangular policarbonato c/tampa

Ref	€	cm	ml	U.Venta
66974	10,80	17x12	600	1
66974C	6,70	17x11	600	1
66977	4,00	17x11	-	1



Cierre portafichas hermético
 Porte fiche · Halterung für Inhaltverzeichnis
 Index card fastener · Fecho para bandejas isotérmicas

Ref	€	U.Venta
66956	2,70	1

20 Bandejas Trays



Carro portabandejas
 Chariot plateau · Wagen für Schale/Tablett
 Isothermal tray trolley · Carro porta-bandejas

Ref	€	cm	U.Venta
66931	3.180,40	90x62x148	1

ESTANTERÍAS

Colección



ES

- Las estanterías modulares LACOR no precisan para su montaje/desmontaje de herramienta alguna, son fáciles de montar, robustas y ligeras.
- Construidas en materiales de alta calidad garantizan una larga duración, además de adecuarse al uso alimenticio en cámaras refrigeradas. La construcción modular permite al cliente adecuarse a la longitud y espacios disponibles, pudiendo ampliar y modificar la distribución en cualquier momento.
- Diseñadas para poder emplear cubetas GASTRONORM 2/1, 1/1 y 2/3, con dos anchuras de fondo disponibles, 560 mm y 385 mm.
- La distribución de los estantes permite el máximo aprovechamiento de la altura disponible, con un máximo de 11 estantes en altura 1750 mm y 12 estantes en altura de 2000 mm, con un peso máximo aproximado por estantería de 1.200 Kg. Con una altura útil mínima de 100 mm es especialmente recomendada para el almacenaje de medicamentos, artículos de ferretería o alimentos en conserva.
- Las distintas alturas de los estantes y su fácil montaje/desmontaje, permite que las distancias entre estantes puedan variarse a razón de 150 mm adicionales a los 100 mm iniciales (100mm/250mm/400mm/550mm)

FR

- Les étagères modulaires LACOR ne nécessitent aucun outil pour leur montage/démontage. Elles sont faciles à monter, robustes et légères.
- Elles sont construites dans des matériaux d'une grande qualité qui garantissent une longue durée de vie, et s'adaptent à une utilisation alimentaire dans les chambres froides.
- La construction modulable permet au client de les adapter à la longueur et aux espaces disponibles, avec la possibilité d'agrandir ou de modifier la distribution à tout moment.
- Conçues pour l'emploi de bacs GASTRONORM 2/1, 1/1 et 2/3, avec deux largeurs de fond disponibles, 560 mm et 385 mm L'agencement des étagères permet de profiter au maximum de la hauteur disponible, avec un nombre limite de 11 étagères en hauteur de 1750 mm et de 12 étagères en hauteur de 2000 mm, pour un poids maximum d'environ 1.200 Kg par étagère. Avec une hauteur utile minimale de 100 mm, elle est spécialement conseillée pour stocker des médicaments, des articles de quincaillerie ou des aliments en conserve.
- Les différentes hauteurs des étagères et leur facilité de montage/démontage permettent de varier la distance entre étagères de 150 mm supplémentaires par rapport aux 100 mm d'origine (100mm/250mm/400mm/550mm).

EN

- No tools are required in the assembly/disassembly of LACOR modular shelving; they are easy to assemble, robust and light.
- Built in top-quality material, they are guaranteed to be long-lasting, and also apt for storing food in refrigerators.
- Their modular construction allows the client to fit them lengthwise into the available space, being able to expand and modify their distribution at anytime.
- Designed for use with GASTRONORM 2/1, 1/1 and 2/3 trays, with two available depths, 560mm and 385mm The shelves' distribution allows for maximum use of available height, with a maximum height of 11 shelves at 1750mm and 12 shelves 2000mm, with an approximate maximum weight of 1,200kg per shelf.
- With a minimum height of 100mm, it's especially recommended for storing medicine, tools or canned foods.
- The different shelf heights and easy assembly / disassembly make it so the distances between shelves can vary by 150mm from the initial 100mm (100mm/250mm/400mm/550mm).

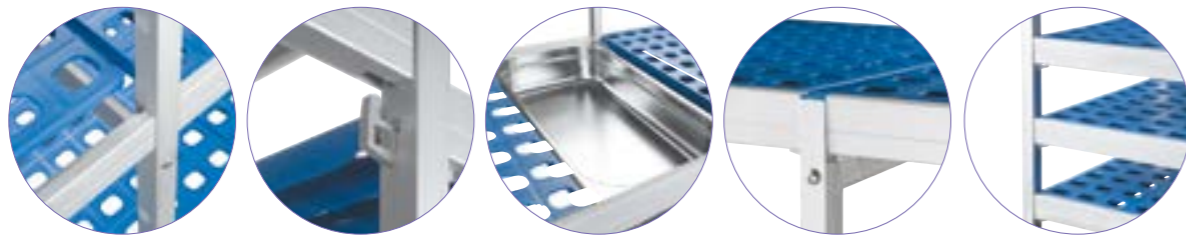

Capacidad por estante
Capacity per shelf
Distribuir el peso uniformemente
Distributing the weight evenly

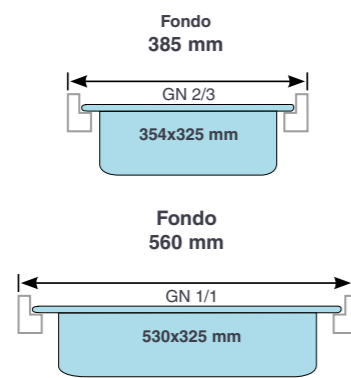
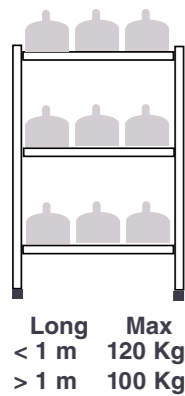

Instrucciones montaje

Las estanterías LACOR no precisan de herramienta alguna para su montaje o desmontaje; siga estas instrucciones para poder realizar el montaje de una estantería simple. En caso de precisar cualquier aclaración o información adicional, no dude en ponerse en contacto con su suministrador o visite nuestra página web.

- Extraiga todos los componentes de su embalaje original, no se deshaga de este hasta comprobar que el artículo se encuentra completo. Coloque todos los componentes en el suelo.
- Disponga de un espacio libre, ampliamente superior a las dimensiones de la estantería a montar.
- Tome un soporte lateral extendido en el suelo, introduzca 2 ganchos en los orificios más bajos que vaya a emplear, tal y como muestra la figura 1. Apoye este soporte lateral contra la pared.
- Tome el otro soporte lateral e introduzca los ganchos en los mismos orificios. Coloque ahora los 2 largueros de la parte inferior (figura 2).
- Coloque de pie este soporte lateral y aproxímese al soporte lateral apoyado contra la pared, introduzca los largueros en los ganchos de éste, la estantería quedará estabilizada (figura 3). Asegúrese de que los largueros han sido correctamente colocados.
- Ahora puede seleccionar las diferentes alturas a las cuales colocará los ganchos y largueros de los estantes (figura 4).
- Antes de colocar las parrillas plásticas, asegúrese de que todos los largueros se encuentran correctamente colocados.
- Montaje guía ángulo:
 - Retire todas las parrillas plásticas y extraiga uno de los largueros de la estantería.
 - Introduzca 2 ganchos de ángulo en la barra ángulo tal y como muestra la figura (figura 6 y 7).
NOTA: deberá emplear tantas barras ángulo como estantes disponga (figura 5).
 - Introduzca el larguero por la barra ángulo con los ganchos laterales (figura 8).
 - Ahora coloque el larguero con las barras ángulo en su anterior ubicación. Realice el mismo proceso con todos los largueros de uno de los laterales.
 - Una vez terminado, asegúrese de colocar todas las barras ángulo contra el mismo extremo, ahora realice el montaje de los 2 largueros de la parte inferior (figura 9).
 - Coloque en el nuevo soporte lateral 2 ganchos a la misma altura que la estantería ya montada.
 - Monte el nuevo soporte lateral a los largueros que forman el ángulo (figura 9); asegúrese de introducirlos correctamente.
 - Ahora ya puede montar el resto de largueros hasta finalizar el montaje.
 - Antes de colocar las parrillas plásticas, asegúrese de que todos los largueros se encuentran correctamente colocados
NOTA: las patas pueden regularse en altura 1 cm para absorber irregularidades del suelo, emplee una llave inglesa o fija de 17 mm

Mounting instructions

The LACOR shelves do not need any tool whatsoever to be assembled or dismantled. Follow these instructions to be able to assemble one single shelf. If you need any further explanation or information, do not hesitate to contact your supplier or visit our website.

- Take all the components out of their original wrapping. Do not throw the wrapping away until you have checked that the article is complete. Place all the components on the floor.
- Make a space available that is much larger than the shelf to be assembled.
- Take a side support lying on the floor and put two hooks into the lowest holes you are going to use, as shown in figure 1. Lean this support against the wall.
- Take the other side support and put the hooks into the same holes. Now place the 2 lower rods (figure 2).
- Stand this side support up and bring it next to the side support leaning against the wall. Put the rod lengths into its hooks. The shelf will remain stabilized (figure 3). Make sure the rod lengths have been properly placed.
- Now you can select the different heights at which you will place the hooks and the shelf rod lengths (figure 4).
- Before placing the plastic racks, make sure that all the rods are properly in place.
- Assembly of angle guide rail:
 - Remove all the plastic racks and take out one of the shelf rod lengths.
 - Put 2 angle hooks into the angle bar as shown (figure 6 and Figure 7).
NOTE: you must use as many angle bars as the number of shelves you have (figure 5).
 - Put the rod length through the angle bar with the side hooks (figure 8).
 - Now place the rod length with the angle bars in its previous place. Follow the same process with all the rod lengths of one of the sides.
 - Once finished, make sure you place all the angle bars against the same end. Now assemble the 2 lower rod lengths (figure 9).
 - Place 2 hooks on the new side support at the same height as the shelf assembled.
 - Mount the new side support onto the rod lengths that form the angle (figure 9). Make sure you introduce them properly.
 - Now you can assemble the rest of the rod lengths until you finish the assembly.
 - Before placing the plastic racks, make sure that all the rod lengths are properly placed.
NOTE: the legs can be adjusted by 1 cm in height to absorb unevennesses in the floor. Use an adjustable or 17 mm fixed spanner.

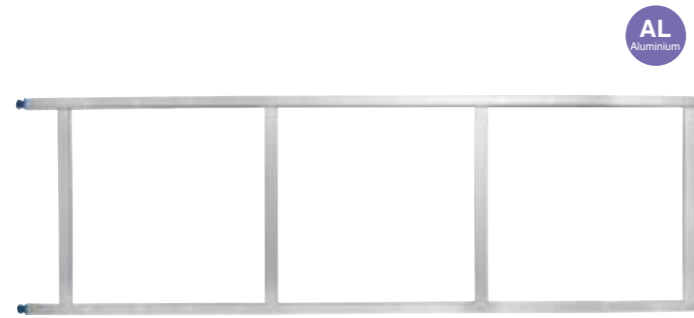

AL
Aluminium

Soporte lateral
Support latérale · Seitenständer
Lateral support · Suporte latera



PP
polypropylene

AL
Aluminium

Estantería completa
Rayonnage complet · Regale, komplett
Full shelving · Estantes completa

385 mm (GN 2/3)			560 mm (GN 1/1)		
Fondo / Width			Fondo / Width		
Ref	€	h (mm)	Ref	€	
56302	32,40	250	57302	36,40	
56317	88,70	1750	57317	96,00	10 estantes (máx) · 10 shelves (max)
56320	103,70	2000	57320	110,80	12 estantes (máx) · 12 shelves (max)

385 mm (GN 2/3)			560 mm (GN 1/1)		
Fondo / Width			Fondo / Width		
Ref	€	L (mm)	Ref	€	U.Venta
56007	46,50	710	57007	54,80	1
56008	49,40	820	57008	57,80	1
56009	54,80	930	57009	62,80	1
56010	62,80	1035	57010	74,60	1
56011	67,90	1145	57011	79,50	1
56012	72,00	1255	57012	84,70	1
56013	74,60	1365	57013	89,50	1
56014	84,70	1470	57014	98,80	1
56015	87,10	1580	57015	104,40	1



AL
Aluminium

Set ángulo 90°
Jeu angle 90° · Eckesatz 90°
90° corner set · Conjunto ángulo 90°

Ref	€	L (mm)	U.Venta
56330	15,30	385	1
57330	19,60	560	1

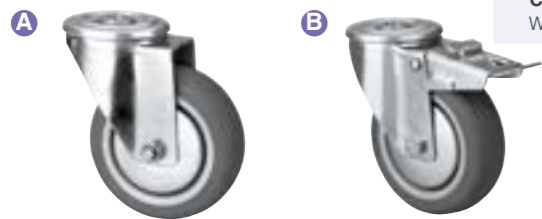

Con freno
With brake

Rueda para estantería
Roue pour étagère · Rad für Regal
Shelf wheel · Roda para prateleira

	Ref	€	U.Venta
A	56522	45,30	1
B	56523	61,50	1



Barra soporte lateral
Barre support latérale · Seitenständer stange
Lateral support bar · Barra suporte lateral

Ref	€	h (mm)	U.Venta
56502	9,10	250	1
56517	32,20	1750	1
56520	35,40	2000	1

Travesaño soporte lateral
Longeron support latérale · Seitenständer traverse
Lateral support crossbar · Travesaño soporte lateral

Ref	€	L (mm)	U.Venta
56321	5,40	385	1
57321	8,00	560	1



AL
Aluminium

Travesaño
Longeron · Traverse
Crossbar · Travesano

Ref	€	L (mm)	U.Venta
56507	14,10	654	1
56508	15,00	766	1
56509	17,20	876	1
56510	18,80	981	1
56511	20,30	1091	1
56512	21,80	1201	1
56513	23,20	1311	1
56514	24,70	1416	1
56515	25,60	1526	1



AL
Aluminium

Jgo. 4 ganchos ángulo
Jeu 4 crochet pour l'angle · 4 Satz Haken für ecke
4 pcs. set corner hooks · Jogo 4 ganchos ángulo

Ref	€	U.Venta
56527	2,40	1



AL
Aluminium

Set ángulo 90°
Jeu angle 90° · Eckesatz 90°
90° corner set · Conjunto ángulo 90°

Ref	€	L (mm)	U.Venta
56322	14,30	385	1
57322	18,50	560	1



Inox
18/10

Jgo. 6 tornillos
Jeu 6 vis en Inox · 6 Satz schrauben
6 pcs. set screws · Jogo 6 parafusos

Ref	€	U.Venta
56526	2,20	1

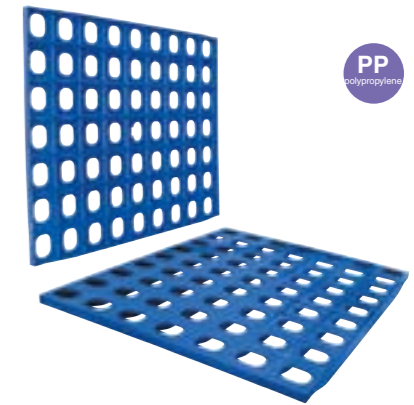

PP
polypropylene

Parrilla polietileno
Clayete en polyéthilène · Polyethylen Boden/Raster
Polyethylene rack · Grelha polietileno

Ref	€	mm	U.Venta
56325	7,20	353x325	1
56435	8,30	353x425	3
57325	11,10	530x325	1
57435	13,60	530x435	1



AL
Aluminium

Jgo. 4 ganchos travesaño
Jeu 4 crochet pour longeron · 4 Satz Haken für traverse
4 pcs. crossbar hooks · Jogo 4 ganchos travesano

Ref	€	U.Venta
56524	3,00	1



PP
polypropylene

Jgo. 2 pie nivelación
Jeu 2 pied nivellement · 2 Satz niveau füsse
26 pcs. set level foot · 2 jogo pé nivelamento

Ref	€	U.Venta
56525	4,80	1



Fondo · Width: 385 mm
 Altura · Height: 250 mm

Estantería completa

Rayonnage complet · Regale, komplett
 Full shelving · Estantes completa

1 Estante · Shelf

L (mm)	Ref	€	Desglose / Breakdown
710	55400	112,50	56302 x 2 / 56007 x 1
822	55401	115,00	56302 x 2 / 56008 x 1
932	55402	120,00	56302 x 2 / 56009 x 1
1037	55403	127,50	56302 x 2 / 56010 x 1
1147	55404	132,60	56302 x 2 / 56011 x 1
1257	55405	136,80	56302 x 2 / 56012 x 1
1367	55406	139,20	56302 x 2 / 56013 x 1
1472	55407	149,30	56302 x 2 / 56014 x 1
1582	55408	151,70	56302 x 2 / 56015 x 1

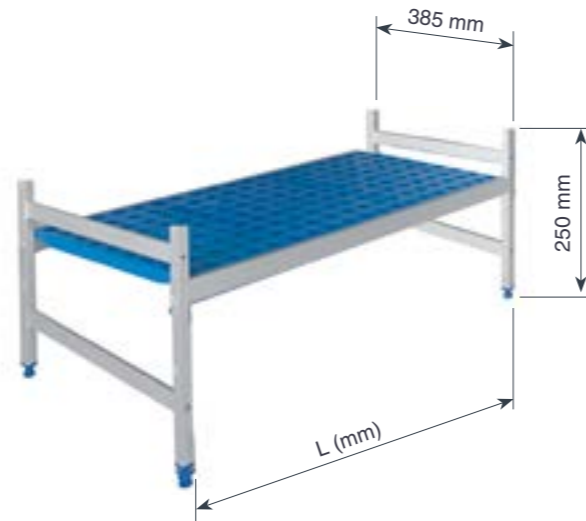

Fondo · Width: 560 mm
 Altura · Height: 250 mm

Estantería completa

Rayonnage complet · Regale, komplett
 Full shelving · Estantes completa

1 Estante · Shelf

L (mm)	Ref	€	Desglose / Breakdown
710	55700	127,90	57302 x 2 / 57007 x 1
822	55701	130,50	57302 x 2 / 57008 x 1
932	55702	135,50	57302 x 2 / 57009 x 1
1037	55703	147,30	57302 x 2 / 57010 x 1
1147	55704	152,30	57302 x 2 / 57011 x 1
1257	55705	157,40	57302 x 2 / 57012 x 1
1367	55706	162,00	57302 x 2 / 57013 x 1
1472	55707	172,10	57302 x 2 / 57014 x 1
1582	55708	176,90	57302 x 2 / 57015 x 1

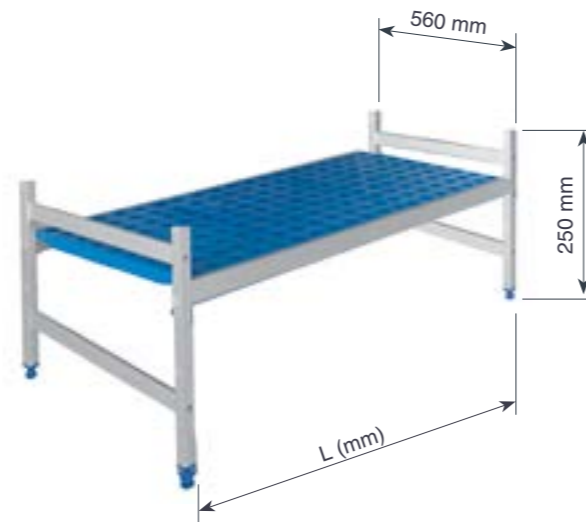

Fondo · Width: 385 mm
 Altura · Height: 1.750 mm



Estantería completa

Rayonnage complet · Regale, komplett
 Full shelving · Estantes completa

3 Estantes · Shelf

L (mm)	Ref	€	Desglose · Breakdown
710	55409	320,50	56317 x 2 + 56007 x 3
822	55410	328,30	56317 x 2 + 56008 x 3
932	55411	343,40	56317 x 2 + 56009 x 3
1037	55412	365,80	56317 x 2 + 56010 x 3
1147	55413	379,80	56317 x 2 + 56011 x 3
1257	55414	393,90	56317 x 2 + 56012 x 3
1367	55415	400,50	56317 x 2 + 56013 x 3
1472	55416	431,20	56317 x 2 + 56014 x 3
1582	55417	437,50	56317 x 2 + 56015 x 3

4 Estantes · Shelf

Ref	€	Desglose · Breakdown
55446	367,40	56317 x 2 + 56007 x 4
55447	378,80	56317 x 2 + 56008 x 4
55448	397,50	56317 x 2 + 56009 x 4
55449	427,90	56317 x 2 + 56010 x 4
55450	448,30	56317 x 2 + 56011 x 4
55451	465,90	56317 x 2 + 56012 x 4
55452	475,80	56317 x 2 + 56013 x 4
55453	515,80	56317 x 2 + 56014 x 4
55454	525,80	56317 x 2 + 56015 x 4

5 Estantes · Shelf

Ref	€	Desglose · Breakdown
55483	415,50	56317 x 2 + 56007 x 5
55484	427,90	56317 x 2 + 56008 x 5
55485	453,70	56317 x 2 + 56009 x 5
55486	491,40	56317 x 2 + 56010 x 5
55487	516,80	56317 x 2 + 56011 x 5
55488	538,10	56317 x 2 + 56012 x 5
55489	539,60	56317 x 2 + 56013 x 5
55490	588,70	56317 x 2 + 56014 x 5
55491	600,90	56317 x 2 + 56015 x 5

SIMPLE

DOBLE · DOUBLE

TRIPLE

L (mm)	Ref	€	Desglose · Breakdown
1719	55418	597,80	56317 x 3 + 56007 x 3 + 56010 x 3
1829	55419	613,10	56317 x 3 + 56007 x 3 + 56011 x 3
1939	55420	625,80	56317 x 3 + 56007 x 3 + 56012 x 3
2046	55421	643,30	56317 x 2 + 56010 x 6
2154	55422	663,30	56317 x 3 + 56007 x 3 + 56014 x 3
2264	55423	670,80	56317 x 3 + 56007 x 3 + 56015 x 3
2376	55424	678,30	56317 x 3 + 56010 x 3 + 56013 x 3
2481	55425	708,50	56317 x 3 + 56010 x 3 + 56014 x 3
2591	55426	715,90	56317 x 3 + 56010 x 3 + 56015 x 3
2701	55427	731,00	56317 x 3 + 56011 x 3 + 56015 x 3
2811	55428	743,80	56317 x 3 + 56013 x 3 + 56014 x 3
2916	55429	773,30	56317 x 2 + 56014 x 6
3026	55430	780,20	56317 x 3 + 56014 x 3 + 56015 x 3
3136	55431	788,60	56317 x 3 + 56015 x 6

Ref	€	Desglose · Breakdown
55455	708,40	56317 x 3 + 56007 x 4 + 56010 x 4
55456	728,00	56317 x 3 + 56007 x 4 + 56011 x 4
55457	744,70	56317 x 3 + 56007 x 4 + 56012 x 4
55458	768,60	56317 x 3 + 56010 x 8
55459	795,50	56317 x 3 + 56007 x 4 + 56014 x 4
55460	804,80	56317 x 3 + 56007 x 4 + 56015 x 4
55461	815,60	56317 x 3 + 56010 x 4 + 56013 x 4
55462	855,90	56317 x 3 + 56010 x 4 + 56014 x 4
55463	865,20	56317 x 3 + 56010 x 4 + 56015 x 4
55464	886,00	56317 x 3 + 56011 x 4 + 56015 x 4
55465	903,00	56317 x 3 + 56013 x 4 + 56014 x 4
55466	943,00	56317 x 3 + 56014 x 8
55467	952,80	56317 x 3 + 56014 x 4 + 56015 x 4
55468	963,00	56317 x 3 + 56015 x 8

Ref	€	Desglose · Breakdown
55492	818,80	56317 x 3 + 56007 x 5 + 56010 x 5
55493	844,20	56317 x 3 + 56007 x 5 + 56011 x 5
55494	865,30	56317 x 3 + 56007 x 5 + 56012 x 5
55495	894,30	56317 x 3 + 56010 x 10
55496	927,70	56317 x 3 + 56007 x 5 + 56014 x 5
55497	940,10	56317 x 3 + 56007 x 5 + 56015 x 5
55498	953,10	56317 x 3 + 56010 x 5 + 56013 x 5
55499	1.003,30	56317 x 3 + 56010 x 5 + 56014 x 5
55500	1.015,70	56317 x 3 + 56010 x 5 + 56015 x 5
55501	1.040,90	56317 x 3 + 56011 x 5 + 56015 x 5
55502	1.062,10	56317 x 3 + 56013 x 5 + 56014 x 5
55503	1.112,00	56317 x 3 + 56014 x 10
55504	1.124,50	56317 x 3 + 56014 x 5 + 56015 x 5
55505	1.136,90	56317 x 3 + 56015 x 10

L (mm)	Ref	€	Desglose · Breakdown
3275	55432	947,90	56317 x 4 + 56010 x 6 + 56012 x 3
3385	55433	955,40	56317 x 4 + 56010 x 6 + 56013 x 3
3490	55434	985,50	56317 x 4 + 56010 x 6 + 56014 x 3
3598	55435	1.005,60	56317 x 4 + 56007 x 3 + 56014 x 6
3710	55436	1.016,00	56317 x 4 + 56011 x 6 + 56014 x 3
3818	55437	1.020,40	56317 x 4 + 56007 x 3 + 56015 x 6
3925	55438	1.050,90	56317 x 4 + 56010 x 3 + 56014 x 6
4035	55439	1.066,20	56317 x 4 + 56011 x 3 + 56014 x 6
4145	55440	1.069,90	56317 x 4 + 56010 x 3 + 56015 x 6
4255	55441	1.080,90	56317 x 4 + 56011 x 3 + 56015 x 6
4360	55442	1.116,40	56317 x 4 + 56014 x 9
4470	55443	1.123,80	56317 x 4 + 56014 x 6 + 56015 x 3
4580	55444	1.131,00	56317 x 4 + 56014 x 3 + 56015 x 6
4690	55445	1.138,60	56317 x 4 + 56015 x 9

Ref	€	Desglose · Breakdown
55469	1.145,90	56317 x 4 + 56010 x 8 + 56012 x 4
55470	1.155,80	56317 x 4 + 56010 x 8 + 56013 x 4
55471	1.195,80	56317 x 4 + 56010 x 8 + 56014 x 4
55472	1.222,50	56317 x 4 + 56007 x 4 + 56014 x 8
55473	1.236,20	56317 x 4 + 56011 x 8 + 56014 x 4
55474	1.242,30	56317 x 4 + 56007 x 4 + 56015 x 8
55475	1.283,20	56317 x 4 + 56010 x 4 + 56014 x 8
55476	1.309,60	56317 x 4 + 56011 x 4 + 56014 x 8
55477	1.316,20	56317 x 4 + 56010 x 4 + 56015 x 8
55478	1.323,10	56317 x 4 + 56011 x 4 + 56015 x 8
55479	1.370,10	56317 x 4 + 56014 x 12
55480	1.380,00	56317 x 4 + 56014 x 8 + 56015 x 4
55481	1.389,90	56317 x 4 + 56014 x 4 + 56015 x 8
55482	1.399,70	56317 x 4 + 56015 x 12

Ref	€	Desglose · Breakdown
55506	1.343,50	56317 x 4 + 56010 x 10 + 56012 x 5
55507	1.356,00	56317 x 4 + 56010 x 10 + 56013 x 5
55508	1.405,90	56317 x 4 + 56010 x 10 + 56014 x 5
55509	1.439,70	56317 x 4 + 56007 x 5 + 56014 x 10
55510	1.456,60	56317 x 4 + 56011 x 10 + 56014 x 5
55511	1.464,10	56317 x 4 + 56007 x 5 + 56015 x 10
55512	1.515,00	56317 x 4 + 56010 x 5 + 56014 x 10
55513	1.540,30	56317 x 4 + 56011 x 5 + 56014 x 10
55514	1.549,40	56317 x 4 + 56010 x 5 + 56015 x 10
55515	1.565,00	56317 x 4 + 56011 x 5 + 56015 x 10
55516	1.624,00	56317 x 4 + 56014 x 15
55517	1.636,40	56317 x 4 + 56014 x 10 + 56015 x 5
55518	1.648,90	56317 x 4 + 56014 x 5 + 56015 x 10
55519	1.661,20	56317 x 4 + 56015 x 15



Fondo · Width: 385 mm
 Altura · Height: 2.000 mm



Estantería completa
 Rayonnage complet · Regale, komplett
 Full shelving · Estantes completa

3 Estantes · Shelf

L (mm)	Ref	€	Desglose · Breakdown
710	55520	350,40	56320 x 2 + 56007 x 3
822	55521	357,90	56320 x 2 + 56008 x 3
932	55522	371,60	56320 x 2 + 56009 x 3
1037	55523	394,80	56320 x 2 + 56010 x 3
1147	55524	410,60	56320 x 2 + 56011 x 3
1257	55525	423,50	56320 x 2 + 56012 x 3
1367	55526	430,80	56320 x 2 + 56013 x 3
1472	55527	460,80	56320 x 2 + 56014 x 3
1582	55528	468,20	56320 x 2 + 56015 x 3

4 Estantes · Shelf

Ref	€	Desglose · Breakdown
55557	397,90	56320 x 2 + 56007 x 4
55558	408,30	56320 x 2 + 56008 x 4
55559	428,20	56320 x 2 + 56009 x 4
55560	458,20	56320 x 2 + 56010 x 4
55561	478,60	56320 x 2 + 56011 x 4
55562	495,40	56320 x 2 + 56012 x 4
55563	505,50	56320 x 2 + 56013 x 4
55564	545,50	56320 x 2 + 56014 x 4
55565	555,20	56320 x 2 + 56015 x 4

5 Estantes · Shelf

Ref	€	Desglose · Breakdown
55594	445,60	56320 x 2 + 56007 x 5
55595	458,60	56320 x 2 + 56008 x 5
55596	483,40	56320 x 2 + 56009 x 5
55597	520,90	56320 x 2 + 56010 x 5
55598	546,50	56320 x 2 + 56011 x 5
55599	567,60	56320 x 2 + 56012 x 5
55600	580,00	56320 x 2 + 56013 x 5
55601	630,00	56320 x 2 + 56014 x 5
55602	642,40	56320 x 2 + 56015 x 5

SIMPLE

DOBLE · DOUBLE

TRIPLE

L (mm)	Ref	€	Desglose · Breakdown
1719	55529	641,90	56320 x 3 + 56007 x 3 + 56010 x 3
1829	55530	657,50	56320 x 3 + 56007 x 3 + 56011 x 3
1939	55531	670,30	56320 x 3 + 56007 x 3 + 56012 x 3
2046	55532	687,30	56320 x 2 + 56010 x 6
2154	55533	707,60	56320 x 3 + 56007 x 3 + 56014 x 3
2264	55534	714,90	56320 x 3 + 56007 x 3 + 56015 x 3
2376	55535	722,80	56320 x 3 + 56010 x 3 + 56013 x 3
2481	55536	752,80	56320 x 3 + 56010 x 3 + 56014 x 3
2591	55537	760,10	56320 x 3 + 56010 x 3 + 56015 x 3
2701	55538	775,50	56320 x 3 + 56011 x 3 + 56015 x 3
2811	55539	787,10	56320 x 3 + 56013 x 3 + 56014 x 3
2916	55540	817,30	56320 x 2 + 56014 x 6
3026	55541	825,70	56320 x 3 + 56014 x 3 + 56015 x 3
3136	55542	833,00	56320 x 3 + 56015 x 6

Ref	€	Desglose · Breakdown
55566	752,70	56320 x 3 + 56007 x 4 + 56010 x 4
55567	772,10	56320 x 3 + 56007 x 4 + 56011 x 4
55568	790,00	56320 x 3 + 56007 x 4 + 56012 x 4
55569	813,10	56320 x 3 + 56010 x 8
55570	839,90	56320 x 3 + 56007 x 4 + 56014 x 4
55571	848,90	56320 x 3 + 56007 x 4 + 56015 x 4
55572	859,80	56320 x 3 + 56010 x 4 + 56013 x 4
55573	900,30	56320 x 3 + 56010 x 4 + 56014 x 4
55574	910,00	56320 x 3 + 56010 x 4 + 56015 x 4
55575	930,50	56320 x 3 + 56011 x 4 + 56015 x 4
55576	947,30	56320 x 3 + 56013 x 4 + 56014 x 4
55577	987,30	56320 x 3 + 56014 x 8
55578	997,40	56320 x 3 + 56014 x 4 + 56015 x 4
55579	1.007,10	56320 x 3 + 56015 x 8

Ref	€	Desglose · Breakdown
55603	863,20	56320 x 3 + 56007 x 5 + 56010 x 5
55604	888,50	56320 x 3 + 56007 x 5 + 56011 x 5
55605	909,80	56320 x 3 + 56007 x 5 + 56012 x 5
55606	938,70	56320 x 3 + 56010 x 10
55607	972,20	56320 x 3 + 56007 x 5 + 56014 x 5
55608	984,50	56320 x 3 + 56007 x 5 + 56015 x 5
55609	997,60	56320 x 3 + 56010 x 5 + 56013 x 5
55610	1.047,70	56320 x 3 + 56010 x 5 + 56014 x 5
55611	1.060,00	56320 x 3 + 56010 x 5 + 56015 x 5
55612	1.085,30	56320 x 3 + 56011 x 5 + 56015 x 5
55613	1.106,60	56320 x 3 + 56013 x 5 + 56014 x 5
55614	1.156,70	56320 x 3 + 56014 x 10
55615	1.169,10	56320 x 3 + 56014 x 5 + 56015 x 5
55616	1.181,20	56320 x 3 + 56015 x 10

L (mm)	Ref	€	Desglose · Breakdown
3275	55543	1.007,20	56320 x 4 + 56010 x 6 + 56012 x 3
3385	55544	1.014,70	56320 x 4 + 56010 x 6 + 56013 x 3
3490	55545	1.044,80	56320 x 4 + 56010 x 6 + 56014 x 3
3598	55546	1.065,00	56320 x 4 + 56007 x 3 + 56014 x 6
3710	55547	1.075,20	56320 x 4 + 56011 x 6 + 56014 x 3
3818	55548	1.079,60	56320 x 4 + 56007 x 3 + 56015 x 6
3925	55549	1.110,30	56320 x 4 + 56010 x 3 + 56014 x 6
4035	55550	1.125,20	56320 x 4 + 56011 x 3 + 56014 x 6
4145	55551	1.124,80	56320 x 4 + 56010 x 3 + 56015 x 6
4255	55552	1.140,20	56320 x 4 + 56011 x 3 + 56015 x 6
4360	55553	1.175,60	56320 x 4 + 56014 x 6
4470	55554	1.183,10	56320 x 4 + 56014 x 6 + 56015 x 3
4580	55555	1.190,40	56320 x 4 + 56014 x 3 + 56015 x 6
4690	55556	1.197,80	56320 x 4 + 56015 x 9

Ref	€	Desglose · Breakdown
55580	1.205,10	56320 x 4 + 56010 x 8 + 56012 x 4
55581	1.215,00	56320 x 4 + 56010 x 8 + 56013 x 4
55582	1.255,00	56320 x 4 + 56010 x 8 + 56014 x 4
55583	1.281,70	56320 x 4 + 56007 x 4 + 56014 x 8
55584	1.295,60	56320 x 4 + 56011 x 8 + 56014 x 4
55585	1.301,60	56320 x 4 + 56007 x 4 + 56015 x 8
55586	1.342,30	56320 x 4 + 56010 x 4 + 56014 x 8
55587	1.362,50	56320 x 4 + 56011 x 4 + 56014 x 8
55588	1.362,10	56320 x 4 + 56010 x 4 + 56015 x 8
55589	1.382,20	56320 x 4 + 56011 x 4 + 56015 x 8
55590	1.428,90	56320 x 4 + 56014 x 12
55591	1.438,40	56320 x 4 + 56014 x 8 + 56015 x 4
55592	1.449,20	56320 x 4 + 56014 x 4 + 56015 x 8
55593	1.459,10	56320 x 4 + 56015 x 12

Ref	€	Desglose · Breakdown
55617	1.402,80	56320 x 4 + 56010 x 10 + 56012 x 5
55618	1.415,20	56320 x 4 + 56010 x 10 + 56013 x 5
55619	1.465,30	56320 x 4 + 56010 x 10 + 56014 x 5
55620	1.498,80	56320 x 4 + 56007 x 5 + 56014 x 10
55621	1.516,00	56320 x 4 + 56011 x 10 + 56014 x 5
55622	1.523,40	56320 x 4 + 56007 x 5 + 56015 x 10
55623	1.574,10	56320 x 4 + 56010 x 5 + 56014 x 10
55624	1.599,50	56320 x 4 + 56011 x 5 + 56014 x 10
55625	1.598,90	56320 x 4 + 56010 x 5 + 56015 x 10
55626	1.624,20	56320 x 4 + 56011 x 5 + 56015 x 10
55627	1.683,20	56320 x 4 + 56014 x 15
55628	1.695,60	56320 x 4 + 56014 x 10 + 56015 x 5
55629	1.708,00	56320 x 4 + 56014 x 5 + 56015 x 10
55630	1.720,20	56320 x 4 + 56015 x 15



Fondo · Width: 560 mm
 Altura · Height: 1.750 mm



Estantería completa
 Rayonnage complet · Regale, komplett
 Full shelving · Estantes completa

3 Estantes · Shelf

L (mm)	Ref	€	Desglose · Breakdown
710	55709	357,90	57317 x 2 + 57007 x 3
822	55710	365,50	57317 x 2 + 57008 x 3
932	55711	379,80	57317 x 2 + 57009 x 3
1037	55712	415,50	57317 x 2 + 57010 x 3
1147	55713	431,20	57317 x 2 + 57011 x 3
1257	55714	446,00	57317 x 2 + 57012 x 3
1367	55715	460,80	57317 x 2 + 57013 x 3
1472	55716	490,90	57317 x 2 + 57014 x 3
1582	55717	505,70	57317 x 2 + 57015 x 3

4 Estantes · Shelf

Ref	€	Desglose · Breakdown
55746	412,70	57317 x 2 + 57007 x 4
55747	422,20	57317 x 2 + 57008 x 4
55748	443,00	57317 x 2 + 57009 x 4
55749	490,70	57317 x 2 + 57010 x 4
55750	511,00	57317 x 2 + 57011 x 4
55751	530,70	57317 x 2 + 57012 x 4
55752	550,50	57317 x 2 + 57013 x 4
55753	590,30	57317 x 2 + 57014 x 4
55754	610,10	57317 x 2 + 57015 x 4

5 Estantes · Shelf

Ref	€	Desglose · Breakdown
55783	468,60	57317 x 2 + 57007 x 5
55784	480,90	57317 x 2 + 57008 x 5
55785	506,30	57317 x 2 + 57009 x 5
55786	565,20	57317 x 2 + 57010 x 5
55787	590,50	57317 x 2 + 57011 x 5
55788	615,20	57317 x 2 + 57012 x 5
55789	639,90	57317 x 2 + 57013 x 5
55790	690,10	57317 x 2 + 57014 x 5
55791	714,40	57317 x 2 + 57015 x 5

SIMPLE

DOBLE · DOUBLE

TRIPLE

L (mm)	Ref	€	Desglose · Breakdown
1719	55718	677,90	57317 x 3 + 57007 x 3 + 57010 x 3
1829	55719	693,10	57317 x 3 + 57007 x 3 + 57011 x 3
1939	55720	707,60	57317 x 3 + 57007 x 3 + 57012 x 3
2046	55721	735,00	57317 x 3 + 57010 x 6
2154	55722	752,80	57317 x 3 + 57007 x 3 + 57014 x 3
2264	55723	766,40	57317 x 3 + 57007 x 3 + 57015 x 3
2376	55724	780,80	57317 x 3 + 57010 x 3 + 57013 x 3
2481	55725	810,40	57317 x 3 + 57010 x 3 + 57014 x 3
2591	55726	825,70	57317 x 3 + 57010 x 3 + 57015 x 3
2701	55727	840,50	57317 x 3 + 57011 x 3 + 57015 x 3
2811	55728	855,70	57317 x 3 + 57013 x 3 + 57014 x 3
2916	55729	885,60	57317 x 3 + 57014 x 6
3026	55730	900,50	57317 x 3 + 57014 x 3 + 57015 x 3
3136	55731	915,30	57317 x 3 + 57015 x 6

Ref	€	Desglose · Breakdown
55755	807,80	57317 x 3 + 57007 x 4 + 57010 x 4
55756	827,90	57317 x 3 + 57007 x 4 + 57011 x 4
55757	847,30	57317 x 3 + 57007 x 4 + 57012 x 4
55758	885,20	57317 x 3 + 57010 x 8
55759	907,70	57317 x 3 + 57007 x 4 + 57014 x 4
55760	927,40	57317 x 3 + 57007 x 4 + 57015 x 4
55761	945,10	57317 x 3 + 57010 x 4 + 57013 x 4
55762	985,00	57317 x 3 + 57010 x 4 + 57014 x 4
55763	1.004,70	57317 x 3 + 57010 x 4 + 57015 x 4
55764	1.024,90	57317 x 3 + 57011 x 4 + 57015 x 4
55765	1.044,80	57317 x 3 + 57013 x 4 + 57014 x 4
55766	1.084,70	57317 x 3 + 57014 x 8
55767	1.104,60	57317 x 3 + 57014 x 4 + 57015 x 4
55768	1.124,20	57317 x 3 + 57015 x 8

Ref	€	Desglose · Breakdown
55792	937,80</	



Fondo · Width: 560 mm
Altura · Height: 2.000 mm



Estantería completa

Rayonnage complet · Regale, komplett
Full shelving · Estantes completa

3 Estantes · Shelf

L (mm)	Ref	€	Desglose · Breakdown
710	55820	387,80	57320 x 2 + 57007 x 3
822	55821	394,80	57320 x 2 + 57008 x 3
932	55822	410,30	57320 x 2 + 57009 x 3
1037	55823	445,60	57320 x 2 + 57010 x 3
1147	55824	460,80	57320 x 2 + 57011 x 3
1257	55825	475,70	57320 x 2 + 57012 x 3
1367	55826	490,50	57320 x 2 + 57013 x 3
1472	55827	520,50	57320 x 2 + 57014 x 3
1582	55828	535,40	57320 x 2 + 57015 x 3

4 Estantes · Shelf

Ref	€	Desglose · Breakdown
55857	443,00	57320 x 2 + 57007 x 4
55858	452,80	57320 x 2 + 57008 x 4
55859	472,90	57320 x 2 + 57009 x 4
55860	520,20	57320 x 2 + 57010 x 4
55861	540,50	57320 x 2 + 57011 x 4
55862	560,50	57320 x 2 + 57012 x 4
55863	580,00	57320 x 2 + 57013 x 4
55864	620,10	57320 x 2 + 57014 x 4
55865	639,80	57320 x 2 + 57015 x 4

5 Estantes · Shelf

Ref	€	Desglose · Breakdown
55894	498,10	57320 x 2 + 57007 x 5
55895	510,60	57320 x 2 + 57008 x 5
55896	535,80	57320 x 2 + 57009 x 5
55897	594,80	57320 x 2 + 57010 x 5
55898	620,20	57320 x 2 + 57011 x 5
55899	644,90	57320 x 2 + 57012 x 5
55900	669,70	57320 x 2 + 57013 x 5
55901	718,50	57320 x 2 + 57014 x 5
55902	743,10	57320 x 2 + 57015 x 5

L (mm)	Ref	€	Desglose · Breakdown
1719	55829	721,40	57320 x 3 + 57007 x 3 + 57010 x 3
1829	55830	737,60	57320 x 3 + 57007 x 3 + 57011 x 3
1939	55831	751,40	57320 x 3 + 57007 x 3 + 57012 x 3
2046	55832	780,30	57320 x 3 + 57010 x 6
2154	55833	797,30	57320 x 3 + 57007 x 3 + 57014 x 3
2264	55834	811,70	57320 x 3 + 57007 x 3 + 57015 x 3
2376	55835	824,00	57320 x 3 + 57010 x 3 + 57013 x 3
2481	55836	854,20	57320 x 3 + 57010 x 3 + 57014 x 3
2591	55837	870,10	57320 x 3 + 57010 x 3 + 57015 x 3
2701	55838	885,30	57320 x 3 + 57011 x 3 + 57015 x 3
2811	55839	900,10	57320 x 3 + 57013 x 3 + 57014 x 3
2916	55840	930,10	57320 x 3 + 57014 x 6
3026	55841	945,10	57320 x 3 + 57014 x 3 + 57015 x 3
3136	55842	959,70	57320 x 3 + 57015 x 6

Ref	€	Desglose · Breakdown
55866	852,20	57320 x 3 + 57007 x 4 + 57010 x 4
55867	872,10	57320 x 3 + 57007 x 4 + 57011 x 4
55868	891,30	57320 x 3 + 57007 x 4 + 57012 x 4
55869	929,50	57320 x 3 + 57010 x 8
55870	952,00	57320 x 3 + 57007 x 4 + 57014 x 4
55871	971,90	57320 x 3 + 57007 x 4 + 57015 x 4
55872	989,40	57320 x 3 + 57010 x 4 + 57013 x 4
55873	1.029,50	57320 x 3 + 57010 x 4 + 57014 x 4
55874	1.049,20	57320 x 3 + 57010 x 4 + 57015 x 4
55875	1.069,40	57320 x 3 + 57011 x 4 + 57015 x 4
55876	1.089,30	57320 x 3 + 57013 x 4 + 57014 x 4
55877	1.129,20	57320 x 3 + 57014 x 8
55878	1.149,00	57320 x 3 + 57014 x 4 + 57015 x 4
55879	1.168,90	57320 x 3 + 57015 x 8

Ref	€	Desglose · Breakdown
55903	982,40	57320 x 3 + 57007 x 5 + 57010 x 5
55904	1.007,30	57320 x 3 + 57007 x 5 + 57011 x 5
55905	1.032,10	57320 x 3 + 57007 x 5 + 57012 x 5
55906	1.078,80	57320 x 3 + 57010 x 10
55907	1.106,80	57320 x 3 + 57007 x 5 + 57014 x 5
55908	1.131,60	57320 x 3 + 57007 x 5 + 57015 x 5
55909	1.153,40	57320 x 3 + 57010 x 5 + 57013 x 5
55910	1.203,50	57320 x 3 + 57010 x 5 + 57014 x 5
55911	1.228,40	57320 x 3 + 57010 x 5 + 57015 x 5
55912	1.253,50	57320 x 3 + 57011 x 5 + 57015 x 5
55913	1.278,40	57320 x 3 + 57013 x 5 + 57014 x 5
55914	1.328,60	57320 x 3 + 57014 x 10
55915	1.353,00	57320 x 3 + 57014 x 5 + 57015 x 5
55916	1.377,60	57320 x 3 + 57015 x 10

L (mm)	Ref	€	Desglose · Breakdown
3275	55843	1.145,20	57320 x 4 + 57010 x 6 + 57012 x 3
3385	55844	1.159,90	57320 x 4 + 57010 x 6 + 57013 x 3
3490	55845	1.190,00	57320 x 4 + 57010 x 6 + 57014 x 3
3598	55846	1.206,80	57320 x 4 + 57007 x 3 + 57014 x 6
3710	55847	1.220,50	57320 x 4 + 57011 x 6 + 57014 x 3
3818	55848	1.236,60	57320 x 4 + 57007 x 3 + 57015 x 6
3925	55849	1.265,00	57320 x 4 + 57010 x 3 + 57014 x 6
4035	55850	1.280,00	57320 x 4 + 57011 x 3 + 57014 x 6
4145	55851	1.294,30	57320 x 4 + 57010 x 3 + 57015 x 6
4255	55852	1.309,90	57320 x 4 + 57011 x 3 + 57015 x 6
4360	55853	1.339,70	57320 x 4 + 57014 x 9
4470	55854	1.354,50	57320 x 4 + 57014 x 6 + 57015 x 3
4580	55855	1.369,40	57320 x 4 + 57014 x 3 + 57015 x 6
4690	55856	1.384,30	57320 x 4 + 57015 x 9

Ref	€	Desglose · Breakdown
55880	1.379,00	57320 x 4 + 57010 x 8 + 57012 x 4
55881	1.398,70	57320 x 4 + 57010 x 8 + 57013 x 4
55882	1.438,70	57320 x 4 + 57010 x 8 + 57014 x 4
55883	1.460,40	57320 x 4 + 57007 x 4 + 57014 x 8
55884	1.479,40	57320 x 4 + 57011 x 8 + 57014 x 4
55885	1.500,00	57320 x 4 + 57007 x 4 + 57015 x 8
55886	1.538,50	57320 x 4 + 57010 x 4 + 57014 x 8
55887	1.559,00	57320 x 4 + 57011 x 4 + 57014 x 8
55888	1.578,10	57320 x 4 + 57010 x 4 + 57015 x 8
55889	1.597,60	57320 x 4 + 57011 x 4 + 57015 x 8
55890	1.638,20	57320 x 4 + 57014 x 12
55891	1.658,10	57320 x 4 + 57014 x 8 + 57015 x 4
55892	1.676,90	57320 x 4 + 57014 x 4 + 57015 x 8
55893	1.697,60	57320 x 4 + 57015 x 12

Ref	€	Desglose · Breakdown
55917	1.612,60	57320 x 4 + 57010 x 10 + 57012 x 5
55918	1.637,30	57320 x 4 + 57010 x 10 + 57013 x 5
55919	1.686,60	57320 x 4 + 57010 x 10 + 57014 x 5
55920	1.715,30	57320 x 4 + 57007 x 5 + 57014 x 10
55921	1.737,40	57320 x 4 + 57011 x 10 + 57014 x 5
55922	1.764,60	57320 x 4 + 57007 x 5 + 57015 x 10
55923	1.812,10	57320 x 4 + 57010 x 5 + 57014 x 10
55924	1.837,60	57320 x 4 + 57011 x 5 + 57014 x 10
55925	1.861,60	57320 x 4 + 57010 x 5 + 57015 x 10
55926	1.886,90	57320 x 4 + 57011 x 5 + 57015 x 10
55927	1.937,20	57320 x 4 + 57014 x 15
55928	1.961,90	57320 x 4 + 57014 x 10 + 57015 x 5
55929	1.986,30	57320 x 4 + 57014 x 5 + 57015 x 10
55930	2.011,10	57320 x 4 + 57015 x 15



Fondo · Width: 385 mm
Altura · Height: 1.750 mm

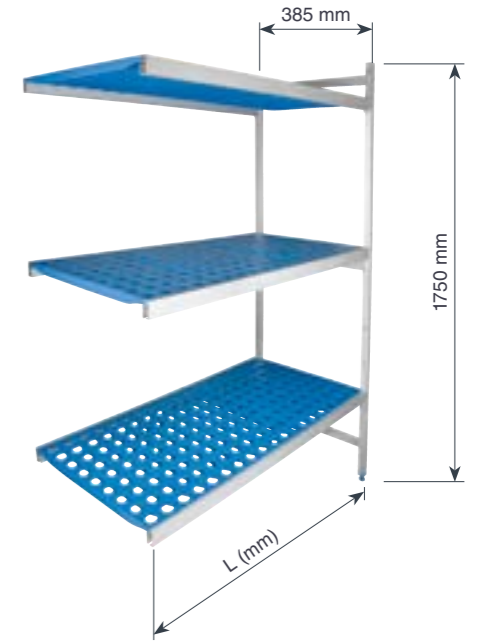

Estantería abierta

Rayonnage ouvertes · Offenes Regale
Open shelving · Estantes abiertas

3 Estantes · Shelf

L (mm)	Ref	€	Desglose · Breakdown
682	55631	232,00	56317 x 1 + 56007 x 3
794	55632	239,50	56317 x 1 + 56008 x 3
904	55633	254,60	56317 x 1 + 56009 x 3
1009	55634	277,10	56317 x 1 + 56010 x 3
1119	55635	292,50	56317 x 1 + 56011 x 3
1229	55636	305,30	56317 x 1 + 56012 x 3
1339	55637	312,50	56317 x 1 + 56013 x 3
1472	55638	342,60	56317 x 1 + 56014 x 3
1554	55639	350,10	56317 x 1 + 56015 x 3

4 Estantes · Shelf

Ref	€	Desglose · Breakdown
55640	279,70	56317 x 1 + 56007 x 4
55641	290,00	56317 x 1 + 56008 x 4
55642	309,60	56317 x 1 + 56009 x 4
55643	339,80	56317 x 1 + 56010 x 4
55644	360,10	56317 x 1 + 56011 x 4
55645	377,10	56317 x 1 + 56012 x 4
55646	387,00	56317 x 1 + 56013 x 4
55647	427,10	56317 x 1 + 56014 x 4
55648	437,20	56317 x 1 + 56015 x 4

5 Estantes · Shelf

Ref	€	Desglose · Breakdown
55649	327,30	56317 x 1 + 56007 x 5
55650	340,30	56317 x 1 + 56008 x 5
55651	365,10	56317 x 1 + 56009 x 5
55652	402,70	56317 x 1 + 56010 x 5
55653	428,20	56317 x 1 + 56011 x 5
55654	449,40	56317 x 1 + 56012 x 5
55655	461,80	56317 x 1 + 56013 x 5
55656	511,80	56317 x 1 + 56014 x 5
55657	524,30	56317 x 1 + 56015 x 5

SIMPLE



Fondo · Width: 385 mm
Altura · Height: 2.000 mm

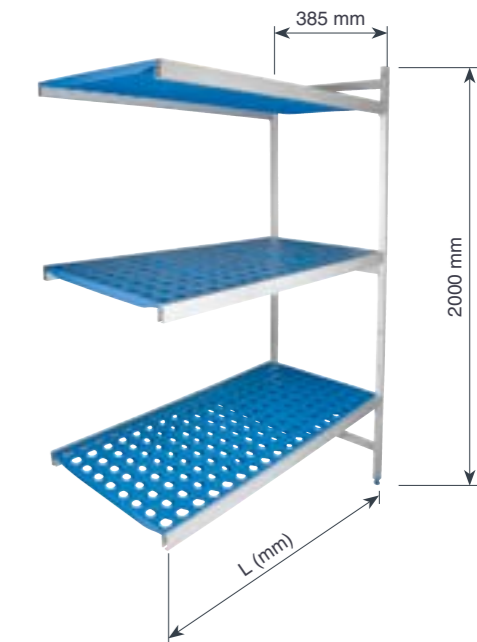

Estantería abierta

Rayonnage ouvertes · Offenes Regale
Open shelving · Estantes abiertas

3 Estantes · Shelf

L (mm)	Ref	€	Desglose · Breakdown
682	55658	246,70	56320 x 1 + 56007 x 3
794	55659	254,60	56320 x 1 + 56008 x 3
904	55660	269,20	56320 x 1 + 56009 x 3
1009	55661	292,10	56320 x 1 + 56010 x 3
1119	55662	307,10	56320 x 1 + 56011 x 3
1229	55663	320,00	56320 x 1 + 56012 x 3
1339	55664	327,30	56320 x 1 + 56013 x 3
1472	55665	356,70	56320 x 1 + 56014 x 3
1554	55666	364,80	56320 x 1 + 56015 x 3

4 Estantes · Shelf

Ref	€	Desglose · Breakdown
55667	294,30	56320 x 1 + 56007 x 4
55668	305,10	56320 x 1 + 56008 x 4
55669	324,60	56320 x 1 + 56009 x 4
55670	354,70	56320 x 1 + 56010 x 4
55671	374,90	56320 x 1 + 56011 x 4
55672	390,90	56320 x 1 + 56012 x 4
55673	401,90	56320 x 1 + 56013 x 4
55674	441,90	56320 x 1 + 56014 x 4
55675	451,90	56320 x 1 + 56015 x 4

5 Estantes · Shelf

Ref	€	Desglose · Breakdown
55676	342,00	56320 x 1 + 56007 x 5
55677	355,10	56320 x 1 + 56008 x 5
55678	379,80	56320 x 1 + 56009 x 5
55679	417,50	56320 x 1 + 56010 x 5
55680	443,00	56320 x 1 + 56011 x 5
55681	464,30	56320 x 1 + 56012 x 5
55682	476,50	56320 x 1 + 56013 x 5
55683	526,50	56320 x 1 + 56014 x 5
55684	539,00	56320 x 1 + 56015 x 5



Fondo · Width: 560 mm
 Altura · Height: 1.750 mm

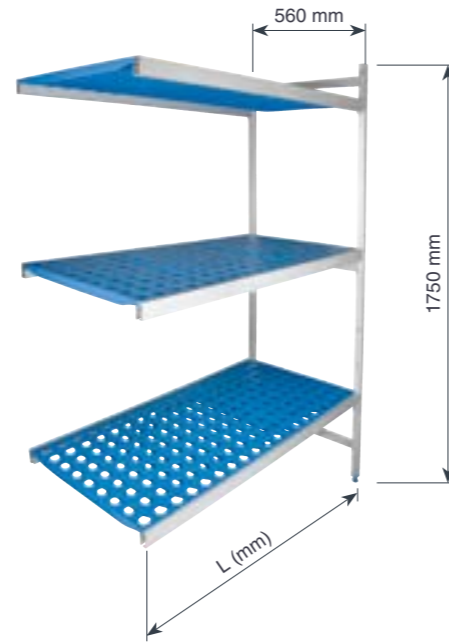

Estantería abierta
 Rayonnage ouvertes · Offenes Regale
 Open shelving · Estantes abiertas

3 Estantes · Shelf

L (mm)	Ref	€	Desglose · Breakdown
682	55931	261,80	57317 x 1 + 57007 x 3
794	55932	269,20	57317 x 1 + 57008 x 3
904	55933	284,40	57317 x 1 + 57009 x 3
1009	55934	320,00	57317 x 1 + 57010 x 3
1119	55935	334,80	57317 x 1 + 57011 x 3
1229	55936	350,10	57317 x 1 + 57012 x 3
1339	55937	364,80	57317 x 1 + 57013 x 3
1472	55938	393,40	57317 x 1 + 57014 x 3
1554	55939	409,60	57317 x 1 + 57015 x 3

4 Estantes · Shelf

Ref	€	Desglose · Breakdown
55940	317,40	57317 x 1 + 57007 x 4
55941	327,10	57317 x 1 + 57008 x 4
55942	347,20	57317 x 1 + 57009 x 4
55943	394,40	57317 x 1 + 57010 x 4
55944	414,90	57317 x 1 + 57011 x 4
55945	433,30	57317 x 1 + 57012 x 4
55946	454,20	57317 x 1 + 57013 x 4
55947	494,30	57317 x 1 + 57014 x 4
55948	514,10	57317 x 1 + 57015 x 4

5 Estantes · Shelf

Ref	€	Desglose · Breakdown
55949	371,60	57317 x 1 + 57007 x 5
55950	384,00	57317 x 1 + 57008 x 5
55951	410,00	57317 x 1 + 57009 x 5
55952	469,10	57317 x 1 + 57010 x 5
55953	494,40	57317 x 1 + 57011 x 5
55954	519,30	57317 x 1 + 57012 x 5
55955	543,80	57317 x 1 + 57013 x 5
55956	593,90	57317 x 1 + 57014 x 5
55957	618,60	57317 x 1 + 57015 x 5

SIMPLE



Fondo · Width: 560 mm
 Altura · Height: 2.000 mm

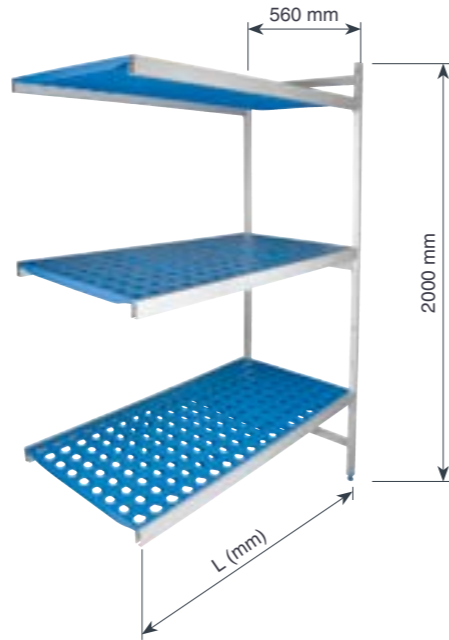

Estantería abierta
 Rayonnage ouvertes · Offenes Regale
 Open shelving · Estantes abiertas

3 Estantes · Shelf

L (mm)	Ref	€	Desglose · Breakdown
682	55958	276,70	57320 x 1 + 57007 x 3
794	55959	284,10	57320 x 1 + 57008 x 3
904	55960	299,30	57320 x 1 + 57009 x 3
1009	55961	334,50	57320 x 1 + 57010 x 3
1119	55962	350,10	57320 x 1 + 57011 x 3
1229	55963	364,80	57320 x 1 + 57012 x 3
1339	55964	379,50	57320 x 1 + 57013 x 3
1472	55965	409,60	57320 x 1 + 57014 x 3
1554	55966	424,50	57320 x 1 + 57015 x 3

4 Estantes · Shelf

Ref	€	Desglose · Breakdown
55967	332,10	57320 x 1 + 57007 x 4
55968	341,70	57320 x 1 + 57008 x 4
55969	361,90	57320 x 1 + 57009 x 4
55970	409,30	57320 x 1 + 57010 x 4
55971	429,60	57320 x 1 + 57011 x 4
55972	449,40	57320 x 1 + 57012 x 4
55973	469,10	57320 x 1 + 57013 x 4
55974	509,10	57320 x 1 + 57014 x 4
55975	528,80	57320 x 1 + 57015 x 4

5 Estantes · Shelf

Ref	€	Desglose · Breakdown
55976	386,70	57320 x 1 + 57007 x 5
55977	399,00	57320 x 1 + 57008 x 5
55978	423,80	57320 x 1 + 57009 x 5
55979	484,00	57320 x 1 + 57010 x 5
55980	509,20	57320 x 1 + 57011 x 5
55981	533,80	57320 x 1 + 57012 x 5
55982	558,60	57320 x 1 + 57013 x 5
55983	608,50	57320 x 1 + 57014 x 5
55984	633,40	57320 x 1 + 57015 x 5

SIMPLE

Cestas
Racks



CESTAS

Colección



226 mm
3° Suplemento
185 mm
2° Suplemento
144 mm
164 mm
1° Suplemento
103 mm
82 mm

208 mm
164 mm
124 mm
103 mm
82 mm

ALTURA DE CESTA / SUPLEMENTO
ALTURA ÚTIL

Verificador de diámetros
Vérifiez le diamètre · Chek the diameter · Diameter prufungen · Medidor de diámetros

49	Compart. Teillen	64x64 mm
36	Compart. Teillen	75x75mm
25	Compart. Teillen	90x90 mm
16	Compart. Teillen	113x113 mm

ES

- La alta calidad de sus materiales hacen que la resistencia al calor y a los impactos sea óptima, por lo que su durabilidad está garantizada.
- Su sistema único de apilación permite un fácil montaje, y lo que es más novedoso, el desmontaje del mismo siempre que usted lo desee.
- Su estructura abierta permite una mayor rapidez en el lavado y secado debido a una mejor circulación de agua y del aire.
- El diseño de las asas hacen que su manejo y carga sean cómodos y sin riesgos. Además, para facilitar su manejo, está disponible un carro porta cestas útil para evitar esfuerzos en los desplazamientos.
- Adaptable a la mayoría de las cestas existentes en el mercado.

FR

- Des matériaux de haute qualité garantissent une résistance optimale à la chaleur et aux chocs. La résistance à la chaleur et aux chocs est optimale, sa durabilité est donc garantie.
- Son système d'empilage unique permet un et, ce qui est encore plus innovant, le démontage de l'ensemble quand vous le souhaitez.
- Sa structure ouverte permet un lavage et un séchage plus rapides. Le lavage et le séchage sont plus rapides grâce à une meilleure circulation de l'eau et de l'air.
- La conception des poignées rend la manipulation et le chargement confortables et sûrs. La manipulation et le chargement sont confortables et sans risque. En outre, un chariot est disponible pour faciliter la manipulation.
- Adaptable à la plupart des paniers du marché.

EN

- The high quality of the materials used in this range give total protection against heat and shocks and thus guarantees durability.
- The unique folding system enables racks to be constructed and dismantled at will.
- The open structure enables a better circulation of both water and air for an easier wash and dry.
- The handle design makes loading and transport easy and risk-free. As an option a dolly is available to assist in the handling of racks.
- This product is compatible with the majority of other dishwasher baskets on the market.



Sistema único de apilación, permite un fácil montaje
Unique folding system enables racks to be constructed



Cesta base

Casier universel · Spülkorb
Universal open rack · Cesta base

Ref	€	cm	U.Venta
69235	34,70	35x35x12	1
69240	35,60	40x40x11	1



Cesta base universal

Casier universel · Universalspülkorb
Universal open rack · Cesta base universal

Ref	€	cm	U.Venta
69250	26,40	50x50x10,3	1



Suplemento altura abierta

Réhausse sans compart. · Ergänzung
Universal open extender · Suplem. altura aberto

Ref	€	cm	U.Venta
69251	11,00	50x50x4,5	1



Cesta base 16 compartimentos

Casier 16 compartiments · Spülkorb 16-tlg.
Rack with 16 compartments · Cesta base 16 compart.

Ref	€	cm	U.Venta
69214	31,60	50x50x10,3	1



Suplem. altura 16 compartimentos

Réhausse, 16 comp. · Ergänzung 16-tlg. Spülkorb
Extender for rack with 16 compart. · Suplem. altura 16 compart.

Ref	€	cm	U.Venta
69217	13,50	50x50x4,5	1



Cesta base 25 compartimentos

Casier 25 compartiments · Spülkorb 25-tlg.
Rack with 25 compartments · Cesta base 25 compart.

Ref	€	cm	U.Venta
69225	33,30	50x50x10,3	1



Suplem. altura 25 compartimentos

Réhausse, 25 comp. · Ergänzung 25-tlg. Spülkorb
Extender for rack with 25 compart. · Suplem. altura 25 compart.

Ref	€	cm	U.Venta
69226	14,40	50x50x4,5	1



Cesta base 36 compartimentos

Casier 36 compartiments · Spülkorb 36-tlg.
Rack with 36 compartments · Cesta base 36 compart.

Ref	€	cm	U.Venta
69236	35,00	50x50x10,3	1



Suplem. altura 36 compartimentos

Réhausse, 36 comp. · Ergänzung 36-tlg. Spülkorb
Extender for rack with 36 compart. · Suplem. altura 36 compart.

Ref	€	cm	U.Venta
69237	14,40	50x50x4,5	1



Cesta base 49 compartimentos

Casier 49 compartiments · Spülkorb 49-tlg.
Rack with 49 compartments · Cesta base 49 compart.

Ref	€	cm	U.Venta
69249	36,00	50x50x10,3	1



Suplem. altura 49 compartimentos

Réhausse, 49 comp. · Ergänzung 49-tlg. Spülkorb
Extender for rack with 49 compart. · Suplem. altura 49 compart.

Ref	€	cm	U.Venta
69248	15,30	50x50x4,5	1



Cesta para platos

Casier pour assiettes · Tellerspülkorb
Small trays and dishes rack · Cesta para pratos

Ref	€	cm	U.Venta
69202	26,50	50x50x10,3	1



Cesta para platos

Casier pour assiettes · Tellerspülkorb
Small trays and dishes rack · Cesta para pratos

Ref	€	cm	U.Venta
69234	35,30	35x35x12	1
69241	41,50	40x40x11	1



Cesta para platos/bandejas

Casier pour grands platex · Plattenspülkorb
Universal open side trays rack · Cesta pratos/bandejas

Ref	€	cm	U.Venta
69203	32,80	50x50x10,3	1



Soporte para platos

Support pour les plats · Tellerhalter
Plate holder · Suporte para pratos

Ref	€	cm	U.Venta
69207	10,30	31,0x9,5x7(15)	1
69213	11,80	34,5x9,5x7(17)	1



Cesta para cubiertos

Casier à couverts · Besteckspülkorb
Flatware/utensil rack · Cesta para talheres

Ref	€	cm	U.Venta
69204	26,10	50x50x10,3	1



Tapa cesta universal

Couvercle pour casier universel · Deckel für Universals Spülkorb
Standard rack's lid · Tampa cesta universal

Ref	€	cm	U.Venta
69205	20,80	50x50x2,5	1



Cesta 8 compart. cubiertos

Panier à couverts, 8 compart. · Besteckspülkorb 8 tlg.
Cutlery rack with 8 compart. · Cesta 8 compart. talheres

Ref	€	cm	U.Venta
69208	16,50	20,5x43x13	1



Cubilete cubiertos

Petit panier à couverts · Besteckbehälter
Cutlery cube · Cesta talheres

Ref	€	cm	U.Venta
69215	5,00	12,5x12,5x13,5	6



100 Kg

Carro porta-cestas

Socle à roulettes pour casier · Transportwagen für Spülkoerbe
Trolley for racks · Carro porta-cestas

Ref	€	cm	U.Venta
69211	206,60	55x57x80	1
69212	125,90	55x57x20	1

Sin asa
Without handle

Limpeza
Cleaning



DISPENSADOR JABÓN/GEL

Colección

ABS

Plastic



ES

- Dispensador manual de jabón y gel.
- Perfecto para almacenar y dispensar geles desinfectantes, jabones, champús u otros materiales líquidos.
- Tamaño compacto; ideal para oficinas, hogares, restaurantes, etc.
- Ventana transparente que permite controlar la cantidad de líquido disponible.
- Diseño para colocar en la pared y ahorrar espacio.
- Depósito extraíble para rellenar fácilmente.

FR

- Distributeur manuel de savon et gel.
- Parfait pour accueillir et distribuer du gel, du désinfectant, du savon, du shampoing, ou tout autre élément liquide.
- Taille compacte ; idéale pour les bureaux, la maison, les restaurants, etc.
- Fenêtre transparente qui permet de contrôler la quantité de liquide disponible.
- Conçu pour être installé sur un mur et ainsi gagner de l'espace.
- Réservoir extractible pour un remplissage facile.

EN

- Manual soap and gel dispenser.
- Perfect for storing and dispensing disinfectant gel, soap, shampoo or other liquids.
- Compact size; ideal for home, office, restaurants, etc.
- It has a transparent window so you can see how much liquid is available.
- It is designed for installing on the wall and to save space.
- Removable container for easy refilling.

PE
polyethylene



Fácil de rellenar
Easy to fill

SAN
plastic



Fácil de rellenar
Easy to fill

Dispensadores de jabón/gel

Distributeur de savon et gel · Seifen- und Gelspender
Soap and gel dispenser · Dispensador de sabão e gel

	Ref	€	ml	Color	U.Venta
A	91520	11,90	350	Cromado · Chrome	1
B	91521	10,80	350	Negro · Black	1

Dispensadores de jabón/gel WHITE

Distributeur de savon et gel · Seifen- und Gelspender
Soap and gel dispenser · Dispensador de sabão e gel

	Ref	€	L	U.Venta
	91525	24,00	1,10	1



Cierre con llave
Lockable with a key

Funcionan con 4 pilas
AA (No incluidas)
Uses 4 AA batteries
(not included)



- Permite ubicar el dispensador de gel en cualquier lugar, sin necesidad de depender de ninguna pared o superficie vertical (Ref. 91540).
- Apto para gel hidroalcohólico y jabón líquido.
- Funcionamiento con sensor, detección entre 5-9 cm de altura.
- Opción de ajustar el caudal entre 0,5 y 2,5 ml.
- Ideal para zonas de gran movimiento de gente.
- Posibilidad de comprar el soporte solo o con el dosificador de gel.

- Permet d'installer le distributeur de gel n'importe où, sans avoir besoin d'un mur ou d'une surface verticale (Ref. 91540).
- Apte pour du gel hydroalcoolique et du savon liquide.
- Fonctionnement avec capteur, détection de 5 à 9 cm de hauteur.
- Option de réglage du débit de 0,5 à 2,5 ml.
- Idéal pour des zones de grand passage.
- Possibilité d'acheter le support seul ou avec le flacon doseur de gel.

- Lets you put a gel dispenser anywhere without needing to rely on any walls or vertical surfaces (Ref. 91540).
- Can be used with hydroalcoholic gel or liquid soap.
- Works using a sensor that can detect at a height of 5 cm to 9 cm.
- The flow can be adjusted from 0.5 ml to 2.5 ml.
- Perfect for areas with a lot of human traffic.
- The support is sold separately or with the gel dispenser.



Posibilidad de colocar en pared
Possibility of wall mounting



Fácil de rellenar
Easy to fill

Dispensadores automáticos de jabón/gel

Distributeur automatique de savon et gel · Automatischer Seifen- und Gelspender
Automatic soap and gel dispenser · Dispensador automático de sabão e gel

	Ref	€	ml	cm	U.Venta
A	91522	80,00	850	11x12x26	1 SILVER
B	91523	80,00	850	11x12x26	1 WHITE

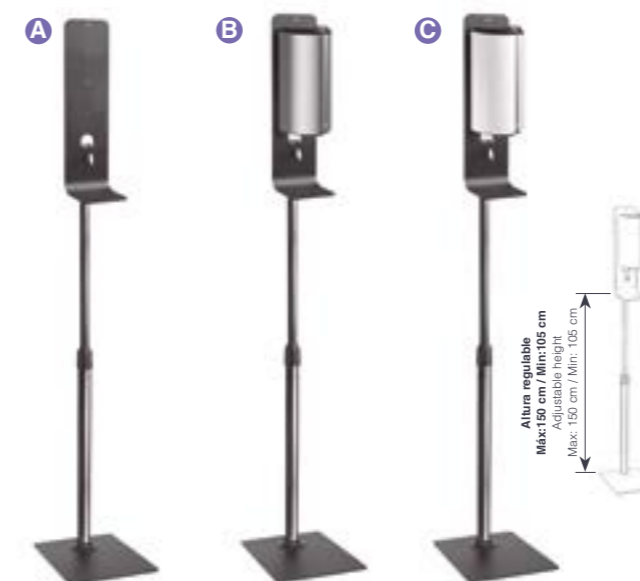

Soporte dispensador de gel

Support distributeur de gel · Gelspenderhalter
Gel dispenser holder · Suporte dispensador de gel

	Ref	€	h (cm)	U.Venta
A	91540	71,10	160	1 Soporte · Support
B	91541	149,20	160	1 Sop. + SILVER · Support + SILVER
C	91542	149,20	160	1 Sop. + WHITE · Support + WHITE



Orificio para colgar
Hanging hole

Flexible y duradera
Flexible and durable



Si
Silicone

Escurreplatos de silicona

Tapis égouttoir en silicone · Abtropfmatte aus Silikon
Silicone dish mat · Escorredor para pratos de silicona

	Ref	€	cm	U.Venta
	66774	17,70	42,5x32	1

- Escurreplatos de silicona antideslizante para colocar en la encimera y dejar secar los platos recién fregados.
- Su diseño con relieves proporciona una buena ventilación para un secado rápido de la vajilla, cacerolas, utensilios, platos, copas, etc.
- El agua queda retenida entre los surcos para su posterior vaciado en el fregadero.
- Fácil de enrollar para guardarla en cualquier cajón o armario de la cocina.

- Tapis égouttoir en silicone antidérapant à installer sur le plan de travail pour laisser sécher la vaisselle qui vient d'être lavée.
- Sa conception avec des reliefs apporte une bonne ventilation pour un séchage rapide de la vaisselle, des casseroles, des ustensiles, des assiettes, des verres, etc.
- L'eau est retenue entre les creux pour ensuite être évacuée dans l'évier.
- Facile à enrouler pour le ranger dans n'importe quel tiroir ou meuble de cuisine.

- Non-slip silicone dish mat to put on the countertop and let recently washed dishes dry.
- Its ridged design provides good ventilation for drying dishes, casseroles, utensils, plates or glasses quickly.
- The water gets captured between the grooves so it can be emptied into the wash basin.
- It's easy to roll up and store in any drawer or cabinet in the kitchen.

PAPELERAS

Colección

Inox PP
Polypropylene
Container



ES

- Fabricadas en acero inoxidable de gran calidad
- Tapa 100% de bambú natural (63335/63355).
- Ideal para baños de hoteles, restaurantes y todo tipo de establecimientos.
- Prácticas, compactas y funcionales.
- Superficie en acabado gris / blanco / negro mate.
- Apertura de tapa mediante pedal.
- Sistema de cierre SoftClosing; la tapa se cierra suave y silenciosamente.
- Cubeta interior extraíble de polipropileno con asa.
- Pies antideslizantes.

FR

- Fabriqué en acier inoxydable de haute qualité
- Couvercle en bambou 100 % naturel (63335/63355).
- Idéale pour les salles de bain des hôtels, des restaurants et de tout type d'établissement.
- Compactes et fonctionnelles.
- Surface in gray / white / matt black finish.
- Ouverture du couvercle par pédale.
- Système de fermeture **SoftClosing** : le couvercle se referme doucement et silencieusement.
- Cuve intérieure extractible en polypropylène a/anse.
- Pieds antidérapants.

EN

- Made of high quality stainless steel.
- 100% natural bamboo lid (63335/63355).
- Perfect for hotel bathrooms, restaurants and all kinds of businesses.
- Practical, compact and functional.
- Surface in grey / white / black matt finish.
- The lid opens using a pedal.
- SoftClosing system: the lid closes smoothly and silently.
- It has a removable polypropylene inner liner with a handle.
- Non-slip feet.



Tapa desmontable
Tapa de práctico giro
Removable lid
Practical swing lid



Inox
18/10

Papelera sobremesa
Poubelle de table · Tisch-Abfallbehälter
Table bin · Papeleira de mesa

Ref	€	Ø (cm)	h (cm)	L	U.Venta
63302	24,10	12	16	1,20	1



Sistema de cierre
SoftClosing
Closing system
SoftClosing



Cubeta interior
extraíble de
polipropileno con
asa

It has a removable
polypropylene inner
liner with a handle

Papelera con pedal INOX
Poubelle à pédale · Tret-Abfallbehälter
Pedal bin · Papeleira com pedal

Ref	€	Ø (cm)	h (cm)	L	U.Venta
63303	22,10	17,0	25,5	3,0	1
63305	28,90	20,5	28,0	5,0	1
63312	42,70	25,0	40,0	12,0	1
63319	61,20	29,0	45,0	20,0	1



Papelera con pedal
Poubelle à pédale · Tret-Abfallbehälter
Pedal bin · Papeleira com pedal

Ref	€	Ø (cm)	h (cm)	L	Color	U.Venta
63306	23,30	16,8	25	3,0	GREY	1
63307	23,30	16,8	25	3,0	WHITE	1
63309	23,30	16,8	25	3,0	BLACK	1

Bambú
Bamboo

FE
Hermetic



Papelera con pedal NATURE
Poubelle à pédale · Tret-Abfallbehälter
Pedal bin · Papeleira com pedal

Ref	€	Ø (cm)	h (cm)	L	Color	U.Venta
63335	54,80	20,5	27,6	5,0	BLACK	1
63355	54,80	20,5	27,6	5,0	WHITE	1



Sistema de cierre
SoftClosing
Closing system
SoftClosing



Cubeta interior
extraíble de
polipropileno con
asa
It has a removable
polypropylene inner
liner with a handle



Sistema de cierre
SoftClosing
Closing system
SoftClosing



Cubeta interior
extraíble de
polipropileno con
asa
It has a removable
polypropylene inner
liner with a handle

RECOGEMIGAS

Colección

Inox
18/10



Cepillo recogemigas

Ramasse-miettes à rouleaux · Krümelbürste
Crumbs cleaner · Escova apanha-migalhas

Ref	€	cm	h (cm)	U.Venta
64407	14,70	9,5x16,5	4,0	1



Cepillo recogedor HIPERLUXE

Ramasse-miettes à rouleaux · Krümelbürste
Crumbs cleaner · Escova apanha-migalhas

Ref	€	cm	U.Venta
64408	49,70	14,5x17	1



Cepillo recogedor LUXE

Ramasse-miettes à rouleaux · Krümelbürste
Crumbs cleaner · Espátula apanha-migalhas

Ref	€	cm	U.Venta
64409	30,90	22x7	1

PORTARROLLOS COCINA

Colección

Inox
18/10

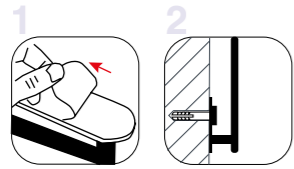

2 opciones para instalar
2 options to install



Inox

Portarrollos de cocina BLACK

Derouleur de cuisine · Küchenrollenspender
Dispenser for kitchen · Porta-rolos cozinha

Ref	€	cm	h (cm)	U.Venta
62289	14,50	33,5x4,5	8	1

- Fabricado en acero inoxidable de alta calidad, acabado negro mate.
- Duradero y resistente, a prueba de óxido.
- Diseño moderno y elegante. Capacidad: 1 rollo de cocina (longitud de rollos: 30 cm y 6 cm de grosor).
- Perfecto para colocar el papel de cocina y mantener la encimera despejada.
- Fácil de instalar. Opción de colocar mediante papel adhesivo o perforado con tornillos (ambos incluidos).
- Se puede instalar vertical u horizontalmente según las necesidades.

- Fabriquée en acier inoxydable de haute qualité, finition noire mate.
- Durable et résistant, antirouille.
- Design moderne et élégant. Capacité : 1 rouleau de papier de cuisine (longueur maximale de 30 cm et épaisseur de 6 cm).
- Parfait pour placer le rouleau de papier cuisine et garder le plan de travail dégagé.
- Facile à installer. Installation possible avec du papier adhésif ou perforé avec des vis (les deux inclus).
- Peut être installé verticalement ou horizontalement selon les besoins.

- Made of high quality stainless steel in a matt black finish.
- Long-lasting, sturdy and rust-proof.
- Modern, stylish design. Capacity: 1 kitchen roll (maximum length 30 cm, 6 cm thick).
- Perfect for paper kitchen rolls and keeping the worktop clear.
- Easy to install. Adhesive paper or screw hole mounting options (both included).
- Can be mounted vertically or horizontally as required.



Base contrapeso
Counterbalance base
1 Kg



Pie portarrollos

Dérrouleur pour papier essuie-tout · Spänder für Küchenrolle
Kitchen roll dispenser stand · Pé porta-rolos

Ref	€	Ø (cm)	h (m)	U.Venta
50301	19,90	15	32,5	6



Rollos aptos para los portarrollos · Rolls suitable for multiroll dispenser

Ref.	Film transparente · Transparent film	Rollo aluminio · Aluminium foil	Rollo papel · Paper roll
60701	Ø50x320 mm	Ø50x320 mm	Ø180x330 mm
60702	Ø48x340 mm	Ø60x340 mm	Ø170x330 mm

Portarrollos de cocina de pared

Derouleur de cuisine · Küchenrollenspender
Multiroll dispenser for kitchen · Porta-rolos cozinha de parede

Ref	€	U.Venta
A 60701	58,80	6
B 60702	55,40	8



Bobina aluminio

Rouleau aluminium · Aluminiumfolie
Aluminium foil · Bobina alumínio

Ref	€	Film (m)	Caja (cm)	Micras (µm)	U.Venta
10330	55,20	0,30x300	10x35	11	1
10430	67,80	0,40x300	10x42	11	1



Bobina film transparente

Rouleau film transparent · Frischhaltefolie
Transparent cling film · Bobina filme transparente

Ref	€	Film (m)	Caja (cm)	Micras (µm)	U.Venta
11330	14,10	0,30x300	10x33	10	1
11430	21,80	0,45x300	10x48	10	1

Servilletero bar

Distributeur de serviettes bar · Serviettenspender
Bar napkin holder · Guardanapo bar

Ref	€	cm	Servilleta	U.Venta
A 61001	13,20	8,5x12	90x125	1
B 61002	9,40	9,5x13,5	9,5x13,5	4

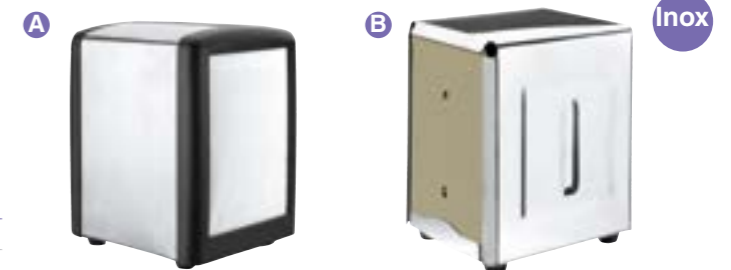

Inox



Rasqueta profesional para grill

Racloir professionnel pour grill · Professioneller grillschaber
Professional grill scraper · Raspador profesional para grill

Ref	€	cm	L Cuchilla (cm)	U.Venta
67034	70,70	42x15x12	15	1

AL
Aluminium

FU
Fundido
Cast

- Fabricada en una sola pieza de aluminio fundido.
- Cuchillas de acero inoxidable intercambiables.
- Se utiliza para raspar los residuos de los alimentos y el carbón de las planchas.
- Ergonómico gracias a los dos puntos de sujeción.
- Protección contra salpicaduras de residuos durante la limpieza.

- Fabriquée en une seule pièce en fonte d'aluminium.
- Lames en acier inoxydable interchangeables.
- Utilisée pour racle les résidus des aliments et le charbon des planchas.
- Ergonomique grâce aux deux points de prise en main.
- Protection contre les éclaboussures de résidus pendant le nettoyage.

- Made of a single piece of cast aluminium.
- Interchangeable stainless steel blades.
- Used to scrape food and charcoal residue from grills.
- Ergonomic design with two hand-holds.
- Splash guard to prevent residue from splashing upward during cleaning.

CENICEROS

Colección

Inox
18/10

ES

- Ceniceros para pared exterior.
- Cerradura con llave.
- Incluye material para fijación y una llave triangular.
- Cajetín interior de acero galvanizado extraíble para facilitar su limpieza.

FR

- Cendriers pour mur extérieur.
- Fermeture à clé.
- Comprend le matériel de fixation et une clé triangulaire.
- Boîtier intérieur en acier galvanisé extractible pour faciliter son nettoyage.

EN

- Outdoor wall ashtray.
- Lock with key.
- Includes attachment elements and triangular key.
- Removable galvanized steel inner box for easy cleaning.



Cajón extraíble de acero galvanizado
Removable galvanized steel inner box

Cajón extraíble de acero galvanizado
Removable galvanized steel inner box

Acero galvanizado
Galvanized steel

Cenicero pared

Mural cendrier · Wand aschenbecher
Wall ash try · Cinzeiro de parede

	Ref	€	cm	h (cm)	U.Venta
A	63341	87,00	24,5x35	14	1
B	63342	81,50	25x35	8,5	1

Cenicero redondo

Cendrier extérieur rond · Aschenbecher round
Round ash try · Cinzeiro redondo

	Ref	€	Ø (cm)	L	U.Venta
	63331	91,00	8x46	1,70	1
A	R63331A	3,90	-	-	1
	63332	145,50	8x92	1,50	1
B	R63332A	3,90	-	-	1

A



Colocación en pared
Wall mounting

B



Posición de pie
Standing position

POSTES SEPARADORES BLACK

Colección

FE
Hierro/Iron

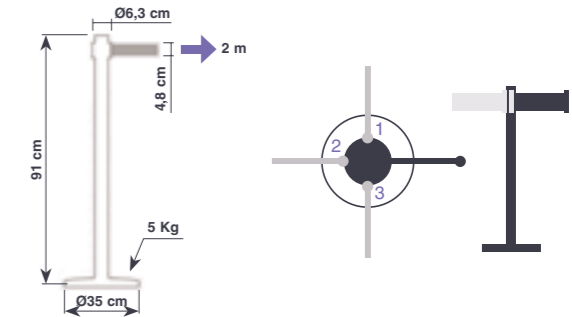
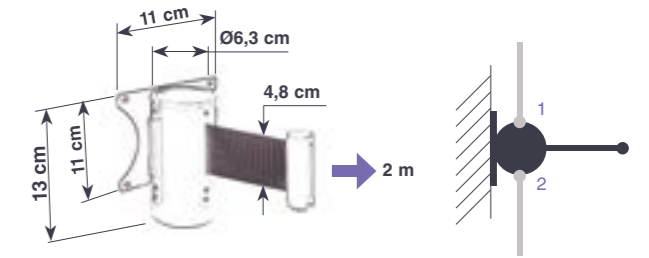

ES

- Ideal para la gestión de colas o separación de espacios.
- Estructura fabricada en hierro con recubrimiento de color negro.
- Cinta extensible retráctil de 2 m de longitud.
- Fácil de fijar y soltar las conexiones.

FR

- Idéal pour la gestion de files d'attente ou la séparation d'espaces.
- Structure fabriquée en métal, recouverte de couleur noire.
- Sangle extensible rétractable de 2 m de longueur.
- Facilité de fixation et de détachement des connexions.

EN

- Perfect for managing queues or separating spaces.
- Iron structure with black coating.
- 2 m long extendible retractable belt.
- The connections are easy to attach and release.

Dispone de 2 conexiones
Permite conectar cintas para crear áreas separadas
2 connections for connecting belts from other posts

Dispone de 3 conexiones
Permite conectar cintas para crear áreas separadas
3 connections for connecting belts from other posts



Fijación en pared
Wall fixing

Separador pared

Séparateur mural · Wandtrennpfosten
Wall separator · Separador de parede

	Ref	€	metros	U.Venta
A	91530	36,60	2	1
B	R91533A	1,70	-	1

(Incluye R91533A · Included)
(Apta para la ref. 91533 · Suitable for ref.91533)



Acero inoxidable
Stainless steel

Poste separador

Poteau séparateur · Trennpfosten
Separator post · Poste separador

	Ref	€	metros	U.Venta
	91533	56,90	2	1

JARRAS MEDIDORAS

Colección

Inox
18/10
Dishwasher



PMMA
plastic
BPA free

Incluye borde para facilitar el vertido
Includes rim for easy pouring



Vaso medidor BASIC

Verre doseur · Messbecher
Measuring cup · Copo medidor

	Ref	€	Ø (cm)	h (cm)	L	U.Venta
A	67075	7,40	8,5	16,0	0,5	1
B	67071	9,60	10,5	19,0	1,0	1

Marcajes de capacidad en ml, dl, onzas y cup
Capacity markings in ml, dl, ounces and cups

New



Set 3 jarras medidoras

Setn 3 pichets doseurs · Messbecher, 3 Er-Setr
Set of 3 measuring jugs · Conjunto 3 jarras medidas

Ref	€	Ø (cm)	h (cm)	L	U.Venta
67130	9,20	9,5	8,5	0,25	1
		11,0	10,0	0,50	
		13,0	11,5	1,00	

- Fabricadas en polipropileno de máxima calidad. 100% libres de BPA.
- Jarras graduadas en mililitros (ml), tazas (cup) y onzas (oz).
- Pico vertedor para facilitar el vertido y evitar derrames.
- Asa ergonómica con reposapulgares para facilitar el transporte, precisión y control en el vertido. Ambidiestro.
- Totalmente apilables, ocupando el mínimo espacio posible.

- Fabriqués en polypropylène de la plus grande qualité. 100% sans BPA.
- Pichets gradués en millilitres (ml), tasses (cup) et onces (oz).
- Bec verseur latéral pour mieux verser les liquides.
- Poignée ergonomique avec repose-pouces pour faciliter le transport et verser les liquides de façon plus précise et contrôlée. Ambidextre.
- Totalement empilables pour un gain de place maximum.

- Made of top quality polypropylene. 100% BPA free.
- Jugs graduated in millilitres (ml), cups (cup) and ounces (oz).
- Side spout for easy pouring.
- Ergonomic handle with thumb rest for easy carrying, precision and control when pouring. Ambidextrous.
- Fully stackable, taking up as little space as possible.



Marcajes de capacidad en el interior en onzas, ml, L y ccm (centímetro cúbico)
Capacity markings inside in ounces, ml, L and ccm (cubic centimetres)

Jarra medidora

Pot mesureur · Mass Behälter
Measuring jug · Jarra de medidas

Ref	€	Ø (cm)	h (cm)	L	U.Venta	
A	62745	14,40	9,0	10,5	0,5	1
B	62741	21,80	11,5	13,0	1,0	1
C	62742	25,80	15,0	17,0	2,0	1

PP
polypropylene
BPA free

Jarras medidoras

Pot mesureur · Mass Behälter
Measuring jugs · Jarras de medidas

Ref	€	Ø (cm)	h (cm)	L	U.Venta	
A	67210	3,50	9,0	13,8	0,5	1
B	67211	4,60	12,0	17,0	1,0	1
C	67212	7,90	15,0	20,8	2,0	1
D	67213	10,30	17,0	23,5	3,0	1
E	67214	16,00	20,0	27,5	5,0	1



Sistema de lectura rápida en ml, L y ccm (centímetro cúbico)
Easily readable markings in ml, L and ccm (cubic centimeter)

Vidrio
Glass

100% higiénica
100% hygienic



Resistente a choques térmicos
Highly resistant to thermal shock

Jarra medidora CRISTAL

Pot mesureur · Mass Behälter
Measuring jug · Jarra de medidas

Ref	€	L	U.Venta
67133	11,00	0,5	1

PMMA
plastic
BPA free



Sist. de lectura rápida en mililitros y cups
Easily readable markings in millilitres and cups

Jarra medidora SPIN

Pot mesureur · Mass Behälter
Measuring jug · Jarra de medidas

Ref	€	L	U.Venta
67165	11,80	0,5	1

SAN
plastic
BPA free



Lectura rápida en litros, mililitros, onzas y cups
Readable markings in liters, millilitres, ounces and cups

Juego 3 jarras medidoras

Ensemble de 3 pot mesureur · 3-tlg. Satz Messbecher
3 piece measuring jugs · Jogo 3 jarras de medidas

Ref	€	L	U.Venta
67131	15,20	0,25-0,5-1,0	1

PP
polypropylene
BPA free

Set 5 jarras medidoras

Setn 5 pichets doseurs · Messbecher, 5 Er-Setr
Set of 5 measuring jugs · Conjunto 5 jarras medidas

Ref	€	cm	h (cm)	L	U.Venta
67215	39,90	15x9	15,3	0,5	1
		18x11	18,8	1,0	
		22x15	23,0	2,0	
		24x17	26,0	3,0	
		27x20	30,2	5,0	



Jarras apilables
Stackable jugs

Sistema de lectura rápida en mililitros (ml), litros (L) y ccm (centímetro cúbico)
Easily readable markings in milliliters (ml), Liters (l) and ccm (cubic centimeter)

EXACT & PRACTIC

Set de medición

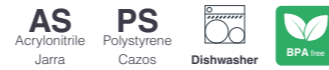

- ES** · Versátil. Ideal para ingredientes líquidos y secos.
 · Jarra con sistema de lectura rápida en litros y cups. Permite comprobar el nivel del líquido mientras se está vertiendo el contenido.
 · Cazos marcados en ml y bps para una rápida identificación.

- FR** · Polyvalent, idéal pour les ingrédients liquides et secs.
 · Pichet avec système de lecture rapide en litres et cups. Permet de vérifier le niveau du liquide tout en versant le contenu.
 · Cuillères marquées en ml et bps pour une identification rapide.

- EN** · Versatile: ideal for liquid and dry ingredients.
 · Jug with easy to see quantities marked in litres and cups and easy to check liquid level while pouring contents.
 · Ladles with ml and bps markings for easy reference.

Raspador · Scraper

6 cazos medidores

6 measuring cups
 (7,5 ml, 15 ml, 60 ml,
 85 ml, 125 ml, 250 ml)

Embudo · Funnel

Jarra medidora
 Measuring jug
 (1,0 L / 4 cups)



Compacto · Compact

Set de medición EXACT

Set de mesure · Messbecher-Set
 Measuring set · Conjunto de medição

Ref	€	cm)	h (cm)	L	U.Venta
62740	16,00	20x11	13,6	1,0	1

- ES** · Fabricadas en polipropileno de máxima calidad. 100% Libre de BPA.
 · Pequeño vertedor lateral para facilitar el vertido.
 · Asas ergonómicas para facilitar el transporte.
 · 100% estable gracias a los pies antideslizantes.

- FR** · Fabriqués en polypropylène de la plus grande qualité. 100% sans BPA.
 · Petit verseur latéral pour verser plus facilement.
 · Poignées ergonomiques pour faciliter le transport.
 · 100% stables grâce aux pieds antidérapants.

- EN** · Made of top quality polypropylene. 100% BPA free.
 · Small side spout for easy pouring.
 · Ergonomic handles for easy carrying.
 · 100% with non-slip feet.



Graduadas (mililitros / cups)
 Graduated ml and cup marking

Set 4 boles PRACTIC

Ensemble de 4 récipients · Schüsseln, 4er-Set
 Set of 4 bowls · Conjunto de 4 tigelas

Ref	€	Ø (cm)	h (cm)	L	U.Venta
62633	35,10	11,5	9,3	0,5	1
		14,5	10,6	1,0	
		18,5	13,0	2,0	
		22,0	15,0	3,5	

CAZOS · CUCHARAS

Medición



Graduadas y marcadas en ml y tsp
 Marked and graduated in ml and cups

Juego de cucharas medidoras
 Ensemble de cuillères à doser · Messlöffel-Set
 Measuring set · Jogo de colheres de medidas

	Ref	€	ml	U.Venta
A	67001	10,70	0,62/1,25/2,5/5/15	1
B	67037	4,00	1,25/2,5/5/15	1

Graduadas y marcadas en ml y tsp
 Marked and graduated in ml and cups

Juego de cazos medidores
 Ensemble de dosettes à doser · Mass-Pfännchen-Set
 Measuring cup · Jogo de caçaroles de medidas

	Ref	€	ml	U.Venta
A	67007	11,60	60/80/125/250	4
B	67036	6,10	60/80/120/180/235	4



Muestra los resultados en gramos (g) y onzas (oz)
 Shows the results in grams (g) and ounces (oz)

Cuchara medidora digital
 Cuillère avec Balance Digital · Digitale Löffelwaage
 Digital spoon scale · Colher de pesar Digital

Ref	€	g	División (g)	L (cm)	U.Venta
62519	39,50	300	0,10	28	1



Librador

Pelle à farine · Mehlschaufel
 Ice shovel · Corredor

Ref	€	ml	L (cm)	A (cm)	U.Venta
67012	17,40	60	19,0	5,0	6
67013	20,30	110	21,5	6,0	6
67014	23,90	200	24,0	7,0	6
67016	26,60	260	25,5	8,5	1
67017	29,50	360	29,0	10,0	6
67018	31,80	470	31,0	11,0	6
67019	39,60	640	35,0	12,5	6
67020	47,40	860	38,0	14,0	6



- Calcula con exactitud el peso de cantidades pequeñas de especias, leche, aceite, harina o cualquier otro ingrediente.
- Esta cómoda cuchara cabe en cualquier cajón y se puede colgar o colocar en cualquier estantería de la cocina. Su nueva función de acumulación permite medir pesos hasta 3.000 g / 105,8 oz.
- Desmontable.
- Apagado automático tras 1 minuto sin usar.

- Provides a precise measuring result whenever you weigh a small quantity of spices, milk, oil, flour or other ingredients.
- This very handy scale fits into any drawer or can be hung or placed on every kitchen rack. The new accumulation function now offers the possibility to measure weights up to 3000 g / 105.8 oz.
- Removable.
- Powers off automatically after 1 minute.



Librador

Pelle à farine · Mehlschaufel
 Ice shovel · Corredor

	Ref	€	ml	Mango (cm)	U.Venta
A	67021	5,70	170	12	1
B	67022	11,60	900	12	1
C	67023	15,90	1800	14	1

BOLES INOX

Colección



ES

- Set de 3 boles de acero inoxidable de máxima calidad.
- Acabado interior y exterior satinado.
- Versátiles: ideales para mezclar, batir, preparar masas y servir ensaladas o salsas.
- Perfectos para almacenar y conservar los alimentos.
- Compuesto por 3 boles perfectamente apilables entre sí.
- Base 100% antideslizante.
- Incluye 3 tapas herméticas fabricadas en polipropileno, libres de BPA.
- Marcaje de capacidad en el interior (L).
- Fácil limpieza. No aptos para el lavavajillas.

FR

- Ensemble de 3 bols en acier inoxydable de la plus grande qualité.
- Finition intérieure et extérieure satinée.
- Polyvalents : parfaits pour mélanger, battre, préparer des pâtes et servir des salades ou des sauces.
- Parfaits pour ranger et conserver les aliments.
- Composé de 3 bols parfaitement empilables entre eux.
- Fond 100% antidérapant.
- Inclut 3 couvercles hermétiques fabriqués en polypropylène, sans BPA.
- Marquage de capacité à l'intérieur (L).
- Nettoyage facile. Ne convient pas au lave-vaisselle.

EN

- Set of 3 top quality stainless steel bowls.
- Inner and outer satin finish.
- Versatile: ideal for mixing, whisking, making doughs and serving salads or sauces.
- Ideal for storing and preserving food.
- Comprises 3 perfectly stackable.
- 100% non-slip base.
- Includes 3 airtight lids made of BPA-free polypropylene.
- Capacity marks inside (L).
- Easy to clean. Not suitable for the dishwasher.



Set 3 boles INOX

Ensemble de 3 récipients · Schüsseln, 3er-Set
Set of 3 bowls · Conjunto de 3 tigelas

Ref	€	Ø (cm)	h (cm)	L	U.Venta
60050	39,20	16	10,0	1,5	1
		18	11,0	2,2	
		20	12,5	3,0	
60051	52,80	20	12,5	3,0	1
		22	13,5	3,8	
		24	14,0	4,0	

garinox®



Bol cónico

Bol conique · Schüssel, konisch
Conical mixing bowl · Bacia cónica

Ref	€	Ø (cm)	h (cm)	L	U.Venta
14016	3,80	16	6,5	0,90	12
14019	5,20	20	7,5	1,40	12
14025	9,40	24	9,0	2,50	1
14029	12,80	30	11,0	4,30	1
14033	17,80	34	13,5	7,50	1
14040	22,70	40	15,5	11,50	1
14046	32,20	45	17,5	17,40	1
14049	37,80	50	19,0	22,60	1

BOLES PP

Colección



ES

- Versátiles: ideales para mezclar, batir, preparar masas y servir ensaladas o salsas.
- Compuesto por 3 boles perfectamente apilables entre sí.
- Dispone de pico vertedor y pestaña de agarre antideslizante.
- Base 100% antideslizante.

FR

- Polyvalents : parfaits pour mélanger, battre, préparer des pâtes et servir des salades ou des sauces.
- Composé de 3 bols parfaitement empilables entre eux.
- Bec verseur et poignée antidérapante pour une meilleure prise en main.
- Fond 100% antidérapant.

EN

- Versatile: ideal for mixing, whisking, making doughs and serving salads or sauces.
- Comprises 3 perfectly stackable bowls.
- Featuring a pouring spout and non-slip grip. 100% non-slip base.

ES

- Versátiles: ideales para mezclar, batir, preparar masas, servir ensaladas o salsas.
- Compuesto por 6 boles perfectamente apilables entre sí.
- Incluye 6 tapas fabricadas en polipropileno, libres de BPA.
- Perfectos para almacenar y conservar los alimentos.

FR

- Polyvalents : parfaits pour mélanger, battre, préparer des pâtes et servir des salades ou des sauces.
- Composé de 6 bols parfaitement empilables entre eux.
- Comprend 6 couvercles en polypropylène, sans BPA.
- Parfait pour stocker et conserver les aliments.

EN

- Versatile: ideal for mixing, whisking, making doughs, serving salads or sauces.
- Comprises 6 perfectly stackable bowls.
- Includes 6 lids made of polypropylene, BPA free.
- Perfect for storing and preserving food.



Set 3 boles GREY

Ensemble de 3 récipients · Schüsseln, 3er-Set
Set of 3 bowls · Conjunto de 3 tigelas

Ref	€	Ø (cm)	h (cm)	L	U.Venta
60054	41,80	21,0	12,5	1,4	1
		26,0	14,2	2,8	
		31,2	14,8	4,7	

Cuerpos aptos para el lavavajillas
Dishwasher safe bodies



Set 6 boles MULTI

Ensemble de 6 récipients · Schüsseln, 6er-Set
Set of 6 bowls · Conjunto de 6 tigelas

Ref	€	Ø (cm)	h (cm)	L	U.Venta
60055	20,00	10,0	5,0	0,25	1
		14,0	6,8	0,80	
		17,0	8,0	1,15	
		20,3	9,5	2,00	
		24,3	11,0	3,35	
		28,3	12,5	5,25	

CALDEROS INOX

Colección



ES

- Ideal para mezclar los alimentos.
- Para uso profesional o doméstico.
- Fabricados en acero inoxidable 18/10, material muy resistente a la corrosión y ácidos alimentarios.
- Fácil limpieza: apto para el lavavajillas.

FR

- Idéal pour mélanger les aliments.
- Pour un usage professionnel ou domestique.
- Fabriqué en acier inoxydable 18/10, un matériau hautement résistant à la corrosion et aux acides.
- Nettoyage facile : passe au lave-vaisselle.

EN

- Ideal for mixing food.
- For professional or home use.
- Made of 18/10 stainless steel, a material highly resistant to corrosion and food acids.
- Easy cleaning: dishwasher safe.



Caldero semiesférico sin asas

Bassine hemispherique s/anses · Schneeschlagkessel ohne Griffe
Semi-spherical mixing bowl w/out/handles · Bacia semi-esférica sem asas

Ref.	€	Ø (cm)	h (cm)	L	U.Venta
50323S	36,50	22	11,0	2,70	1
50327S	42,60	26	13,0	4,00	1
50333S	57,20	32	17,0	9,50	1
50337S	64,90	36	18,0	12,00	1
50341S	108,90	40	21,0	14,50	1
50300	25,70	-	-	-	1

Soporte
Bowl stand



Caldero semiesférico con asas

Bassine hemispherique a/anses · Schneeschlagkessel mit Griffe
Semi-spherical mixing bowl w/handles · Bacia semi-esférica com asas

Ref.	€	Ø (cm)	h (cm)	L	U.Venta
50323	48,10	22	11,0	2,70	1
50327	54,70	26	13,0	4,00	1
50333	70,30	32	17,0	9,50	1
50337	75,60	36	18,0	12,00	1
50341	108,10	40	21,0	14,50	1
50300	25,70	-	-	-	1

Soporte
Bowl stand



Caldero cónico

Bassine conique · Wanne
Mixing bowl · Bacia cónica

Ref.	€	Ø (cm)	h (cm)	L	U.Venta
60013	12,40	13	6,1	0,55	1
60016	13,40	16	9,1	1,00	1
60020	18,40	20	11,7	2,12	1
60024	22,10	24	12,6	3,50	1
60028	27,60	28	13,4	5,25	1
60032	31,00	32	15,0	7,65	1
60036	42,90	36	16,0	11,00	1
60040	49,80	40	18,0	15,00	1



Caldero cónico con asas

Bassine conique à anses · Wanne mit Griffe
Conical mixing bowl · Bacia cónica con asas

Ref.	€	Ø (cm)	h (cm)	L	U.Venta
50828	43,10	28	13,2	5,00	1
50832	47,80	32	14,5	7,00	1
50836	54,70	36	16,0	11,00	1
50840	60,80	40	18,0	15,00	1
50845	72,60	45	20,0	22,00	1
50850	87,10	50	21,0	30,00	1

CEDAZOS INOX

Colección



50 orificios/pulgada
50 eyes/inch
Cuadrado: 0,35x0,35 mm
Square: 0,35x0,35 mm



35 orificios/pulgada
35 eyes/inch
Cuadrado: 0,50x0,50 mm
Square: 0,50x0,50 mm

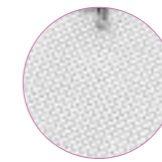

25 orificios/pulgada
25 eyes/inch
Cuadrado: 0,75x0,75 mm
Square: 0,75x0,75 mm

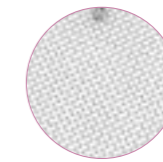

20 orificios/pulgada
20 eyes/inch
Cuadrado: 1x1 mm
Square: 1x1 mm

Cedazo

Tamis · Mehlsieb
Sieve · Peneira

Hilos por pulgada · Wires-inch= 50				Hilos por pulgada · Wires-inch= 35				Hilos por pulgada · Wires-inch= 25				Hilos por pulgada · Wires-inch= 20			
Ref	€	Ø (cm)	U.Venta	Ref	€	Ø (cm)	U.Venta	Ref	€	Ø (cm)	U.Venta	Ref	€	Ø (cm)	U.Venta
68058	38,50	18	1	68350	38,70	20	1	68250	38,40	20	1	68026	60,60	26	1
68050	42,10	20	1	68357	58,30	26	1	68252	57,90	26	1	68023	67,50	30	1
68057	58,40	26	1	68351	66,00	30	1	68253	64,40	30	1	68024	101,80	40	1
68053	70,40	30	1	68354	98,70	40	1	68254	99,70	40	1				
68054	96,10	40	1												

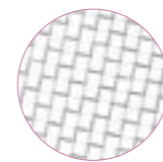

9 orificios/pulgada · 8 eyes/inch
Cuadrado · Square: 2x2 mm
Ø Varilla · Rod: 0,40 mm

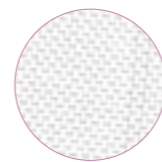

20 orificios/pulgada · 20 eyes/inch
Cuadrado · Square: 1x1 mm
Ø Varilla · Rod: 0,27 mm

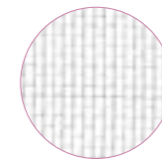

12 orificios/pulgada · 12 eyes/inch
Cuadrado · Square: 1,35x1,35 mm
Ø Varilla · Rod: 0,35 mm



40 orificios/pulgada · 40 eyes/inch
Cuadrado · Square: 0,7x0,7 mm
Ø Varilla · Rod: 0,12 mm

Cedazo 4 mallas intercambiables

Tamis à 4 mailles interchangeables · 4 Austauschbare Masche-Sieb
Mesh sieve interchangeable · Peneira de 4 malha intercambiáveis

Ref	€	Ø (cm)	U.Venta
68340	33,00	20	1
68341	39,80	23	1
68342	49,40	25	1

Ideal para harina, chocolate en polvo, levaduras, etc.

Mecanismo en el asa en forma de gatillo

Ideal for flour, chocolate powder, yeasts, etc.
Trigger handle mechanism

Inox



20 orificios/pulgada · 20 eyes/inch

Cribador de harina INOX

Tamis · Mehlsieb
Flour sifter · Crivador de farinha

Ref	€	Ø (cm)	Kg	U.Venta
67011	10,60	10,0	0,35	5
67015	14,10	12,0	0,50	1

AS plastic BPA free



Cribador de harina

Tamis · Mehlsieb
Flour sifter · Crivador de farinha

Ref	€	Ø (cm)	Kg	U.Venta
67025	7,20	10	0,35	6

BATIDORES

Colección

Inox
18/10
Dishwasher



Inox



Batidor MINI

Mini fouet Inox · Mini-Schneebeesen
Mini whisk · Mini batedor Inóx

Ref	€	L (cm)	U.Venta
61615	5,40	15	12
61620	6,00	20	12



Batidor EXTRA 8

Fouet inox extra 8 · Schneebeesen, Extra 8
Extra 8 whisk · Batedor Extra 8

Ref	€	L (cm)	U.Venta
61625	8,50	25	6
61630	8,70	30	6
61635	9,10	35	6
61640	10,00	40	6
61645	10,80	45	6
61650	12,10	50	6
61655	12,80	55	6
61660	13,80	60	6



Batidor SUPER 12

Fouet inox super 12 · Schneebeesen, super 12
Super 12 whisk · Batedor Super 12

Ref	€	L (cm)	U.Venta
61626	7,80	25	6
61631	8,40	30	6
61636	9,10	35	6
61641	9,60	40	6
61646	9,90	45	6
61651	10,80	50	6

Si
Silicone
250
°C
BPA free

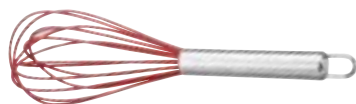

Batidor varilla silicona

Fouet en silicone · Ruhrbesen auf Silikon
Silicone wire whisk · Batedor vareta silicone

Ref	€	L (cm)	U.Venta
61621	8,00	20	12
61622	8,90	25	6
61623	9,90	30	12



Batidor gigante

Fouet à purée · Kesselbesen
Big whisk · Batedor gigante

Ref.	€	cm	Ø Varilla (mm)	U.Venta
60610	62,40	100	3	12
60612	80,00	129	3	12

Si
Silicone
LFGB
BPA free

A



Mango de Haya natural
Natural beech handle

B



Batidor varilla con espátula

Fouet avec grattoir · Schneebeesen mit Schaber
Whisk with spatula · Batedeira de varas com espátula

	Ref	€	L (cm)	U.Venta
A	68199	5,90	27,0	1
B	61627	6,20	32,0	12

- Indeformable. Varillas de acero inoxidable 18/10. Mango de fibra de vidrio resistente.
- Ideal para batir crema de leche, huevos, claras a puntode nieve, masas ligeras, cremas, etc.

- Indéformable. Tiges en acier inoxydable 18/10. Manche en fibre de verre durable.
- Idéal pour fouetter la crème, les œufs, les blancs d'œufs, les pâtes légères, les crèmes, etc.

- Non-deformable. 18/10 stainless steel rods. Durable fibreglass handle.
- Ideal for whipping cream, eggs, egg whites, egg whites, light doughs, creams, etc.

Si
Silicone
250
°C
BPA free



Batidor FIBREGLASS

Fouet · Schneebeesen
Whisk · Batedores

Ref	€	L (cm)	U.Venta
61624	11,80	25	6
61629	13,60	30	6
61634	15,40	35	6
61639	17,00	40	6
61644	20,40	45	6
61649	21,40	50	6



Batidor silicona FIBREGLASS

Fouet en silicone · Schneebeesen, Silikon
Silicone whisk · Batedores silicona

Ref	€	L (cm)	U.Venta
61524	10,80	25	6
61529	11,70	30	6
61534	13,60	35	6



Mango ergonómico
Ergonomic handle

Batidor FIBREGLASS

Fouet · Schneebeesen
Whisk · Batedores

Ref	€	L (cm)	U.Venta
61590	10,80	25	6
61591	11,70	30	6
61592	13,60	35	6

New

- Especial para preparar comidas que no contengan alérgenos.

- Spécialement pour la préparation de repas ne contenant pas d'allergènes.
- Specially for preparing meals that do not contain allergens.

Inox



Batidor manivela

Batteur-mélangeur à manivelle · Schneequirl
Egg beater · Batedor de manivela

Ref	€	U.Venta
62901	19,10	6



Batidor capuccino

Batteur pour cappuccino · Capuccino- Mixer
Capuccino mixer · Batedor capuccino

Ref	€	W	U.Venta
69041	26,70	2,7	1

ESPÁTULAS SILICONA

Colección



ES

- Fabricados en silicona de alta calidad libre de BPA.
- Núcleo reforzado para una mayor resistencia sin perder flexibilidad en los bordes. Diseñados en una sola pieza, sin costuras ni grietas.
- Resistentes a altas temperaturas.
- Mango ergonómico suave al tacto y antideslizante.
- No rayan ni dañan artículos de cocina con antiadherente.
- Fáciles de limpiar. Aptas para el lavavajillas.

FR

- Fabriqué en silicone de haute qualité sans BPA.
- Noyau renforcé pour une résistance accrue sans perte de flexibilité des bords. Conception monobloc, sans coutures ni fissures.
- Résistant aux hautes températures.
- Poignée ergonomique, douce au toucher et antidérapante.
- Ne raye pas et n'endommage pas les ustensiles de cuisine antiadhésifs.
- Facile à nettoyer. Lavable au lave-vaisselle.

EN

- Made of high quality BPA free silicone.
- Reinforced core improves strength without losing flexibility around the edges. Designed in a single piece without seams or cracks.
- Can withstand high temperatures.
- Soft and non-slip ergonomic handle.
- Does not scratch cooking utensils with non-stick coating.
- Easy to clean. Dishwasher safe.



Utensilios GREY

Ustensiles en silicone · Silikonutensilien
Silicone utensils · Utensílios de silicone

	Ref	€	L (cm)	U.Venta
	64459	15,60	27,5	1
A	64463	5,50	27,5	1
B	64464	5,50	27,5	1
C	64465	5,60	27,5	1

Utensilios OCEAN

Ustensiles en silicone · Silikonutensilien
Silicone utensils · Utensílios de silicone

	Ref	€	L (cm)	U.Venta
	64452	16,70	27,5	1
	64453	5,80	27,5	1
	64454	5,80	27,5	1
	64455	5,80	27,5	1

Set 3 utensilios · Set 3 utensils

Cuchara · Spoon

Espátula · Spatula

Pincel · Brush



Espátula silicona

Spatule en silicone · Teigschaber
Silicone spatula · Espátula de silicone

	Ref	€	L (cm)	U.Venta
A	64444	5,90	28	1
B	64445	6,60	30	1
C	64446	6,70	31	1



Mango de polipropileno
Polypropylene handle

Espátula silicona

Spatule en silicone · Teigschaber
Silicone spatula · Espátula de silicone

	Ref	€	L (cm)	U.Venta
	67421	4,60	20	1
A	67427	6,80	26	1
	67433	14,90	32	1
B	67434	4,70	30	12
	67435	5,40	29	12

Espátula UNITE

Spatule · Backschauffel
Spatule · Espátula

	Ref	€	cm	L (cm)	U.Venta
	68195	4,30	5,6x8,5	26,5	1

Espátula silicona

Spatule en silicone · Teigschaber
Silicone spatula · Espátula de silicone

	Ref	€	L (cm)	U.Venta
	64450	5,60	25	6
A	64451	8,90	35	6
	64460	5,80	25	6
B	64461	9,70	35	6

New

Espátula para tarros

Spatule pour pots · Spatel für Einmachgläser
Jar spatula · Espátula para frascos

	Ref.	€	cm	L (cm)	U.Venta
A	64490	2,40	3,8x8,4	25	1
B	64491	4,00	4,8x10,8	35	1



- Fabricada en silicona y ABS de alta calidad, libre de BPA.
- Resistente a altas temperaturas.
- Cabezal flexible y maleable. No raya ni daña artículos de cocina con antiadherente.
- Diseñada especialmente para rebañar tarros a la perfección, aprovechando hasta lo último de mermeladas, mayonesas, salsas, etc.
- Higiénica. Fácil de limpiar. Apta para el lavavajillas.

- Fabriqué en silicone et ABS de haute qualité sans BPA.
- Résistant aux températures extrêmes.
- Tête flexibilité et malléabilité. Ne raye pas et n'endommage pas les ustensiles de cuisine antiadhésifs.
- Spécialement conçue pour racler les pots à la perfection, récupérant ainsi les dernières gouttes de confiture, mayonnaise, sauce, etc.
- Hygiénique. Faciles à nettoyer. Lavable au lave-vaisselle

- Made of high quality BPA free silicone and ABS.
- Resistant to extreme temperatures.
- Flexible and malleable head. Does not scratch cooking utensils with non-stick coating.
- It's specially designed for scraping all kinds of jars to perfection, so you can enjoy every last bit of your marmalade, mayonnaise or sauce, etc.
- Hygienic. Easy to clean. Dishwasher safe.

Set repostería (20 pcs.)

Exposant pâtisserie · Aufsteller Pastry
Pastry display · Expositor pasteleria

	Ref	€	L (cm)	Pieza	U.Venta
A	64424	78,30	-	Caja (20 pcs.) / Set (20 pcs.)	1
B	64426	4,00	23,0	Pincel / Brush	12
C	64427	4,00	23,0	Espátula / Spatula	12
D	64428	4,00	23,0	Lengua gato / Spatula	12
E	64429	4,00	23,0	Batidor / Whisk	12



New

Espátula profesional EXTRAplana

Spatula professionnelle · Profi-Spachtel
Professional spatula · Espátula profesional

	Ref	€	L (cm)	U.Venta
A	61373	5,50	30	1
B	61375	6,00	35	1
C	61374	7,30	40	1



- Espátula extraplana fabricada en nylon y fibra de vidrio especialmente diseñada para uso profesional.
- Sólida e indeformable. Resistente a altas temperaturas.
- No absorbe olores ni sabores.
- Apta para el lavavajillas.

- Spatule extra plate fabriquée en nylon et fibre de verre spécialement conçue pour un usage professionnel.
- Résistante aux hautes températures.
- Solide et indéformable. N'absorbe ni les odeurs ni les goûts.
- Apte pour le lave-vaisselle.

- Super thin, glass fibre nylon spatula, specially designed for professional use.
- High temperature resistant.
- Robust and non-deformable.
- Does not absorb smells or flavours.
- Dishwasher safe.

PINCELES

Colección

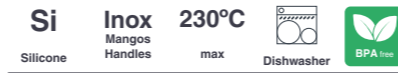

ES

- Para cocina o repostería.
- Prácticas espátulas o lenguas de gato para rebañar boles, cazuelas, fuentes, etc.
- Pinceles ideales para pincelar con aceites o salsas, marinar carnes o pescados, engrasar moldes, untar con aceite, huevo batido, almíbar, etc.
- No absorben olores ni sabores.

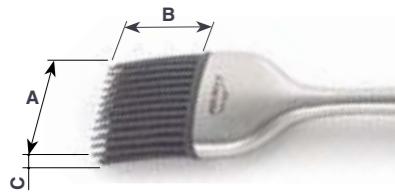

Mango de polipropileno
Polypropylene handle



Pincel VIROLA
Pinceau · Silikonpinsel
Brush · Pincel

Ref	€	A (cm)	B (cm)	C (cm)	L (cm)	U.Venta
64430	4,30	2,8	5,0	5,0	23,0	1
64435	5,00	3,2	5,5	7,0	24,0	1
64440	5,20	3,8	5,5	7,0	24,5	1
65044	6,40	4,2	6,5	8,0	25,0	1
65050	7,70	4,7	6,5	8,0	26,0	1

Dimensiones reales · Real dimensions

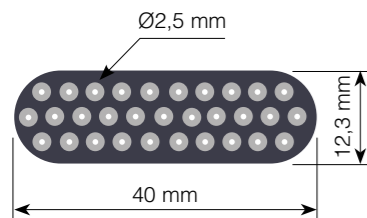

Pincel de silicona MIX
Pinceau de cuisine en silicone · Silikonpinsel
Silicone brush · Pincel de silicone

Ref	€	A (cm)	B (cm)	C (cm)	L (cm)	U.Venta
64431	7,20	3,8	4,0	1,0	24	12

FR

- Pour la cuisine ou la pâtisserie.
- Pratiques spatules ou langues de chats pour récupérer les éléments restant dans les bols, casseroles, etc.
- Pinceaux parfaits pour badigeonner de l'huile ou des sauces, mariner des viandes ou des poissons, graisser des moules, étaler de l'huile, de l'œuf battu, du sirop, etc.
- N'absorbent ni les odeurs ni les goûts.

EN

- For cooking or baking.
- Practical spatulas for scraping bowls, pots, dishes, etc.
- Brushes ideal for brushing oils or sauces, marinating meat or fish, greasing baking tins, and basting with oil, egg, syrup, etc.
- Doesn't absorb smells or tastes.



Inox
18/10

Pincel de silicona PRO
Pinceau en silicone · Silikonpinsel
Silicon brush · Pincel silicone

Ref	€	A (cm)	B (cm)	C (cm)	L (cm)	U.Venta
64418	10,80	4,0	4,0	1,4	22	1
64422	12,10	4,0	4,0	1,4	23	1



Pincel de silicona
Pinceau en silicone · Silikonpinsel
Silicon brush · Pincel de silicone

Ref	€	A (cm)	B (cm)	C (cm)	L (cm)	U.Venta
64441	6,70	5,8	3,4	1,7	23	1

Mango de Haya natural
Natural beech handle



Pincel UNITE
Pinceau · Silikonpinsel
Brush · Pincel

Ref	€	A (cm)	B (cm)	C (cm)	L (cm)	U.Venta
68196	4,10	5,5	3,1	1,1	24,5	1

RASQUETAS

Colección



Diseño apilable
Stackable design

Rasqueta
Coupe pate · Schaber
Scraper · Raspador

Ref	€	cm	U.Venta
67041	25,10	13,8x13	1

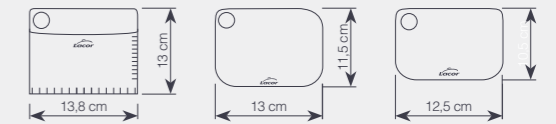

· El cortador de masa está fabricado en acero inoxidable de máxima calidad con escalas de medición tanto en cm como en in. Además, dispone de un mango antideslizante y ergonómico. Está diseñado para cortar, dividir y formar masas, así como recoger harinas, etc.

· Espátula de silicona exible de gran calidad y grado alimenticio. Ideal para el empleo en superficies poco uniformes, como boles esféricos.

· El raspador está fabricado en Polipropileno + Fibra de vidrio de grado alimenticio y diseñado principalmente para decorar tartas y pasteles de forma práctica y sencilla.

· Dough cutter made of top quality stainless steel with measurements marked in cm and inches. It has a non-slip ergonomic handle. It's designed to cut, divide and shape dough or pick up flour, etc.

· High quality flexible food safe silicone spatula, perfect for using on uneven surfaces like spherical bowls.

· Scraper made of food grade Polypropylene + Glass fiber mainly designed for decorating cakes and pies in a simple and easy way.



Escala de medición
Measurement scale

Rasqueta INOX
Coupe pate · Schaber
Scraper · Raspador

Ref	€	cm	U.Venta
A 67005	12,80	15x9	6
B 67006	12,40	15x9	6

Rasqueta INOX BLAK
Coupe pate · Schaber
Scraper · Raspador

Ref	€	cm	U.Venta
67029	9,40	16,5x10,5	6



Rasqueta FLEX
Coupe pate · Schaber
Scraper · Raspador

Ref	€	cm	U.Venta
67414	8,90	9x15	1

RODILLOS

Colección

Inox 18/10 



(A) LONGITUD TOTAL - Total length
(B) LONGITUD ZONA DE USO - Length area of use

ES

- Ideal para extender pequeñas cantidades de masa.
- Acabado uniforme para trabajar pastas, mazapán, fondant, etc.

FR

- Idéal pour étaler de petites quantités de pâte.
- Finition uniforme pour travailler des pâtes, du massepain, des fondants, etc.

EN

- Perfect for spreading small quantities of dough.
- Uniform nish when working with pastries, marzipan, fondant, etc.

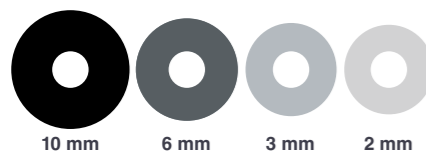

4 discos extraíbles · 4 removable discs

Guía para medir el ancho de la masa
Guide to measure the width of the dough



Rodillo amasar con anillas

Rouleau hêtre avec anneux · Teigroller mit Ringen
Rolling pin with guide rings · Rolo com anilhas

Ref	€	Anillas	L (cm)	Material	U.Venta
A 67142	15,30	10/6/2	38	HAYA	1
B 67143	15,90	10/6/3/2	38	INOX	1



Rodillo

Rouleau patisier · Teigroller
Rolling pin · Rolo

Ref	€	A (cm)	ØCxB (cm)	U.Venta
67140	42,00	40	Ø5x20	3
67148	46,80	48	Ø6,3x25	4
67156	50,00	56	Ø6,3x33	4
A 67149	48,60	48	Ø6,3x25	4
68153	11,00	50	30	1
68154	20,80	60	40	1
68142	9,70	43	Ø4,4	1
68150	10,20	50	Ø4,8	1
68141	35,60	43	Ø4,4	1
E 68151	43,50	50	Ø4,8	1

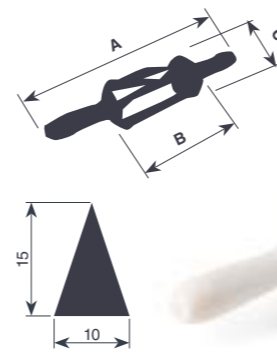

Rodillo cortador croissant

Rouleau pour coupe croissant · Schneidewalze für Croissantteig
Croissant dough cutter wheel · Rolo cortador de croissants

Ref	€	A (cm)	B (cm)	C (Ø cm)	U.Venta
68161	33,40	40,5	15,3	7,7	1



Rodillo picar pasta

Rouleau pique vite pointe metal · Teig-Gitterschneider
Roller docker metal · Rolo de picar massas

Ref	€	L (cm)	U.Venta
68213	36,40	13	6

New



ABS plastic PP Polypropylene

Rodillo ROLLER

Rouleau patisier · Teigroller
Rolling pin · Rolo

Ref	€	cm	L (cm)	U.Venta
A 68801	6,10	14	19,5	1
B 68802	6,10	14	19,5	1
C 68803	6,10	14	19,5	1
D 68804	6,10	12	19,5	1

- 68801: Corta con rapidez y precisión tiras de masa lisas y uniformes. Gracias a sus 9 ruedas extraíbles, podrás ajustar la anchura deseada.
- 68802: Diseñado para perforar cualquier tipo de masa (pasteles, quiches, hojaldres, pizza, etc.) Evita la formación de burbujas en las bases de masa durante el horneado.
- 68803: Corta con rapidez y precisión tiras de masa onduladas y uniformes. Gracias a sus 9 ruedas extraíbles, podrás ajustar la anchura deseada.
- 68804: Diseñado para formar una rejilla uniforme de pasta. Efecto simétrico enrejado, ideal para empanadas, pasteles de manzana, hojaldres, etc.
- Mango ergonómico
- Diseñado para todo tipo de masas. Deja volar tu imaginación.
- Mango ergonómico.
- Fácil limpieza, 100% desmontable y apto para el lavavajillas.
- Material: ABS y mango de polipropileno. Libre de BPA.

- 68801 : Coupez avec rapidité et précision des bandes de pâte lisses et uniformes. Grâce à ses 9 roulettes amovibles, vous pourrez régler la largeur souhaitée.
- 68802 : Conçu pour piquer tout type de pâte (tartes, quiches, feuilletés, pizza, etc.). Évite la formation de bulles sur la base des pâtes pendant la cuisson.
- 68803 : Coupez avec rapidité et précision des bandes de pâtes ondulées et uniformes. Grâce à ses 9 roulettes amovibles, vous pourrez régler la largeur souhaitée.
- 68804 : Conçu pour faire un dessus de treillis de pâte uniforme. Effet symétrique de losanges, idéal pour des empanadas, des tartes aux pommes, des feuilletés, etc.
- Conçu pour tout type de pâtes. Laissez libre cours à votre imagination.
- Manche ergonomique.
- Nettoyage facile, 100% démontable et apte pour le lave-vaisselle.
- Matériau : ABS et manche en polypropylène. Sans BPA.

- 68801 : Quickly and accurately cuts smooth, even strips of dough. 9 removable cutting wheels allow you to adjust the desired width.
- 68802 : Designed for poking holes (also referred to as 'docking') in any type of dough (cakes, quiches, puff pastry, pizza, etc.). Prevents formation of air bubbles in dough bases during baking.
- 68803 : Quickly and accurately cuts uniform strips of dough into waves. 9 removable cutting wheels allow you to adjust the desired width
- 68804 : Designed for creating a uniform lattice pattern. Symmetrical lattice effect, ideal for pastries, apple pies, puff pastry, etc.
- Designed for all types of dough. Let your imagination run wild!
- Ergonomic handle.
- Easy to clean, fully detachable and dishwasher safe.
- Material: ABS with polypropylene handle. BPA free



SET CORTADORES

Colección



Medidas - Sizes (cm):
Ø2 / Ø3 / Ø4 / Ø5 / Ø6 / Ø7 / Ø8 / Ø9 / Ø10

Caja de 9 cortapastas redondos

Boîte de 9 découpeurs ronds unis - 9 Tlg. Teigausstecher, rund, glatt
Set of 9 round dough cutters - Caixa de 9 corta-massas ovais redondos

Ref	€	h (cm)	U.Venta	
68069	27,70	4,2	1	Liso - Pain
68070	30,10	4,2	1	Rizado - Fluted
68091	25,10	3,5	1	Liso - Pain
68092	25,10	3,5	1	Rizado - Fluted

- Set compuesto por 9 cortapastas redondos de Ø2-3-4-5-6-7-8-9-10 cm.
- Fabricados en acero inoxidable 18/10 de gran calidad.
- Ideales para repostería (pasteles, muffins, galletas, fondant, pan, gelatina, pancake, etc.).
- Aseguran un corte 100% preciso y seguro.
- Versátiles: se pueden usar como moldes para hojaldres o decoración de platos.
- Aptos para el lavavajillas.

- Ensemble de 9 découpeurs ronds Ø2-3-4-5-6-7-8-9-10 cm.
- Fabriqués en acier inoxydable 18/10 de haute qualité.
- Idéal pour la pâtisserie (gâteaux, muffins, biscuits, fondant, pain, gelée, crêpes, etc.)
- Ils garantissent une coupe précise et sûre à 100 %.
- Polyvalents : peuvent être utilisés comme moules pour la pâte feuilletée ou pour la décoration d'assiettes.
- Passent au lave-vaisselle.

- Set of 9 round dough cutters Ø2-3-4-5-6-7-8-9-10 cm.
- Made of high-quality 18/10 stainless steel.
- Ideal for baking (cakes, muffins, biscuits, fondant, bread, jelly, pancake, etc.).
- They ensure 100% accurate and safe cutting.
- Versatile: can be used as moulds for puff pastry or plate decoration.
- Dishwasher safe

Cerrado - Closed: 5,5x24 cm
Abierto - Open: 49,5x24 cm
Cuchillas - Blades: Ø5,5 cm

Cortapastas extensible
Rouleau multicouper - Teigschneider
Dough divider expandable - Corta-massas extensível

Ref	€	U.Venta
68246	51,10	1



New



Set cortartas
Jeu de découpeurs de gâteaux - Tortenausstecher-Set
Cake cutter set - Conjunto de cortador de bolos

Ref	€	Ø (cm)	Ranuras	U.Venta
68527	13,90	24 - 30	6	1

- Set de tres utensilios para laminar todo tipo de tartas, bizcochos, etc.
- Fabricados en acero inoxidable de gran calidad. Resistentes y duraderos.
- El set incluye:
 - * Aro ajustable con 6 ranuras que actúan de guía para cortar uniformemente tartas entre Ø 24-30 cm.
 - * Cuchillo de hoja dentada diseñado para laminar fácilmente.
 - * Pala para coger y servir de forma segura.

- Set de trois ustensiles pour laminer tous types de gâteaux, gâteaux, etc.
- Fabriqués en acier inoxydable de grande qualité. Résistants et durables.
- Le set inclut :
 - * Cercle ajustable avec 6 rainures qui font office de guide pour découper uniformément les gâteaux de Ø 24-30 cm.
 - * Couteau à lame dentée conçu pour laminer facilement.
 - * Pelle à gâteau pour prendre la part et servir de façon sûre.

- Set of three utensils for layering all kinds of cakes.
- Made of high quality stainless steel, it is strong and durable.
- The set includes:
 - * Adjustable ring with 6 grooves that work as guides for cutting cakes between Ø 24-30 cm.
 - * Serrated knife designed to cut layers easily.
 - * Spatula for picking up and serving the cake safely.



Incluye cortapastas
Includes cookie cutter



Sellos para galletas SWEET

Tampons pour biscuits - Keksstempel
Biscuit stamp - Carimbo para bolachas

Ref	€	Sellos	U.Venta
68099	13,20	5	1

Dale un toque original - Add originality



- Conjunto de 5 originales sellos de silicona intercambiables.
- Mango de madera para un perfecto agarre.
- Silicona de máxima calidad. Libre de BPA.
- Garantiza la completa seguridad alimentaria del producto.

- Set de 5 tampons en silicona originaux interchangeables.
- Manche en bois pour une prise en main parfaite.
- Silicone de la plus grande qualité. Sans BPA.
- Garantit une sécurité alimentaire totale du produit.

- Set of 5 original interchangeable silicon stamp.
- Wood handle for perfect grip.



ATEMPERAR

Espátula



New

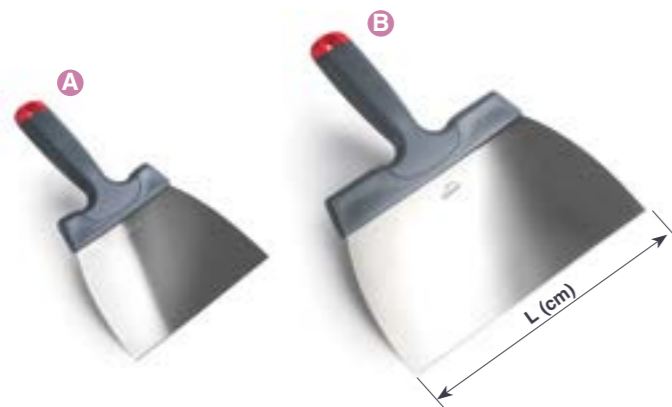

Espátula para atemperar chocolate

Spatule pour tempérer le chocolat · Spatel zum Temperieren von Schokolade
Chocolate tempering spatula · Espátula para temperar chocolate

	Ref	€	L (cm)	U.Venta
A	60533	6,80	16	1
B	60534	7,40	22	1

- Espátula profesional de acero inoxidable de máxima calidad, de grado alimenticio, resistente y duradero.
- Diseñado para templar chocolate recién fundido, glasear pasteles, galletas, pizzas, etc.
- Hoja superafilada trapezoidal semiflexible de 16 cm de ancho.
- Mango ergonómico y resistente, con orificio colgante.

- Spatule professionnelle en acier inoxydable de la plus grande qualité, à usage alimentaire, résistante et durable.
- Conçue pour le tempérage du chocolat fraîchement fondu, le glaçage des gâteaux, biscuits, pour les pizzas, etc.
- Feuille très aiguisée semi-flexible de 16 cm de largeur.
- Manche ergonomique et résistant, avec œillet de suspension.

- Professional spatula made of high quality, food-grade stainless steel, strong and durable.
- Designed for tempering freshly melted chocolate, glazing cakes, biscuits, pizzas, etc.
- Super-sharp, semi-flexible 16 cm wide trapezoidal blade.
- Sturdy, ergonomic handle with hanging hole.



DECORACIÓN

Peines · Estacas



Rasqueta decoración

Grattoir à pâte · Teigschaber
Dough scrape · Raspador de masa

Ref	€	mm	U.Venta
68132	1,70	155x105	24



Peine decoración

Peigne du decoration · Verzierungskamm
Decorating comb · Pente de decoração

Ref	€	mm	U.Venta
68136	1,50	110	24



Juego peines decoración

Set peigne du decoration · Verzierungskamm-Set
Decorating comb set · Jogo pente de decoração

Ref	€	Piezas	U.Venta
68137	5,80	7	1



ABS plastic

Estacas decoración FONDANT

Outils de modelisation · Modellerset
Modeling tools · Ferramentas demodelagen

Ref	€	Piezas	U.Venta
68090	11,20	12	1

DECORACIÓN

Aerógrafo con compresor



ES

- Ideal para la decoración de tartas, galletas, cupcakes, bombones, etc.
- Permite obtener detalles únicos en creaciones artísticas de repostería.
- El kit contiene: compresor, aerógrafo y tubo conector.
- Compresor con regulador de presión de aire.
- 0-2 bares y con un caudal de 0-10 L/min.
- Aerógrafo por gravedad de doble acción con aguja de salida de 0,3 mm.
- Depósito de pintura metálico con capacidad de 7 ml.
- Incluye una caja acolchada para almacenar el aerógrafo.

FR

- Idéal pour la décoration de gâteaux, biscuits, cupcakes, chocolats, etc.
- Permet d'obtenir des détails uniques sur des créations artistiques de pâtisserie.
- Le kit contient : compresseur, aérographe et tuyau connecteur.
- Compresseur avec régulateur de pression d'air.
- 0-2 bars et avec un débit de 0-10 L/min.
- Aérographe par gravité à double action avec aiguille de sortie de 0,3 mm.
- Réservoir de peinture métallique d'une capacité de 7 ml.
- Inclut une boîte matelassée pour ranger l'aérographe.

EN

- Perfect for decorating cakes, biscuits, cupcakes, bonbons, etc.
- Lets you get unique details on artistic bakery creations.
- The set contains: Compressor, airbrush and air hose.
- Compressor with air pressure regulator.
- 0-2 bars with a 0-10 L/min flow.
- Double action gravity feed airbrush with a 0.3 mm needle.
- Metal paint cup with a 7 ml capacity.
- Includes a padded box for storing the airbrush.



Características · Characteristics:

Referencia · Reference: 69450
Tensión · Voltage: 220-240 V; 50 Hz
Potencia · Power: 20 W
Presión · Pressure: 0 - 2 bar
Caudal aire · Air flow: 0 - 10 L7min
Capacidad · Capacity: 7 ml
L tubo · tube: 1,80 m
Aerógrafo · Airbrush: 14,2x2,5x9 cm
Compresor · Compressor: 11,5x13,5x6 cm
Peso · Weight: 800 g

Aerógrafo con compresor

Aérographe avec compresseur · Airbrush Spritzpistole mit Kompressor
Airbrush with compressor · Aerógrafo com compressor

Ref	€	W	Presión	Caudal	U.Venta
69450	103,20	20	0 - 2 bar	0 - 10 L/min	1



PISTOLAS · SOPLETES GAS

Colección

Inox 18/10 CE



ES

- Autoencendido por piezoeléctrico.
- Control ajustable de llama.
- Llama antiretorno.
- Sistema seguro de bloqueo.
- Fácil rellenado de gas butano.

FR

- Auto-allumage par piézoélectrique.
- Contrôle de flamme réglable.
- Flamme antiretour.
- Système de blocage sécurisé.
- Facile remplissage de gaz butane.

EN

- Auto power by piezoelectric sensor.
- Adjustable flame control.
- Non-return flame.
- Safe stop system.
- Easy filling of butane gas.



Válvula recarga gas
Refill valve



Pistola gas repostería

Torche à caraméliser · Gasbrenner
Pastry gas torch · Queimadora a gás para pastelaria

	Ref	€	Cap. (ml)	h (cm)	U.Venta	
A	68981	18,90	5-6	12,50	1	Micro
B	68982	30,70	19	17,00	1	Mini
C	68983	41,80	65	18,00	1	Chef
D	68988	53,20	40	16,00	1	Profesional
E	68969	22,10	21	13,00	1	Burn

Cuando el orificio de entrada de oxígeno este descubierto, la llama será más intensa

When the oxygen inlet is uncovered, the flame will be more intense



Adaptador para poder utilizar distintos tipos de botellas de gas
Adapter enables it to be used with different types of gas bottles



Botella de gas NO incluida
Gas of bottle NOT included

Cabezal soplete gas + adaptador PROFESIONAL

Torche à caraméliser + adaptateur · Gasbrenner-Aufsatz + Adapter
Blow torch head + adapter · Queimadora a gás + adaptador

Ref	€	W	Consumo (g/h)	U.Venta
68974	25,20	1,65	120	1



Botella de gas NO incluida
Gas of bottle NOT included

Cabezal soplete gas PROFESIONAL

Torche à caraméliser · Gasbrenner-Aufsatz
Blow torch head · Queimadora a gás

Ref	€	W	Consumo (g/h)	U.Venta
68984	16,30	1,65	120	1



GAS
No incluido
Not included

Válido para gas butano, NO gas natural
Valid for butane gas, NOT natural gas

Soplete gas PROFESIONAL

Torche à caraméliser · Brullierbrenen
Blow torch · Queimador a gás

Ref	€	Kw	Temp.	g/h	U.Venta
68968	31,00	1,7	1300°C	123	1



Incluye soporte
Includes support

Queimador eléctrico redondo

Fer à caraméliser électrique rond · Karamellisierer rund
Round electric caramelizer · Queimador eléctrico redondo

Ref	€	U.Venta
68651	114,70	1
68652	132,40	1

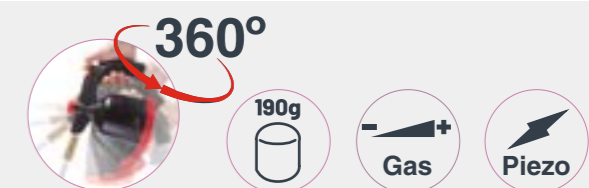

- Recargable con cartuchos universales de gas tipo C200 (190g). (No incluido).
- Encendido piezoeléctrico.
- Flujo ajustable.
- Función de precalentamiento integrada que garantiza una configuración de llama óptima.
- Sistema 360°; permite el uso en cualquier posición y siempre con llama constante.
- Sistema de bloqueo de seguridad.
- Mango ergonómico de polipropileno resistente a altas temperaturas y golpes.

- Refillable with universal type C200 (190 g) gas cartridges (not included).
- Piezoelectric ignition.
- Adjustable flow.
- Built in pre-heating function that guarantees optimal flame configuration.
- The 360° System lets you use the torch in any position and always with a constant flame.
- Safety locking system.
- Ergonomic polypropylene handle that can withstand high temperatures and impacts.

- Fabricada en acero inoxidable 18/10 con mango de plástico negro de excelente calidad.
- Diseñado para aplicaciones en cocina y repostería.
- Consta de una resistencia, que al conectarse a la corriente, se calienta.
- Incluye soporte.

- Made of 18/10 stainless steel with a high quality black plastic handle.
- Designed for cooking and baking applications.
- Consists of a heating element, which heats up when connected to the mains.
- Includes stand

Características · Characteristics:

Referencia · Reference: 68651
Tensión · Voltage: 220-230 V; 50 Hz
Potencia · Power: 650 W
Dimensiones · Sizes: Ø10 cm
Peso · Weight: 1,132 Kg

Referencia · Reference: 68652
Tensión · Voltage: 220-230 V; 50 Hz
Potencia · Power: 1000 W
Dimensiones · Sizes: Ø12 cm
Peso · Weight: 1,268 Kg

DOSIFICADORES

Colección

Inox
18/10
Dishwasher



Salado · Salty



Dulce · Sweet

ES

- Ideal para rellenar o decorar platos con salsas y cremas calientes y frías.
- Sistema de palanca para un caudal ajustable; práctico y preciso.
- Sistema antigoteo y antisalpicaduras.
- Mango con diseño ergonómico que permite el manejo con una sola mano.
- Fácil desmontaje para una sencilla limpieza. Apto para el lavavajillas.

FR

- Idéal pour remplir ou décorer des assiettes avec des sauces chaudes et froides.
- Système de piston pour un débit ajustable ; pratique et précis.
- Système anti-goutte et anti-éclaboussures.
- Manche ergonomique qui permet de le manipuler d'une seule main.
- Facile à démonter pour un nettoyage aisé, et apte pour le lave-vaisselle.

EN

- Perfect for filling or decorating dishes with hot or cold sauces and cream.
- Its lever system for controlling the flow is practical and precise.
- Anti-drip and anti-splash system.
- The ergonomic handle means it can be used with just one hand.
- It's easy to disassemble for easy cleaning and it's dishwasher safe.

Si PS BPA free



Marcas de medición
(ml - cup)
Measuring marks
(ml - cup)

Dosificador

Entonnoir à decor · Dosierer
Portionner · Dosificador

Ref	€	cm	h (cm)	L	U.Venta
67026	11,80	16x11	18	1,0	1



Incluye soporte y un platillo antigoteo
Includes support and a drip dish

Dosificador INOX

Entonnoir à decor · Dosierer
Portionner · Dosificador

Ref	€	Ø (cm)	h (cm)	L	U.Venta
67150	61,60	19	27	2,0	1
R67150B	19,90	4/6/8			1

Set 3 boquillas
Set 3 nozzles



Salado · Salty



Dulce · Sweet

Sistema de gatillo para un caudal ajustable
Trigger system for an adjustable flow



3 Boquillas
Nozzles

Dosificador RATION

Entonnoir à decor · Dosierer
Portionner · Dosificador

Ref.	€	L	U.Venta
67000	88,60	2,00	1



Cono

Cône · Trichter
Cone · Cone

Ref.	€	L	U.Venta
R67000	39,30	2,00	1

Diseño premiado en certámenes internacionales
Award-winning design in international competitions

ASA Acrylic BPA free



Soporte mango

Support · Stütze
Support · Suporte cabo

Ref.	€	U.Venta
R67001	35,40	1



Base negra

Base noire · Ständer, schwarz
Black base · Base negra

Ref.	€	U.Venta
R67002	13,90	1



Boquillas

Douille · Düse
Nozzle · Boquilhas

	Ref.	€	Ø (mm)	U.Venta
A	R67003	1,60	1	1
B	R67004	1,80	4	1
C	R67005	1,80	6	1
D	R67006	1,80	8	1

SIFONES

Colección

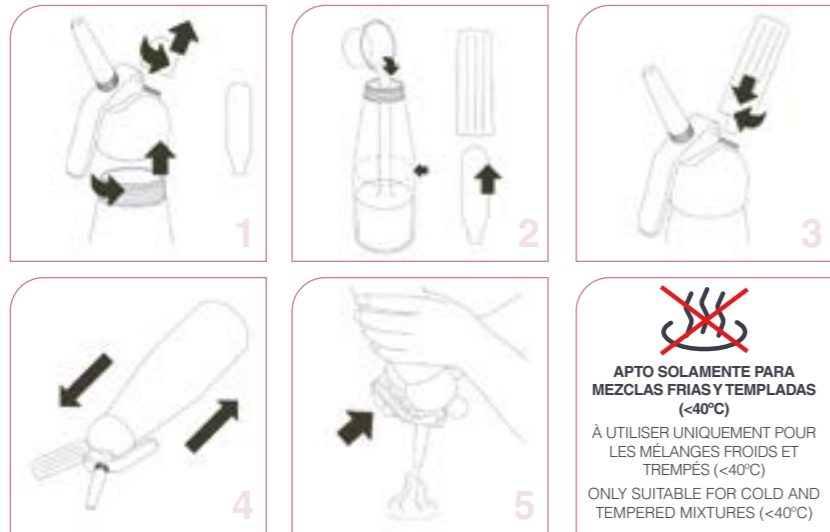

EXCLUSIVAMENTE PARA USO ALIMENTICIO
EXCLUSIVELY FOR FOOD USE



Cargas sifón N2O

Cartouches N₂O pour siphon · N₂O Kapsel für Sahnbereiter
N₂O cream charger · Botijas de sifão N₂O

Ref	€	Botellas	g	U.Venta
68402	8,30	10	8	1
68403	19,40	24	8	1

APTO SOLAMENTE PARA MEZCLAS FRIAS Y TEMPLADAS (<40°C)
À UTILISER UNIQUEMENT POUR LES MÉLANGES FROIDS ET TREPÉS (<40°C)
ONLY SUITABLE FOR COLD AND TEMPERED MIXTURES (<40°C)

New

Sifón EPICURE

Siphon à crème · Sahnebereite
Cream whipper · Sifão creme

Ref	€	Ø (cm)	L	U.Venta
68300	104,70	9,0	0,50	1
68301	118,90	9,0	1,00	1

Temperatura de uso · Use temperature
min = +5°C / max = +70°C



- Cuerpo y cabezal fabricado en acero inoxidable 18/10 de gran calidad.
- Marcaje de llenado grabado en el exterior del cuerpo.
- Versátil: Diseñado para espumas frías y espumas calientes.
- Incluye 3 boquillas de acero inoxidable con formas decorativas.
- Funciona con cargas de gas (N₂O).
- Cepillo limpiador para facilitar la limpieza. Apto para el lavavajillas.

- Corps et tête fabriqués en acier inoxydable 18/10 de grande qualité.
- Marquage de remplissage gravé à l'extérieur du corps.
- Versatile : conçu pour des préparations froides et chaudes.
- Inclut 3 douilles en acier inoxydable avec des formes décoratives.
- Fonctionne avec des cartouches de gaz (N₂O).
- Brosse pour faciliter le nettoyage. Compatible avec le lave-vaisselle.

- Top-quality 18/10 stainless steel body and head.
- Embossed filling marks on the outside.
- Versatile: designed for whipping up hot or cold foams.
- Includes 3 stainless steel nozzles with decorative shapes.
- Charged with gas cartridges (N₂O).
- Cleaning brush for easy cleaning. Dishwasher safe.



Sifón MIX

Siphon à crème · Sahnebereite
Cream whipper · Sifão creme

Ref	€	Ø (cm)	L	U.Venta
68404	100,00	7,8x25	0,50	1
68405	114,90	9,3x32,5	1,00	1

Temperatura de uso · Use temperature
min = +5°C / max = +40°C



Sifón WHITE

Siphon à crème · Sahnebereiter
Cream whipper · Sifão creme

Ref	€	Ø (cm)	L	U.Venta
68502	40,60	9x27	0,25	1
68500	48,10	9x31	0,50	1
68501	53,60	11x36	1,00	1

Temperatura de uso · Use temperature
min = +5°C / max = +40°C



Sifón BLACK

Siphon à crème · Sahnebereiter
Cream whipper · Sifão creme

Ref	€	Ø (cm)	L	U.Venta
68604	50,70	7,8x27,3	0,50	1
68605	55,90	9,3x32,5	1,00	1

Temperatura de uso · Use temperature
min = +5°C / max = +40°C

NUNCA ponga los sifones al baño maría, puede producirse una explosión con graves consecuencias.

NE JAMAIS mettre les siphons au bain marie car une explosion pourrait avoir lieu et provoquer de graves conséquences.
NEVER put siphons in a water bath, as this may cause an explosion with serious consequences.

MANGAS REPOSTERÍA

Colección



ES

- Mangas pasteleras para decorar y personalizar tus postres preferidos.
- Mangas de alta calidad, soportan altas temperaturas, resistentes y reutilizables.
- Aptas para el lavavajillas.

FR

- Poche à douille pour décorer et personnaliser vos desserts préférés.
- Poche de grande qualité, supporte des températures élevées, résistante et réutilisable.
- Compatible avec le lave-vaisselle.

EN

- Pastry bag to decorate and customise your favourite desserts.
- Bag of high-quality withstands high temperatures and is durable and reusable.
- Dishwasher safe.



Manga repostería

Poche à décorer · Spritzbeutel
Pastry bag · Manga de pastelería

Ref	€	cm	Ø (cm)	U.Venta
A 68972	7,30	20	20x30	1
B 68973	12,40	30	25x45	1

Se adaptan a cualquier tipo de boquilla
Adapts to any kind of nozzle

Se adaptan a cualquier tipo de boquilla
No emplear con alimentos a temperaturas superiores a 60°C
Adapts to any kind of nozzle
Not for use with food at temperatures above 60°C



Manga repostería

Poche à décorer · Spritzbeutel
Pastry bag · Manga de pastelería

Ref	€	ml	h (cm)	U.Venta
68971	7,60	800	30	1



Manga repostería nylon

Poche à décorer en nylon · Nylon Spritzbeutel
Nylon pastry bag · Manga de pastelería de nylon

Ref	€	h (cm)	L	U.Venta
68930	5,10	30	0,57	6
68935	6,00	35	1,10	6
68940	6,60	40	1,45	6
68945	7,80	45	2,30	6
68950	8,60	50	2,50	6
68955	9,50	55	3,40	6
68960	10,70	60	5,50	6
68965	11,20	65	6,50	6
68970	13,50	70	7,50	6



Mangas desechables

Poche à décorer jetable · Einweg Spritzebeutel
Non-returnable pastry bags · Mangas descartables

Ref	€	Cantidad	AxB (cm)	U.Venta
68937	14,60	100	35x21	1
68939	21,00	100	40x22	1
68954	31,50	100	55x30	1
68964	36,90	100	65x32	1



BOQUILLAS

Colección

Inox
18/10
Dishwasher



ES

- Fabricadas en acero inoxidable 18/10.
- Excelente resistencia a la corrosión y a los ácidos alimentarios y sales.
- Adaptables a las mangas de repostería.
- Distintas formas para decorar postres.

FR

- Fabriquées en acier inoxydable 18/10.
- Excellente résistance à la corrosion et aux acides et sels alimentaires.
- Adaptables sur les poches à douilles de pâtisserie.
- Différentes formes pour décorer les desserts.

EN

- Made of 18/10 stainless steel.
- Excellent resistance to corrosion and to food acids and salts.
- Can be adapted to piping bags.
- Different shapes for decorating desserts.

Ø 4mm. Ø 5mm. Ø 6mm.

Ø 8mm. Ø 10mm. Ø 12mm.

Set de 6 boquillas redonda
Ensemble 6 douilles unies · Lochtüllensatz 6-tlg. rund
6 plain tube set · Conjunto de 6 boquillas redonda

Ref	€	Forma (mm)
68996	16,60	Redonda 4/5/6/8/10/12

Ø 4mm. Ø 5mm. Ø 6mm.

Ø 8mm. Ø 10mm. Ø 12mm.

Set de 6 boquillas estrella
Ensemble 6 douilles cannelées · Tüllensatz 6-tlg., Stern
6 star tube set · Conjunto de 6 boquillas estrella

Ref	€	Forma (mm)
68997	16,60	Estrella 4/5/6/8/10/12

Ø 4mm. Ø 6mm. Ø 8mm.

Ø 10mm. Ø 12mm. Ø 15mm.

Set de 6 boquillas rosa
Ensemble 6 douilles cannelées fermes · Tüllensatz
6-tlg. Stern, geschlossen
6 close star tube set · Conjunto de 6 boquillas rosa

Ref	€	Forma (mm)
68993	16,60	Rosa 4/6/8/10/12/15

Ø 6mm. Ø 8mm. 20 x 3mm.

Ø 13mm. Ø 6mm. Ø 8mm.

Set de 6 boq. variadas
Ens. 6 douilles variées · Tüllensatz 6-tlg.
6 assorted tube set · Conjunto de 6 boquillas variadas

Ref	€	Forma (mm)
68998	16,60	Rosa 6/8 Cinta 20x3 Hélice 5 Estrella 6/9/13

Ø 6mm. Ø 8mm. Ø 5mm.

Ø 6mm. Ø 5mm. Ø 12mm.

Set de 6 boquillas variadas
Ensemble 6 douilles variées · Tüllensatz 6-tlg. sortiert
6 assorted tube set · Conjunto de 6 boquillas variadas

Ref	€	Forma (mm)
68999	16,60	Rosa 6/8 Hélice 5 Estrella 6/9/13

Ø 4mm. Ø 8mm.

Set de 2 boquillas relleno
Ensemble 2 douilles petit chou · Einfülltüllensatz 2-tlg.
2 Bismark tube set · Conjunto de 2 boquillas relleno

Ref	€	Forma (mm)
68992	10,90	Relleno 4/8



Set de 6 boquillas redonda

Ensemble 6 douilles unies · Lochtüllensatz 6-tlg. rund
6 plain tube set · Conjunto de 6 boquillas redondas

Ref	€	Ø (mm)	U.Venta
68908	25,40	8	1
68910	25,40	10	1
68912	25,40	12	1
68915	25,40	15	1



Set de 6 boquillas estrella

Ensemble 6 douilles cannelées · Lochtüllensatz 6-tlg. Stern
6 star tube set · Conjunto de 6 boquillas estrella

Ref	€	Ø (mm)	U.Venta
68928	25,40	8	1
68900	25,40	10	1
68932	25,40	12	1
68934	25,40	15	1



Set de 6 boquillas rosa

Ensemble 6 douilles cannelées fermes · Tüllensatz
6-tlg. Stern, geschlossen
6 close star tube set · Conjunto de 6 boquillas rosa

Ref	€	Ø (mm)	U.Venta
68948	25,40	8	1
68980	25,40	10	1
68942	25,40	12	1
68985	25,40	15	1



Inox

Juego de boquillas decoración

Deuilles assorties décoration · Dekorations-Tüllensatz
Decorating nozzles · Jogo de boquillas decoração

Ref	€	Piezas	U.Venta
68991	16,50	26	1



	Ref	€	Ø (cm)	h (cm)	Unidades	U.Venta
A	68892	8,40	3,5	4,5	6	6
B	68893	14,50	3,0	6,2	6	1



Set 24 pcs. boquillas

24 pcs. douilles assorties · 24 tlg. Tüllensortiment
24 pcs. anozzles set · Conjunto de 24 boquillas

Ref	€	Piezas	U.Venta
68994	15,20	24	1

REPOSTERÍA

Pistolas · Botellas biberón



ES

- Ideales para salsas, cremas, aceites, aliños, vinagretas y todo tipo de condimentos líquidos.
- Dibuja, adorna y personaliza con estilo tus platos.

FR

- Idéal pour les sauces, les crèmes, les huiles, les assaisonnements, les vinaigrettes et tout type de condiments liquides.
- Il dessine, décore et personnalise les plats.

EN

- Ideal for sauces, creams, oils, dressings, vinaigrettes and all kinds of liquid condiments.
- Draw, decorate and personalize your dishes with style.



Pistola decoración repostería

Pistolet Décoration Pâtisserie · Pistole für Tüllensätze
Pastry Decoration Gun · Pistola Decoração Pastelaria

Ref	€	L	U.Venta
61407	32,60	0,25	1



Botella biberón

Bouteille biberon · Dosierflasche
Squeeze bottle · Garrafa

Ref	€	Ø (cm)	L	U.Venta
61974	4,00	7x20	0,47	6
61977	4,30	7x26	0,71	6



Botella biberón PUSH

Bouteille biberon · Dosierflasche
Squeeze bottle · Garrafa

Ref	€	Ø (cm)	L	U.Venta
61978	4,50	6x20	0,50	1
61979	4,60	7x20	0,60	1
61980	4,80	7x26	0,70	1



Biberón decoración

Biberon à décorer · Dekorierflasche
Decorating pen · Garrafa decoração

Ref	€	Ø (cm)	L	U.Venta
64457	9,50	5,5x16	0,14	1



Click here



Juego pistola repostería

Pistolet pour pâtisserie · Pistole für Tüllensätze
Cookie press cum icing set · Jogo de pistola pastelaria

Ref	€	L	U.Venta
68989	48,10	0,25	1

BAÑOS MARIA CHOCOLATE

Colección



Abertura lateral para llenar de agua (1,0 L)
Capacidad chocolate: 1,0 L
Side opening to introduce water (1,0 L)
Chocolate capacity: 1,0 L



Cazo baño maría

Casserole bain marie · Stielkasserolle für Wasserbad
Bain-marie saucepan · Caçarol para banho-maria

Ref	€	Ø (cm)	h (cm)	L	U.Venta
62600	29,90	16	10,0	1,00	1



- Cazo de doble pared para cocinar al baño maría.
- Fabricado en acero inoxidable 18/10 de máxima calidad.
- Doble pared: evita que el agua entre en contacto con el alimento.
- Abertura en el lateral para un llenado práctico y cómodo.
- Ideal para derretir chocolate, caramelo, emulsionar salsas, fundir mantequilla, etc.
- Mango de baquelita termorresistente.
- Apto para todos los fuegos (incluido la inducción).
- Fácil de usar y limpiar. Se puede lavar en lavavajillas.

- Double-walled saucepan for bain-marie cooking.
- Made of top quality 18/10 stainless steel.
- Double wall: prevents the water from coming into contact with the food.
- Convenient, easy-to-fill opening on the side.
- Ideal for melting chocolate, caramel, for blending sauces, melting butter, etc.
- Heat-resistant Bakelite handle.
- Suitable for all sources of heat, including induction.
- Easy to use and clean. Dishwasher safe.



Baño maría chocolate BLACK

Bain marie de chocolat · Bain Marie topf für Schokolade
Chocolate bain marie · Banho-maria chocolate

Ref	€	W	U.Venta
69317	41,70	50	1

- Cazo desmontable de acero inoxidable 18/10 de gran calidad
- Preparar fácilmente coberturas para sus postres.
- Permite fundir chocolate y mantenerlo caliente
- Puede añadirle especias (canela, jengibre en polvo, pimentas, vainilla) para un chocolate más intenso.

- High quality 18/10 st. steel collapsible pan
- Easily prepare toppings for your desserts.
- It allows you to melt chocolate and keep it hot
- You can add spices (cinnamon, ginger powder, peppers, vanilla) for a more intense chocolate.

Características · Characteristics:

Referencia · Reference: 69317
Tensión · Voltage: 230-240 V; 50 Hz
Potencia · Power: 50 W
Temperatura · Temperature: 40°C - 50°C
Capacidad · Capacity: 1,0 L
Dimensiones · Sizes: 29x22x12 cm
Peso · Weight: 0,875 Kg

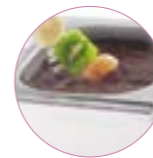

Baño maría chocolate WHITE

Bain marie de chocolat · Bain Marie topf für Schokolade
Chocolate bain marie · Banho-maria chocolate

Ref	€	W	U.Venta
69617	75,50	80	1

- Perfecta para elaborar coberturas de alta calidad y mantenerlas a la temperatura deseada durante horas.
- Ideal para la obtención de un glaseado brillante para pasteles, tartas, cake pops, muffins, etc.
- Contenedor GN1/6 (1,50L) y tapa extraíble de acero inoxidable 18/10 para garantizar una rápida y efectiva limpieza (aptos para el lavavajillas).
- Calentamiento 3D; el calor se distribuye de manera uniforme por toda la superficie del recipiente.
- Compatible con cubetas GN1/6 de Lacor.

- Perfect for making high quality toppings and keeping them at the desired temperature for hours
- Ideal for getting shiny glazing on pies, cakes, cake pops, muffins, and more
- It has a GN1/6 (1.5 L) container and removable 18/10 stainless steel lid to make cleaning fast and effective. Dishwasher safe.
- 3D Heating: Heat is distributed evenly over the entire surface of the container.
- It's compatible with GN1/6 pans from Lacor.

Características · Characteristics:

Referencia · Reference: 69617
Tensión · Voltage: 230-240 V; 50 Hz
Potencia · Power: 80 W
Temperatura · Temperature: 0°C - 50°C
Capacidad · Capacity: 1,5 L
Dimensiones · Sizes: 22,5x26x14,5 cm
Peso · Weight: 1,250 Kg

REPOSTERÍA

Utensilios

Inox
18/10
Dishwasher

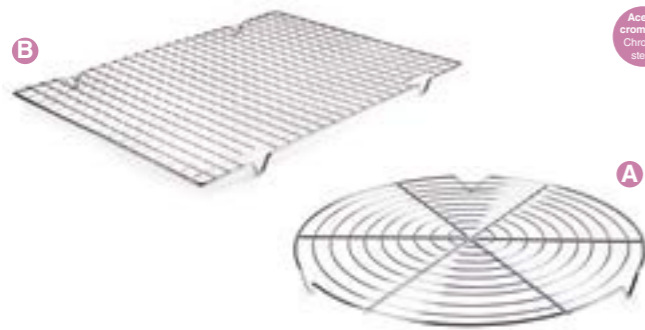

Acero cromado
Chrome steel

- Rejillas de alambre resistentes para dejar reposar los postres recién sacados del horno o cubrir de chocolate o azúcar glas.
- Fabricadas en acero cromado para una larga duración.
- Permite enfriar homogéneamente todas las partes del postre incluida la parte inferior.
- Protegen las superficies de la cocina de quemaduras.
- No se recomienda su uso en el lavavajillas.

- Grilles de refroidissement en métal pour laisser reposer les desserts fraîchement sortis du four ou les napper de chocolat ou de sucre glace.
- Fabriquée en acier chromé pour une grande durabilité.
- Permet de refroidir de façon homogène toutes les parties du dessert, y compris la partie inférieure.
- Protège les surfaces de la cuisine des brûlures.
- Lavage au lave-vaisselle déconseillé.

- Resistant wire rack for cooling freshly baked desserts or covering them in chocolate or sugar glass.
- Made of chrome steel for a long life.
- Allows all parts of the dessert to cool evenly, including the bottom.
- Protects kitchen surfaces from burns.
- Dishwasher not recommended.

Rejilla para repostería

Grille pâtisserie · Kuchengitter rund
Pastry rack · Grelha para pasteleria

Ref	€	Ø (cm)	U.Venta
66916	6,20	28	6
66926	6,30	32	6
66917	8,30	36	6
66927	8,50	43x30	6



ME
Melamine



PP
Polipropileno

Situar · Marcar · Repartir
Place · Mark · Partitioning

Porción de tarta
Slice of cake

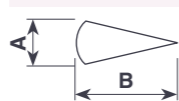

Marcador de tartas

Marqueur à gateaux · Tortenteiler
Cake marker · Marcador de bolos

Ref	€	Ø (cm)	Porciones	AxB (cm)	U.Venta
68511	8,80	27	10 / 12	8,5x13,5 / 7,5x13,5	1
68513	8,80	27	14 / 16	6x13,5 / 5,5x13,5	1

Portartas

Gueridon pâtisier · Kuchenplatte
Cake stand · Porta-tartes

Ref	€	Ø (cm)	U.Venta
67030	173,40	30	1
63586	32,50	30x9	4



Pinza repostería

Pince à gâteau · Gebäck-Tortenzange
Cake tong · Pinça pastelaria

Ref	€	L (cm)	U.Venta
62317	11,70	20	1
68008	5,90	16	6

New

Diseñada para coger galletas
Flexible
No raya
Designed to pick up biscuits
Flexible
Non-scratch

Espátula para galletas TASTY

Spatule à biscuits · Spachtel für Kekse
Biscuit spatula · Espátula para biscoitos

Ref	€	cm	L (cm)	U.Venta
68805	5,00	16,8x11	32,5	1



Inox

PA
Nylon

RACIONADORES HELADO

Colección

Inox
18/10
Dishwasher



ES

- Utensilio de repostería perfecto para formar bolas de helado sin esfuerzo.
- Mecanismo de estilo guillotina para extraer y servir fácilmente bolas de helado.
- Gran resistencia y durabilidad.
- Fácil de usar y limpiar. Apto para lavavajillas.

Fundición de inoxidable
Stainless cast iron



Racionador PROFESIONAL

Cuillère à glace professionnel · Eisportionierer, Profi
Professional ice cream scoop · Racionador profesional

Ref	€	Bolas/L	Ø (mm)	U.Venta
67038	33,50	50	39	10
67043	33,50	40	44	10
67045	34,40	36	46	10
67047	34,40	30	48	10
67049	34,40	24	50	10
67052	35,60	20	53	10
67055	35,60	16	56	10
67058	35,60	13	59	10
67062	35,60	12	63	10
67065	35,60	10	66	10
67069	35,70	8	70	10
67074	35,70	7	75	10
67084	35,70	5	85	10

FR

- Ustensile de pâtisserie parfait pour faire des boules de glace sans efforts.
- Mécanisme de style guillotine pour extraire et servir facilement les boules de glace.
- Grande résistance et durabilité.
- Facile à utiliser et à nettoyer. Apte pour le lave-vaisselle.

Fundición de inoxidable
Stainless cast iron



Racionador oval PROFESIONAL

Cuillère à glace ovale · Eisportionierer
Ice cream scoop oval · Racionador oval

Ref	€	Bolas/L	mm	U.Venta
67153	35,40	40	53x41	10
67158	35,40	30	58x48	10
67163	35,40	20	63x48	10

EN

- A perfect confectionery utensil for making balls of ice cream effortlessly.
- Guillotine style mechanism for easily scooping and serving balls of ice cream.
- Very strong and durable.
- Easy to use and clean. Dishwasher safe.



Racionador BASIC

Cuillère à glace · Eisportionierer
Ice cream scoop · Racionador de gelado

Ref	€	Bolas/L	Ø (mm)	U.Venta
67039	17,80	50	39	10
67044	17,80	40	44	10
67046	17,80	36	46	10
67048	17,80	30	48	10
67050	17,80	24	50	10
67053	18,10	20	53	10
67056	18,80	16	56	10
67059	18,80	13	59	10
67063	18,80	12	63	10
67066	19,20	10	66	10
67070	19,20	8	70	10



PA Nylon
Fibra de vidrio Fibreglass
BPA free

Racionador helado WHITE

Cuillère à glace · Eisportionierer
Ice cream scoop · Racionador de gelado

Ref	€	Bolas/L	Ø (mm)	U.Venta
67040	9,40	24	50	12

- Utensilio de repostería perfecto para formar bolas de helado sin esfuerzo.
- Diseño original, ergonómico y muy ligero.
- Fabricado en nylon y fibra de vidrio. Libre de BPA.
- Mecanismo de estilo guillotina para extraer y servir fácilmente bolas de helado.
- Cuchara de 5 cm de diámetro, 24 bolas/L de capacidad.
- Gran resistencia y durabilidad.
- Fácil de usar y limpiar. Apto para lavavajillas.

- Ustensile de pâtisserie parfait pour faire des boules de glace sans efforts.
- Conception originale, ergonomique et très légère.
- Fabriqué en nylon et fibre de verre. Sans BPA.
- Mécanisme de style guillotine pour extraire et servir facilement les boules de glace.
- Cuillère de 5 cm de diamètre, capacité de 24 boules/L.
- Grande résistance et durabilité.
- Facile à utiliser et à nettoyer. Apte pour le lave-vaisselle.

- A perfect confectionery utensil for making balls of ice cream effortlessly.
- The design is original, ergonomic and very light weight.
- Made of Nylon and fiberglass BPA free.
- Guillotine style mechanism for easily scooping and serving balls of ice cream.
- 5 cm diameter spoon, 24 balls/L capacity.
- Very strong and durable.
- Easy to use and clean. Dishwasher safe.



Racionador de helado PRO

Cuillère à glace · Eisportionierer
Ice cream scoop · Racionador de gelado

Ref	€	L (cm)	Color	U.Venta
A 67091	9,20	26,5	Azul · Blue	1
B 67092	9,20	26,5	Naranja · Orange	1
C 67093	9,20	26,5	Rojo · Red	1
D 67094	9,20	26,5	Verde · Green	1
E 67095	9,20	26,5	Transparente · Transparent	1

SAN plastic
BPA free

- Cucharas para servir helado. Fabricadas en acero inoxidable 18/10 de máxima calidad.
- Mango ergonómico en plástico SAN, diseño antideslizante.
- Disponible en diferentes colores; azul, naranja, rojo, verde y transparente.

- Cuillères pour servir la glace. Fabriquées en acier inoxydable 18/10 de grande qualité.
- Manche ergonomique en plastique SAN, conception antidérapante.
- Disponible en différentes couleurs : bleu, orange, rouge, vert et transparente.

- Spoons for serving ice cream. Made of 18/10 top quality stainless steel.
- Ergonomic SAN plastic handle, non-slip design.
- Available in different colours: Blue, orange, red, green and transparent.



AL Aluminium

Racionador helado aluminio

Cuillère à glace aluminium · Eisportionierer, Aluminium
Aluminium ice cream scoop · Racionador de gelado aluminio

Ref	€	Bolas/L	Ø (mm)	ml	L (cm)	U.Venta
67090	9,60	50	50	12	18	1



Copa baja

Coupe à glace basse · Eiskelch
Ice cream cup · Taça de gelado

Ref	€	Bolas/L	cm	U.Venta
67002	4,80	5,5	Ø9x12	12

Moldes - Aros
Moulds - Cake rings

BLACK

Colección moldes



ES

- Amplia gama de moldes de silicona para procesos de horneado y congelación.
- Antiadherentes, flexibles, duraderos, higiénicos y fáciles de limpiar.
- Soportan fuertes cambios de temperatura.
- No transmiten sabores ni olores.
- Permiten desmoldar fácil y perfectamente los alimentos.

FR

- Large gamme de moules en silicone pour enfourner et congeler.
- Antiadhésifs, flexibles, durables, hygiéniques et faciles à nettoyer.
- Supportent de fortes variations de température.
- Ne transmettent ni goûts ni odeurs.
- Permettent de démouler facilement et parfaitement les aliments.

EN

- Wide range of silicone moulds for baking and freezing processes.
- Non-stick, flexible, long-lasting, hygienic and easy to clean.
- They can withstand drastic temperature changes.
- They do not transmit flavours or odours.
- Food can be de-moulded quickly and perfectly with them.

Antiadherentes, flexibles, duraderos, higiénicos y fáciles de limpiar
Non-stick, flexible, long-lasting, hygienic and easy to clean

100%
Platinum
silicone

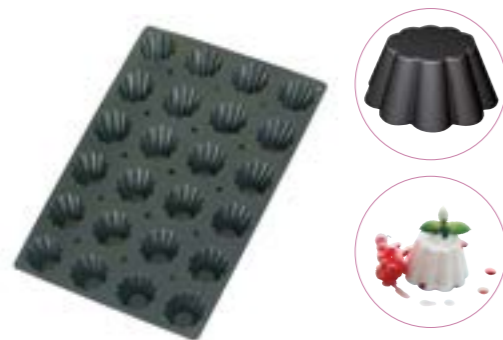

Briolette 24 cavidades

Briolette 24 cavités · Briocheform für 24 Madaleine
Briolette 24 moulds · Briolette 24 cavidades

Ref	€	Ø (mm)	h (mm)	ml
66760	100,20	79	35	84

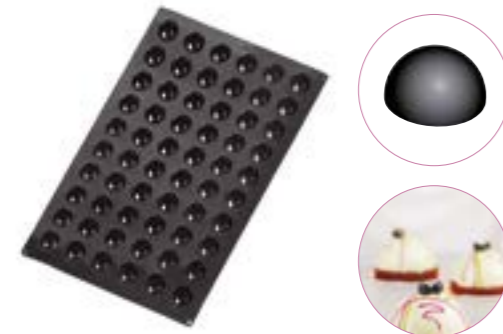

Semiesférica 60 cavidades

Hemisphere 60 cavités · Halbkugelform für 60 Madaleine
Half-spheres 60 moulds · Semi-esférica 60 cavidades

Ref	€	Ø (mm)	h (mm)	ml
66747	98,30	42	20	10



Semiesférica 28 cavidades

Hemisphere 28 cavités · Halbkugelform für 28 Madaleine
Half-spheres 28 moulds · Semi-esférica 28 cavidades

Ref	€	Ø (mm)	h (mm)	ml
66761	100,20	70	35	90

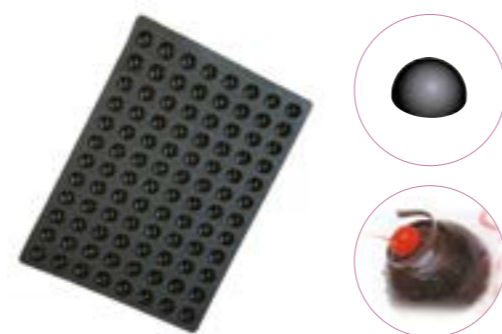

Mini semiesférica 96 cavidades

Mini Hemisphere 96 cavités · Mini Halbkugelform für 96 Madaleine
Mini Half-spheres 96 moulds · Mini semi-esférica 96 cavidades

Ref	€	Ø (mm)	h (mm)	ml
66762	100,20	35	17,5	11



Florentina 15 cavidades

Florentine 15 cavités · Florentinerform für 15 Madaleine
Florentina 15 moulds · Florentina 15 cavidades

Ref	€	Ø (mm)	h (mm)	ml
66748	98,30	100	20	100



Madalena 44 cavidades

Madeleine 44 cavités · Madeleinform für 44 Madaleine
Madeleine 44 moulds · Madalena 44 cavidades

Ref	€	mm	h (mm)	ml
66763	100,20	77x44,5	18	32



Muffin 24 cavidades

Muffin 24 cavités · Muffinform für 24 Madaleine
Muffin 24 moulds · Muffin 24 cavidades

Ref	€	Ø (mm)	h (mm)	ml
66766	100,20	69	39	122



Piramide 35 cavidades

Pyramide 35 cavités · Pyramidenform für 35 Madaleine
Pyramid 35 moulds · Pirámide 35 cavidades

Ref	€	mm	h (mm)	ml
66768	100,20	65x65	35	61



Florentina 40 cavidades

Florentine 40 cavités · Florentinerform für 40 Madaleine
Florentina 40 moulds · Florentina 40 cavidades

Ref	€	Ø (mm)	h (mm)	ml
66764	100,20	60	11	25

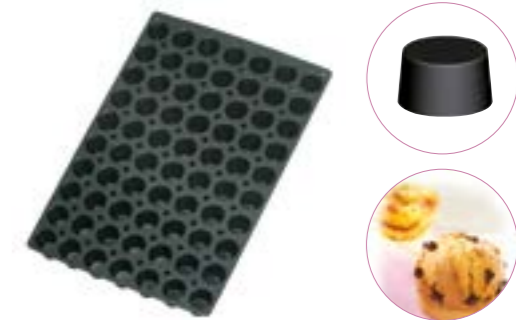

Mini muffin 70 cavidades

Mini muffin 70 cavités · Mini Muffinform klein für 70 Madaleine
Mini muffin 70 moulds · Mini muffin 70 cavidades

Ref	€	Ø (mm)	h (mm)	ml
66765	100,20	45	30	40



Tartaleta 60 cavidades

Tartalette 60 cavités · Torteileitform für 60 Madaleine
Tartlet 60 moulds · Tarte 60 cavidades

Ref	€	Ø (mm)	h (mm)	ml
66767	100,20	44	10	10



Mini cake 30 cavidades

Mini cake 30 cavités · Mini Kuchenform für 30 Madaleine
Mini cake 30 moulds · Mini cake 30 cavidades

Ref	€	mm	h (mm)	ml
66769	100,20	99x49	30	110

PASTRYFLEX

Colección moldes



ES

- Amplia gama de moldes de silicona para procesos de horneado y congelación.
- Antiadherentes, flexibles, duraderos, higiénicos y fáciles de limpiar.
- Soportan fuertes cambios de temperatura.
- No transmiten sabores ni olores.
- Permiten desmoldar fácil y perfectamente los alimentos.

FR

- Large gamme de moules en silicone pour enfourner et congeler.
- Antiadhésifs, flexibles, durables, hygiéniques et faciles à nettoyer.
- Supportent de fortes variations de température.
- Ne transmettent ni goûts ni odeurs.
- Permettent de démouler facilement et parfaitement les aliments.

EN

- Wide range of silicone moulds for baking and freezing processes.
- Non-stick, flexible, long-lasting, hygienic and easy to clean.
- They can withstand drastic temperature changes.
- They do not transmit flavours or odours.
- Food can be de-moulded quickly and perfectly with them.

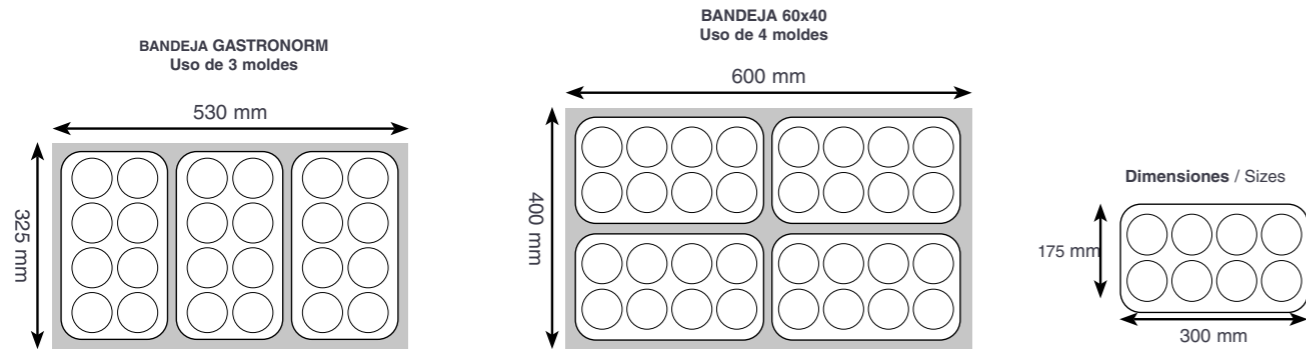

Cilindro 8 cavidades

Cylindre 8 cavités · Zylinderform für 8 Madeleine
Cylindre 8 moulds · Cilindro 8 cavidades

Ref	€	Ø (mm)	h (mm)	ml	U.Venta
66807	15,60	60	35	90	1

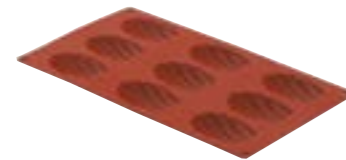

Madalena 9 cavidades

Madeleine 9 cavités · Madeleineform 9 Madeleine
Madeleine 9 moulds · Madalena 9 cavidades

Ref	€	mm	h (mm)	ml	U.Venta
66817	15,60	78x45	17	30	1



Briochette 6 cavidades

Briochette 6 cavités · Briocheform 6 Madeleine
Briochette 6 moulds · Briochette 6 cavidades

Ref	€	Ø (mm)	h (mm)	ml	U.Venta
66820	15,60	79	30	110	1



Madalena pequeña 15 cavidades

Petite madeleine 15 cavités · Madeleineform, Klein, für 15 Madeleine
Small madeleine 15 moulds · Madalena pequena 15 cavidades

Ref	€	mm	h (mm)	ml	U.Venta
66816	15,60	42x30	11,5	10	1



Briochette 6 cavidades

Briochette 6 cavités · Briocheform 6 Madeleine
Briochette 6 moulds · Briochette 6 cavidades

Ref	€	Ø (mm)	h (mm)	ml	U.Venta
66819	15,60	103	20	110	1



Semiesférica 24 cavidades

Hemispher 24 cavités · Halbkugelform 24 Madeleine
Half-spheres 24 moulds · Semi-esférica 24 cavidades

Ref	€	Ø (mm)	h (mm)	ml	U.Venta
66800	15,60	30	17	10	1



Semiesférica 15 cavidades

Hemispher 15 cavités · Halbkugelform 15 Madeleine
Half-spheres 15 moulds · Semi-esférica 15 cavidades

Ref	€	Ø (mm)	h (mm)	ml	U.Venta
66801	15,60	40	20	20	1



Pirámide 6 cavidades

Pyramide 6 cavités · Pyramideform 6 Madeleine
Pyramid 6 moulds · Pirâmide 6 cavidades

Ref	€	mm	h (mm)	ml	U.Venta
66822	15,60	71x71	41	90	1



Mini muffin 11 cavidades

Mini muffin 11 cavités · Muffinform klein für 11 Madeleine
Mini muffin 11 moulds · Mini muffin 11 cavidades

Ref	€	Ø (mm)	h (mm)	ml	U.Venta
66804	15,60	50	28	50	1

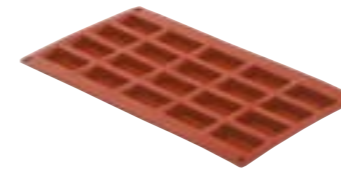

Rectángulo pequeño 20 cavidades

Petit rectangle 20 cavités · Form rechteckig für 20 Madeleine
Petit-four 20 moulds · Rectangulo pequeno 20 cavidades

Ref	€	mm	h (mm)	ml	U.Venta
66825	15,60	49x26	11	20	1



Mini savarín 18 cavidades

Mini savarin 18 cavités · Savarinform 18 Madeleine
Mini savarin 18 moulds · Mini savarin 18 cavidades

Ref	€	Ø (mm)	h (mm)	ml	U.Venta
66808	15,60	41	12	18	1



Semiesférica 6 cavidades

Hemispher 6 cavités · Halbkugelform 6 Madeleine
Half-spheres 6 moulds · Semi-esférica 6 cavidades

Ref	€	Ø (mm)	h (mm)	ml	U.Venta
66802	15,60	70	35	80	1



Muffin 6 cavidades

Muffin 6 cavités · Muffinform 6 Madeleine
Muffin 6 moulds · Muffin 6 cavidades

Ref	€	Ø (mm)	h (mm)	ml	U.Venta
66805	15,60	70	40	100	1



Corazón 8 cavidades

Coeur 8 cavités · Herzform 8 Madeleine
Heart 8 moulds · Coração 8 cavidades

Ref	€	mm	h (mm)	ml	U.Venta
66824	15,60	65x60	35	90	1



Cake 12 cavidades

Cake 12 cavités · Kuchenform 12 Madeleine
Cake 12 moulds · Cake 12 cavidades

Ref	€	mm	h (mm)	ml	U.Venta
66826	15,60	80x30	30	70	1



Molde de flan 6 cavidades

Moule à flan 6 cabités · Madeleine Backform für 6 Madeleine
Creme caramel 6 moulds · Molde de flan 6 cavidades

Ref	€	cm	h (cm)	L	U.Venta
66736	21,80	29x19	5	0,16	1



Con anilla de refuerzo
With a reinforced ring

Molde cake

Moule à cake · Kuchenform
Cake mould · Molde cake

Ref	€	cm	h (cm)	L	U.Venta
66733	21,60	24x10	6,5	1,50	1
66742	23,70	26x10	7,0	1,55	1



Con anilla de refuerzo
With a reinforced ring

Molde savarín bajo

Moule Savarin bas · Savarinform, klein
Low Savarin mould · Molde pudín baixo

Ref	€	Ø (cm)	h (mm)	L	U.Venta
66734	21,80	24	6,0	1,25	1



Con anilla de refuerzo
With a reinforced ring

Molde savarín alto

Moule Savarin haut · Savarinform, gross
High Savarin mould · Molde pudín alto

Ref	€	Ø (cm)	h (mm)	L	U.Venta
66735	23,80	22	11,0	2,20	1



Con anilla de refuerzo
With a reinforced ring

Molde redondo

Moule à manque · Tortenform
Round cake mould · Molde redondo

Ref	€	Ø (cm)	h (mm)	L	U.Venta
66737	21,20	24	4,5	1,70	1
66738	21,80	26	4,5	2,20	1



DESMONTABLES

Colección moldes



ES

- Molde 100% silicona alimentaria antiadherente a prueba de goteo.
- Base de cristal con recubrimiento antiadherente; perfecto para presentarlo en la mesa sobre la misma base.
- Se desmolda fácilmente.
- Sistema de cierre seguro antiderrame; ideal para pasteles y tartas delicadas.
- Apto para el horno.
- Fácil limpieza. Se puede lavar en el lavavajillas.

FR

- Moule 100% silicone alimentaire antiadhésif anti-gouttes.
- Base en verre avec revêtement antiadhésif ; parfaite pour présenter les mets sur la table.
- Démoulage facile.
- Système de fermeture sûr anti-coulures ; idéal pour les gâteaux et tartes délicates.
- Apte pour le four.
- Nettoyage facile. Peut se laver au lave-vaisselle.

EN

- Non-stick leak proof mould made of 100% food grade silicone.
- Cut resistant glass base coating; perfect for serving at the table on the same base.
- Easily removed from the mould.
- Secure spill-proof locking system; ideal for delicate cakes and tarts.
- Oven safe.
- Easy to clean. Dishwasher safe.

Base de cristal antiadherente
Glass base non stick



Molde desmontable

Moule demontable · Backform, zerlegbar
Dismountable mould · Molde desmontável

	Ref	€	Ø (cm)	h (cm)	L	U.Venta	
	66775	22,50	25	7,5	2,0	1	Acabado brillo · Gloss finish
A	* 66778	17,50	20	7,5	1,6	1	Acabado mate · Matt finish
B	66776	21,80	29x13	7,0	1,5	1	Acabado brillo · Gloss finish
	66777	25,40	25x25	7,5	2,5	1	Acabado brillo · Gloss finish
C	66779	21,00	18x18	7,0	2,3	1	Acabado mate · Matt finish

* Apto para la freidora de aire (69511) · Suitable for air fryer (69511)

PLATINIUM

Colección moldes

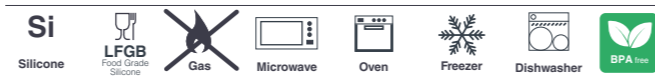

ES

- Fabricados 100% en silicona platino de máxima calidad. Libres de BPA.
- Ligeros, flexibles y antiadherentes; muy fáciles de desmoldar.
- Apilables.
- Aptos para horno, microondas y congelador.
- Se limpian muy fácil y son aptos para el lavavajillas.

FR

- Fabriqués en 100% silicone platine de la plus haute qualité. Sans BPA.
- Légers, flexible et antiadhésifs ; très faciles à démouler.
- Empilables.
- Peuvent aller au four, au micro-ondes et au congélateur.
- Facile à nettoyer et lavable au lave-vaisselle.

EN

- Made of 100% top quality platinum-cured silicone.
- Lightweight, flexible and non-stick. Very easy to de-mould.
- Stapelbar.
- Oven, microwave and freezer safe.
- It's very easy to clean and dishwasher safe.



Set de 2 moldes donuts

Ensemble de 2 moules à donuts - Set mit 2 Donut-Formen
Set of 2 doughnut moulds - Conjunto de 2 moldes para donuts

Ref	€	Ø (cm)	h (mm)	L	U.Venta
68770	16,90	7,0	2	0,07	1



Molde donuts

Moules à donuts · Donut-Formen Zweier
Doughnut moulds · Molde para donuts

Ref	€	Ø (cm)	h (mm)	L	U.Venta
68760	8,50	7,0	2	0,07	1



Molde donuts rizado

Moules à donuts frisé · Donut-Formen
Doughnut moulds curly · Molde para donuts frizado

Ref	€	Ø (cm)	h (mm)	L	U.Venta
68761	10,80	6,5	2	0,08	1



Molde muffin

Moules à muffin · Muffinform
Muffin mould · Molde muffin

Ref	€	Ø (cm)	h (mm)	L	U.Venta
68763	11,30	6,5	3	0,08	1



Molde cake

Moules à cake · Kuchenform
Cake mould · Molde cake

Ref	€	cm	h (mm)	L	U.Venta
68764	10,10	23,5x10	6	1,15	1



Molde redondo rizado

Moules à manque frisé · Tortenform
Curly round mould · Molde redondo frizado

Ref	€	Ø (cm)	h (mm)	L	U.Venta
68766	12,80	30	4,5	1,20	1



Molde savarín bajo

Moules à savarin basse · Savarinform
Low savarinmould · Molde savarin baixo

Ref	€	Ø (cm)	h (mm)	L	U.Venta
68768	16,20	25	7,0	1,50	1



Molde flan rizado

Moules à fran · Becherförmchen
Pudding mould · Molde para flan

Ref	€	Ø (cm)	h (mm)	L	U.Venta
68762	11,30	7,0	4	0,10	1



Molde redondo

Moules à manque · Tortenform
Round mould · Molde redondo

Ref	€	Ø (cm)	h (mm)	L	U.Venta
68765	13,00	28	3	1,80	1



Molde savarín

Moules à savarin · Savarinform
Savarin mould · Molde savarin

Ref	€	Ø (cm)	h (mm)	L	U.Venta
68767	19,80	22	11	2,30	1

Apto para las freidoras de aire (69509/69511)
Suitable for air fryers (69509/69511)



Molde savarín mini

Moules mini savarin · Savarinform Mini
Mini savarinmould · Molde mini savarin

Ref	€	Ø (cm)	h (mm)	L	U.Venta
68769	8,60	15	6,5	0,50	1

REPOSTERÍA

Moldes · Tapetes · Láminas



Apto para todas las freidoras de aire
Suitable for all air fryers



Set 12 moldes muffin silicona

Set 12 moules muffin en silicone · Set 12 Muffin formen, Silikon
Silicone 12 muffin moulds set · Conjunto 12 moldes muffin en silicone

Ref	€	Ø (cm)	h (cm)	U.Venta
66745	5,60	7	5	1



30 macarons -> 5cm
48 macarons -> 4cm

Flexible, antiadherente y reutilizable
Flexible, non-stick and reusable



Molde macarons doble

Moule macarons double · Doppel Macaronsform
Macarons dual mould · Molde macarons duplo

Ref	€	cm	U.Venta
66753	12,60	39x29	1

Incluye · Includes:
1.- Tablas de conversión de temperatura (°C / °F)
2.- Peso (gr / oz)
3.- Volumen ml / fl oz / pt
4.- Longitud (mm / inch)
5.- Reglas laterales (cm / inch)

Flexible, antiadherente y reutilizable
Flexible, non-stick and reusable



Tapete de silicona impreso

Tapis en silicone imprime · Bedruckte Silikonmatte
Printed silicon mat · Tapete de silicone impreso

Ref	€	cm	U.Venta
66759	28,90	60x40	1



Tapete de silicona

Tapis en silicone · Backblech-Auflage Silikon
Silicone covering · Tapete de silicone

Ref	€	cm	U.Venta
66749	20,30	30x40	1
66731	28,10	60x40	1
66732	20,80	52x32 GN 1/1	1

Apto para todas las freidoras de aire · Suitable for all air fryers

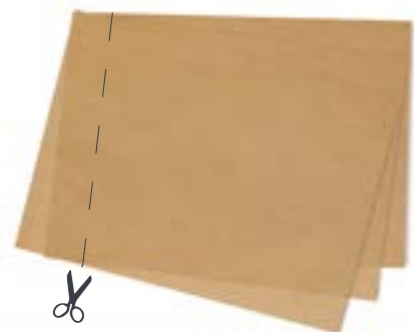

3 pcs

Fácil de cortar
Easy to cut

Láminas antiadherentes

Feuilles antiadhésif · Antihalt-Blätter
Non-stick sheets · Láminas antiaderentes

Ref	€	cm	unidades	U.Venta
66746	9,80	30x40	3	1



- Láminas de fibra de vidrio con recubrimiento antiadherente de gran calidad.
- Ideal para colocar sobre bandejas o parrillas de hornos y deshidratadores.
- Vida útil aproximadamente de 1000 horneados.
- Diseñadas para soportar temperaturas de hasta 250°C.
- Recortable para adaptar a cualquier recipiente.
- Reutilizables, para una correcta conservación se recomienda su lavado a mano.
- No aptas para el lavavajillas.

- Fibreglass sheets with non-stick coating high-quality.
- Ideal for placing on baking trays, oven racks and dehydrators.
- Can be used approximately 1,000 times.
- Designed to withstand temperatures up to 250°C.
- Can be cut to fit any container.
- Reusable; in order to keep the sheets in good condition, we recommend washing by hand.
- Non-dishwasher safe.

HORNO

Parrillas · Placas · Pinzas



Inox

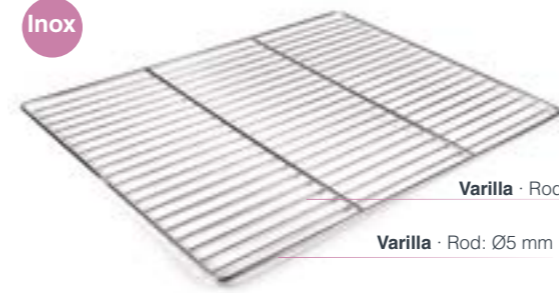

Varilla · Rod: Ø22 mm

Varilla · Rod: Ø5 mm

Parrilla

Grille · Gitter, Rost
Grate · Grelha

Ref	€	cm	h (cm)	U.Venta
68741	29,80	60x40	0,8	1

Inox

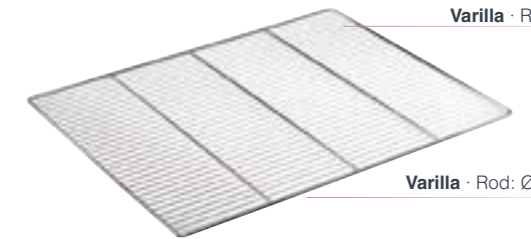

Varilla · Rod: Ø3 mm

Varilla · Rod: Ø6 mm

Parrilla

Grille · Gitter, Rost
Grate · Grelha

Ref	€	cm	Cubeta	U.Venta
66920	53,60	65X53	2/1	1
66921	20,60	53X32,5	1/1	1

AL
Aluminium



Placa horno aluminio antiadherente

Plaque à four aluminium anti-adhésif teflon · Backblech, Aluminium, Teflon
Teflon non-stick coated oven aluminium tray · Placa forno alumínio anti-aderente

Ref	€	cm	h (cm)	U.Venta
68660	37,20	60x40	1,0	1
68659	33,80	GN 1/1	1,0	1

Fe
Hierro/iron



Placa horno acero negro

Plaque à four toile noire · Backblech, Schwarzstahl
Baking sheet black steel · Placa de forno aço negro

Ref	€	cm	h (cm)	U.Venta
68640	36,60	60x40	0,8	1

Inox



Placa horno

Plaque à four · Backblech
Baking sheet · Placa de forno

Ref	€	cm	h (cm)	U.Venta
68740	44,20	60x40	0,8	1
68739	34,20	GN 1/1	0,8	1

AL
Aluminium



Placa horno

Plaque à four · Backblech
Baking sheet · Placa de forno

Ref	€	cm	h (cm)	U.Venta
68641	34,70	60x40	0,8	1
68642	28,00	GN 1/1	0,8	1



Pinza para horno y bandeja GN

Pince inox pour bac Gastronorm · Zange für GN Behälter
Tong GN tray · Pinça para forno e bandejas GN

Ref	€	L (cm)	U.Venta
A 62989	17,00	20	12
B 62998	17,00	20	12

Con silicona · With silicone



INOX 18/10

Moldes



Cadena repostería

Chaire pour pâtisserie · Kette für Konditorei
String for pastry · Corrente para pastelería

Ref	€	L (m)	U.Venta
68248	12,00	1,80	12



Molde 1/2 caña desmontable redondo

Gouttiere à bûche · Terrinen-/Kuchenform "Dachrinne",
Round cake mould · Molde 1/2 cana desmontável redondo

Ref	€	cm	h (cm)	U.Venta
68001	39,20	25x9	6,0	1
68002	49,10	50x9	6,0	1



Marco rectangular

Rectangle · Rahmen, rechteckig,
Rectangular frame · Molde rectangular

Ref	€	cm	h (cm)	U.Venta
68043	30,20	30x40	3,0	1
68048	30,40	31x48	3,0	1
68060	33,20	40x60	3,0	1
68041	30,40	30x40	5,0	1
68049	31,70	31x48	5,0	1
68061	34,40	40x60	5,0	1



Flanero

Moule à flan · Pudding-/Becherförmchen
Pudding mould · Forma flan

Ref	€	Ø (cm)	h (cm)	ml	U.Venta
60007	4,30	7	5,0	100	10
60008	5,20	8	5,3	200	10



Molde 1/2 caña desmontable triangular

Moule triangle "demie canne" · Terrinen-/Kuchenform "Dachrinne",
Three-cornered cake mould · Molde 1/2 cana desmontável triangular

Ref	€	cm	h (cm)	U.Venta
68003	38,20	25,5x9,4	9,4	1
68004	47,80	50,7x9,4	9,4	1



Bandeja

Plaque · Backblech
Baking sheet · Bandeja

Ref	€	cm	h (cm)	U.Venta
68030	39,00	30x40	1,0	1
68031	39,40	31x48	1,0	1
68040	69,60	40x60	1,0	1

ALUMINIO

Moldes



ES

- Amplia gama de moldes de aluminio con antiadherente para horno.
- Resistente a altas temperaturas, excelente conductor de calor.
- Recubrimiento antiadherente por toda la superficie de la pieza.



Set 4 flaneros

Jeu 4 Moule à flan · 4 Pudding-/Becherförmchen
4 pcs. pudding mould · Conjunto 4 formas flan

Ref	€	Ø (cm)	h (cm)	U.Venta
68808	14,40	8	5,2	6



Molde rizado

Moule à tarte fond fixe · Tortenbodenform, gewellter Rand.
Tart mould · Molde frizado

Ref	€	Ø (cm)	h (cm)	U.Venta
68723	10,90	24	3,7	6
68729	12,30	28	3,7	6
68732	13,00	32	3,7	6



Molde savarín

Moule à Savarin · Reistrand/Savarinform
Savarin mould · Molde pudim

Ref	€	Ø (cm)	h (cm)	U.Venta
68724	17,10	24x6,5	5,7	6
68862	18,50	26x6,5	6,0	6
68863	18,80	28x6,5	6,0	6

FR

- Large gamme de moules pour four en aluminium avec antiadhésif.
- Résistant à de hautes températures, excellent conducteur de chaleur.
- Revêtement antiadhésif sur toute la surface de la pièce.



Molde cake

Moule à cake · Kuchenform, konisch
Cake mould · Molde cake

Ref	€	L (cm)	h (cm)	U.Venta
68825	12,20	25	7	6
68831	14,30	30	7	6
68835	15,40	35	7	6



Molde rizado móvil

Moule à tarte fond mobile · Kuchenform, konisch
Fruit tart mould · Molde frizado-fundo móvil

Ref	€	Ø (cm)	h (cm)	U.Venta
68842	12,50	24	3	6
68882	16,50	28	3	6
68823	20,40	32	3	6



Molde pizza

Moule à pizza · Pizzablech
Pizza mould · Molde pizza

Ref	€	Ø (cm)	h (cm)	U.Venta
68824	9,90	24	1,8	6
68828	10,60	28	1,8	6
68832	13,20	32	2,0	6
68836	14,90	36	2,0	6

EN

- Wide range of non-stick aluminium moulds for the oven.
- Resistant to high temperatures, excellent heat conductor.
- The entire surface of the mould has a non-stick coating.



Molde alto

Moule à manque · Käsekuchenform
Pie mould · Molde alto

Ref	€	Ø (cm)	h (cm)	U.Venta
68822	10,20	22	4,7	6
68827	11,10	26	5,0	6
68829	12,80	30	5,0	6
68833	14,00	32	5,2	6



Molde rizado

Moule à brioche · Briocheform
Brioche mould · Molde flan frizado

Ref	€	Ø (cm)	h (cm)	U.Venta
68810	5,60	10	4,0	6
68814	7,50	14	5,5	6
68818	8,40	18	6,5	6
68821	11,40	22	10	6



Molde pizza perforado

Moule à pizza perforé · Pizzablech, gelocht
Perforated Pizza mould · Molde pizza perforado

Ref	€	Ø (cm)	h (cm)	U.Venta
67824	11,40	24	1,8	6
67828	12,10	28	1,8	6
67832	12,90	32	2,0	6
67836	13,60	36	2,0	6

DELIZE

Colección moldes



ES

- Fabricados en acero al carbono.
- Antiadherente interior y exterior de máxima calidad, ecológico y libre de PFOA.
- Diseñados para elaborar recetas con masas densas, ideal para tartas, pasteles, bizcochos, etc.
- La base desmontable y el clip lateral garantizan un mejor desmoldado y una mayor facilidad de uso.
- Resistentes a altas temperaturas.
- Fondo rugoso para una distribución uniforme y retención del calor.
- Aptos para el horno, nevera y congelador.

FR

- Fabriqués en acier carbone.
- Antiadhésif intérieur et extérieur de la plus grande qualité, écologique et sans PFOA.
- Conçus pour des recettes avec des pâtes denses, idéal pour des tartes, gâteaux, génoises, etc.
- La base démontable et la charnière latérale garantissent un meilleur démoulage et une plus grande facilité d'utilisation.
- Résistants aux hautes températures.
- Fond rugueux pour une rétenion et une distribution uniforme de la chaleur.
- Aptés pour le four, le réfrigérateur et le congélateur.

EN

- Made of carbon steel.
- Top quality non-stick inner and outer coating, environmentally friendly and PFOA-free.
- Designed for making heavy dough recipes and ideal for tarts, pies, sponge cakes, etc.
- Its spring form base and side clasp make releasing the mould quick and easy to use.
- High temperature resistant.
- Rough bottom for evenly distributing and retaining heat.
- Oven, fridge and freezer safe.

Fondo rugoso para una distribución uniforme y retención del calor
Rough bottom for evenly distributing and retaining heat



Molde desmontable

Moule démontable · Kuchenform
Dismountable mould · Molde desmontável

Ref	€	Ø (cm)	h (cm)	L	U.Venta
68676	7,70	18	6,8	1,50	1
68680	8,10	20	6,8	1,90	1
68684	9,30	24	6,8	2,80	1
68686	9,90	26	6,8	3,30	1
68688	10,90	28	6,8	3,80	1
68696	11,70	16	13	2,00	1



Molde baguette

Moule à baguette · Baguette-Form
Baguette mould · Molde para baguettes

Ref	€	cm	h (cm)	Cav.	U.Venta
68450	11,10	38x33	2,6	4	1



Molde cake

Moule à cake · Kuchenform, konisch
Cake mould · Molde cake

Ref	€	cm	h (cm)	L	U.Venta
68451	6,10	25x11,5	7,0	1,60	1
68452	7,10	31x11,5	7,0	1,90	1
68453	8,60	35,6x11,5	7,0	2,25	1



Molde alto

Moule à manque · Käsekuchenform
Pie mould · Molde alto

Ref	€	Ø (cm)	h (cm)	L	U.Venta
68455	5,90	24	4,5	1,50	1
68456	7,70	28	4,5	2,00	1

A



B



Molde rizado alto

Moule à tarte fond fixe · Tortenbodenform, gewellter Rand.
Tart mould · Molde frizado

Ref	€	Ø (cm)	h (cm)	L	U.Venta
68797	9,40	20	5,0	1,25	1
68798	10,00	24	5,0	1,90	1
68799	12,50	28	5,0	2,80	1
68787	9,80	20	5,0	-	1
68788	10,70	24	5,0	-	1
68789	12,80	28	5,0	-	1



COMPOSICIÓN:

- Bandeja: 38,2x26x1,5 cm
- Molde muffin: 33,5x20,5x3 cm (0,98 L)
- Molde cuadrado: 24x22x5,5 cm (2,01 L)
- Molde cake: 24x12x5,5 cm (0,90 L)
- Rustidera: 38,2x26x5 cm (3,40 L)



Set 5 moldes

Ensemble de 5 moules · Satz mit 5 Förmchen
Set of 5 moulds · Conjunto de 5 moldes

Ref	€	Piezas	U.Venta
68461	38,90	5	1



Molde savarín

Moule à Savarin · Reistrand/Savarinform
Savarin mould · Molde pudim

Ref	€	Ø (cm)	h (cm)	L	U.Venta
68454	10,90	26	8,6	2,15	1

A



B



Molde rizado

Moule à tarte fond fixe · Tortenbodenform, gewellter Rand.
Tart mould · Molde frizado

Ref	€	Ø (cm)	h (cm)	L	U.Venta
68790	4,40	14	2,5	0,30	1
68791	6,40	20	2,5	0,60	1
68792	8,30	24	2,8	1,00	1
68793	8,90	26	2,8	1,20	1
68794	9,40	28	3,0	1,45	1
68795	10,40	30	3,0	1,50	1
68796	11,20	32	3,0	1,70	1
68780	4,70	14	2,5	-	1
68781	6,70	20	2,5	-	1
68782	8,60	24	3,0	-	1
68783	9,30	26	3,0	-	1
68784	10,20	28	3,0	-	1
68785	10,90	30	3,0	-	1
68786	11,80	32	3,0	-	1

A



B

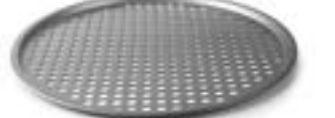

Molde pizza

Moule à pizza · Pizzablech
Pizza mould · Molde pizza

Ref	€	Ø (cm)	h (cm)	U.Venta
68472	5,30	29,5	1,5	1
68473	6,10	34,0	2,0	1
68470	6,50	33,5	1,0	1
68471	8,40	36,0	1,0	1

A



Bandeja

Plateaux · Tablett
Tray · Bandeja

Ref	€	cm	h (cm)	U.Venta
68462	12,80	34x24	2,5	1
68463	13,90	39x26,5	3,0	1
68464	16,00	44x29	3,0	1

NOIR

Moldes



ES

- Ideal para preparar todo tipo de postres, pudding, gelatinas o mousses, fríos o calientes.
- Fabricados en acero al carbono.
- Revestimiento antiadherente de gran calidad sin PFOA en el interior y el exterior.
- Distribuyen el calor de manera uniforme.
- Apto para hornos hasta 240°C.
- No se recomiendan lavarlos en el lavavajillas.

FR

- Idéal pour préparer tout type de desserts, puddings, gélatines ou mousses, froids ou chauds.
- Fabriqués en acier au carbone.
- Revêtement antiadhésif de grande qualité sans PFOA à l'intérieur et à l'extérieur.
- Distribue uniformément la chaleur.
- Compatible avec les fours jusqu'à 240°C.
- Il est déconseillé de le laver au lave-vaisselle.

EN

- Ideal for making all types of hot or cold desserts, puddings, jellies or mousses.
- Made of carbon steel.
- High quality PFOA-free non-stick coating on the inside and outside.
- Distributes heat evenly.
- Suitable for ovens up to 240°C.
- Dishwasher use is not recommended.



Molde 12 cavidades madalenas

Plaque madeleine 12 alveoles · Muffinform 12 Madeleine
12 cups madelaine pan · Molde cavidades 12 madalenas

Ref	€	cm	h (cm)	U.Venta
68000	15,30	39,8x19,5	2,0	1



Molde 12 cavidades

Plaque à biscuits 12 alveoles · Madeleine-Backform für 12 Madeleine
12 cups muffin pan · Molde 12 cavidades

Ref	€	cm	h (cm)	U.Venta
68010	18,10	35x26,5	3,0	1



Molde cake chapa antiadherente

Moule à cake tôle anti-adh. · Back/Pastetenform, Antihaf
Cake mould rolled. · Molde cake chapa aderente

Ref	€	cm	h (cm)	U.Venta
68725	8,80	25x12	8,5	6
68730	9,00	30x12	8,5	6
68735	9,90	35x12	8,5	6



Juego 4 cornetes

Ensemble de 4 moule cornet · Hornförmchen 4-tlg
4 pcs. non stick cream horn set · Jogo 4 forma de cornucópia

Ref	€	cm	U.Venta
68936	6,70	12	6



Molde desmontable redondo

Moule rond desmontable · Tortenbodenform
Dismountable round mould · M. desmontável redondo

Ref	€	Ø (cm)	h (cm)	U.Venta
68714	10,80	24	7	1
68716	11,30	26	7	1
68718	11,40	28	7	1

BOMBÓN

Moldes



ES

- Molde profesional para elaborar deliciosos y originales bombones.
- Fabricado en poliestireno de alta calidad.
- Se obtienen bombones perfectos y con un brillo único.
- Cómodo de utilizar: rellena el molde con chocolate fundido, retira el exceso de chocolate, deja reposar, vuelca el molde y da un pequeño golpe para que salgan los bombones.
- Fácil de limpiar y resistentes al uso diario.
- Superficie lisa para un mejor desplazamiento de la espátula a la hora de retirar el chocolate sobrante.

FR

- Moule professionnel pour élaborer de délicieux et originaux chocolats.
- Fabriqué en polystyrène de grande qualité.
- Permet d'obtenir des chocolats parfaits avec une brillance unique.
- Facile à utiliser : Remplir le moule de chocolat fondu, retirer l'excès de chocolat, laisser reposer, retourner le moule et tapoter légèrement pour faire sortir les chocolats.
- Facile à nettoyer et résistant à l'usage quotidien.
- Surface lisse pour un meilleur mouvement de la spatule lors du retrait du chocolat excédentaire.

EN

- Professional mould for making delicious and original chocolates.
- Made of high quality polystyrene.
- Makes perfect chocolates with a unique shine.
- Easy to use: Fill the mould with melted chocolate. Remove the excess chocolate. Let sit. Flip the mould over and tap gently to get the chocolates out.
- Easy to clean and stands up to daily use.
- Smooth finish so a spatula will slide easily over the surface when removing extra chocolate.

Dimensiones / Sizes

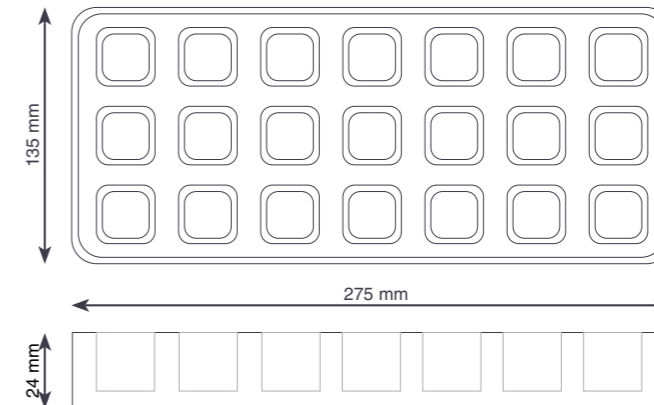

Molde bombón

Moule pour chocolats · Pralinengießform
Chocolate mould · Molde para bombons

	Ref	€	mm	h (mm)	ml	U.Venta	
A	66870	17,40	Ø28	19,0	7	1	Semiesférica · Half-sphere
B	66871	17,40	25x20	11,5	6	1	Corazón · Heart
C	66872	17,40	25,5x24,5	17,0	10	1	Lineal · Linear
D	66874	17,40	25x25	17,0	10	1	Cuadrado · Square
E	66875	17,40	32x19	12,0	7	1	Hoja · Leaf
F	66877	17,40	32x25	12,5	7	1	Ondulado · Ondulated

AROS REPOSTERÍA

Colección



ES

- Fabricados en acero inoxidable 18/10.
- Ideal para brisa, hojaldre y choux.
- Consigue bordes regulares, bien denidos y con una extracción perfecta de la base. Acabado excepcional.
- Disponible en distintas formas y tamaños.
- Aros perforados: innovadores aros de acero inoxidable microperforados. Las microperforaciones permiten la circulación de aire durante la cocción, consiguiendo una cocción más rápida y homogénea.

FR

- Fabriquée en acier inoxydable 18/10.
- Idéal pour la pâte brisée, la pâte feuilletée et la pâte à choux.
- Obtenez des bords réguliers, bien dénis, et avec une extraction parfaite de la base. Finition exceptionnelle.
- Disponible en plusieurs formes et tailles.
- Cercles perforés : cercle en acier inoxydable micro-perforé innovant. Les micro-perforations permettent la circulation d'air pendant la cuisson, obtenant ainsi une cuisson plus rapide et homogène.

EN

- Manufactured in stainless steel 18/10.
- Ideal for shortcrust, puff and choux pastry.
- Get even, well-dened edges and a perfect extraction of the base. Exceptional nish.
- Available in various different shapes and sizes.
- Perforated ring: innovative microperforated stainless steel tart ring. The microperforations enable air to circulate during cooking, ensuring faster and more even cooking.



Aro redondo

Cercle rond · Kuchen-/Ausstechformen, rund
Round cake ring · Aro redondo

Ref	€	Ø (cm)	h (cm)	U.Venta
68406	3,00	6	4	12
68407	3,10	7,5	4	12
68408	3,20	8	4	12
68410	3,30	10	4	12
68412	5,20	12	4	12
68414	4,90	14	4	6
68416	6,70	16	4	6
68418	8,00	18	4	6
68420	9,70	20	4	1
68422	9,80	22	4	1
68424	11,10	24	4	1



Aro redondo ENTREMÉT

Cercle rond · Kuchen-/Ausstechformen, rund
Round cake ring · Aro redondo

Ref	€	Ø (cm)	h (cm)	U.Venta
68308	3,10	8	3,5	12
68310	3,10	10	3,5	12



Aro redondo MOUSE

Cercle rond · Kuchen-/Ausstechformen, rund
Round cake ring · Aro redondo

Ref	€	Ø (cm)	h (cm)	U.Venta
68506	3,00	6	4,5	12
68508	3,10	8	4,5	12
68509	3,20	9	4,5	12
68510	3,30	10	4,5	12
68512	4,20	12	4,5	12
68514	4,90	14	4,5	12
68516	6,80	16	4,5	6
68518	7,90	18	4,5	6
68520	8,60	20	4,5	6
68522	10,00	22	4,5	1
68524	10,40	24	4,5	1
68526	11,50	26	4,5	1

Molde cuadrado

Carre pour patisserie · Kuchen-/Ausstech formen, vierecking
Square pastry mould · Molde cuadrado

Ref	€	cm	h (cm)	U.Venta
68460	4,70	6x6	4	12
68480	4,80	8x8	4	12
68411	4,90	10x10	4	12
68441	5,20	14x14	4	6
68240	6,60	20x20	4	6



Aro redondo VACHERIN

Cercle rond · Kuchen-/Ausstechformen, rund
Round cake ring · Aro redondo

Ref	€	Ø (cm)	h (cm)	U.Venta
68607	4,20	7	6	12
68608	4,30	8	6	12
68609	4,40	9	6	12
68610	4,60	10	6	12
68612	6,10	12	6	6
68614	7,10	14	6	6
68616	9,70	16	6	6
68618	10,90	18	6	1
68620	14,10	20	6	1
68622	15,00	22	6	1
68624	16,20	24	6	1
68626	17,30	26	6	1
68628	18,90	28	6	1



Inox 18/10

Inox 18/10



Juego aros repostería

Ensemble de cercles à pâtisserie · Ausstechformen, Set
Pastry rings set · Jogo aros de pasteleria

Ref	€	Forma	cm	h (mm)	U.Venta
68203	10,80	Redondo · Round	Ø7,7	5	1
		Redondo · Round	Ø10,7	5	
		Cuadrado · Square	8,2x8,2	5	
		Triángulo · Triangle	6x6	5	

Inox 18/10



Aro tarta borde vuelto

Cercle "goutte" · Tortenning
Tart ring · Aro torta

Ref	€	Ø (cm)	h (cm)	U.Venta
68107	3,60	8	2,2	6
68121	3,80	10	2,2	6
68120	7,60	20	2,2	1



Aro repostería extensible

Cercle extensible · Kuchenform, verstellbar
Adjustable pastry ring · Aro extensível pasteleria

Ref	€	Ø (cm)	h (cm)	U.Venta
68200	17,70	16-30	7,0	1

Inox 18/10



Aro cuadrado perforado

Cercle carre perforee · Kuchen-/Ausstechformen, vierecking, gelocht
Perforated square cake ring · Aro quadrado perforada

Ref	€	cm	h (cm)	U.Venta
68557	3,70	7x7	2,0	6
68556	6,10	16x16	2,0	6
68560	7,60	20x20	2,0	6
68567	5,00	7x7	3,5	6
68566	9,60	16x16	3,5	6
68570	11,70	20x20	3,5	6

Inox 18/10



Aro rectangular perforado

Cercle rectangulaire perforee · Kuchen-/Ausstechformen, rechteckig, gelocht
Perf. rectangular cake ring · Aro rectangular perf.

Ref	€	cm	h (cm)	U.Venta
68590	5,20	7x20	2,0	6
68598	6,40	8x28	2,0	6
68591	7,90	7x20	3,5	6
68597	10,40	8x28	3,5	6

Inox 18/10



Aro redondo perforado

Cercle rond perforee · Kuchen-/Ausstechformen, rund, gelocht
Perforated round cake ring · Aro redondo perforada

Ref	€	Ø (cm)	h (cm)	U.Venta
68537	3,10	7	2,0	6
68532	3,90	12	2,0	6
68536	5,00	16	2,0	6
68538	5,50	18	2,0	6
68540	6,30	20	2,0	6
68544	7,60	24	2,0	6
68558	8,50	28	2,0	6

Inox 18/10



Aro oval perforado

Cercle oval perforee · Kuchen-/Ausstechformen, oval, gelocht
Perforated oval cake ring · Aro oval perforada

Ref	€	cm	h (cm)	U.Venta
68580	5,00	7x20	2,0	6
68588	6,30	8x28	2,0	6
68581	7,20	7x20	3,5	6
68587	9,90	8x28	3,5	6

New



Aro corazón perforado

Cercle coeur perforee · Kuchen-/Ausstechformen, gelocht
Perforated heart ring · Aro coração perforada

Ref	€	Ø (cm)	h (cm)	U.Venta
68488	3,00	8	2,0	6
68482	4,50	12	2,0	6



Aro hoja perforado

Cercle feullere perforee · Kuchen-/Ausstechformen, gelocht
Perforated Eal ring · Aro folha perforada

Ref	€	cm	h (cm)	U.Venta
68492	3,40	12x5	2,0	6
68498	4,40	18x7,8	2,0	6



08

Eléctrico
Electric



CookingMe

Robot de cocina

· Semiprofessional use ·



ES

- Diseñado para hacerte el día a día más fácil en tu cocina.
- Realiza todas tus recetas de manera rápida y sin esfuerzo.
- Múltiples funciones: cocer, sofreír, picar, triturar, cocer al vapor, mezclar, batir, amasar, emulsionar y pesar, solo tienes que darle la orden.
- Panel de control de fácil manejo.
- Incluye accesorios para elaborar todo tipo de recetas.

FR

- Conçu pour vous faciliter la tâche dans votre cuisine quotidienne.
- Il réalise toutes les recettes de manière rapide et sans effort.
- Multiples fonctions : cuire, saisir, hacher, broyer, cuire à la vapeur, mélanger, mixer, pétrir, émulsionner et peser, vous n'avez qu'à lui donner l'ordre.
- Tableau de commande facile à manœuvrer.
- Il inclut les accessoires pour élaborer tout type de recettes.

EN

- Designed to make everyday life easier in your kitchen.
- Makes all your recipes quickly and effortlessly.
- Multiple functions: cook, sauté, chop, shred, steam, mix, beat, knead, emulsify and weigh, you just have to give the order.
- Easy-to-use control panel.
- Includes accessories to make all kinds of recipes.

TODO EN UNO · ALL-IN-ONE



CookingMe

Ref	€	U.Venta	
69561E	849,00	1	CookingMe + Recetario en ESPAÑOL · Recipe book in SPANISH
69561F	849,00	1	CookingMe + Recetario en FRANCÉS · Recipe book in FRENCH
69561I	849,00	1	CookingMe + Recetario en INGLÉS · Recipe book in ENGLISH

Ref	Tensión/ Voltage	Potencia/Power	Velocidad Speed	Temp./Temp.	Capacidad capacity	Funciones/Memorias Functions/Memories	Báscula Scale	Dimensiones Sizes	Peso/Weight
69561E	220-240 V; 50/60 Hz	Motor:1000 W Calent./Heating:1000 W	60 - 10.000 r.p.m	37°C - 120°C	2,0 L	15 / 3	5 Kg (div.: 1 g)	39x30x33 cm	7,80 Kg

Accesorios · Accessoires · Accessories



Recetario

Cookbook · Kochbuch
Cookbook · Livro de receitas

Ref	€	U.Venta	
R69561N	31,00	1	Español · Spanish
R69561P	31,00	1	Francés · French
R69561Q	31,00	1	Inglés · English



Jarra

Pitcher · Kanne
Picher · Jarra

Ref	€	L	U.Venta
R69561A	180,40	2,0	1



Tapa para jarra

Couvercle pour picher · Deckel für Kanne
Lid for picher · Tampa para jarra

Ref	€	U.Venta
R69561E	14,60	1



Vaso dosificador

Verre doseur · Dosierbecher
Measuring glass · Copo dosificador

Ref	€	ml	U.Venta
R69561W	2,50	100	1



Cestillo colador

Panier passoire vapeur · Dampfsieb
Steam strainer basket · Cesto coador

Ref	€	U.Venta
R69561C	17,60	1



Anilla fijación/bloqueo

Anneau de fixation/verrouillage · Dichtungsring/Arretierung
Fixing ring · Anilla de fixação/bloqueio

Ref	€	U.Venta
R69561Z	2,50	1



Cuchillas

Couteaux · Klinge
Blades · Lâminas

Ref	€	U.Venta
R69561B	35,10	1



Amasador

Accessoire à pétrir · Kneteinsatz
Kneader · Acessório para amassar

Ref	€	U.Venta
R69561V	29,00	1



Emulsionador

Fouet · Rührraufsatz (Schmetterlig)
Emulsifier · Batedor de borboleta

Ref	€	U.Venta
R69561T	4,80	1

No incluida / Not included



Vaporera

Ensemble vapeur · Dampfeinsatz
Steam · Conjunto de vapor

Ref	€	U.Venta
R69561D	84,30	1

Accesorios aptos para la limpieza en el lavavajillas · Accessoires adaptés au nettoyage au lave-vaisselle · Accessories suitable for cleaning in the dishwasher



Pan y masas
Bread and pasta



Salsas
Sauces



Sopas
Soups



Verduras
Vegetables



Pescados
Fish



Carnes
Meats



Bebidas
Drinks



Postres
Desserts

WHITE Arrocera

· Household use ·



Marcaje interior en la cubeta
Marking inside the cuvette

ES

- Cubeta interna extraíble con recubrimiento antiadherente 100% ECO y libre de PFOA.
- Cestillo de vapor removible para cocer verduras, patatas, pescado, etc.
- Incluye cuchara y vaso medidor.
- Tapa fabricada en vidrio con salida de vapor para evitar la cocción excesiva de los alimentos.
- Función de conservación del calor y protección contra la ebullición en seco.
- Luces indicadoras para cocinar y mantener caliente.
- 100% estable gracias a sus pies antideslizantes.
- Muy fácil de limpiar.

FR

- Cuve interne extractible avec revêtement antiadhésif 100% ECO et sans PFOA.
- Panier de vapeur amovible pour cuire des légumes, des pommes de terre, du poisson, etc.
- Inclut une cuillère et un verre doseur.
- Couvercle fabriqué en verre avec sortie de vapeur pour éviter la cuisson excessive des aliments.
- Fonction de conservation de la chaleur et protection contre l'ébullition à sec.
- Témoins lumineux pour cuire et maintenir au chaud.
- 100% stable grâce à ses pieds antidérapants.
- Très facile à nettoyer.

EN

- Removable inner pot with 100% ECO PFOA free non-stick coating.
- Removable steam basket to cook vegetables, potatoes, fish, etc.
- Includes spoon and measuring cup.
- Lid made of glass with steam outlet to prevent overcooking.
- Warm function and boil-dry protection.
- Cook and Warm indicator lights.
- 100% stability thanks to its non-slip feet.
- Very easy to clean.



Arrocera

Cuiseur à riz · Reiskocher
Rice cooker · Arrozeira/vaporeira



· Professional use ·

No incluye vaporera
Steam not included

Ref	€	W	L	U.Venta
69441	45,80	400	1,00	1
A 69233	52,50	700	1,80	1
B 69346	187,10	1300	3,6	1
R69346F	14,90	-	-	1

New

Vaporera · Steam

Ref	Tensión/Voltage	Potencia/Power	Capacidad/Capac.	Raciones/Servings	Medidor/Glass	Dimensiones Sizes	D. con vaporera Sizes with steam	Peso Weight
69441	220-240 V; 50/60 Hz	400 W	1,00 L	5	150 g arroz (rice) 160 ml agua (water)	27,5x23,5x28,5 cm	27,5x23,5x22 cm	1,80 Kg
69233	220-240 V; 50/60 Hz	700 W	1,80 L	10	150 g arroz (rice) 160 ml agua (water)	32x28,5x30,5 cm	32x28,5x30,5 cm	2,30 Kg
69346	220-240 V; 50/60 Hz	1300 W	3,60 L	20	150 g arroz (rice) 160 ml agua (water)	41,5x35x30 cm	-	3,75 Kg

TRI & SIX OVUM Cocedor de huevos

· Household use ·



ES

- Fabricados con base de acero inoxidable 18/10 y tapa transparente libre de BPA.
- Diseñados para cocinar huevos de diferentes tamaños y en 3 formas diferentes: huevo duro, huevo mollet o huevo pasado por agua.
- Capacidad para cocer hasta 3 huevos a la vez (69343-Tri Ovum).
- Capacidad para cocer hasta 6 huevos a la vez (69344-Six Ovum).
- Apagado automático y señal acústica automática al terminar el proceso de cocción.
- Incluyen un vaso medidor (70 ml) con perforador que indica la cantidad de agua que hay que introducir.
- Totalmente desmontables y muy fácil de limpiar.

FR

- Fabriqués avec une base en acier inoxydable 18/10 et un couvercle transparent sans BPA.
- Conçus pour cuire des oeufs de différentes tailles et de 3 façons différentes : oeuf dur, oeuf mollet ou oeuf à la coque.
- Capacité pour cuire jusqu'à 3 oeufs à la fois (69343-Tri Ovum).
- Capacité pour cuire jusqu'à 6 oeufs à la fois (69344-Six Ovum).
- Arrêt automatique et signal sonore automatique à la fin du processus de cuisson.
- Inclut un verre doseur (70 ml) avec perforateur qui indique la quantité d'eau à mettre selon le type d'oeuf à faire cuire.
- Entièrement démontable et très facile à nettoyer.

EN

- Made with 18/10 stainless steel and a BPA free transparent lid.
- Designed for cooking different size eggs in three different ways, hard boiled, mollet eggs or soft boiled eggs.
- Capacity for making up to 3 (69343) / 6 (69344) eggs at once.
- Automatic shut-off and beeps when the boiling process is done.
- Includes a measuring cup (70ml) with a perforator that shows the amount of water to use depending on the kind of eggs you want to make.
- Can be completely disassembled and it's very easy to clean.



Cocedor de huevos TRI OVUM

Cuiseur à oeufs · Eierkocher
Egg cooker · Máquina de cozer ovos

Ref	€	W	Capac.	U.Venta
69343	23,90	210	3 huevos	1

Ref	Tensión/Voltage	Potencia/Power	Capacidad/Capacity	Cap. vaso/Glass cap.	Dimensiones/Sizes	Peso/Weight
69343	220-240 V; 50/60 Hz	210 W	3 huevos · eggs	70 ml	20,2x8,6x13,5 cm	0,60 Kg
69344	220-240 V; 50/60 Hz	210 W	6 huevos · eggs	70 ml	23,5x13x14 cm	1,12 Kg



Cocedor de huevos SIX OVUM

Cuiseur à oeufs · Eierkocher
Egg cooker · Máquina de cozer ovos

Ref	€	W	Capac.	U.Venta
69344	34,40	210	6 huevos	1



SALCHICHAS

Cocedor · Asador

Professional use



Cocedor de salchichas

Machine à hot-dogs · Hot dog Wärmer
Sausage cooker · Máquina de cozer salsichas

Ref	€	W	L	U.Venta
69543	464,00	540	1,0	1

- Fabricada en acero inoxidable de alta calidad.
- Ideal para cocinar al vapor salchichas, mazorcas de maíz, etc.
- Amplia cubeta de cristal y 3 pinchos para calentar los panecillos o bollos.
- Termostato regulable. Calentamiento rápido y efectivo.
- Dos interruptores independientes para cocinar simultáneamente o por separado las salchichas y los panes.
- NO necesita aceite ni grasa.
- Pies de goma antideslizantes para una mayor estabilidad.

- Fabriquée en acier inoxydable de grande qualité.
- Idéale pour cuire à la vapeur des saucisses, des épis de maïs, etc.
- Grand cylindre en verre et 3 plots pour faire chauffer les petits pains.
- Thermostat réglable. Chauffe rapide et efficace.
- Deux interrupteurs indépendants pour faire cuire simultanément ou séparément les saucisses et les pains.
- Ne nécessite ni huile ni graisse.
- Pieds en caoutchouc antidérapant pour une meilleure stabilité.

- Made of high quality stainless steel.
- Perfect for steaming sausages, corn on the cob, etc.
- The large glass pan and three sticks for heating buns.
- Adjustable thermostat, fast and effective heating.
- Two independent switches for cooking sausages and buns simultaneously or separately.
- Does not need oil or grease.
- Rubber non-slip feet for greater stability.

Ref	Tensión/Voltage	Potencia/Power	Temperatura/Temperature	Capacidad/Capacity	Altura tubos pan/Bread tube height	Contenedor/Container	Cestillo/Basket	Dimensiones/Sizes	Peso/Weight
69543	220-240 V; 50/60 Hz	540 W	35°C - 100°C	1,0 L	18 cm	Ø20x24 cm	Ø17x21 cm	24x50x38,5 cm	10 Kg



Asador de salchichas

Grill à hot-dogs · Würstchengrill
Sausage roaster · Assador de salsichas

Ref	€	W	U.Venta
69547	520,80	590	1

- Fabricado en acero inoxidable de alta calidad
- Posibilidad de asar y calentar simultáneamente cualquier tipo de salchicha.
- Ideal para cualquier restaurante, bar, food truck, etc.
- Parrilla con 7 rodillos con rotación de 360° para asegurar una cocción uniforme de los alimentos.
- 2 zonas de cocción con reguladores de temperatura independientes.
- Fácil limpieza. Bandeja de goteo extraíble.
- Pies de goma antideslizantes para una mayor estabilidad.

- Fabriqué en acier inoxydable de grande qualité.
- Possibilité de cuire et faire chauffer simultanément tout type de saucisse.
- Idéal pour les restaurants, bars, food trucks, etc.
- Grill avec 7 rouleaux rotatifs à 360° pour garantir une cuisson uniforme des aliments.
- 2 espaces de cuisson avec thermostats indépendants.
- Nettoyage facile. Plateau recueil-gouttes extractible.
- Pieds en caoutchouc antidérapant pour une meilleure stabilité.

- Made of high quality stainless steel
- Any kind of sausage can be grilled or heated simultaneously
- Perfect for any restaurant, bar, food truck, etc.
- Grill with 7 rollers with 360° rotation to ensure food is cooked uniformly
- Two cooking areas with independent temperature regulators
- Easy to clean Removable drip tray
- Rubber non-slip feet for greater stability

Ref	Tensión/Voltage	Potencia/Power	Temperatura/Temp.	Tubos/Tubes	Distancia entre tubos		Dimensiones/Sizes	Peso/Weight
					Dist. between tubes			
69547	220-240 V / 50 Hz	590 W	30°C - 170°C	50 cm	1 cm		65x35,5x28 cm	10.5 Kg

WHITE

Panificadora

Household use



Click here



ES

- Amasa, fermenta y hornea todo tipo de panes gracias a sus 12 programas.
- Incluye programas especiales para preparar pan sin gluten, pan de trigo o masa para pizza.
- Producto versátil; permite escoger entre panes de 700g o 1000 g y seleccionar 3 niveles de tostado.
- Fácil de usar; dispone de un selector de programas y un selector de tiempo.
- Panel de control intuitivo con todos los parámetros indicados en una pantalla LCD.
- Cubeta antiadherente extraíble, no apta para el lavavajillas.
- Exterior resistente al calor y con protección contra el sobrecalentamiento.

FR

- Pétrit, fermente et cuisine tout type de pains grâce à ses 12 programmes.
- Inclut des programmes spéciaux pour préparer du pain sans gluten, du pain au blé ou de la pâte à pizza.
- Produit polyvalent : permet de choisir entre des pains de 700 g ou de 1000 g et de sélectionner 3 niveaux de brunissage.
- Facile à utiliser : dispose d'un sélecteur de programmes et d'un sélecteur de temps.
- Écran de contrôle intuitif avec tous les paramètres indiqués sur un écran LCD.
- Cuve antiadhésive extractible, non apte pour le lave-vaisselle.
- Extérieur résistant à la chaleur et disposant d'une protection contre la surchauffe.

EN

- Knead, ferment and bake all kinds of bread thanks to its 12 programmes.
- It includes special programmes for creating gluten-free or wholemeal bread, or even pizza dough.
- Versatile: it allows you to choose between 700 g and 1000 g bread and 3 different crust colours.
- Easy to use: it has a programme selector and a time selector.
- Intuitive control panel with an LCD screen that displays all of the settings.
- Non-stick baking pan that can be removed, but is not suitable for dishwashers.
- Heat-resistant exterior that is protected against overheating.



Panificadora automática

Machine à pain · Brotbackmaschine
Bread-making machine · Máquina de fazer pão

Ref	€	W	L	U.Venta
69334	142,70	550	1,0	1



Ref	Tensión/Voltage	Potencia/Power	Capacidad/Capacity	Funciones/Functions	Temporizador/Timer	Dimensiones/Sizes	Peso/Weight
69334	220-240 V; 50/60 Hz	550 W	1,0 L	12	13 horas · hours	36x24,5x28 cm	4,50 Kg

YOGURTERAS

Colección

Household use



New



Yogurtera de vasos DEVA

Yaourtière à pots · Joghurt-Maker mit Glasbehältern
Yoghurt maker with jars · logurteira de frascos

Ref	€	W	U.Venta
69439	60,20	40	1
A 69438	15,40	-	9

- Ideal para preparar deliciosos yogures caseros naturales y saludables.
- Incluye 9 tarros de vidrio extraíbles con capacidad de 170 ml y tapa hermética.
- Temperatura ajustable entre 25°C - 65°C y temporizador hasta 99 horas.
- Carcasa rectangular de acero inoxidable y tapa transparente para controlar el proceso de elaboración.
- Apagado automático y señal acústica al final de la preparación.
- Pantalla digital con retroiluminación.
- Pies de goma antideslizantes.
- 100% libre de BPA.
- Fácil limpieza. Tarros y tapas aptos para el lavavajillas.

- Idéale pour préparer de délicieux yaourts faits maison, naturels et sains. Inclut 9 pots en verre extractibles d'une capacité de 170 ml et couvercle hermétique.
- Température réglable de 25°C à 65°C et minuteur jusqu'à 99 heures.
- Structure rectangulaire en acier inoxydable et couvercle transparent pour surveiller le processus d'élaboration.
- Arrêt automatique et signal sonore à la fin de la préparation.
- Écran digital rétroéclairé.
- Pieds en caoutchouc antidérapant.
- 100% sans BPA.
- Nettoyage facile. Pots et couvercles aptes pour le lave-vaisselle.

- Ideal for making delicious, natural and healthy homemade yoghurts.
- Includes 9 separate 170 ml capacity jars with airtight lids.
- Programmable 25°C - 65°C temperature settings and 99-hour timer.
- Rectangular stainless steel casing and transparent lid to control the process.
- Automatic switch-off and audible beep at the end of the process.
- Digital display with backlight.
- Non-slip rubber feet.
- 100% BPA free.
- Easy to clean. Dishwasher safe jars and lids.

Ref	Tensión/Voltage	Potencia/Power	Temperatura/Temp.	Capacidad/Capacity	Vasos/Jars	Dimensiones/Sizes	Peso/Weight
69439	220-240 V; 50-60 Hz	40 W	25°C - 65°C	170 ml (9)	9	26x24,6x13,5 cm	10,30 Kg

ES

- Diseñadas para elaborar yogur, kéfir, yogur griego y queso fresco casero de la textura y sabor que desees. Más sanos y naturales.
- Prácticas y muy fáciles de usar. Supersilenciosas.
- Tiempo de preparación de 8-14 h.
- Apagado automático con señal acústica al finalizar el proceso.
- Incluyen un práctico recetario para elaborar todo tipo de yogures, queso fresco y kéfir.

FR

- Conçue pour préparer du yaourt, Kéfir, yaourt grec et fromage blanc fait maison avec la texture et le goût. Plus sain et plus naturel.
- Pratiques et très faciles à utiliser. Très silencieuses.
- Durée de préparation : 8-14 h.
- Arrêt automatique avec signal sonore à la fin de la préparation.
- Inclut un livre de recettes pour préparer tous types de yaourts, fromages blancs et kéfirs.

EN

- Designed to make yoghurt or homemade kefir with the texture and flavour of your choice. Healthier and more natural.
- Practical and very easy to use. Super silent.
- Preparation time 8-14 h.
- Switches off automatically with an audible beep at the end of the process.
- Includes a practical recipe booklet for making all kinds of yoghurt, fresh cheese and kefir.



7 tarros de cristal
7 glass jars

Yogurtera de vasos MULTI

Yaourtière à pots · Joghurt-Maker mit Glasbehältern
Yoghurt maker with jars · logurteira de frascos

Ref	€	W	U.Venta
69245	45,40	20	1



Set 7 tarros

Set 7 bocaux · 7-Tlg. Gläser ein
Set 7 jars · Conjunto de 7 potes

Ref	€	U.Venta
69244	10,90	7
R69245B	1,50	7

Set 7 tarros cristal · Set 7 glass jar

Tarro de cristal · Glass jar

Ref	Tensión/Voltage	Potencia/Power	Temporizador/Timer	Capacidad/Capacity	Dimensiones/Sizes	Peso/Weight
69245	220-240 V; 50/60 Hz	20 W	1 -14 h	190 ml	Ø25x12 cm	1,80 Kg



Yogurtera WHITE

Yaourtière · Joghurt-Maker
Yoghurt maker · logurteira

Ref	€	W	U.Venta
69246	39,60	20	1

Yogurtera MAXI

Yaourtière · Joghurt-Maker
Yoghurt maker · logurteira

Ref	€	W	L	U.Venta
69243	40,50	20	2,0	1

Yogurtera HERA

Yaourtière · Joghurt-Maker
Yoghurt maker · logurteira

Ref	€	W	L	U.Venta
69345	38,80	20	1,0	1

Ref	Tensión/Voltage	Potencia/Power	Capacidad/Capacity	Dimensiones/Sizes	Peso/Weight
69246	220-240 V; 50/60 Hz	20 W	1,0 L (Filtro · Filter) 1,6 L (Pequeño · Small) 1,8 L (Grande · Big)	18x16x24 cm	0,85 Kg
69243	220-240 V; 50/60 Hz	20 W	2,0 L	Ø20x23 cm	1,17 Kg
69345	220-240 V; 50/60 Hz	20 W	1,0 L	Ø16,8x18,8 cm	0,70 Kg

MÁQUINAS HELADO

Colección

· Household use ·



Máquina de helado MyCream
Machine de crème glacée - Eis Maschine
Ice cream machine - Máquina de gelado

Ref	€	W	L	U.Venta
69315	468,30	150	1,40	1



- Una nueva forma de hacer helado cremoso y saludable.
 - Puedes realizar infinidad de helados de; fresa, plátano, kiwi, mango, piña, melón, etc.
 - Ideal para dietas especiales: sin leche, sin azúcar, sin gluten.
- Une nouvelle façon de faire des glaces crémeuses et saines.
 - Vous pouvez réaliser une infinité de glaces : à la fraise, à la banane, au kiwi, à la mangue, à l'ananas, à l'orange, au melon, etc.
 - Idéale pour les régimes alimentaires spéciaux : sans lait, sans sucre, sans gluten.
- A new way to make creamy and healthy ice cream.
 - You can make a wide variety of ice creams; strawberry, banana, kiwi, mango, pineapple, orange, melon, etc.
 - Ideal for special diets: milk-free, sugar-free, gluten-free.

Ref	Tensión/Voltage	Potencia/Power	Temperatura/Temp.	Capacidad/Capacity	Tiempo/Timer	Dimensiones/Sizes	Peso/Weight
69315	220-240 V / 50 Hz	150 W	-18°C / -35°C	1,40 L	60 min.	38x29x31 cm	10,30 Kg



Accesorio para helado de frutas
Fruit ice cream accessory

2 en 1

5 cuchillas de colores
5 colored blades



Corta vegetales + máquina de helado COSMO

Hachoir légumes + machine à fruitcreme glacée - Gemüseschneider + Obst-Eis machine
Vegetables cutter + ice fruit machine - Corta vegetales + máq. de gelado de fruta

Ref	€	W	U.Venta
69115	80,30	150	1

Ref	Tensión/Voltage	Potencia/Power	Cuchillas/Blades	Dimensiones/Sizes	Peso/Weight
69115	220-240 V; 50/60 Hz	150 W	6	24,5x22,5x19,5 cm	1,89 Kg



- Versátil: Procesador eléctrico de verduras con accesorio para hacer helado.
 - Incluye 6 cuchillas de corte (en formato cono) de acero inoxidable de máxima calidad para todo tipo de cortes; verdura, fruta, queso, frutos secos, chocolate, etc.
 - Incluye un accesorio diseñado para hacer helados y sorbetes con fruta congelada.
 - Rápido, intuitivo y muy fácil de usar.
 - Compacto: Práctico para usar y guardar; las cuchillas se almacenan en el interior.
 - 100% seguro: no hay contacto directo con las manos.
 - Funcionamiento silencioso.
 - Fácil de limpiar: accesorios aptos para el lavavajillas.
 - 100% Libre de BPA.
- Fully versatile: electric vegetable cutter with an ice cream attachment.
 - Includes 6 top quality stainless steel, cone-type cutting blades for all kinds of cuts; suitable for vegetables, fruit, cheese, nuts, chocolate, etc.
 - Comes with an attachment to make ice cream and sorbets from frozen fruit.
 - Very practical, quick and easy to use.
 - Compact: convenient to use and store; blades neatly stored inside.
 - 100% safe: no direct contact with hands.
 - Silent operation.
 - Easy to clean: dishwasher safe accessories.
 - 100% BPA free

Click here



CORN

Palomitera

· Household use ·



ES

- Prepara palomitas saludables sin necesidad de utilizar aceite, gracias a su sistema de cocción por aire caliente.
- Palomitas recién hechas en tan solo 3 minutos.
- Capaz de cocinar hasta 80 g de maíz por cada ciclo de trabajo.
- Incluye cuchara medidora para el maíz que te ayudará a calcular las raciones.
- Interruptor de encendido / apagado.
- Pies antideslizantes.

FR

- Préparer du pop-corn sain sans utiliser d'huile grâce au système de chauffe avec de l'air chaud.
- Pop-corn frais en seulement 3 minutes.
- Capable de transformer jusqu'à 80 g de maïs par cycle de travail.
- Inclut une cuillère-mesure pour le maïs qui aidera à calculer les portions.
- Interruption de marche / arrêt.
- Pieds antidérapants.

EN

- Prepare healthy popcorn without using oil thanks of its hot air cooking system.
- Fresh popcorn in just 3 minutes.
- It can pop up to 80g of corn in every cycle.
- A measuring spoon for corn is included to help you calculate servings.
- On/off switch.
- Non-slip feet.



Palomitera

Machine à pop-corn - Popcorn-Maschine
Popcorn maker - Máquina de fazer pipocas

Ref	€	W	g	U.Venta
69299	38,50	1000	80	1

Ref	Tensión/Voltage	Potencia/Power	Capacidad/Capacity	Dimensiones/Sizes	Peso/Weight
69299	220-240 V ; 50/60 Hz	1000 W	80 g	14,5x21,5x30 cm	0,870 Kg

BATIDORAS AMASADORAS

Colección



Batidora amasadora PROFESIONAL

Batteur pétrisseur · Mix- und Knetmaschine
Mixer-kneader · Batedeira amassadora

Ref	€	W	L	U.Venta
69084	864,50	300	5,0	1



· Professional use ·

- Batir, mezclar y amasar productos para la preparación de alimentos.
- Velocidad regulable, doble movimiento de giro, rotativo y orbital.
- Brazo basculante para acoplar los distintos accesorios.

- Batre, mélanger et pétrir des produits pour la préparation d'aliments.
- Vitesse réglable, double mouvement de rotation, rotatif et orbital.
- Bras pivotant pour fixer aisément les différents accessoires.

- Beat, mix and knead products to food preparation.
- Adjustable speed, double twisting, rotating and orbital motion.
- Swing arm for connection of different accessories.

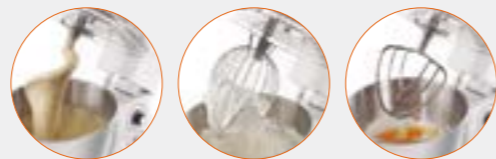

Ref	Tensión/Voltage	Potencia/Power	Velocidad/Speed	Velocidad/Speed	Capacidad/Cap.	Dimensiones/Sizes	Peso/Weight
69084	220-240 V; 50/60 Hz	300 W	3	130 - 850 r.p.m.	5,0 L	37 x 23,5 x 43 cm	19 Kg



Velocidades
6+PULSE
Speeds

1,2 Kg de cap. para el amasado
1,2 kg mixer capacity

Batidora amasadora GOURMET

Batteur pétrisseur · Mix- und Knetmaschine
Mixer-kneader · Batedeira amassadora

Ref	€	W	L	U.Venta
69388	211,50	600	4,0	1



· Household use ·

- Regulador de velocidad para 6 velocidades y función PULSE (Turbo).
- Amasado con movimientos planetarios. Doble movimiento de giro, rotatorio y orbital.
- Brazo basculante de 35° para acoplar los distintos accesorios.
- Tapa transparente anti-salpicaduras con ventana para añadir ingredientes durante el uso.

- Régulateur de vitesse pour 6 vitesses et fonction PULSE (Turbo).
- Pétrissage avec des mouvements planétaires. Double mouvement de rotation, rotatoire et orbital.
- Bras pivotant de 35° pour fixer aisément les différents accessoires.
- Couvercle transparent anti-éclaboussures avec fenêtre pour ajouter les ingrédients pendant l'utilisation.

- Speed regulator with 6 speeds and a PULSE (Turbo) function.
- Mixer with planetary motion. Twin twisting, rotational and orbital movement.
- 35° swing arm for connection of different accessories.
- Transparent anti-splatter lid with opening for adding ingredients during use.

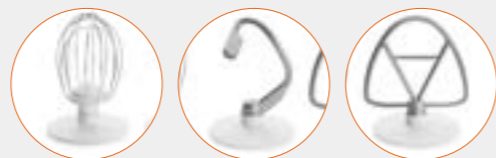

Ref	Tensión/Voltage	Potencia/Power	Velocidad/Speed	Velocidad/Speed	Capacidad/Cap.	Dimensiones/Sizes	Peso/Weight
69388	220-240 V; 50/60 Hz	600 W	6	60 - 180 r.p.m.	4,0 L	35x22x30 cm	4,40 Kg



Accesorio jarra

Accessoire cruche · Krugzubehör
Jug accessory · Acessório de jarro

Ref	€	L	U.Venta	
A 69584	27,20	1,5	1	Batidora amasadora DELICY
B 69684	27,20	1,5	1	Batidora amasadora COMPLET



Accesorio picadora/embutidora/kibbe

Accessoire hachoir/stuffer/kibbe · Fleischwolf/Wurstfüller/Kibbe Zubehör
Chopper/stuffer/kibbe accessory · Acessório picador/stuffer /kibbe

Ref	€	L	U.Venta
69685	57,60	1,5	1



Velocidades
5+PULSE
Speeds

Batidora amasadora DELICY

Batteur pétrisseur · Mix- und Knetmaschine
Mixer-kneader · Batedeira amassadora

Ref	€	W	L	U.Venta
69583	354,80	1000	5,0	1



Velocidades
6+PULSE
Speeds

Batidora amasadora COMPLET

Batteur pétrisseur · Mix- und Knetmaschine
Mixer-kneader · Batedeira amassadora

Ref	€	W	L	U.Venta
69683	382,10	1500	6,0	1

Ref	Tensión/Voltage	Potencia/Power	Velocidades/Speeds	Veloc. Amasadora/Kneading speed	Velocidad jarra/Jug speed	Veloc. picadora/Mincer speed	Capacidad/Capacity	Dimensiones/Sizes	Peso/Weight
69583	220-240 V; 50/60 Hz	1000 W	5	128 - 540 r.p.m.	3.200 - 13.500 r.p.m.	41 - 172 r.p.m.	5,0 L	32,5x25x36,5 cm	6,35Kg
69683	220-240 V; 50/60 Hz	1500 W	6	117 - 606 r.p.m.	2.600 - 13.500 r.p.m.	37 - 195 r.p.m.	6,0 L	40x25,5x33,5 cm	7,00 Kg

· Semiprofessional use ·
3 en 1

- Amasado con movimientos planetarios. Doble movimiento de giro, rotatorio y orbital. Mecanismo de engranajes metálicos.
- Brazo basculante de 35° para acoplar los distintos accesorios.
- Bol de acero inoxidable 18/10 de 5 L (69583) / 6 L (69683) de capacidad.
- Tapa transparente antisalpicaduras con ventana para añadir ingredientes durante el uso.
- 3 accesorios para batir, mezclar y amasar. Recubrimiento antiadherente de los accesorios mezclador y amasador para evitar que los alimentos se peguen.
- Ventosas de sujeción para una perfecta estabilidad.
- Accesorios no incluidos (jarra y picadora) compatibles para conseguir un robot multifuncional.

- Pétrissage avec des mouvements planétaires. Double mouvement de rotation, rotatoire et orbital. Mécanisme d'engrenages métalliques.
- Bras pivotant de 35° pour fixer aisément les différents accessoires.
- Bol en acier inoxydable 18/10 d'une capacité de 5 L (69583) / 6 L (69683).
- Couvercle transparent anti-éclaboussures avec fenêtre pour ajouter les ingrédients pendant l'utilisation.
- 3 accessoires pour battre, mixer et pétrir. Revêtement antiadhésif de l'accessoire pour mélanger et pétrir afin d'éviter que les aliments collent.
- Ventouses de fixation pour une bonne stabilité.
- Accessoires non inclus (jug and mincer) compatibles pour obtenir un robot multifonctions.

- Mixer with planetary motion. Twin twisting, rotational and orbital movement. Mechanism of metal gears.
- 35° swing arm for connection of different accessories.
- 18/10 stainless steel bowl with 5 L (69583) / 6 L (69683) capacity.
- Transparent anti-splatter lid with opening for adding ingredients during use.
- 3 accessories for whisking, mixing and kneading. Non-stick coating on the mixer and kneading accessories to prevent food from sticking.
- Suction pads for good stability.
- Non included accessories (jug and mincer) can be added to create a multifunctional kitchen robot.

BATIDOS · CÓCTELES

Batidora

Professional use



Batidora
Batteur · Mixer
Blender · Batedeira

Ref	€	U.Venta
69111	282,30	1

- Batidora ideal para elaborar batidos y cócteles.
- Con soporte para enganchar el vaso batidor.
- Interruptor par control de velocidad.
- Vaso en de acero inoxidable con capacidad de 0,6 litros.

- Mixeur idéal pour préparer des smoothies et des cocktails.
- Avec un support pour fixer le gobelet du mixeur.
- Interrupteur pour le contrôle de la vitesse.
- Gobelet en acier inoxydable d'une capacité de 0,6 litre.

- Ideal blender for making smoothies and cocktails.
- With a holder for attaching the blender beaker.
- Switch for speed control.
- Stainless steel beaker with a capacity of 0.6 litres.

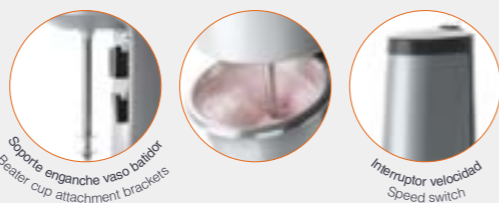

Soporte enganche vaso batidor
Beater cup attachment brackets

Interruptor velocidad
Speed switch

Ref	Tensión/Voltage	Potencia/Power	Velocidad/Speed	Capacidad/Capacity	Dimensiones/Sizes	Peso/Weight
69111	220-240 V / 50-60 Hz	400 W	10.000 - 15.000 r.p.m.	0,60 L	21x15x51 cm	6,20 Kg



BATIDORES VARILLAS

Colección

Household use



Varillas batidoras · Beater rods

Varillas amasadoras · Dough rods

ES

- Ideal para batir, mezclar y amasar fácilmente todo tipo de preparaciones reposteras de manera fácil y eficiente.
- Potente, silencioso y ligero para una mayor comodidad durante el uso.
- Empuñadura ergonómica; permite realizar la mezcla de manera segura y firme.
- Incluye 2 varillas batidoras y 2 varillas amasadoras.
- Extrae las varillas fácilmente con el botón de expulsión.

FR

- Idéal pour battre, mélanger et pétrir facilement tout type de préparations pâtisseries de façon facile et efficace.
- Puissant, silencieux et léger pour une plus grande praticité d'utilisation.
- Manche ergonomique ; qui permet de réaliser le mélange de façon sûre et nette.
- Inclut 2 fouets pour battre et 2 fouets pour pétrir.
- Extraction des fouets facile avec le bouton d'expulsion.

EN

- It's perfect for whipping, mixing and kneading all kinds of confectionery preparations quickly and easily.
- It's powerful, quiet and lightweight for greater comfort during use.
- The ergonomic handle lets you do the mixture safely and firmly.
- Two whisks and two kneading paddles included.
- Remove the accessories easily with the eject button.



Batidora de varillas HOME

Batteur à main · Handmixer
Hand mixer · Batedor de mão

Ref	€	W	U.Venta
69384	47,10	300	1



Batidora de varillas TitanPro

Batteur à main · Handmixer
Hand mixer · Batedor de mão

Ref	€	W	U.Venta
69374	52,90	350	1

Display incorporado; indica la velocidad seleccionada y el tiempo de uso
The built-in display shows the selected speed and usage time

Ref	Tensión/Voltage	Potencia/Power	Velocidad/Speed	Capacidad/Capacity	Dimensiones/Sizes	Peso/Weight
69384	220-240 V; 50/60 Hz	300 W	5 + TURBO	1000 g	18x8x14 cm	1,20 Kg
69374	220-240 V; 50/60 Hz	350 W	5 + TURBO	1000 g	14,5x8,5x19 cm	1,25 Kg

BRISK

Batidora Profesional

Professional use



Rápida · Fast
Eficiente · Efficient
Robusta · Robust

ES

- Fabricado en materiales altamente resistentes y de máxima calidad.
- El mango ergonómico ofrece mayor seguridad y control de la batidora.
- Indicado para trabajar en ollas de hasta 10 litros de capacidad.
- Los brazos trituradores, batidores y cuchillas, fabricados en acero inoxidable.
- Colocación y desmontaje sencillo e instantáneo, sin necesidad de utilizar herramientas.
- Prepara purés, cremas y todo tipo de salsas.

FR

- Fabriqué avec des matériaux hautement résistants et d'une qualité maximale.
- Le manche ergonomique offre une sécurité et un contrôle accru du mixeur.
- Indiqué pour travailler dans des marmites de jusqu'à 10 litres de contenance.
- Accessoires pour hacher, mixer, couper, fabriqués en acier inoxydable.
- Installation et démontage simple et instantané, sans utilisation d'outils supplémentaires.
- Permet de préparer des purées, des crèmes et tout type de sauces.

EN

- Made from highly resistant materials of the highest quality.
- The ergonomic handle provides greater safety and control of the blender.
- Suitable for working in pots up to 10 litres.
- The shredders, beaters and blades are made of stainless steel.
- Fitting and removing is simple and instant, without using tools.
- Prepare soups, purées and all kinds of sauces.

Botón de uso continuo
Continuous use button



Regulador de velocidad variable
Variable speed controller



Brazo de fácil desmontaje en acero inoxidable
Easy to remove arm made of stainless steel



Cuchilla de gran calidad para un óptimo trabajo
High-quality blade for optimum work

Serie 270

Batidora para uso discontinuo · Mixeur pour une utilisation discontinue · Blender for discontinuous use

Velocidad Fija · Fixed Speed



Batidor velocidad fija

Mixer vitesse fixe · Profi-mixer, Festdrehzahl
Immersion blender fixed speed · Batedeira velocidade fixa

Ref	€	W	U.Venta
69722	230,80	270	1

Velocidad Variable · Variable Speed



Regulador de velocidad variable
Variable speed controller

Batidor velocidad variable

Mixer vitesse variable · Profi-mixer, variable Geschwindigkeit
Immersion blender variable speed · Batedeira velocidade variável

Ref	€	W	U.Venta
69723	246,80	270	1

Ref	Tensión/Voltage	Potencia/Power	Velocidad/Speed	Capacidad/Capacity	L.Brazo/Arm length	Peso/Weight
69722	220-240 V; 50/60 Hz	270 W	20.000 r.p.m	10 L	16 cm	1,50 Kg
69723	220-240 V; 50/60 Hz	270 W	4.000 - 20.000 r.p.m	10 L	16 cm	1,50 Kg

Accesorios · Accessoires · Accessories



Brazo triturador

Pied mixeur · Rohr
Shaft tube · Pé triturador

Ref	€	L (cm)	U.Venta
69816	117,40	16	1



Brazo batidor

Fouet mélangeur · Rührbesen
Whisk · Pé amassadora

Ref	€	L (cm)	U.Venta
69815	164,00	18,5	1



Para serie 220 · For 220 series

Set llaves desmontaje cuchillas

Outil demontage lame set · Schüsselsatz zum Wechseln der Messer
Blade disassembly tool set · Set ferrament desmontagem lâmina

Ref	€	U.Venta
R69722J	10,90	1

Inox 18/10

Incluye tacos y tornillos para su instalación
Includes studs and screws for installation

A

B



Soporte batidora BRISK

Support mélangeur · Aufhängeleiste für Mixer
Blender stand · Suporte para batedeira

	Ref	€	L (cm)	h (cm)	ØVarilla (mm)	U.Venta
A	69801	8,80	7	5,5	5,0	1 Individual
B	69803	16,50	28	5,5	5,0	1 Triple

Serie 350

Batidora para uso continuo · Mixeur pour une utilisation continue · Blender for continuous use

Velocidad Fija · Fixed Speed



Batidor velocidad fija

Mixer vitesse fixe · Profi-mixer, Festdrehzahl
Immersion blender fixed speed · Batedeira velocidade fixa

	Ref	€	Brazo (cm)	U.Venta
A	69761	301,50	20	1
B	69762	314,20	25	1
C	69763	326,80	30	1
D	69764	345,70	40	1
E	69765	370,70	50	1

Velocidad Variable · Variable Speed

Regulador de velocidad variable
Variable speed controller



Batidor velocidad variable

Mixer vitesse variable · Profi-mixer, variable Geschwindigkeit
Immersion blender variable speed · Batedeira velocidade variável

	Ref	€	Brazo (cm)	U.Venta
A	69771	318,00	20	1
B	69772	330,60	25	1
C	69773	343,10	30	1
D	69774	361,80	40	1
E	69775	386,90	50	1



Ref	Tensión/Voltage	Potencia/Power	Velocidad/Speed	Capacidad/Capacity	L.Brazo/Arm length	Composición/Comp.	Peso/Weight
69761	220-240 V / 50-60 Hz	350 W	16.000 r.p.m	15 L	20 cm	69735: Motor/Motor 69820: Brazo/Arm	2,95 Kg
69762	220-240 V / 50-60 Hz	350 W	16.000 r.p.m	20 L	25 cm	69735: Motor/Motor 69825: Brazo/Arm	3,00 Kg
69763	220-240 V / 50-60 Hz	350 W	16.000 r.p.m	30 L	30 cm	69735: Motor/Motor 69830: Brazo/Arm	3,80 Kg
69764	220-240 V / 50-60 Hz	350 W	16.000 r.p.m	80 L	40 cm	69735: Motor/Motor 69840: Brazo/Arm	4,00 Kg
69765	220-240 V / 50-60 Hz	350 W	16.000 r.p.m	120 L	50 cm	69735: Motor/Motor 69850: Brazo/Arm	4,20 Kg
69771	220-240 V / 50-60 Hz	350 W	4.000 - 16.000 r.p.m	15 L	20 cm	69736: Motor/Motor 69820: Brazo/Arm	2,95 Kg
69772	220-240 V / 50-60 Hz	350 W	4.000 - 16.000 r.p.m	20 L	25 cm	69736: Motor/Motor 69825: Brazo/Arm	3,00 Kg
69773	220-240 V / 50-60 Hz	350 W	4.000 - 16.000 r.p.m	30 L	30 cm	69736: Motor/Motor 69830: Brazo/Arm	3,80 Kg
69774	220-240 V / 50-60 Hz	350 W	4.000 - 16.000 r.p.m	80 L	40 cm	69736: Motor/Motor 69840: Brazo/Arm	4,00 Kg
69775	220-240 V / 50-60 Hz	350 W	4.000 - 16.000 r.p.m	120 L	50 cm	69736: Motor/Motor 69850: Brazo/Arm	4,20 Kg

Serie 500

Batidora para uso continuo e intensivo · Mixeur pour une utilisation continue et intensive · Blender for continuous and intensive use

Velocidad Fija · Fixed Speed



Batidor velocidad fija

Mixer vitesse fixe · Profi-mixer, Festdrehzahl
Immersion blender fixed speed · Batedeira velocidade fixa

	Ref	€	Brazo (cm)	U.Venta
A	69781	318,70	20	1
B	69782	331,30	25	1
C	69783	343,90	30	1
D	69784	362,60	40	1
E	69785	387,70	50	1

Velocidad Variable · Variable Speed

Regulador de velocidad variable
Variable speed controller



Batidor velocidad variable

Mixer vitesse variable · Profi-mixer, variable Geschwindigkeit
Immersion blender variable speed · Batedeira velocidade variável

	Ref	€	Brazo (cm)	U.Venta
A	69791	333,20	20	1
B	69792	345,80	25	1
C	69793	358,20	30	1
D	69794	377,00	40	1
E	69795	402,10	50	1



Ref	Tensión/Voltage	Potencia/Power	Velocidad/Speed	Capacidad/Capacity	L.Brazo/Arm length	Composición/Comp.	Peso/Weight
69781	220-240 V / 50-60 Hz	500 W	16.000 r.p.m	30 L	20 cm	69750: Motor/Motor 69820: Brazo/Arm	3,55 Kg
69782	220-240 V / 50-60 Hz	500 W	16.000 r.p.m	40 L	25 cm	69750: Motor/Motor 69825: Brazo/Arm	3,60 Kg
69783	220-240 V / 50-60 Hz	500 W	16.000 r.p.m	60 L	30 cm	69750: Motor/Motor 69830: Brazo/Arm	4,40 Kg
69784	220-240 V / 50-60 Hz	500 W	16.000 r.p.m	100 L	40 cm	69750: Motor/Motor 69840: Brazo/Arm	4,60 Kg
69785	220-240 V / 50-60 Hz	500 W	16.000 r.p.m	140 L	50 cm	69750: Motor/Motor 69850: Brazo/Arm	4,80 Kg
69791	220-240 V / 50-60 Hz	500 W	4.000 - 16.000 r.p.m	30 L	20 cm	69751: Motor/Motor 69820: Brazo/Arm	3,55 Kg
69792	220-240 V / 50-60 Hz	500 W	4.000 - 16.000 r.p.m	40 L	25 cm	69751: Motor/Motor 69825: Brazo/Arm	3,60 Kg
69793	220-240 V / 50-60 Hz	500 W	4.000 - 16.000 r.p.m	60 L	30 cm	69751: Motor/Motor 69830: Brazo/Arm	4,40 Kg
69794	220-240 V / 50-60 Hz	500 W	4.000 - 16.000 r.p.m	100 L	40 cm	69751: Motor/Motor 69840: Brazo/Arm	4,60 Kg
69795	220-240 V / 50-60 Hz	500 W	4.000 - 16.000 r.p.m	140 L	50 cm	69751: Motor/Motor 69850: Brazo/Arm	4,80 Kg

Serie 350

Serie 500



Motor batidor SERIE 350

Moteur mixer SÉRIE 350 · Mixer Motor, SERIE 350
Immersion blender motor, SERIE 350 · Motor bateadeira SÉRIE 350

	Ref	€	W	U.Venta	
A	69735	170,00	350	1	Velocidad Fija · Fixed Speed
B	69736	186,20	350	1	Velocidad Variable · Variable Speed

Motor batidor SERIE 500

Moteur mixer SÉRIE 500 · Mixer Motor, SERIE 500
Immersion blender motor SERIE 500 · Motor bateadeira SÉRIE 500

	Ref	€	W	U.Venta	
A	69750	186,90	500	1	Velocidad Fija · Fixed Speed
B	69751	201,40	500	1	Velocidad Variable · Variable Speed

Brazo triturador

Pied mixeur · Rohr
Shaft tube · Pé triturador

	Ref	€	L (cm)	A (cm)	U.Venta
A	69820	131,80	20	12,5	1
B	69825	144,40	25	15,8	1
C	69830	156,80	30	19,2	1
D	69840	175,60	40	25,8	1
E	69850	200,70	50	32,5	1
F	69824	182,00	25	-	1

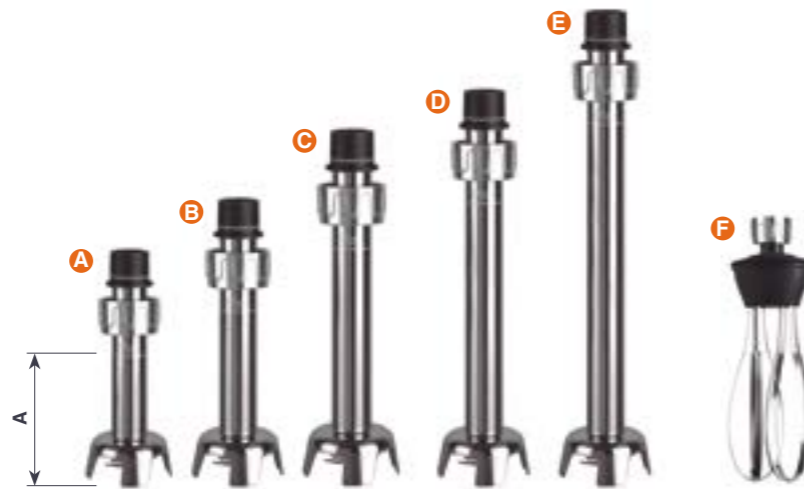

Para serie 350/500 · For 350/500 series



Set llaves desmontaje cuchillas

Outil montage lame set · Schüsselsatz zum Wechseln der Messer
Blade disassembly tool set · Set ferrament desmontagem lâmina

Ref	€	U.Venta
R69735J	10,90	1



Incluye tacos y tornillos para su instalación
Includes studs and screws for installation



Soporte batidora BRISK

Support mélangeur · Aufhängeleiste für Mixer
Blender stand · Suporte para bateadeira

	Ref	€	L (cm)	h (cm)	ØVarilla (mm)	U.Venta
A	69801	8,80	7	5,5	5,0	1 Individual
B	69803	16,50	28	5,5	5,0	1 Triple

BAMIX Batidora

Professional use



bamix®



Incluye soporte pared para colgar
Includes wall mount for hanging

Cuchillas exclusivas de alto rendimiento
Exclusive high performance blades

Batidora BAMIX

Mixer · Mixer
Mixer · Bateadeira

Ref	€	U.Venta
61672	330,40	1
61673	516,10	1

Ref	Tensión/Voltage	Potencia/Power	Velocidad/Speed	Inmersión/Inmersion	Altura/Height
61672	220-240 V / 50-60 Hz	200 W	14.000 - 18.000 r.p.m.	25 cm	39,5 cm
61673	220-240 V / 50-60 Hz	350 W	18.000 - 22.000 r.p.m.	35 cm	49,5 cm

- Permite montar, batir, mezclar, triturar y picar todo tipo de frutas y verduras, así como picar hielo, gracias a sus cuchillas.
- Batidora de precisión y alta calidad.
- Permite trabajar con ella largo tiempo sin que se caliente.
- Mango diseñado para adaptarse a la mano.
- 2 posiciones:
I : se utiliza con cantidades pequeñas, para preparados ligeros y esponjosos.
II : se usa para cantidades más grandes e ingredientes viscosos y consistentes.
- Permet de monter, battre, mélanger, triturer et émincer tout type de fruits et légumes, ainsi que de piler la glace, grâce à ses lames.
- Mélangeur de précision de haute qualité.
- Vous permet de travailler avec lui pendant longtemps sans qu'il chauffe.
- Poignée conçue pour s'adapter à la main.
- 2 postes :
I : utilisé en petites quantités, pour des préparations légères et moelleuses.
II : utilisé pour de plus grandes quantités et des ingrédients visqueux et consistants.
- It enables assembly, beating, mixing, crushing, and chopping of all type of fruits, vegetables, and ice, thanks to its blades.
- High quality precision mixer.
- Allows you to work with it for a long time without it getting hot.
- Handle designed to fit the hand.
- 2 positions:
I : used with small amounts, for light and fluffy preparations.
II : used for larger quantities and viscous and consistent ingredients.

Accesorios · Accessoires · Accessories



Cuchilla para carne

lame à viande · Klinge für Fleisch
Blade for meat · Lâminar para carne

Ref	€	U.Venta
R61672D	20,20	1



Grupo pulverizador

Broyeur · Mahleinheit
Pulverizing unit · Conjunto pulverizador

Ref	€	ml	U.Venta
61674	47,30	250	1



Grupo cortador

Combiné râpeur · Schneide-/Zubereitungseinheit
Cutting/preparing unit · Conjunto cortador

Ref	€	ml	U.Venta
61675	194,20	500	1

5 Funciones
Functions

FAST Batidora

Household use



Cuchillas exclusivas de alto rendimiento
Exclusive high performance blades

- Permite montar, batir, mezclar, triturar y picar todo tipo de frutas y verduras, así como picar hielo.
- Prepara salsas, batidos, papillas y cremas gracias a sus 4 cuchillas intercambiables (incluye llave para cambiar las cuchillas).
- 2 velocidades: SLOW/TURBO. Profundidad del brazo: 23 cm.
- Incluye un recipiente mezclador de 500, libre de BPA.

- Permet de monter, battre, mélanger, triturer et émincer tout type de fruits et légumes, ainsi que de piler la glace.
- Prépare des sauces, des smoothies, des bouillies et des crèmes grâce à ses 4 lames interchangeable (inclut une clé pour changer les lames).
- 2 vitesses : SLOW/TURBO. Profondeur du bras : 23 cm.
- Inclut un récipient pour mélanger de 500 ml, sans BPA.

- It enables assembly, beating, mixing, crushing, and chopping of all type of fruits, vegetables, and ice.
- Prepare sauces, smoothies, mashes, and creams with its 4 interchangeable blades (includes wrench to change blades).
- 2 speeds: SLOW/TURBO. Arm Depth: 23 cm.
- Includes a mixing container of 500 ml, BPA free.



Batidora FAST

Mixeur · Mixer
Blender · Batedeira

Ref	€	W	U.Venta
61681	74,90	700	1



Cuchillas exclusivas de alto rendimiento
Exclusive high performance blades

Batidora picadora FAST

Mixeur hacheur · Mixer und Fleischwolf
Blender chopper · Batedeira picadora

Ref	€	W	U.Venta
61671	85,60	700	1



Picadora

Hachoir · Fleischwolf
Mincer · Picadora

Ref	€	ml	U.Venta
R61671A	12,30	750	1

Incluida en la Ref.: 61671 · Included in Ref.: 61671

Ref	Tensión/Voltage	Potencia/Power	Velocidad/Speed	Capacidad/Capacity	Velocidad/Speed	L.brazo/Shaft leng	Peso/Weight
61681	220-240 V; 50/60 Hz	700 W	9.000 - 16.000 r.p.m.	500 ml (Glass)	SLOW / TURBO	23 cm	1,10 Kg
61671	220-240 V; 50/60 Hz	700 W	9.000 - 16.000 r.p.m.	750 ml (mincer) / 500 ml (Glass)	SLOW / TURBO	23 cm	1,45 Kg

PREMIUM Batidora

Household use



Resultados más finos y uniformes
Finer and more even blending



Botón de bloqueo
Regulador de velocidad
Lock button
Speed regulator button



Indicadores LED de velocidad
LED speed indicator light



Superficie GRIP Technology
Surface with GRIP technology



Fácil montaje
Easy assembly



Antisalpicaduras
Anti-splash housing



Cuchillas afiladas
Sharp blades

- PressSystem: ejerza más o menos presión sobre el botón de regulador de velocidad para aumentar o disminuir la velocidad y obtener la textura deseada.
- Pulsando el botón hasta el fondo el batidor funcionará a máxima velocidad.
- El nivel de velocidad se verá reflejado en el encendido de los indicadores LED.
- 4 cuchillas de acero inoxidable de máxima calidad: dos rectas y dos curvas para un rendimiento óptimo y profesional.
- Cierre bayoneta: fijación ultrarrápida y sencilla; bloquea y desbloquea el pie con un solo giro garantizando una fijación 100% segura.
- Fácil limpieza: vaso apto para el lavavajillas.
- Compacto y ergonómico: mango antideslizante.

- PressSystem: exercez une pression plus ou moins importante sur le bouton de régulation de vitesse pour augmenter ou réduire la vitesse et obtenir la texture souhaitée. En appuyant à fond sur le bouton, le mixeur fonctionnera à la vitesse maximale.
- Le niveau de vitesse se reflètera sur l'allumage des indicateurs lumineux.
- 4 lames en acier inoxydable de la plus grande qualité : deux droites et deux courbées pour un rendement optimal et professionnel.
- Fermeture à baïonnette : fixation ultra rapide et simple; bloque et débloque le pied d'une seule rotation et garantit une fixation 100% sûre.
- Facile à nettoyer : le bol passe au lave-vaisselle.
- Compact et ergonomique : manche antidérapant.

- PressSystem: Apply more or less pressure to the speed regulator button to increase or decrease the speed to get the texture you want. Press the button as far as it goes for maximum speed.
- The speed level is shown by the LED indicator.
- Four top quality stainless steel blades: two straight and two curved blades for optimum professional performance.
- Bayonet latch: the ultra-fast and easy attachment locks and unlocks the blending arm with a simple twist and guarantees a 100% secure hold.
- Easy to clean: the pitcher is dishwasher safe.
- Compact and ergonomic: non-slip handle.



Batidora PREMIUM

Mixer · Mixer
Mixer · Batedeira

Ref	€	W	U.Venta
61678	63,70	1000	1



Batidor varillas

Fouet multibrins · Schneebeesen
Wire whisk · Batedeira varetas

Ref	€	L (cm)	U.Venta
R61678L	5,60	23	1



Picadora

Hachoir · Fleischwolf
Mincer · Picadora

Ref	€	ml	U.Venta
R61678K	10,80	500	1

Ref	Tensión/Voltage	Potencia/Power	Velocidad/Speed	Cap. contenedor/Container cap.	Dimensiones/Sizes	Peso/Weight
61678	220-240 V; 50/60 Hz	1000 W	16.000 r.p.m. (max)	800 ml (28 oz)	5,5x6,5x41 cm	0,960 Kg

PRO Batidora

· Household use ·



Resultados más finos y uniformes
Finer and more even blending



Regulador de velocidad
Speed regulator

TURBO
Máxima potencia
Maximum power

Fácil montaje / desmontaje
Easy assembly / disassembly



Cuchillas afiladas
Sharp blades

Antisalpicaduras
Anti-splash housing

Mango ergonómico
Ergonomic handle

- **FUNCIÓN SELF-SPEED.** Permite regular la velocidad de giro de la cuchilla.
- **4 cuchillas de acero inoxidable de gran durabilidad:** dos rectas y dos curvas para un óptimo rendimiento.
- **Pie batidor de 21 cm de longitud y fabricado en acero inoxidable 18/10.**
- **El sistema de anclaje tipo rosca disminuye las vibraciones durante el uso.**
- **Incluye vaso mezclador con base antideslizante de 800 ml, marcado en ml/cups y libre de BPA.**
- **Accesorios aptos para el lavavajillas.**

- **FONCTION SELF-SPEED.** Permet de régler la vitesse de rotation de la lame.
- **4 lames en acier inoxydable d'une grande durabilité :** deux droites et deux courbées pour un rendement optimal.
- **Pied mixeur de 21 cm de longueur fabriqué en acier inoxydable 18/10.**
- **Le système d'ancrage de type fileté réduit les vibrations pendant l'utilisation.**
- **Inclut un verre mélangeur avec une base antidérapante de 800 ml, avec des marques en ml/cups et sans bisphénol A.**
- **Accessoires aptes pour le lave-vaisselle.**

- **SELF-SPEED FUNCTION.** Enables you to control the speed at which the blade rotates.
- **4 highly durable stainless steel blades:** two straight and two curved for optimum performance.
- **21cm blending arm made of 18/10 stainless steel.**
- **The screw-type attachment system reduces vibrations during use.**
- **Includes 800ml BPA-free mixing beaker with anti-slip base, marked in ml/cups.**
- **Dishwasher-safe accessories.**



Batidora PRO
Mixer · Mixer
Mixer · Batedeira

Ref	€	W	U.Venta
A 61682	68,70	1000	1
B 61683	76,80	1000	1

Picadora incluida
Mincer included



Batidor varillas
Fouet multibrins · Schneebesen
Wire whisk · Batedeira varetas

Ref	€	L (cm)	U.Venta
R61682B	7,30	20	1



Picadora
Hachoir · Fleischwolf
Mincer · Picadora

Ref	€	ml	U.Venta
R61682A	12,60	500	1

Incluida en la Ref.: 61683
Included in Ref.: 61683

Ref	Tensión/Voltage	Potencia/Power	Velocidad/Speed	Vaso/Glass	Picadora/Mincer	Dimensiones/Sizes	Peso/Weight
61682	220-240 V; 50/60 Hz	1000 W	13.050 - 15.950 r.p.m.	800 ml (28 oz)	-	Ø6,3 x 41,2 cm	0,805 Kg
61683	220-240 V; 50/60 Hz	1000 W	13.050 - 15.950 r.p.m.	800 ml (28 oz)	500 ml	Ø6,3 x 41,2 cm	1,200 Kg

MIX Batidora

· Household use ·



Resultados más finos y uniformes
Finer and more even blending



Regulador de velocidad
Speed regulator

TURBO
Máxima potencia
Maximum power

Fácil montaje / desmontaje
Easy assembly / disassembly



Cuchillas afiladas
Sharp blades

Antisalpicaduras
Anti-splash housing

SOFT TOUCH
Mango ergonómico
Ergonomic handle

- **Dispone de una ruleta de fácil manejo para ajustar la velocidad y obtener la textura deseada.**
- **4 cuchillas de acero inoxidable de gran durabilidad:** dos rectas y dos curvas para un óptimo rendimiento. Sistema antisalpicaduras.
- **Pie batidor de 21 cm de acero inoxidable desmontable de fácil colocación que facilita su almacenamiento y limpieza.**
- **Incluye un recipiente mezclador de 800 ml (marcado en ml /oz), libre de BPA.**
- **Vaso apto para el lavavajillas.**

- **Dispose d'une roulette facile à utiliser pour ajuster la vitesse et obtenir la texture souhaitée.**
- **4 lames en acier inoxydable d'une grande durabilité :** deux droites et deux courbées pour un rendement optimal. Système anti-éclaboussures.
- **Pied mixeur de 21 cm en acier inoxydable démontable facile à installer qui facilite le rangement et le nettoyage.**
- **Inclut un récipient pour mélanger de 800 ml (avec marques en ml /oz), sans bisphénol A.**
- **Bol apte pour le lave-vaisselle.**

- **It has an easy-to-use wheel to adjust the speed and obtain the desired texture.**
- **4 highly durable stainless steel blades:** two straight and two curved for optimum performance. Anti-splash system.
- **The 21cm stainless steel blender stick is easy to attach and removable for easy storage and cleaning.**
- **Includes an 800ml BPA-free mixing bowl (marked in ml/oz).**
- **The glass is dishwasher safe.**



Batidora MIX
Mixer · Mixer
Mixer · Batedeira

Ref	€	W	U.Venta
61679	60,90	1200	1



Batidor varillas
Fouet multibrins · Schneebesen
Wire whisk · Batedeira varetas

Ref	€	L (cm)	U.Venta
R61679AB	6,80	23	1



Picadora
Hachoir · Fleischwolf
Mincer · Picadora

Ref	€	ml	U.Venta
R61679AA	12,10	800	1

Ref	Tensión/Voltage	Potencia/Power	Velocidad/Speed	Cap. contenedor/Container cap.	Dimensiones/Sizes	Peso/Weight
61679	220-240 V; 50/60 Hz	1200 W	13.000 - 15.300 r.p.m.	800 ml (28 oz)	Ø6,5 x 41 cm	0,930 Kg

TitanPro Batidora

· Household use ·



Resultados más finos y uniformes
Finer and more even blending



Regulador de velocidad
Speed regulator

TURBO
Máxima potencia
Maximum power

Fácil montaje / desmontaje
Easy assembly / disassembly



Cuchillas afiladas
Sharp blades

Antisplachaduras
Anti-splash housing



Batidora TitanPro
Mixer · Mixer
Mixer · Batedeira

Ref	€	W	U.Venta
A 61668	46,40	600	1
B 61669	59,20	600	1

Picadora incluida
Mincer included

- **Velocidad variable:** dispone de un regulador de velocidad (1 - 5 velocidades) de fácil manejo para ajustar la velocidad y obtener la textura deseada.
- **Función TURBO:** máxima potencia para resultados rápidos, homogéneos e inmejorables.
- **4 cuchillas de acero inoxidable de máxima calidad:** dos rectas y dos curvas para un rendimiento óptimo y profesional.
- **Cierre bayoneta:** fijación ultrarrápida y sencilla; bloquea y desbloquea el pie con un solo giro garantizando una fijación 100% segura.
- **Fácil limpieza:** vaso apto para el lavavajillas.
- **Compacto y ergonómico:** mango antideslizante.

- **Vitesse variable :** dispose d'un régulateur de vitesse (1 - 5 vitesses) facile à utiliser pour régler la vitesse et obtenir la texture souhaitée.
- **Fonction TURBO :** puissance maximale pour des résultats rapides, homogènes et uniques.
- **4 lames en acier inoxydable de la plus grande qualité :** deux droites et deux courbées pour un rendement optimal et professionnel.
- **Fermeture à baïonnette :** fixation ultra rapide et simple; bloque et débloque le pied d'une seule rotation et garantit une fixation 100% sûre.
- **Facile à nettoyer :** le bol passe au lave-vaisselle.
- **Compact et ergonomique :** manche antidérapant.

- **Variable speed:** it has an easy to use speed regulator (1 - 5 speeds) for adjusting the speed to get the texture you want.
- **TURBO function:** maximum power for fast, homogeneous and unbeatable results.
- **Four top quality stainless steel blades:** two straight and two curved blades for optimum professional performance.
- **Bayonet latch:** the ultra-fast and easy attachment locks and unlocks the blending arm with a simple twist and guarantees a 100% secure hold.
- **Easy to clean:** the pitcher is dishwasher safe.
- **Compact and ergonomic:** non-slip handle.



Batidor varillas
Fouet multibrins · Schneebesen
Wire whisk · Batedeira varetas

Ref	€	L (cm)	U.Venta
R61668D	8,50	23,5	1



Picadora
Hachoir · Fleischwolf
Mincer · Picadora

Ref	€	ml	U.Venta
R61668C	17,00	500	1

Incluida en la Ref.: 61669
Included in Ref. : 61669

Ref	Tensión/Voltage	Potencia/Power	Velocidad/Speed	Vaso/Glass	Picadora/Mincer	Dimensiones/Sizes	Peso/Weight
61668	220-240 V; 50/60 Hz	600 W	15.000 r.p.m.	600 ml	-	8,5 x6,28x39,7 cm	0,845 Kg
61669	220-240 V; 50/60 Hz	600 W	15.000 r.p.m.	600 ml	500 ml	8,5 x6,28x39,7 cm	1,085 Kg

QUICK Picadora

· Professional use ·



Picadora profesional QUICK
Hachoir professionnel · Professioneller Zerkleinerer
Professional chopper · Picadora profesional

Ref	€	W	L	U.Venta
69490	980,80	735	3,0	1

- **Picadora profesional** que pica y tritura todo tipo de alimentos (verduras, hortalizas, carnes y frutos secos, etc.) de manera rápida y homogénea.
- **Contenedor extraíble** de acero inoxidable 18/10 de máxima calidad de 3 litros de capacidad.
- **Tapa de trítan transparente** totalmente extraíble con orificio para añadir ingredientes en marcha. Libre de BPA.
- **Cuchillas extraíbles** de acero inoxidable totalmente afiladas.
- **100% seguro:** evita la puesta en marcha si el contenedor o la tapa no están en la posición adecuada.
- **Dispone de protección** contra el sobrecalentamiento.
- **Encendido y apagado** con un solo clic mediante el botón ON / OFF.
- **Cubeta inclinada** para una fácil introducción y recogida de los alimentos.
- **Pies antideslizantes** para una máxima estabilidad.
- **Fácil limpieza.** Contenedor y tapa aptos para el lavavajillas.

- This professional chopper chops and crushes all kinds of food, like vegetables, greens, meat and nuts, quickly and evenly.
- It has a removable top quality 18/10 stainless steel container with a capacity of 3 litres.
- The transparent Tritan lid is completely removable and has a hole for adding ingredients while the chopper is running. It's BPA free.
- The removable stainless steel blades are completely sharpened.
- **100% Safe:** prevents starting if the lid or container are not in the right place.
- It has protection against overheating.
- It can be turned on and off with a single click using the ON / OFF button.
- The container is tilted so it's easy to put food in and take it out.
- It has non-slip feet for maximum stability.
- Easy to clean, the lid and container are dishwasher safe.

Ref	Tensión/Voltage	Potencia/Power	Velocidad/Speed	Cap. contenedor / Container cap.	Cuchillas (Ø) / Blades (Ø)	Orif. de entrada / Entry hole	Dimensiones/Sizes	Peso/Weight
69490	220-240 V ; 50/60 Hz	735 W	1500 r.p.m.	3,0 L	18,5 cm	5 cm	28,5x32x43 cm	14,20 Kg

QUARTZ Picadora

· Household use ·



2 velocidades
2 speeds

Cierre seguro
Secure closure

Cuchillas muy afiladas
Very sharp blades

Gran capacidad
Great capacity

Antideslizante
Anti-slip

Picadora de cristal QUARTZ
Hachoir en verre · Fleischwolf, glas
Glass mincer · Picadora de vidro

Ref	€	W	L	U.Venta
69077	45,40	300	1,2	1
69073	69,80	300	2,0	1

- **Picadora eléctrica compacta** que pica todo tipo de alimentos, como verduras, frutas, jengibre, ajo, cebolla, frutos secos y hierbas.
- **Cabezal de acero inoxidable** y recipiente de cristal de alta calidad.
- **Cuchillas ultrasresistentes.**
- **Gracias a los engranajes metálicos** permite un uso continuo.
- **Corta con precisión y homogéneamente.**
- **2 velocidades;** la más veloz para un corte rápido y la más lenta para un corte más controlado.
- **Base antideslizante** para facilitar la tarea y evitar desplazamientos.
- **Fácil de desmontar y limpiar.** Contenedor y cuchillas aptos para el lavavajillas.

- Compact electric mincer that processes all kinds of food, such as vegetables, fruit, ginger, garlic, onions, dried fruit and herbs.
- Stainless steel head and high-quality glass container.
- High-strength blades.
- Its metal gears mean it can withstand longer continuous use.
- High-precision, even cutting.
- 2 speeds: fast for rapid cutting and slow for more controlled cutting.
- Non-slip base for easier use with no movement.
- Easy to disassemble for cleaning Dishwasher-proof container and blades.



Ref	Tensión/Voltage	Potencia/Power	Nºcuchillas/Blades	Øcuchillas/Blades	Capacidad/Cap.	Dimensiones/Sizes	Peso/Weight
69077	220-240 V ; 50/60 Hz	300 W	4	10,5 cm	1,2 L	18,7x16x25 cm	1,60 Kg
69073	220-240 V ; 50/60 Hz	300 W	4	12,0 cm	2,0 L	21x17,5x27 cm	2,10 Kg

PICADORAS CARNE

Colección

· Semiprofessional use ·



ES

- Picadoras estables y resistentes.
- Engranajes interiores y exteriores metálicos para una mayor resistencia.
- Incluyen 3 discos perforados de acero inoxidable.
- Incluyen 4 accesorios extra (Kibbe incluido).
- Totalmente desmontables para facilitar su limpieza.

FR

- Hachoirs stables et résistants.
- Engrainages intérieurs et extérieurs métalliques pour une plus grande résistance.
- Inclut 3 disques perforés en acier inoxydable.
- Inclut 4 accessoires supplémentaires (kebbeh inclus).
- Totalemment démontable pour faciliter son nettoyage.

EN

- Stable and resistant choppers.
- Interior and exterior metal gear teeth for improved resistance.
- Includes 3 stainless steel perforated discs.
- Includes 4 extra accessories (Kibbe included).
- Can be fully disassembled for easy cleaning.



3 discos perforados
3 stainless steel perforated discs



Embutidos (salchichas, chorizo...)
Sausages (salchicha, chorizo...)



Kibbe
kibbe

· Professional use ·

Productividad
2 kg/min
Productivity

Productividad
1 kg/min
Productivity

Productividad
1 kg/min
Productivity



Picadora de carne PRO

Hachoir pour viande · Fleischwolf
Meat mincer · Picadora de carne

Ref	€	W	U.Venta
69368	596,30	550	1



Picadora de carne STRONG

Hachoir pour viande · Fleischwolf
Meat mincer · Picadora de carne

Ref	€	W	U.Venta
69068	234,00	800	1



Picadora de carne CHOP

Hachoir pour viande · Fleischwolf
Meat mincer · Picadora de carne

Ref	€	W	U.Venta
69369	117,30	300	1

Ref	Tensión/Voltage	Potencia/Power	Par motor/Motor torque	Velocidad/Speed	Capacidad/Capacity	Dimensiones/Sizes	Peso/Weight
69368	220-240 V; 50 Hz	550 W	1,27 Nm	240 r.p.m	2 Kg/min	53,5x26x35 cm	11,0 Kg
69068	220-240 V; 50 Hz	800 W	0,25 Nm		1 Kg/min	35x18x36 cm	5,09 Kg
69369	220-240 V; 50/60 Hz	300 W	0,14 Nm		1 Kg/min	38,6x16,6x34,2 cm	3,70 Kg

CORTADORAS FIAMBRE

Colección



Professional use

- Cortadora eléctrica de alto rendimiento.
- Corta sin esfuerzo y con una gran precisión.
- Cuchilla desmontable de acero inoxidable de gran calidad.
- Regulador de grosor de corte entre 0 y 11/13 mm.
- Estructura de aluminio, transmisión por correa, pantalla protectora y cabezalajustable de suave deslizamiento.
- Cuenta con un alador extraíble para ayudar al mantenimiento de la cuchilla.

- Trancheuse électrique à haut rendement.
- Coupe sans efforts et avec une grande précision.
- Lame démontable en acier inoxydable de grande qualité.
- Régulateur d'épaisseur de découpe entre 0 et 11/13 mm.
- Structure en aluminium, transmission par courroie, paroi de protection et tête ajustable à glissement doux.
- Dispose d'un aiguiseur extractible pour aider à l'entretien de la lame.

- High performance electric cutter.
- Cuts effortlessly and with high precision.
- High quality removable stainless steel blade.
- Cut thickness regulator between 0 and 11/13 mm.
- Aluminium structure, belt driven, protective screen and adjustable smooth sliding head.
- It has a removable sharpener to help with blade maintenance.

Household use

- Cortafiambres eléctrico metálico con acabados en acero inoxidable.
- Cuchilla ultrarresistente y desmontable de acero inoxidable de Ø19 cm con puntas onduladas diseñada para cortar carne, embutido, queso, etc.
- Grosor de corte ajustable de 0 - 15 mm.
- Bandeja inoxidable abatible y de fácil limpieza.
- Pantalla protectora y cabezal ajustable de suave deslizamiento.
- Transmisión por engranaje.
- Muy estable: cuatro ventosas que evitan el deslizamiento en el uso.

- Electric metal meat slicer with a stainless steel finish.
- Ultra strong 19 cm diameter removable stainless steel blade with wavy teeth.
- Designed to cut meat, processed meats, cheese, etc.
- Adjustable cut from 0-15 mm. Easy to clean folding stainless steel tray.
- Protective screen and smooth sliding adjustable head.
- Geared transmission.
- Very stable: four suction cups that prevent sliding during use.

Transmisión por correa
Belt drive



Cortadora de fiambre PROFESIONAL

Trancheuse de charcuterie · Aufschnittmaschine
Cold meat cutter · Cortadora de fiambre

Ref	€	W	U.Venta
69125	660,30	150	1
69130	1128,00	250	1

Ref	Tensión/Voltage	Potencia/Power	Cuchilla/Blade	Esp. corte/Slice thick.	Dimensiones/Sizes	Peso/Weight
69125	220-240 V; 50/60 Hz	150 W	Ø250 mm / 10"	0 - 11 mm	48x39x36 cm	15,0 Kg
69130	220-240 V; 50/60 Hz	250 W	Ø300 mm / 12"	0 - 13 mm	60x58x44 cm	24,3 Kg
69118	220-240 V; 50/60 Hz	150 W	Ø190 mm / 7 1/2"	0 - 15 mm	37,3x27,9x27,5 cm	4,51 Kg



Bandeja inoxidable abatible
Stainless steel tray



Transmisión por engranaje
Gear transmission



Grosor de corte ajustable de 0 - 15 mm
Adjustable cut from 0-15 mm



Cortadora de fiambre HOME

Trancheuse de charcuterie · Aufschnittmaschine
Cold meat cutter · Cortadora de fiambre

Ref	€	W	U.Venta
69118	118,10	150	1

PROFESIONAL

Cortador de verduras

Professional use



ES

- Cortador de verduras para uso profesional.
- Construida totalmente en aluminio anodizado de alta resistencia.
- Cuerpo superior abatible para facilitar la limpieza, el mantenimiento y la colocación de los discos de corte.
- 2 entradas para los diferentes tipos de verduras; entrada semicircular con palanca para alimentos voluminosos (patatas, tomates, cebollas, etc.) y entrada redonda con empujador para verduras y hortalizas más pequeñas (pepinos, calabacín, zanahorias, etc.).
- Incluye 5 cuchillas: dos discos de corte (2 y 4 mm) y tres discos para rallar (3, 5 y 7 mm).
- Funcionamiento continuo. Transmisión por correa.
- 2 sistemas de seguridad: tornillo de bloqueo de tapa y un sensor electromagnético (al abrir la tapa se apaga la máquina).
- 4 patas de goma para una mejor estabilidad.

FR

- Coupe-légumes à usage professionnel.
- Entièrement fabriqué en aluminium anodisé d'une grande résistance.
- Corps supérieur rabattable pour faciliter le nettoyage, l'entretien et l'installation des disques de coupe.
- 2 entrées pour les différents types de légumes : entrée semi-circulaire avec levier pour aliments volumineux (pommes de terre, tomates, oignons, etc.) et entrée ronde avec poussoir pour légumes classiques et plus petits (concombres, courgettes, carottes, etc.).
- Inclut 5 lames : deux disques pour couper (2 et 4 mm) et trois disques pour râper (3, 5 et 7 mm).
- Fonctionnement continu. Transmission par courroie.
- 2 systèmes de sécurité : une vis de blocage du couvercle et un capteur électromagnétique (l'appareil s'arrête lors de l'ouverture du couvercle).
- 4 pieds en caoutchouc pour une meilleure stabilité.

EN

- Vegetable slicer for professional use.
- Manufactured entirely in high strength anodized aluminium.
- Removable upper body for easy cleaning, maintenance, and placement of slicing discs.
- 2 openings for different types of vegetables; semicircular opening with lever for larger foods (potatoes, tomatoes, onions, etc.) and round opening with pusher for smaller vegetables (cucumbers, zucchini, carrots, etc.).
- Includes 5 blades: two slicing discs (2 and 4 mm) and three grating discs (3, 5 and 7 mm).
- Continuous operation Belt drive.
- 2 safety systems: cover locking screw and an electromagnetic sensor (when the cover is opened the machine turns off).
- 4 rubber bases for improved stability.



2 entradas para los diferentes tipos de verduras
2 openings for different types of vegetables

Producción
100-300 kg/h
Production



Cortadora de vegetales PROFESIONAL

Coupe-légumes - Gemüseschneider
Vegetable slicer - Cortadora de verduras

Ref	€	W	U.Venta
69500	1386,30	550	1

Ref	Tensión/Voltage	Potencia/Power	Nºdiscos/Discs	Veloc. discos Discs speed	Orif. redondo Round hole size	Orif. semicircular Semicircular hole	Dimensiones/Sizes	Peso/Weight
69500	220-240 V ; 50 Hz	550 W	5	270 r.p.m.	Ø 6 cm	17x7,5 cm	57x23x51 cm	22,5 Kg

Accesorios · Accessoires · Accessories



Disco rallador

Disque à râper · Reibe Scheibe
Grater disc · Disco de ralador

	Ref	€	mm	U.Venta
A	69503	46,20	3	1
B	69505	46,20	5	1
C	69507	46,20	7	1

Disco cortador

Disque de coupe · Schneidscheibe
Cutter disc · Disco de corte

	Ref	€	mm	U.Venta
A	69512	46,20	2	1
B	69514	46,20	4	1

Discos opcionales (NO incluidos) · Disques en option (NON inclus) · Optional diss (NOT included)

Disco cortador

Disque de coupe · Schneidscheibe
Cutter disc · Disco de corte

	Ref	€	mm	U.Venta
A	69518	92,20	8	1
B	69510	92,20	10	1
C	69504	107,10	10	1
D	69506	125,30	10x10	1



KEBAB

Cortador

Professional use



Incluye dos cuchillas LISA y DENTADA y destornillador para desmontar la cuchilla y una práctica piedra afiladora
Includes two blades SMOOTH and SERRATED and screwdriver for removing the blade and a practical sharpening stone included



Cortador de kebab

Couteau à kebab · Kebab-Schneider
Kebab cutter · Cortador de kebab

Ref	€	W	U.Venta
69230	194,80	80	1

Ref	Tensión/Voltage	Potencia/Power	Velocidad/Speed	Cuchilla/Blade	Esp. corte/Thickness	Dimensiones/Sizes	Peso/Weight
69230	220-240 V; 50/60 Hz	80 W	2.800 r.p.m.	Ø100 mm	0 - 8 mm	19,9x11,4x18,4 cm	1,20 Kg

- Potente, silencioso e higiénico.
- Cuchilla desmontable de acero inoxidable de gran calidad.
- Corta sin esfuerzo y con una gran precisión.
- Regulador del grosor de corte (Ajustable de 0 a 8 mm).
- Mango ergonómico, se adapta perfectamente a la mano.
- Incluye un destornillador para desmontar la cuchilla y una práctica piedra afiladora.

- Puissant, silencieux et hygiénique.
- Lame démontable en acier inoxydable de grande qualité.
- Coupe sans efforts et avec une grande précision.
- Régulateur de l'épaisseur de découpe (réglable de 0 à 8 mm).
- Manche ergonomique, qui s'adapte parfaitement à la main.
- Inclut un tournevis pour démonter la lame et une pratique pierre à aiguiser.

- Powerful, quiet and clean.
- High quality stainless steel removable blade.
- Effortless and high precision cutting.
- Adjustable slicing thickness (from 0 to 8 mm).
- Ergonomic handle fits your hand perfectly.
- Screwdriver for removing the blade and a practical sharpening stone included.

Regulador del grosor de corte (ajustable de 0 a 8 mm)
Adjustable slicing thickness (from 0 to 8 mm)

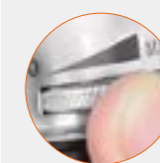

ALIMENTOS

Procesador

· Household use ·



ES

- Múltiples funciones; pica, ralla, mezcla, bate, monta y tritura.
- Rendimiento óptimo y profesional: resultados rápidos, homogéneos e inmejorables.
- Gran capacidad; recipiente transparente graduado y jarra batidora transparentegrada.
- Infinidad de posibilidades: gracias a sus accesorios de alto rendimiento podrás cocinar sin esfuerzo.
- Tapa y bol con sistema de anclaje de seguridad.
- Diseño atractivo, compacto y muy cómodo para guardar: los accesorios pueden guardarse en el mismo recipiente.
- Fácil de limpiar. Accesorios aptos para el lavavajillas.

FR

- Multifonctions : hache, râpe, malaxe, bat, fouette et triture.
- Des performances optimales et professionnelles : résultats rapides, homogènes et imbattables.
- Une grande capacité : récipient transparent gradué et bol mixeur transparent gradué.
- Des possibilités infinies : grâce à accessoires performants, vous pourrez cuisiner sans effort tout ce que vous voulez.
- Couvercle et bol avec système d'ancrage de sécurité.
- Design attrayant, compact et très pratique à ranger : les accessoires peuvent être stockés dans le même récipient.
- Facile à nettoyer. Accessoires lavables au lave-vaisselle.

EN

- Multiple functions: It minces, grates, mixes, blends, whips and grinds.
- Optimum and professional performance: fast, homogeneous and unbeatable results.
- High capacity: graduated transparent container and a graduated transparent blender pitcher.
- Limitless possibilities: thanks to high performance accessories you can cook anything you wish effortlessly.
- The lid and bowl have a safety latch system.
- The attractive, compact and very comfortable design lets you keep the accessories right in the container.
- Easy to clean: the accessories are dishwasher safe.



Corte con cuchilla
Cutting with blades

Exprimidor
Citrus press

Conjunto Cuchillas
Mezclador-amasa-
dor Batidor
Set Blades
Mixer-kneader · Whisk

Jarra batidora
Blender jug

Procesador de alimentos multiGenius

Robot multifonction · Küchenmaschine
Food processor · Processador de alimentos

Ref	€	W	U.Venta
69579	132,00	800	1

Ref	Tensión/Voltage	Potencia/Power	Velocidades/Speeds	Capacidad/Capacity	Dimensiones jarra Jar sizes	Dimensiones jarra bat. Blender jar sizes	Peso jarra Jar weight	Peso jarra bat. Blender jar weight	Peso Weight
69579	220-240 V; 50/60 Hz	800 W	2 + PULSE	2,0 L - Jarra 1,5 L - Batidor 30 ml - Vaso medidor	26x24x42,5 cm	23x24x43,5 cm	2,70 Kg	2,47 Kg	3,80 Kg



8
Accesorios
Accessories



Jarra batidora
Blender jug

Conjunto
batidor/montador
Blending/whipping
unit

Molinillo + Tapa
Grinder + Lid

Discos corte
Cutting discs

Conj. exprimidor
Juicer attachment

Cortador mini
Mini cutter

Conj. licuadora
Smoothie unit

Corte con cuchilla
Cutting with blades



8
Funciones
Functions

Robot multifunción

Robot multifonctions · Multifunktions-Roboter
Multifunction robot · Robò multifuncionais

Ref	€	W	U.Venta
69079	184,30	800	1

Ref	Tensión/Voltage	Potencia/Power	Velocidades/Speeds	Capacidad/Capacity	Dimensiones/Sizes	Peso/Weight
69079	220-240 V; 50 Hz	800 W	10	1,50 L	24x22x40 cm	6,50 Kg



2 en 1

Accesorio para helado de frutas
Fruit ice cream accessory

5 cuchillas de colores
5 colored blades



Corta vegetales + máquina de helado COSMO

Hachoir légumes + machine à fruitcreme glacee · Gemüseschneider + Obst-Eis machine
Vegetables cutter + ice fruit machine · Corta vegetables + máq. de gelado de fruta

Ref	€	W	U.Venta
69115	80,30	150	1

Ref	Tensión/Voltage	Potencia/Power	Cuchillas/Blades	Dimensiones/Sizes	Peso/Weight
69115	220-240 V; 50/60 Hz	150 W	6	24,5x22,5x19,5 cm	1,89 Kg



- Versátil: Procesador eléctrico de verduras con accesorio para hacer helado.
- Incluye 6 cuchillas de corte (en formato cono) de acero inoxidable de máxima calidad para todo tipo de cortes; verdura, fruta, queso, frutos secos, chocolate, etc.
- Incluye un accesorio diseñado para hacer helados y sorbetes con fruta congelada.
- Rápido, intuitivo y muy fácil de usar.
- Compacto: Práctico para usar y guardar; las cuchillas se almacenan en el interior.
- 100% seguro: no hay contacto directo con las manos.
- Funcionamiento silencioso.
- Fácil de limpiar: accesorios aptos para el lavavajillas.
- 100% Libre de BPA.

- Fully versatile: electric vegetable cutter with an ice cream attachment.
- Includes 6 top quality stainless steel, cone-type cutting blades for all kinds of cuts; suitable for vegetables, fruit, cheese, nuts, chocolate, etc.
- Comes with an attachment to make ice cream and sorbets from frozen fruit.
- Very practical, quick and easy to use.
- Compact: convenient to use and store; blades neatly stored inside.
- 100% safe: no direct contact with hands.
- Silent operation.
- Easy to clean: dishwasher safe accessories.
- 100% BPA free

Click here



DESHIDRATADORES

Colección



ES

- Una forma natural y sencilla de conservar frutas, verduras, setas, carnes, pescados, etc. con todos sus nutrientes durante más tiempo.
- Extrae el agua, impidiendo su descomposición por microorganismos, conservándolos sin perder sus valores.
- Calentamiento, el aire circula por su interior de manera uniforme, penetrando por los orificios de las bandejas.
- Accesorio adicional para deshidratar salsas y realizar galletas.

FR

- Une façon naturelle et simple de conserver les fruits, les légumes, les champignons, les viandes, les poissons, etc. en gardant tous leurs nutriments pendant plus longtemps.
- Extrait l'eau, empêchant ainsi leur décomposition due à des microorganismes, en les conservant sans perdre leurs valeurs.
- Chauffe, l'air circule uniformément, en pénétrant par les orifices des plateaux.
- Accessoire supplémentaire pour déshydrater des sauces et réaliser des biscuits.

EN

- A natural and easy way to preserve fruits, vegetables, mushrooms, meats, fish, etc. with all their nutrients for more time.
- Extracts water from foods, preventing spoilage due to microorganisms and preserving them without losing their values.
- Heating, the air circulates evenly through its interior, penetrating through the holes in the trays.
- Additional accessory for dehydrating sauces and making biscuits.



6
Bandejas
Trays

Deshidratador de alimentos PRO

Deshydrateur des aliments · Obstrockner, elektrisch
Food dehydrator · Desidratador de alimentos

Ref	€	W	U.Venta
69523	203,90	800	1

Ref	Tensión/Voltage	Potencia/Power	Temperatura/Temp.	Capacidad/Capacity	Dimensiones/Sizes	Peso/Weight
69523	220-240 V; 50/60 Hz	800 W	29°C - 73°C (máx)	6 bandejas / Trays	36x47x26 cm	5,50 Kg

Accesorio · Accessoire · Accessory

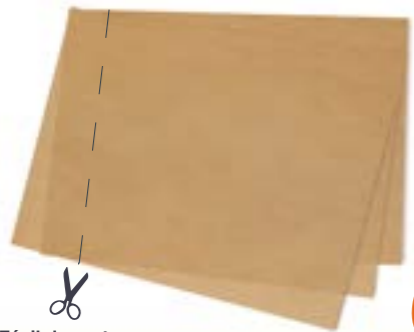

Fácil de cortar
Easy to cut

3
pcs

Apto para todas las freidoras de aire · Suitable for all air fryers

Láminas antiadherentes

Feuilles antiadhésif · Antihaf-Bblätter
Non-stick sheets · Láminas antiaderentes

Ref	€	cm	unidades	U.Venta
66746	9,80	30x40	3	1



- Láminas de fibra de vidrio con recubrimiento antiadherente de gran calidad.
- Ideal para colocar sobre bandejas o parrillas de hornos y deshidratadores.
- Vida útil aproximadamente de 1000 horneados.
- Diseñadas para soportar temperaturas de hasta 250°C.
- Recortable para adaptar a cualquier recipiente.
- Reutilizables, para una correcta conservación se recomienda su lavado a mano.
- No aptas para el lavavajillas.

- Fibreglass sheets with non-stick coating high-quality.
- Ideal for placing on baking trays, oven racks and dehydrators.
- Can be used approximately 1,000 times.
- Designed to withstand temperatures up to 250°C.
- Can be cut to fit any container.
- Reusable; in order to keep the sheets in good condition, we recommend washing by hand.
- Non-dishwasher safe.

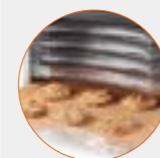

· Semiprofessional use ·



5
Bandejas
Trays
Tiempo recomendado
48 h (max)
Recommended time



Deshidratador giratorio TERRA

Déshydrateur tournant · Drehdehydrator
Rotating dehydrator · Desidratador giratório

Ref	€	W	U.Venta
69223	129,50	500	1

· Household use ·



5
Bandejas
Trays
Tiempo recomendado
35 h (max)
Recommended time



Deshidratador de alimentos WHITE

Deshydrateur des aliments · Obstrockner, elektrisch
Food dehydrator · Desidratador de alimentos

Ref	€	W	U.Venta
69123	76,30	250	1

Ref	Tensión/Voltage	Potencia/Power	Temperatura/Temp.	Capacidad/Capacity	Dimensiones/Sizes	Peso/Weight
69223	220-240 V; 50/60 Hz	500 W	70°C (max)	5 bandejas / Trays	Ø33x22 cm	2,80 Kg
69123	220-240 V; 50/60 Hz	250 W	70°C (max)	5 bandejas / Trays (13,5 L)	Ø32x27 cm	2,45 Kg

ECCO

Cocedor de vapor



Numeración en bandejas
Cubeta para cocinar arroz
Numbering in trays
Container for cooking rice

Mantiene todos los
nutrientes, aromas y
sabores de los alimentos
Retains all the nutrients,
aromas and flavours of food

Cocedor al vapor ECCO

Cuiseur vapeur · Dampfkochgerät
Steam cooker · Panela de cocção a vapor

Ref	€	W	U.Venta
69121	92,00	1000	1

Ref	Tensión/Voltage	Potencia/Power	Temperatura/Temp.	Capacidad/Capacity	Dimensiones/Sizes	Peso/Weight
69121	220-240 V; 50-60 Hz	1000 W	100°C (máx)	12 L	41x35x26,57 cm	3,16 Kg



INDUCCIÓN

Freidora

Professional use

Inox CE

ES

- Ideal para un uso intensivo en la hostelería y cocinas con grandes cargas de trabajo.
- Potente y eficiente. Capacidad de 8 L.
- Construida totalmente en acero inoxidable (exterior e interior) que garantiza durabilidad y resistencia.
- Gracias al sistema de calentamiento por inducción se consigue una temperatura estable en todo el área, disminuyendo el impacto térmico en el momento de introducir los alimentos.
- Control de temperatura variable de 60°C a 190°C.
- Protección contra el sobrecalentamiento.
- Equipada con grifo de vaciado y elemento de calentamiento oculto para facilitar la limpieza.
- Tapa y cesta incluidas.

FR

- Idéale pour un usage intensif dans l'hôtellerie et dans des cuisines avec de grandes charges de travail.
- Puissante et efficace. Capacité de 8 L.
- Entièrement fabriquée en acier inoxydable (extérieur et intérieur), ce qui garantit durabilité et résistance.
- Le système de chauffe par induction permet d'obtenir une température stable dans tout l'espace, réduisant ainsi l'impact thermique lors de l'introduction des aliments.
- Contrôle de température variable de 60°C à 190°C.
- Protection contre la surchauffe.
- Équipée d'un robinet de vidange et d'un élément de chauffe caché pour faciliter le nettoyage.
- Couvercle et panier inclus.

EN

- Perfect for heavy use in hotels and restaurants and kitchens with big work loads.
- Powerful and efficient 8 L Capacity.
- Made entirely of stainless steel (inside and outside), which guarantees strength and durability.
- Because of the induction heating system there is a stable temperature in the whole area, which reduces thermal impact when putting the food inside.
- Variable temperature control from 60°C to 190°C.
- Protection against overheating.
- It has a drain tap and a hidden heating element for easy cleaning.
- Lid and basket included.

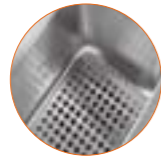

Rejilla
Rack



Cerrado
Closed



Abierto
Open



Freidora de inducción

Friteuse à induction · Induktionsfriteuse
Induction fryer · Fritadeira de indução

Ref	€	W	L	U.Venta
69465	537,40	3500	8	1

Ref	Tensión/Voltage	Potencia Power	Rango temperatura Temperature range	Cestillo Basket	Cap. cestillo Basket cap.	Tanque aceite oil tank	Cap. tanque aceite Oil tank capacity	Dimensiones Sizes	Peso Weight
69465	220-240 V; 50 Hz	3500 W	60°C - 190°C	19x23x14,5 cm	5,5 L	23,8x30x20,5 cm	8 L	29x56,7x41,5 cm	12,6 Kg

PROFESIONAL

Freidora

Inox CE

ES

- Destinada a un uso intensivo en restaurantes, bares, hoteles, etc.
- Especial para todo tipo de frituras, permite freír gran cantidad de alimento.
- Fabricada en acero inoxidable, exterior e interior, garantiza una gran durabilidad y resistencia.
- Termostato de temperatura regulable.
- Termostato de seguridad con rearme manual.
- Mango termorresistente.
- Sistema de fijación de la cesta para escurrir el aceite.
- Indicador máximo-mínimo de nivel de aceite.
- Panel extraíble para facilitar el mantenimiento y la limpieza.

FR

- Destinée à un usage intensif dans les restaurants, les bars, les hôtels, etc.
- Spécial pour tout type de friture, permet de frire de grandes quantités d'aliments.
- Fabriquée en acier inoxydable, extérieur et intérieur, elle garantit une grande durabilité et résistance.
- Thermostat de température réglable.
- Thermostat de sécurité avec réinitialisation manuelle.
- Manche résistant à chaleur.
- Système de fixation du panier pour égoutter l'huile.
- Indicateur maximum-minimum du niveau d'huile.
- Panneau extractible pour faciliter l'entretien et le nettoyage.

EN

- Intended for heavy-duty use in restaurants, bars, hotels, etc.
- Essential for all types of fried dishes, it can fry a large amount of food.
- Made of stainless steel, exterior and interior, guarantees great durability and resistance.
- Adjustable temperature thermostat.
- Safety thermostat with manual reset.
- Heat resistant handle.
- System for hanging the basket to drain the oil.
- Minimum-maximum oil level indicator.
- Removable panel for easy maintenance and cleaning.



Resistencia
Resistance



Cerrado
Closed

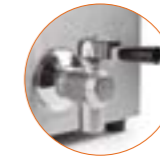

Abierto
Open



Freidora

Friteuse · Friteuse
Fryer · Fritadeira

Ref	€	W	L	U.Venta	
69169	272,40	2500	6,0	1	Simple · Simple
69466	426,30	2500x2	6,0x2	1	Doble · Double

Freidora con grifo

Friteuse avec robinet · Friteuse mit Wasserhahn
Fryer with tap · Fritadeira com torneira

Ref	€	W	L	U.Venta	
69468	288,90	3250	8,0	1	Simple · Simple
69469	550,80	3250x2	8,0x2	1	Doble · Double

Ref	Tensión/Voltage	Potencia/Power	Temperat./Temp.	Capac./Capacity	Cont./Container	Cestillo/Basket	Dimensiones/Sizes	Peso/Weight
69169	220-240 V; 50/60 Hz	2500 W	50°C - 190°C	6,0 L	32,5 x26,5x15 cm	24x20x10,5 cm	27x41x31 cm	5,50 Kg
69466	220-240 V; 50/60 Hz	2500 W x 2	50°C - 190°C	6,0 L x 2	32,5 x26,5x15 cm	24x20x10,5 cm	55x41x31 cm	10,0 Kg
69468	220-240 V; 50/60 Hz	3250 W	50°C - 190°C	8,0 L	24x30x20 cm	18,5x24x14 cm	27x41x42 cm	7,00 Kg
69469	220-240 V; 50/60 Hz	3250 W x 2	50°C - 190°C	8,0 L x 2	24x30x20 cm	18,5x24x14 cm	55x41x42 cm	14,0 Kg

ERGO

Freidora

· Semiprofessional use ·



ES

- Especial para todo tipo de frituras, permite freír gran cantidad de alimentos.
- Termostato de temperatura regulable.
- Termostato de seguridad con rearme manual.
- Mango termorresistente.
- Sistema de fijación de la cesta para escurrir el aceite.
- Indicador máximo-mínimo de nivel de aceite.
- Las paredes exteriores se mantendrán frías en todo momento.

FR

- Spécial pour tout type de friture, permet de frire de grandes quantités d'aliments.
- Thermostat de température réglable.
- Thermostat de sécurité avec réinitialisation manuelle.
- Manche résistant à chaleur.
- Système de fixation du panier pour égoutter l'huile.
- Indicateur maximum-minimum du niveau d'huile.
- Les parois extérieures restent toujours froides.

EN

- Essential for all types of fried dishes, it can fry a large amount of food.
- Adjustable temperature thermostat.
- Safety thermostat with manual reset.
- Heat resistant handle.
- System for hanging the basket to drain the oil.
- Minimum-maximum oil level indicator.
- The external walls will be kept cool at all times.

Fabricada en acero inoxidable, garantiza una gran durabilidad y resistencia
Made of stainless steel, guarantees great durability and resistance



Ventana en la tapa
Cubeta extraíble
Cabezal desmontable
Window in the lid
Removable tray
Detachable head



Freidora

Friteusem · Friteuse
Fryer · Fritadeira

Ref	€	W	L	U.Venta
69135	113,20	2000	3,50	1 Simple · Simple
69170	226,80	2000x2	3,50x2	1 Doble · Double

Freidora con grifo

Friteuse avec robinet · Friteuse mit Abflabahn
Fryer with tap · Fritadeira com torneira

Ref	€	W	L	U.Venta
69134	196,00	2500	4,0	1

Ref	Tensión/Voltage	Potencia/Power	Temperatura/Temp.	Capacidad/Capacity	Dimensiones/Sizes	Peso/Weight
69135	220-240 V; 50/60 Hz	2000 W	190°C	3,50 L	41x22x21 cm	2,70 Kg
69170	220-240 V; 50/60 Hz	4000 W	190°C	3,50 x 2 L	41x39,5x21 cm	6,60 Kg
69134	220-240 V; 50/60 Hz	2500 W	190°C	4,00 L	44,3x24,7x27,5 cm	2,94 Kg

dAirePro

Freidora de aire

· Household use ·



ES

- **RapidAir Technology: la tecnología de ventilación de aire caliente circula a máxima velocidad y a 360° dentro de la cámara de cocción.**
- **Máxima versatilidad "9 en 1"**
- **Control de tiempo (hasta 60 minutos y 6 horas para deshidratar) y ajuste de temperatura de cocción de forma precisa (de 40°C a 200°C).**
- **Gran potencia 1700W y máxima capacidad: 12 litros.**
- **7 accesorios incluidos: 3 rejillas, bandeja, cestillo redondo, pincho mariposa y asa para cestillo redondo.**

FR

- **RapidAir Technology: La technologie de ventilation à air chaud circule à une vitesse maximum et à 360° dans la chambre de cuisson.**
- **Versatilité maximum « 9 en 1 »**
- **Contrôle de temps (jusqu'à 60 minutes et 6 heures pour déshydrater) et réglage de la température de cuisson de façon précise (de 40°C à 200°C).**
- **Grande puissance de 1700W et capacité maximale de 12 litres.**
- **7 accessoires inclus: 3 grilles, plateau, panier rond, tournebroche et poignée pour panier rond.**

EN

- **RapidAir Technology: the air ventilation technology circulates hot 360°C air at maximum speed inside the cooking chamber**
- **Maximum "9-in-1" versatility**
- **Time control (up to 60 minutes and 6 hours for dehydration) and precise cooking temperature settings (from 40°C to 200°C).**
- **High power: 1700W. Maximum capacity: 12 litres.**
- **7 accessories included: 3 racks, tray, round basket, skewer with clamps and handle for round basket.**

Freidora de aire dAirePro

Friteuse airfryer · Aidfryer Heißluft-Fritteuse
Air fryer · Fritadeira de aire

Ref	€	W	L	U.Venta
69513	187,50	1700	12	1



7 accesorios incluidos
7 accessories included:

Ref	Tensión/Voltage	Potencia Power	Temp. Temp.	Temporizador Timer	Programas Programmes	Capacidad Capacity	Medidas internas Internes sizes	Dimensiones Sizes	Peso Weight
69513	220-240 V; 50/60 Hz	1700 W	40°C - 200°C	1 - 60 min	9	12 L	25x22x17,5 cm	32,3x35,8x37,8 cm	8,50 Kg

DUPLOAIR

Freidora de aire

Household use



ES

- 11 programas automáticos preestablecidos
- **Gran capacidad: 9 L (dos cestillos extraíbles de 4,0 L de capacidad cada uno).**
- **Cestillo doble: control de tiempo y temperatura independiente.**
- **SyncFinish: acabado sincronizado.**
- **Temperatura regulable: gracias a su termostato podrás regular la temperatura desde 45°C a 200°C. Tiempo ajustable: 0-60 minutos (función deshidratada hasta 20 horas).**
- **Potencia: 2400 W.**

FR

- 11 programmes automatiques préétablis.
- Grande capacité : 9L (Deux paniers amovibles d'une capacité de 4,0 L chacun).
- Panier double : contrôle du temps et de la température de façon indépendante.
- SyncFinish : fin synchronisée.
- Température réglable : Grâce à son thermostat, la température peut être réglée de 45°C à 200°C.
- Durée réglable de 0 à 60 minutes (fonction déshydratation jusqu'à 20 heures).
- Puissance : 2400 W.

EN

- 11 pre-set automatic programmes.
- High capacity: 9 L (two removable 4.0 L capacity baskets each).
- Double basket: independent time and temperature control.
- SyncFinish: synchronised finish.
- Adjustable temperature: the thermostat allows you to set the temperature from 45°C to 200°C.
- Programmable time: 0-60 minutes (dehydration function up to 20 hours).
- Power: 2400 W.

Tecnología TotalCook: distribuye el calor de manera uniforme a través del aire caliente a gran velocidad

TotalCook Technology: it distributes heat uniformly with high speed hot air.

Incluye rejillas
Includes grids

Freidora de aire DUPLOAIR

Friteuse airfryer · Aidfryer Heißluft-Fritteuse
Air fryer · Fritedeira de aire

Ref	€	W	U.Venta
69508	212,60	2400	1

Ref	Tensión/Voltage	Potencia Power	Temp. Temp.	Temporizador Timer	Programas Programs	Capacidad cestillo Basket capacity	Medidas cestillo Basket sizes	Dimensiones Sizes	Peso Weight
69508	220-240 V; 50/60 Hz	2400 W	45°C - 200°C	1 - 60 min	11	4,0 L (x2)	14,5x21x12,5 cm	41x33,5x31,5 cm	7,50 Kg

CrystalFry

Freidora de aire



ES

- 8 programas automáticos preestablecidos
- **Tecnología TotalCook: distribuye el calor de manera uniforme a través del aire caliente a gran velocidad.**
- **Gran capacidad: 7,0 litros.**
- **Intuitiva y muy fácil de usar: gracias a la pantalla digital se puede ajustar el tiempo (hasta 60 minutos), la temperatura (de 40°C a 200°C.) y los 8 programas preestablecidos.**
- **TotalControl: controla el cocinado gracias a la puerta de cristal y la luz interior.**
- **Cestillo extraíble con antiadherente 100% libre de PFOA. Libre de BPA.**

FR

- 8 programmes automatiques préétablis.
- Technologie TotalCook : distribue la chaleur de manière homogène à travers l'air chaud à grande vitesse.
- Grande capacité : 7,0 litres.
- Intuitif et très facile à utiliser : grâce à l'affichage numérique, vous pouvez régler le temps (jusqu'à 60 minutes), la température (de 40°C à 200°C) et les 8 programmes prédéfinis.
- TotalControl : contrôle le processus de cuisson grâce à la porte en verre et à l'éclairage intérieur.
- Panier amovible avec revêtement antiadhésif sans PFOA. Sans BPA.

EN

- It has 8 pre-set automatic programmes
- TotalCook Technology: It distributes heat uniformly with high speed hot air.
- High capacity: 7,0 litres.
- Intuitive and very easy to use: Thanks to the digital screen, you can set the time (up to 60 minutes), temperature (from 40°C to 200°C) and use 8 pre-set programmes.
- TotalControl: controls the cooking process thanks to glass door and interior light.
- The removable non-stick basket is 100% PFOA free. BPA free.

Tecnología TotalCook: distribuye el calor de manera uniforme a través del aire caliente a gran velocidad

TotalCook Technology: it distributes heat uniformly with high speed hot air.

TotalControl: controla el cocinado gracias a la puerta de cristal y la luz interior

TotalControl: control the cooking process thanks to glass door and interior light

Incluye rejillas
Includes grids

Freidora de aire CrystalFry

Friteuse airfryer · Aidfryer Heißluft-Fritteuse
Air fryer · Fritedeira de aire

Ref	€	W	L	U.Venta
69515	126,90	1700	7,0	1

Ref	Tensión/Voltage	Potencia Power	Temp. Temp.	Temporizador Timer	Capacidad cubeta Container capacity	Medidas cestillo Basket sizes	Dimensiones Sizes	Peso Weight
69515	220-240 V; 50/60 Hz	1700 W	40°C - 200°C	1 - 60 min	7,0 L	28x24x13 cm	40,9x29,6x34,2 cm	5,07 Kg

ECOFRY

Freidora de aire



ES

- 8 programas automáticos preestablecidos
- **Tecnología TotalCook: distribuye el calor de manera uniforme a través del aire caliente a gran velocidad.**
- **Gran capacidad: 5,5 litros (cestillo).**
- **Intuitiva y muy fácil de usar: gracias a la pantalla digital se puede ajustar el tiempo (hasta 60 minutos), la temperatura (de 40°C a 200°C.) y los 8 programas preestablecidos.**
- **Recipiente/Cestillo extraíble con antiadherente 100% libre de PFOA.**

FR

- 8 programmes automatiques pré-régulés
- Technologie TotalCook : distribue la chaleur de manière homogène à travers l'air chaud à grande vitesse.
- Grande capacité : 5,5 litres (panier).
- Intuitif et très facile à utiliser : grâce à l'affichage numérique, vous pouvez régler le temps (jusqu'à 60 minutes), la température (de 40°C à 200°C) et les 8 programmes prédéfinis.
- Récipient/panier amovible avec revêtement antiadhésif sans PFOA.

EN

- It has 8 pre-set automatic programmes
- TotalCook Technology: it distributes heat uniformly with high speed hot air.
- High capacity: 5.5 litres (basket).
- Intuitive and very easy to use: thanks to the digital screen, you can set the time (up to 60 minutes), temperature (from 40°C to 200°C) and use 8 pre-set programmes.
- The removable non-stick basket/container is 100% PFOA free.



Tecnología TotalCook: distribuye el calor de manera uniforme a través del aire caliente a gran velocidad
TotalCook Technology: it distributes heat uniformly with high speed hot air.

Incluye rejillas
Includes grids



Freidora de aire ECOFRY
Friteuse airfryer · Aidfryer Heißluft-Fritteuse
Air fryer · Friteadeira de aire

Ref	€	W	U.Venta
69511	171,00	1700	1

Ref	Tensión/Voltage	Potencia Power	Temp. Temp.	Temporizador Timer	Programas Programmes	Cap./medidas cestillo Basket cap./Sizes	Cap./Medidas cubeta Container cap./Sizes	Dimensiones Sizes	Peso Weight
69511	220-240 V; 50/60 Hz	1700 W	40°C - 200°C	1 - 60 min	8	5,5 L (24x21,5x11,5 cm)	6,5 L (26x23,8x13 cm)	41x30x34,5 cm	5,40 Kg

VITALCOOK

Freidora de aire



ES

- **Tecnología TotalCook: distribuye el calor de manera uniforme a través del aire caliente a gran velocidad.**
- **Capacidad: 3,0 litros.**
- **Intuitiva y muy fácil de usar: gracias a la pantalla digital se puede ajustar el tiempo (hasta 60 minutos) y la temperatura (de 40°C a 200°C).**
- **Recipiente extraíble con antiadherente 100% libre de PFOA. Libre de BPA.**
- **Fácil limpieza.**

FR

- Technologie TotalCook : distribue la chaleur de manière homogène à travers l'air chaud à grande vitesse.
- Capacité : 3,0 litres.
- Intuitif et très facile à utiliser : grâce à l'affichage numérique, vous pouvez régler le temps (de 1 à 60 minutes) et la température (de 40°C à 200°C).
- Récipient amovible avec revêtement antiadhésif sans PFOA. Sans BPA.
- Facile à nettoyer.

EN

- TotalCook Technology: It distributes heat uniformly with high speed hot air.
- Capacity: 3.0 litres.
- Intuitive and very easy to use: thanks to the digital screen, you can set the time (up to 60 minutes) and temperature (from 40°C to 200°C).
- The removable non-stick container is 100% PFOA free. BPA free.
- Easy to clean.



Tecnología TotalCook: distribuye el calor de manera uniforme a través del aire caliente a gran velocidad
TotalCook Technology: it distributes heat uniformly with high speed hot air.

Incluye rejilla
Grid included

Freidora de aire VITALCOOK
Friteuse airfryer · Aidfryer Heißluft-Fritteuse
Air fryer · Friteadeira de aire

Ref	€	W	U.Venta
69509	107,60	1000	1

Ref	Tensión/Voltage	Potencia Power	Temp. Temp.	Temporizador Timer	Capacidad cubeta Container capacity	Medidas cubeta Container sizes	Dimensiones Sizes	Peso Weight
69509	220-240 V; 50/60 Hz	1000 W	40°C - 200°C	1 - 60 min	3,0 L	Ø19x9 cm	34x25x33 cm	2,97 Kg

SOBREMESA

Hornos

· Semiprofessional use ·



ES

- Hornos eléctricos de sobremesa de convección con carcasa de acero en acabado negro.
- Capacidad de 28/35 litros y potencia máxima de 1650/1850 W.
- Alto rendimiento en un diseño compacto.
- Manejables y funcionales.
- 5 funciones predefinidas y temporizador de 0-120 minutos con señal sonora.
- Temperatura ajustable máx. de 230°C.
- Transfieren el calor a través de 4 resistencias.
- Pared de aislamiento y puerta abatible de doble cristal de alta resistencia.
- Luz interior que permite vigilar el proceso.
- Revestimiento antiadherente interior para una fácil limpieza. 100% libre de PFOA.
- Incluyen: bandeja para hornear, parrilla, pinza para bandeja, rustidor giratorio, mango para el rustidor y bandeja recogemigas.

FR

- Four électrique à convection à poser avec corps en acier en use finition noire.
- Capacité de 28/35 litres et puissance maximale de 1650/1850W.
- Haut rendement dans un design compact.
- Maniable et fonctionnel.
- 5 fonctions prédéfinies et minuteur de 0 à 120 minutes avec signal sonore.
- Température réglable : max. 230°C
- Transfère la chaleur à travers 4 résistances.
- Paroi isolante et porte rabattable à double vitrage hautement résistante.
- Éclairage intérieur qui permet de contrôler la cuisson.
- Revêtement antiadhésif intérieur pour un nettoyage facile. 100% sans PFOA.
- Inclut un plat lèche-frites, une grille, une pince pour le plat lèche-frites, une broche à rôtir tournante, un manche pour la broche et une plaque de four.

EN

- Electric countertop convection oven with black finish steel use body.
- 28 L/35 L capacity · 1650 W/1850 W max. power.
- High performance in a compact design.
- Highly practical and functional.
- 5 pre-set functions and 0-120 min. timer with audible beep.
- 230°C max. adjustable temperature.
- Transfers heat through 4 heating elements.
- Insulated walls and high-strength, Transfers heat through 4 heating elements.
- Inside light to monitor progress as food cooks.
- Non-stick coating inside for easy cleaning. 100% BPA free.
- Includes baking tray, grill rack, tray tongs, rotating rotisserie spit, spit handle and crumb tray.

Accesorios · Accessoires · Accessories

Antiadherente interior
Non-stick interior

Transfiere el calor a través de 4 resistencias
Transfers heat through 4 heating elements

Puerta abatible de doble cristal
Double glass hinged door

Bandeja recogemigas
Crumb tray

Rustidor giratorio
Rotating rotisserie spit

Parrilla
Grate

Bandeja de horno
Oven tray

Pinza para bandeja
Try tong

Mango para rustidor
Spit handle



3
Bandejas
Trays



4
Bandejas
Trays

Horno sobremesa

Four à poser · Tischbackofen
Countertop oven · Forno de mesa

Ref	€	W	L	U.Venta
A 69327	217,90	1650	28	1
B 69347	244,70	1850	35	1

Ref	Tensión/Voltage	Potencia/Power	Capacidad/Capacity	Temporizador/Timer	Temp.	D. int/Int. size	Dimensiones/Sizes	Peso/Weight
69327	220-240 V; 50 Hz	1650 W	28 L	0 - 120 min	70°C - 230°C	34,5x28x20 cm	48x30x40 cm	8,20 Kg
69347	220-240 V; 50 Hz	1850 W	28 L	0 - 120 min	70°C - 230°C	36,5x28,5x23 cm	54x34,5x41 cm	9,75 Kg



Funciones: asar, cocer, hervir, freír, gratinar, tostar y descongelar
2 mandos: temporizador y nivel de temperatura
Capacidad: 12 L con la posibilidad de 5 L adicionales
Reduce el nivel de grasa de los alimentos
Functions: roast, cook, boil, fry, gratin, toast and defrost
2 controls, timer and temperature level
Capacity: 12 L with the possibility of an additional 5 L
Reduce the fat levels in processed food



Mecanismo de ciclo de aire caliente
Hot air cycle mechanism



Horno halógeno convección GLASS

Four à convection halogène · Obsttrockner, Elektrisch
Convection halogen glass oven · Forno de vidrio

Ref	€	W	U.Venta
69312	94,80	1400	1

Ref	Tensión/Voltage	Potencia/Power	Temperatura/Temp.	Capacidad/Capacity	Temporiz./Timer	Dimensiones/Sizes	Peso/Weight
69312	220-240 V; 50/60 Hz	1400 W	125 - 250°C	12,0 L	0 - 60 min.	41x33x31 cm	6,10 Kg

MICROONDAS

Colección

· Professional use ·



Horno microondas PROFESIONAL

Four à micro ondes professionnel · Mikrowelle Professional
Professional microwave oven · Microondas profesional

Ref	€	W	L	U.Venta
69325	628,40	1000	25	1

Ref	Tensión/Voltage	Potencia/Power	Capacidad/Capacity	Dimensiones int./Int. sizes	Dimensiones/Sizes	Peso/Weight
69325	220-240 V / 50 Hz	1000 W	25 L	32x32x19 cm	51x43x31 cm	14,60 Kg

- Diseñado para uso intensivo, reduciendo el tiempo de calentamiento un 60%.
- Materiales robustos y mayores medidas de seguridad.
- Mayor protección del usuario a radiaciones.
- Base de cerámica plana, sin plato de vidrio.
- Posibilidad de calentar platos grandes.
- Cavidad interior de acero inoxidable (más higiénico).
- Calentamiento homogéneo.

- Conçu pour un usage intensif, réduisant le temps de chauffe de 60%.
- Matériaux robustes et mesures de sécurité accrues.
- Protection plus importante de l'utilisateur vis-à-vis des radiations.
- Base en céramique plate, sans plateau en verre.
- Possibilité de chauffer de grandes assiettes.
- Cavité intérieure en acier inoxydable (plus hygiénique).
- Chauffe homogène.

- Designed for intensive use; reduces heating time by 60%.
- Robust materials and greater safety measures.
- Greater protection against heat for the user.
- Flat ceramic base with no glass plate.
- It can heat large dishes.
- Inside cavity made of stainless steel (more hygienic).
- Even heating.

New

Professional use



Microondas TEMPO

Micro-ondes · Mikrowelle
Microwave · Microondas

Ref	€	W	L	U.Venta
69329	487,30	1550	25	1

- Diseñado para uso intensivo, reduciendo el tiempo de calentamiento un 60%.
- Regulador de tiempo mecánico, rápido e intuitivo. Evita pérdida de tiempo en la programación.
- Base de cerámica plana, sin plato de vidrio.
- Posibilidad de calentar platos grandes, fuentes y bandejas de otro formato.
- Cavity interior de acero inoxidable (más higiénico).
- Calentamiento homogéneo.

- Conçu pour un usage intensif, réduisant le temps de chauffe de 60%.
- Contrôleur de temps mécanique, rapide et intuitif. Evite de perdre du temps en programmation.
- Base en céramique plate, sans plateau en verre.
- Possibilité de chauffer de grandes assiettes, plates et plateaux d'autre format.
- Cavité intérieure en acier inoxydable (plus hygiénique).
- Chauffe homogène.

- Designed for intensive use; reduces heating time by 60%.
- Mechanical, fast and intuitive time controller. Avoids wasting time in programming.
- Flat ceramic base with no glass plate.
- It can heat large dishes, other format fonts and trays.
- Inside cavity made of stainless steel (more hygienic).
- Even heating.

Ref	Tensión/Voltage	Potencia/Power	P.salida/ output p.	Capacidad/Capacity	Dim. Interiores Interior sizes	Dimensiones/Sizes	Peso/Weight
69329	220-240 V; 50/60 Hz	1550 W	1000 W	25 L	32x32x19 cm	51x43x31 cm	14,7 Kg

Household use

Plato giratorio de Ø24,5 cm
Rotating plate Ø24.5 cm

Microondas WHITE

Micro-ondes · Mikrowelle
Microwave · Microondas

Ref	€	W	L	U.Venta
69322	157,90	700	20	1



Ref	Tensión/Voltage	Potencia/Power	Grill	Temporizador/Timer	Capacidad/Capacity	Plato/Plate	D. interiores/Sizes int.	Dimensiones/Sizes	Peso/Weight
69322	220-240 V; 50 Hz	700 W	NO	30 min	20 L	Ø24,5 cm	31,5x29,7x19,8 cm	45,2x33,5x26,2 cm	11,30 Kg



Horno microondas con plato giratorio + grill COMBI

Four micro-ondes avec plateau tournant + Grill · Mikrowelle mit Drehteller + Grill
Microwave oven with turntable + grill · Microondas com prato giratório + grill

	Ref	€	W	L	U.Venta
A	69323	268,20	800	23	1
B	69324	291,90	900	25	1
C	69330	351,40	900	30	1

Ref	Tensión/Voltage	Potencia/Power	Pot. Grill/Grill power	Capacidad/Capacity	Plato/Plateau	D. int/Int. size	Dimensiones/Sizes	Peso/Weight
69323	220-240 V; 50 Hz	800 W	1000 W	23 L	Ø27 cm	33x32x20,5 cm	48,5x41x29 cm	15,5 Kg
69324	220-240 V; 50 Hz	900 W	1000 W	25 L	Ø31,5 cm	35,5x33x21 cm	51x43x30 cm	14,3 Kg
69330	220-240 V; 50 Hz	900 W	1000 W	30 L	Ø31,5 cm	33x35,5x22,5 cm	52x40x32,5 cm	15,6 Kg

PLACAS INDUCCIÓN
Colección

Professional use



ES

- Placas de inducción rápidas, eficaces, seguras, fiables y de gran capacidad de calentamiento.
- Sus diseños portátiles y compactos resultan ideales para su uso en cualquier lugar.
- Botones táctiles, intuitivos y fáciles de utilizar con un toque suave.
- Dispone de función de bloqueo de seguridad para niños.
- 40% ahorro de tiempo y energía respecto a otras placas convencionales.

FR

- Plaque à induction rapide, efficace, sûre, fiable et d'une grande capacité de chauffe.
- Sa conception portable et compacte est idéale pour une utilisation n'importe où.
- Boutons tactiles, intuitifs et faciles à utiliser avec un toucher doux.
- Dispose d'une fonction de blocage de sécurité pour les enfants.
- 40% de gain de temps et d'économies d'énergies par rapport à d'autres plaques conventionnelles.

EN

- Fast, efficient, safe, reliable induction hob with high heating capacity.
- Its portable and compact design is ideal for use anywhere.
- Intuitive and easy to use soft touch buttons.
- Includes a child safety lock function.
- 40% saving in time and energy compared to other conventional hobs.

Superficie de calentamiento
Heating surface



Ø12
cm
min

Ø28
cm
max



IPX3
proof

Superficie de calentamiento
Heating surface



Ø12
cm
min

Ø28
cm
max



Placa inducción profesional CHEF

Plaque induction professionnelle · Profi-Induktionsplatte
Professional induction cooktop · Placa de indução profissional

Ref	€	W	U.Venta
69132	431,40	3500	1

Ref	Tensión/Voltage	Potencia/Power	Niveles Pot. /P. levels	Temperatura/Temp.	Reloj/Timer	Dimensiones/Sizes	Peso/Weight
69132	220-240 V; 50/60 Hz	3500 W	17	35°C - 240°C	0 - 180 min	34x43x12 cm	7,35 Kg
69337	220-240 V; 50/60 Hz	2700 W	10	60°C - 240°C	0 - 180 min	30x39x10 cm	5,40 Kg

Placa inducción profesional ROCA

Plaque induction professionnelle · Profi-Induktionsplatte
Professional induction cooktop · Placa de indução profissional

Ref	€	W	U.Venta
69337	364,70	2700	1

Superficie de calentamiento
Heating surface

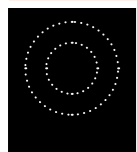

Ø12
cm
min

Ø28
cm
max



Placa inducción profesional EASY

Plaque induction professionnelle · Profi-Induktionsplatte
Professional induction cooktop · Placa de indução profissional

Ref	€	W	U.Venta
69362	370,10	3500	1

Superficie de calentamiento
Heating surface



Ø12
cm
min

Ø28
cm
max



Regulable en potencia
Adjustable in power

Placa de inducción PRO

Table de cuisine à induction · Induktionskochfeld
Induction cooker · Placa de indução

Ref	€	W	U.Venta
69371	333,90	500/3500	1

Ref	Tensión/Voltage	Potencia/Power	Niveles Pot. /P. levels	Niveles Temp. /T. levels	Dimensiones/Sizes	Peso/Weight
69362	220-240 V; 50/60 Hz	3500 W	10 (500W - 800W - 1100W - 1500W - 1800W - 2100W - 2500W - 2800W - 3100W - 3500W)	-	34x44,5x12,5 cm	7,00 Kg
69371	220-240 V; 50/60 Hz	500-3500 W	1-10 (500W (1) - 800W (2) - 1100W (3) - 1500W (4) - 1800W (5) - 2100W (6) - 2500W (7) - 2800W (8) - 3100W (9) - 3500W (10))	10 (60C - 80C - 100C - 120C - 140C - 160C - 180C - 200C - 220C - 240C)	36x38x12,5 cm	6,80 Kg

Superficie de calentamiento
Heating surface

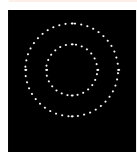

Ø12
cm
min

Ø22
cm
max



Placa de inducción EXPERT

Table de cuisine à induction · Induktionskochfeld
Induction cooker · Placa de indução

Ref	€	W	U.Venta
69032	279,30	2000	1

Posibilidad de encastrar
Encastrable option

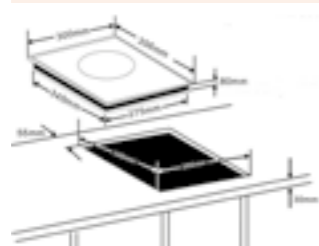

Superficie de calentamiento
Heating surface



Ø12
cm
min

Ø22
cm
max



Placa de inducción SLIM

Table de cuisine à induction · Induktionskochfeld
Induction cooker · Placa de indução

Ref	€	W	U.Venta
69332	158,40	2000	1

Ref	Tensión/Voltage	Potencia/Power	Niveles Pot. /P. levels	Reloj/Timer	Dimensiones/Sizes	Peso/Weight
69032	220-240 V; 50/60 Hz	2000 W	6	0 - 180 min	31x36x7,5 cm	2,90 Kg
69332	220-240 V; 50/60 Hz	2000 W	8	0 - 180 min	30x37x4,5 cm	2,67 Kg

Superficie de calentamiento
Heating surface



Ø22
cm
max

Ø12
cm
min



Placa inducción DUAL VERTICAL

Plaque induction double · Induktionskochfeld doppelt
Double induction cooktop · Placa de indução dupla

Ref	€	W	U.Venta
69033	457,20	1800+1300	1

Ref	Tensión/Voltage	Potencia/Power	Niveles Pot. /P. levels	Reloj/Timer	Dimensiones/Sizes	Peso/Weight
69033	220-240 V; 50/60 Hz	1800 +1300 W	8	0 - 99 min	29x51x9 cm	4,50 Kg
69333	220-240 V; 50/60 Hz	2000 W + 1500 W	7	0 - 180 min	60x34x7,5 cm	5,20 Kg

Superficie de calentamiento
Heating surface



Ø22
cm
max

Ø12
cm
min



Placa inducción DUAL HORIZONTAL

Plaque induction · Induktionskochfeld doppelt
Induction cooktop · Placa de indução

Ref	€	W	U.Venta
69333	270,20	2000+1500	1

- Cuerpo fabricado en 3 capas: acero inoxidable 18/10, aluminio, acero inoxidable 18%.
- La capa exterior es de acero inoxidable con componentes ferríticos, lo que la convierte totalmente compatible con las cocinas de inducción.
- Los mango fabricado en acero inoxidable 18/10 y recubierto con un protector térmico de silicona
- Body manufactured in a 3-layered: 18/19 stainless steel, aluminium, 18% stainless steel.
- Exterior layer, of stainless steel with ferrite materials, making it completely compatible with induction cookers.
- The grip are made in 18/10 stainless steel and covered in a silicon heat protection.



Wok Trimetal

Wok Trimetal · Wok, Trimetal
Trimetal wok · Wok Trimetal



Ref	€	Ø (cm)	L
53836	174,40	36	5,50

Inox

Placa cerámica: Ø26 cm
Ceramic plate: Ø26 cm

Placa inducción wok Profesional

Plaque à induction wok professionnelle · Induktionskochplatte wok professional
Induction cooktop wok professional · Placa indução wok profissional

Ref	€	U.Venta
69138	448,00	1

Ref	Tensión/Voltage	Potencia/Power	Temperatura/Temp	Tiempo/Timer	Dimensiones/Sizes	Peso/Weight
69138	220-240 V; 50/60 Hz	3500 W	60°C - 240°C	0 - 180 min	34x44,5x12,5 cm	7,50 Kg



ENERGY

Placa vitrocerámica

Household use



Superficie de calentamiento
Heating surface



Placa vitrocerámica ENERGY

Plaque vitroceramique · Keramikkochfeld
Ceramic hob · Placa vitrocerámica

Ref	€	W	U.Venta
69232	112,30	2000	1

- Placa vitrocerámica rápida, eficaz, segura, fiable y de gran capacidad de calentamiento.
- Su diseño portátil y compacto resulta ideal para su uso en cualquier lugar.
- Área de cocción de 10 cm / 20 cm de diámetro.
- Botones táctiles, intuitivos y fáciles de utilizar con un toque suave.
- Indicadores luminosos.
- Dispone de función de bloqueo de seguridad para niños.
- Regulable en potencia y temperatura.
- Temporizador de 240 minutos con avisador acústico y auto desconexión.

- Plaque vitroceramique rapide, efficace, sûre, fiable et d'une grande capacité de chauffe.
- Sa conception portable et compacte est idéale pour une utilisation n'importe où.
- Zone de cuisson de 10 cm / 20 cm de diamètre.
- Boutons tactiles, intuitifs et faciles à utiliser avec un toucher doux.
- Indicateurs lumineux.
- Dispose d'une fonction de blocage de sécurité pour les enfants.
- Réglable en puissance et en température.
- Minuteur de 240 minutes avec alerte sonore et arrêt automatique.

- Fast, efficient, safe, reliable ceramic hob with high heating capacity.
- Its portable and compact design is ideal for use anywhere.
- 10 cm / 20 cm diameter cooking area.
- Intuitive and easy to use with soft touch buttons.
- Luminous indicators.
- Includes a child safety lock function.
- Adjustable power and temperature.
- 240-minute timer with audible warning and auto-off.

Ref	Tensión/Voltage	Potencia/Power	Temperatura/Temp.	Temporizador/Timer	Ø cocción/Cooking	Dimensiones/Sizes	Peso/Weight
69232	220-240 V; 50/60 Hz	2000 W (8 levels)	60°C - 600°C (8 levels)	0 - 240 min (8 levels)	10 cm / 20 cm	39x32x5,5 cm	2,60 Kg

PROFESIONAL

PlANCHAS GRILL

Professional use



Techo móvil
Mobile roof



Salamandra PROFESIONAL

Salamandre Professionnelle · Professioneller Grill
Professional salamander grill · Salamandra Professional

Ref	€	W	U.Venta
69197	1217,50	4000	1

- Estructura de acero inoxidable.
- Ideal para calentar, asar, tostar o gratinar directamente los alimentos.
- Placa de calentamiento y techo móvil, ajusta a la posición deseada.

- Structure en acier inoxydable.
- Idéale pour chauffer, rôtir, griller ou gratiner directement les aliments.
- Plaque de chauffe et toit mobile avec réglage de la position souhaitée.

- Stainless steel structure.
- Ideal for directly heating, roasting, toasting or browning food.
- Movable heating plate and roof, adjusting the desired position.

Ref	Tensión/Voltage	Potencia/Power	Temperatura/Temp.	Plancha/Grill	Dimensiones/Sizes	Peso/Weight
69197	220-240 V; 50/60 Hz	4000 W	50°C - 300°C	59x32 cm	60x45x50 cm	49 Kg

Placa de 12 mm de espesor
Placa con superficie lisa de acero laminado y rectificado
12 mm thick plate
Laminated steel, flat surface griddle



Placa grill PROFESIONAL

Grill Professionnel · Profi-Grill
Professional grill plate · Grelhador Professional

Ref	€	W	Área cocción	U.Venta
A 69379	385,50	3000	40x40 cm	1
B 69179	791,90	6000	61x40 cm	1

Ref	Tensión/Voltage	Potencia/Power	Temperat./Temp.	Zona trabajo/Working zone	Superf. placa/Grill surface	Dimensiones/Sizes	Peso/Weight
69379	220-240 V; 50/60 Hz	3000 W	300°C	1	40x40 cm	41x51x26 cm	27 Kg
69179	220-240 V; 50/60 Hz	6000 W	300°C	2	61x40 cm	61,5x51x26 cm	37 Kg

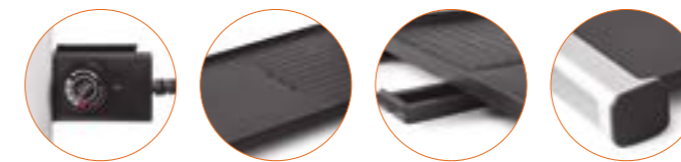

Plancha Grill QUALITY

Plancha & Grill · Grillplatte
Grill plate · Prancha & Grelhador

Ref	€	W	U.Venta
69227	84,40	2000	1

Ref	Tensión/Voltage	Potencia/Power	Temperatura/Temp.	Parilla/Grill	Dimensiones/Sizes	Peso/Weight
69227	220-240 V; 50/60 Hz	2000 W	0 - 230°C	52x30 cm	61x32,5x6 cm	3,20 Kg

Professional use

- Fabricada en acero inoxidable.
- Protector de salpicaduras.
- Placa con superficie lisa de acero laminado y rectificado, calentamiento uniforme.
- Control de temperatura por termostato hasta 300°C.
- Depósito recoge grasas.
- Especialmente indicada para bares, restaurantes, hoteles, etc.
- Para hacer a la plancha carnes, pescados, verduras, hortalizas, crepes, huevos, etc.

- Fabriqué en acier inoxydable.
- Protection contre les éclaboussures.
- Plaque avec surface lisse en acier laminé et rectifié, chauffe uniforme.
- Contrôle de température par thermostat jusqu'à 300°C.
- Réservoir ramasse-graisses.
- Spécialement indiquée pour les bars, restaurants, hôtels, etc.
- Pour faire à la plancha des viandes, poissons, légumes, crêpes, œufs, etc.

- Made in stainless steel.
- Splash guard.
- Laminated steel, flat surface griddle with uniform heating.
- Thermostat temperature control up to 300°C.
- Oil collector.
- Especially made for bars, restaurants, hotels, etc.
- To cook meat, fish, vegetables, crepes and eggs on the griddle...

AL
Aluminum

FU
Cast



Cuchillas de acero
inoxidable intercambiables
Interchangeable st. steel
blades



Rasqueta profesional para grill

Racloir professionnel pour grill · Professioneller grillschaber
Professional grill scraper · Raspador professional para grill

Ref	€	cm	L Cuchilla (cm)	U.Venta
67034	70,70	42x15x12	15	1

Household use

- Placa de aluminio fundido antiadherente de gran calidad, libre de PFOA.
- Doble zona de cocción para cocinar todo tipo de alimentos:
- * Grill: ideal para asar carnes, pescados, marisco, hamburguesas o verduras.
- * Lisa: ideal para preparar tortitas, huevos, tostadas o verduras.
- Alcanzan rápidamente la temperatura indicada.
- Garantizan una cocción uniforme por toda la superficie.
- Regulador de temperatura desmontable.
- La ranura central hace que la grasa se deposite en la bandeja recoge-grasas.
- Las asas con recubrimiento aislante de calor proporcionan seguridad.

- High-quality, non-stick, PFOA-free cast aluminium plate.
- Dual cooking area for cooking all kinds of food:
- * Grill: ideal for grilling meat, fish, seafood, hamburgers or vegetables.
- * Smooth: ideal for making pancakes, eggs, toast or vegetables.
- Quickly reaches the specified temperature.
- Ensures even cooking across the entire surface.
- Detachable temperature controller.
- Fat runs down the central groove and is gathered in the grease tray.
- Handles with heat-insulating coating for added safety.

JOIN Raclette Grill

Household use



ES

- Raclette fabricado con carcasa de acero inoxidable y placa de aluminio fundido con antiadherente de máxima calidad. Libre de PFOA.
- Placa reversible que dispone de una superficie acanalada y otra lisa. Superficie de cocción de 41x20 cm.
- Ajuste de temperatura variable (hasta 210°C) con anillo luminoso.
- Resistencia de 1400W distribuida uniformemente por toda la superficie para un calentamiento rápido y uniforme de los alimentos.
- 8 sartenes individuales con revestimiento esmaltado diferenciados por colores. Libres de PFOA.
- 8 espátulas de madera de haya para remover los alimentos y facilitar el momento de servir.
- Protección contra sobrecalentamiento.
- 100% estable: pies antideslizantes.
- Asas termoresistentes.
- Fácil de limpiar; placa y sartenes extraíbles.

FR

- Appareil à raclette fabriqué avec carcasse en acier inoxydable et plaque en fonte d'aluminium avec revêtement antiadhésif de la plus grande qualité. Sans PFOA.
- Plaque réversible qui dispose d'une surface cannelée et d'une autre lisse. Surface de cuisson : 41x20 cm.
- Réglage de température variable (jusqu'à 210°C) avec roulette lumineuse.
- Résistance de 1400W distribuée uniformément sur toute la surface pour une chauffe rapide et uniforme des aliments.
- 8 poêlons individuels avec revêtement émaillé différenciés par couleurs. Sans PFOA.
- 8 spatules en bois de hêtre pour remuer les aliments et faciliter au moment de servir.
- Protection contre la surchauffe.
- 100% stable, pieds antidérapants.
- Poignées thermo-résistantes.
- Facile à nettoyer ; plaque et poêlons extractibles.

EN

- Raclette made with a stainless steel body and a cast aluminium top with a maximum quality non-stick coating, PFOA free.
- Reversible top with a channelled surface and a smooth surface, 41x20 cm cooking surface.
- Variable temperature settings (up to 210° C) with a ring that lights up.
- 1400 W heating element distributed evenly over the entire surface so food can be heated quickly and evenly.
- 8 individual enamel coated frying pans in different colours, PFOA free.
- 8 beech wood spatulas for stirring food and serving.
- Overheating protection.
- 100% stable: non-slip feet.
- Heat-resistant handles.
- Easy to clean, removable top and frying pans.



Apta hasta 8 personas
Suitable up to 8 people



Termostato regulable con anillo luminoso
Adjustable thermostat with light ring

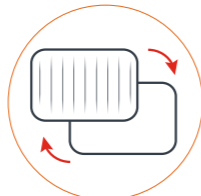

Plancha y parrilla reversibles. Amplía superficie de cocción de 41x20 cm
Reversible flat and grill plate. Large baking surface of 41x20 cm



8 sartenes individuales diferenciados por colores
8 individual frying pans differentiated by colors



Raclette Grill JOIN

Raclette Grill · Raclete-Grill
Grill raclette · Raclette Grill

Ref	€	W	U.Venta
69348	91,60	1400	1

Ref	Tensión/Voltage	Potencia/Power	Área cocción Cooking area	Área cocción mini sartén Área cocción mini sartén	Dimensiones/Sizes	Peso/Weight
69348	220-240 V; 50/60 Hz	1400 W	41x20 cm	8x8 cm	48x37,5x14,5 cm	2,70 Kg

TOTALLY & CONTROLLE Grill abatible



New

ES

- Diseñados para preparar sándwiches, paninis, verdura, carne, etc.
- 69572 - DualFunction: grill y plancha de asar; apertura 180° para aprovechar al máximo la superficie de cocinado doble.
- 69573 - Regulador de altura en 4 posiciones: ideal para alimentos delicados. Regulador de temperatura: regula la potencia de las placas para conseguir la cocción deseada (240°C máx).
- Placas de aluminio fundido antiadherente de máxima calidad, ECO y 100% libres de PFOA.
- Disponen de una bandeja de goteo extraíble apta para el lavavajillas.
- GreenLed: indicador luminoso de temperatura.
- TotalSafe: sistema antiquemadura. La carcasa y el asa permanecen fríos durante el uso.

FR

- Conçu pour préparer sandwichs chauds, paninis, légumes, viandes, etc.
- 69572 - DualFunction : grill et plancha ; ouverture à 180° pour exploiter au maximum la surface de cuisson double.
- 69573 - Réglage en hauteur en 4 positions : Idéal pour les aliments délicats. Régulateur de température : Régule la puissance des plaques pour obtenir la cuisson souhaitée (240°C max.).
- Plaques en fonte d'aluminium antiadhésif de la plus grande qualité, ECO et 100% sans PFOA.
- Dispose d'un plateau recueille-gouttes extractible apte pour le lave-vaisselle.
- GreenLed: indicateur de température lumineux.
- TotalSafe : système anti-brûlures. La carcasse et la poignée restent froides pendant son utilisation.

EN

- Designed to prepare sandwichs, paninis, vegetables, meat, etc.
- 69572 - DualFunction: Grill and griddle; fully opens 180° to maximise use of the double cooking area
- 69573 - Height adjustment in 4 positions: ideal for delicate foods. Temperature control: regulates heat of the hotplates to achieve the desired degree of doneness (240°C max.).
- Non-stick cast aluminium hotplates of the highest quality, ECO and 100% PFOA free.
- Features a removable, dishwasher-safe drip tray.
- GreenLed: temperature indicator light.
- TotalSafe: anti-burn system. Housing and handle remain cool during use.



180°

Grill abatible TOTALLY

Grill rabattable · Klappgrill
Contact grill · Grelhador rebatível

Ref	€	W	U.Venta
69572	51,40	1500	1

Grill abatible CONTROLLE

Grill rabattable · Klappgrill
Contact grill · Grelhador rebatível

Ref	€	W	U.Venta
69573	95,50	1500	1

Ref	Tensión/Voltage	Potencia/Power	Temperatura/Temp.	Área cocción/Cooking area	Dimensiones/Sizes	Peso/Weight
69572	220-240 V; 50/60 Hz	1500 W	180°C	26x16,5 cm (x2)	32x27x11 cm	1,90 Kg
69573	220-240 V; 50/60 Hz	1500 W	240°C	27x17,5 cm (x2)	33,5x28x12,5 cm	2,74 Kg

Professional use

Ideal para preparar carnes, pescados, verduras, bocadillos, etc. Placas onduladas. Placas en hierro colado
Placa superior regulable en altura. Abatible hasta 90°
Estructura de acero inoxidable
Mango aislante térmico
 Ideal for preparing meat, fish, vegetables, sandwiches, etc.
 Corrugated plates. Cast iron plates
 Height adjustable top plate. Folding up to 90°
 Stainless steel structure
 Thermal insulating handle



Plancha Grill

Grill · Grill
 Grill · Grelhar

Ref	€	W	U.Venta
A 69166	464,00	2200	1 SIMPLE
B 69167	724,20	4400	1 DOBLE · DOUBLE

Ref	Tensión/Voltage	Tensión/Voltage	Potencia/Power	Temp./Temp.	Temp./Temp.	Dimensiones/Sizes	Peso/Weight
69166	SIMPLE	220-240 V; 50/60 Hz	2200 W	300°C / 572°F (max)	50°C / 122°F (min)	31x31x20 cm	25 Kg
69167	DOBLE · DOUBLE	220-240 V; 50/60 Hz	4400 W	300°C / 572°F (max)	50°C / 122°F (min)	57x31x20 cm	35 Kg

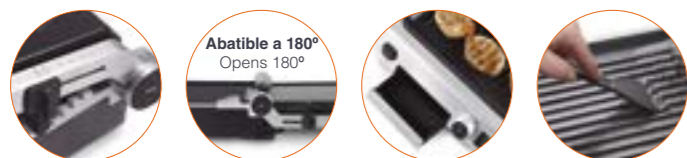

Abatible a 180°
 Opens 180°

Regulación en altura
 Height-adjustable



Grill abatible PRO

Grill rabattable · Klappgrill
 Contact grill · Grelhador rebatível

Ref	€	W	U.Venta
69574	261,60	2000	1

- Grill de gran calidad y robusto para uso profesional.
- Placas extraíbles de aluminio fundido antiadherente de gran calidad, libre de PFOA.
- Doble zona de cocción:
 - * Grill (27x22 cm): ideal para asar carnes, pescados, marisco, hamburguesas o verduras.
 - * Lisa (27x22 cm): ideal para preparar tortitas, huevos, tostadas o verduras.
- Alcanza rápidamente la temperatura indicada. Garantiza una cocción uniforme por toda la superficie.
- Regulación en altura. Regulador de potencia y temporizador de 30 minutos.
- Fácil extracción (botón) y colocación de las placas para facilitar su limpieza.
- Bandeja recoge grasas. Base antideslizante.
- Incluye espátula para la limpieza de las placas.

- Robust, high quality grill for commercial use.
- High quality, non-stick, PFOA-free, cast aluminium grill plates.
- Dual cooking area:
 - * Grill (27x22 cm): ideal for grilling meat, fish, seafood, hamburgers or vegetables.
 - * Smooth (27x22 cm): ideal for making pancakes, eggs, toast or vegetables.
- Quickly reaches the specified temperature. Ensures even cooking across the entire surface.
- Height-adjustable. 30-minute timer and power regulator.
- Grill plates are easy to remove (button) and replace, making them easy to clean.
- Drip tray. Non-slip base.
- Includes spatula for cleaning the grill plates.

Ref	Tensión/Voltage	Potencia/Power	Temperatura/Temp.	Temporizador/Timer	Parrilla/Grill	Dimensiones/Sizes	Peso/Weight
69574	220-240 V; 50/60 Hz	2000 W	0 - 230°C	0 - 30 min	27x22 cm	38x35x17 cm	6,0 Kg

SANDWICHERAS Colección

Household use



ES

- Tuesta y sella 2 sandwiches al mismo tiempo y consigue resultados increíbles.
- Placas con revestimiento antiadherente de alta calidad y libres de PFOA.
- Asa termorresistente, manipula la sandwichera con la máxima seguridad.
- Calentamiento rápido y uniforme. Indicadores led de encendido y calentamiento.
- Sistema de cierre y bloqueo sencillo y seguro.
- Compartimento para cable, posibilidad de almacenamiento vertical.
- Patas de goma antideslizantes.

FR

- Grille et presse 2 croques-monsieurs en même temps et obtient des résultats incroyables.
- Plaques dotées d'un revêtement antiadhésif de grande qualité et sans PFOA.
- Poignée thermorésistante afin de manipuler l'appareil en toute sécurité.
- Chauffe rapide et uniforme. Voyants lumineux de mise en marche et de chauffe.
- Système de fermeture et de blocage simple et sûr.
- Compartiment pour câble, possibilité de rangement vertical.
- Pieds en caoutchouc antidérapants.

EN

- Toast and seal 2 sandwiches at once, with incredible results.
- High quality non-stick plates that are PFOA free.
- The thermo-resistant handle lets you handle the sandwich maker with the utmost safety and no fear.
- Fast and even heating. LED power and heating indicators.
- Safe and simple closing and locking system.
- Cable compartment, can be stored vertically.
- Non-slip rubber feet.



Sandwichera BLACK

Appareil à sandwichs · Sandwichmaker
 Sandwich toaster · Sanduicheira

Ref	€	W	U.Venta
A 69147	30,80	750	1 Rectangular · Rectangular
B 69148	30,80	750	1 Triangular · triangular

Tuesta y sella 2 sandwiches al mismo tiempo
 Toast and seal 2 sandwiches at once

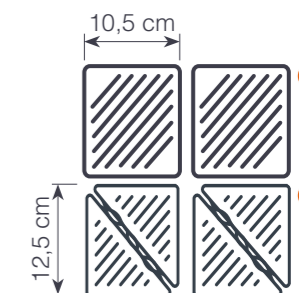

Tuesta y sella 2 sandwiches al mismo tiempo
 Toast and seal 2 sandwiches at once

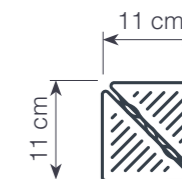

Sandwichera WHITE

Appareil à sandwichs · Sandwichmaker
 Sandwich toaster · Sanduicheira

Ref	€	W	U.Venta
69247	35,00	750	1

Ref	Tensión/Voltage	Potencia/Power	Sandwich	Dimensiones/Sizes	Peso/Weight
69247	220-240 V ; 50/60 Hz	750 W	11x11 cm (máx)	23x22x8,5 cm	1,450 Kg
69147	220-240 V; 50/60 Hz	750 W	10,5x12,5 cm (máx)	25x24x11 cm	1,66 Kg
69148	220-240 V; 50/60 Hz	750 W	10,5x12,5 cm (máx)	25x24x11 cm	1,66 Kg

GOFRERA

Colección

· Semiprofessional use ·

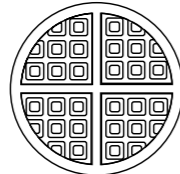

Ø18 cm del gofre
Waffle Ø18 cm



Placas en hierro colado
Cast iron plates

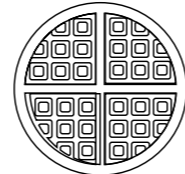

Gofre: Ø20 cm
Waffle: Ø20 cm



Gofrera

Gaufrier · Wendewaffeleisen
Waffle maker · Maquina de fazer goffresa

Ref	€	W	U.Venta
69349	303,20	1000	1

Gofrera Reversible

Gaufrier réversible · Wendewaffeleisen
Waffle maker · Maquina de fazer goffres reversível

Ref	€	W	U.Venta
69149	57,10	875	1

Ref	Tensión/Voltage	Potencia/Power	Temperat./Temp.	Tiempo/Timer	Placa Gofre/Waffle plate	Dimensiones/Sizes	Peso/Weight
69349	220-240 V; 50/60 Hz	1000 W	50°C - 300°C	5 min	Ø18 cm	26x44x26 cm	7 Kg
69149	220-240 V; 50/60 Hz	875 W			Ø20 cm	34x24x15 cm	1,98 Kg

REDONDO

Quemador

· Professional use ·



Incluye soporte
Includes support

Quemador eléctrico redondo

Fer à caraméliser électrique rond · Karamellisierer rund
Round electric caramelizer · Quemador eléctrico redondo

Ref	€	U.Venta
68651	114,70	1
68652	132,40	1

- Fabricada en acero inoxidable 18/10 con mango de plástico negro de excelente calidad.
- Diseñado para aplicaciones en cocina y repostería.
- Consta de una resistencia, que al conectarse a la corriente, se calienta.
- Incluye soporte.

- Fabriqué en acier inoxydable 18/10 avec un manche en plastique noir de haute qualité. Poignée en plastique noir.
- Conçu pour la cuisson et la pâtisserie.
- Composé d'un élément chauffant, qui se réchauffe lorsqu'il est branché sur le secteur.
- Socle inclus.

- Made of 18/10 stainless steel with a high quality black plastic handle.
- Designed for cooking and baking applications.
- Consists of a heating element, which heats up when connected to the mains.
- Includes stand

Ref	Tensión/Voltage	Potencia/Power	Dimensiones/Sizes	Peso/Weight
68651	220-230 V; 50/60 Hz	650 W	Ø10 cm	1,132 Kg
68652	220-230 V; 50/60 Hz	1000 W	Ø12 cm	1,268 Kg

CREPERAS

Colección

· Semiprofessional use ·



ES

- Crea crepes dulces y salados, pancakes y tortitas de una manera sencilla y cómoda.
- Rapidez, potencia y un calentamiento uniforme.
- Placa de aluminio antiadherente perfecta para hacer crepes degran tamaño.
- Incluye rastrillo de madera para extender la masa y conseguir un grosor homogéneo y espátula para voltear el crepe.

FR

- Faites des crêpes sucrées et salées, des pancakes et des petites galettes de façon simple et pratique.
- Rapidité, puissance et une chauffe uniforme.
- Plaque en aluminium antiadhésive, parfaite pour faire de grandes crêpes.
- Inclut râtelier en bois pour étaler la pâte et obtenir une épaisseur homogène, et une spatule pour retourner la crêpe.

EN

- Make sweet and savoury crêpes, pancakes and pikelets easily and conveniently.
- Speed, power and uniform heating.
- Non-stick aluminium plate, perfect for making large crêpes.
- Includes a wooden scraper for spreading the batter to achieve uniform thickness and a spatula to flip the crêpe.

Placa de aluminio antiadherente de Ø40 cm
Non-stick aluminium plate Ø40 cm



Inox

Placa crepera

Plaque crêpière · Crêpes-Kochplatte
Crepe maker · Placa crepeira

Ref	€	W	U.Venta
69196	489,20	3000	1

Placa de aluminio antiadherente de Ø30 cm
Non-stick aluminium plate Ø30 cm



Crepera

Crêpière · Crêpesplatte
Crepe maker · Crepeira

Ref	€	W	Color	U.Venta
A 69122	55,10	1000	BLACK	1
B 69222	73,80	1000	WHITE	1
C 69433	108,60	1500	TitanPro	1

New

Ref	Tensión/Voltage	Potencia/Power	Temperatura/Temp.	Placa/Grill	Dimensiones/Sizes	Peso/Weight
69196	220-240 V; 50/60 Hz	3000 W	50°C - 250°C	35 cm	45x49x22,5 cm	23 Kg
69122	220-240 V; 50/60 Hz	1000 W	200°C (max)	Ø30 cm	40x36x11 cm	2,12 Kg
69222	220-240 V; 50/60 Hz	1000 W	240 °C (max)	Ø30 cm	40x39x8 cm	1,72 Kg

New

Placa de aluminio antiadherente de Ø33 cm
Non-stick aluminium plate Ø33 cm



Crepera TitanPro

Crêpière · Crêpesplatte
Crepe maker · Crepeira

Ref	€	W	U.Venta
69433	108,60	1500	1



Placa de aluminio antiadherente de Ø30 cm
Non-stick aluminium plate Ø30 cm



CHOCOLATE

Baño María

· Semiprofessional use ·



Permite fundir chocolate y mantenerlo caliente
Cazo desmontable de acero inoxidable 18/10 de gran calidad

It allows you to melt chocolate and keep it hot
High quality 18/10 st. steel collapsible pan



Baño maría chocolate

Bain marie de chocolat 3 Bain Marie topf für Schokolade
Chocolate bain marie · Banho-maria chocolate

Ref	€	W	U.Venta
69317	41,70	50	1

Compatible con cubetas GN1/6 de Lacor
Calentamiento 3D
It's compatible with GN1/6 pans from Lacor
3D Heating



Baño maría chocolate

Bain marie de chocolat · Bain Marie topf für Schokolade
Chocolate bain marie · Banho-maria chocolate

Ref	€	W	U.Venta
69617	75,50	80	1

- Funcionamiento sencillo gracias a sus dos posiciones; una para fundir y otra para mantener el calor.
- Prepara fácilmente coberturas para tus postres.
- Añade especias (canela, jengibre en polvo, pimentas, vainilla) para obtener un chocolate más intenso.
- Puedes utilizarlo como una fondue; degustar brochetas de frutas, hojaldres, etc.
- Fonctionnement simple grâce à ses deux positions : l'une pour fondre et l'autre pour maintenir la chaleur.
- Préparez facilement des nappages pour vos desserts.
- Ajoutez des épices (cannelle, gingembre en poudre, poivre, vanille,...) pour obtenir un chocolat plus intense.
- Peut être utilisée comme pour une fondue : déguster des brochettes de fruits, des biscuits feuilletés, etc.
- Easy to use because it has two positions: one for melting and the other for containing heat.
- Make toppings for your desserts easily.
- Add spices (cinnamon, powdered ginger, pepper or vanilla) to get more intense chocolate.
- You can use it for fondue or with fruit skewers, puff pastries, etc.

- Perfecta para elaborar coberturas de alta calidad y mantenerlas a la temperatura deseada durante horas.
- Ideal para la obtención de un glaseado brillante para pasteles, tartas, cake pops, muffins, etc.
- Contenedor GN1/6 (1,50L) y tapa extraíble de acero inoxidable 18/10 para garantizar una rápida y efectiva limpieza (aptos para el lavavajillas).
- Regulación de temperatura por termostato de 0°C a 60°C
- Calentamiento 3D; el calor se distribuye de manera uniforme por toda la superficie del recipiente.
- Luz indicadora, se enciende tan pronto como se alcanza la temperatura deseada.

- Parfait pour élaborer des nappages de grande qualité et les garder à la température souhaitée pendant des heures.
- Idéal pour obtenir un glaçage brillant pour les gâteaux, tartes, cakes pop, muffins, etc.
- Conteneur GN1/6 (1,50L) et couvercle extractible en acier inoxydable 18/10 pour garantir un nettoyage rapide et efficace (compatibles avec le lave-vaisselle).
- Réglage de la température par thermostat de 0°C à 60°C
- Chauffe 3D ; la chaleur est répartie uniformément sur toute la surface du récipient.
- Indicateur lumineux, qui s'allume dès que la température souhaitée est atteinte.

- Perfect for making high quality toppings and keeping them at the desired temperature for hours
- Ideal for getting shiny glazing on pies, cakes, cake pops, muffins, and more
- It has a GN1/6 (1.5 L) container and removable 18/10 stainless steel lid to make cleaning fast and effective. Dishwasher safe.
- The temperature can be regulated with a thermostat from 0°C to 60°C.
- 3D Heating: Heat is distributed evenly over the entire surface of the container.
- The indicator lights up as soon as the desired temperature is reached.

Ref	Tensión/Voltage	Potencia/Power	Temperatura/Temp.	Capacidad/Capacity	Dimensiones/Sizes	Peso/Weight
69317	230-240 V / 50-60 Hz	50 W	40-50°C	1,0 L (máx)	29x22x12 cm	0,875 Kg
69617	230-240 V / 50-60 Hz	80 W	0-60°C	1,5 L (máx)	22,5x26x14,5 cm	1,250Kg

GREY PLUS

Fondue

· Household use ·



New



Fondue GREY PLUS

Fondue · Fondue
Fondue · Fonduel

Ref	€	W	L	U.Venta
69399	99,20	1500	1,20	1

Ref	Tensión/Voltage	Potencia/Power	Temperat./Temp.	Aceite/Oil	Capacidad/Capacity	Dimensiones/Sizes	Peso/Weight
69399	220-240 V; 50/60 Hz	1500 W	40°C - 95°C	190°C	1,20 L	29,5x21,5x24,5 cm	2,60 Kg

- Fondue eléctrica acabada en acero inoxidable de gran calidad. 1500W de potencia.
- Ideal para fundir queso, chocolate o calentar aceite.
- Olla de acero inoxidable desmontable y de 1,2 L de capacidad con fondo termodifusor para una distribución uniforme del calor.
- Termostato regulable para calentar y mantener los ingredientes siempre calientes.
- Protector antisalpicaduras extraíble con soporte para 8 tenedores.
- Incluye 8 tenedores de acero inoxidable y marcas de colores.
- Apagado de seguridad contra sobrecalentamiento.
- Pies antideslizantes. 100% estable.
- Olla, protector y tenedores aptos para el lavavajillas.

- High quality stainless steel electric fondue set. 1500 W power.
- Ideal for melting cheese, chocolate or heating oil.
- 1.2 L removable stainless steel pot with thermo-diffuser bottom for even heat distribution.
- Adjustable thermostat to heat and keep the ingredients hot at all times.
- Removable splash guard lid that holds 8 forks.
- Includes 8 stainless steel colour marked forks.
- Overheating safety function.
- Non-slip feet. 100% stable.
- Dishwasher safe pot, lid and forks

CHOCOSWEET

Chocolatera

· Professional use ·



5,0 l



Chocolatera CHOCOSWEET

Chocolatière · Schokoladenkocher
Chocolate machine · Chocolateira

Ref	€	W	L	U.Venta
69615	840,00	1000	5,0	1

Ref	Tensión/Voltage	Potencia/Power	Temperatura/Temp.	Capacidad/Capacity	Dimensiones/Sizes	Peso/Weight
69615	220-240 V; 50 Hz	1000 W	0°C - 90°C	5 L	28x41x46,5 cm	6,80 Kg

- Chocolatera profesional diseñada para mezclar y calentar chocolate al baño maría.
- Cubeta de policarbonato de 5 litros de capacidad.
- Termostato regulable de 0°C a 90°C.
- Sensor para prevenir posibles sobrecalentamientos.
- Sistema NonStop: movimiento continuo para conseguir resultados sin grumos y de consistencia perfecta.
- Grifo con sistema antigoteo y antiobstrucción, totalmente desmontable.
- Ideal para bares, restaurantes, cafeterías, hoteles, catering, foodtrucks, etc.
- Bandeja antigoteo con sistema de aviso.
- Base antideslizante. Fácil limpieza.

- Professional chocolate maker designed to mix and heat chocolate in a bain-marie.
- 5 litre capacity polycarbonate container.
- Adjustable 0°C to 90°C thermostat.
- Sensor to prevent possible overheating.
- NonStop System: Continuous motion for lump-free results and perfect consistency.
- Fully detachable tap with anti-drip and anti-clogging system.
- Ideal for bars, restaurants, cafés, hotels, catering, foodtrucks, etc.
- Non-drip tray with warning system.
- Non-slip base. Easy to clean.

CHOCOLATE Fuentes

· Semiprofessional use ·



Fuente de chocolate

Fontaine chocolat · Schokoladen Fontäne
Chocolate fountain · Fonte chocolate

Ref	€	W	Tower	U.Venta
A 69318	60,10	35	18 cm	1
B 69319	102,20	80	38 cm	1

Ref	Tensión/Voltage	Potencia/Power	Temperatura/Temp.	Capacidad/Capacity	Torre/Tower	Dimensiones/Sizes	Peso/Weight
69318	220-240 V; 50/60 Hz	35 W	40°C - 50°C	0,50 L (máx)	18 cm (height)	Ø16x30 cm	1,15 Kg
69319	220-240 V; 50/60 Hz	80 W	40°C - 50°C	1,80 L (máx)	38 cm (height)	Ø23x54,5 cm	2,05 Kg

DECORACIÓN

Aerógrafo con compresor

· Professional use ·



Aerógrafo con compresor

Aérographe avec compresseur · Airbrush Spritzpistole mit Kompressor
Airbrush with compressor · Aerógrafo com compressor

Ref	€	W	Presión	Caudal	U.Venta
69450	103,20	20	0 - 2 bar	0 - 10 L/min	1

Ref	Tensión Voltage	Potencia Power	Presión Pressure	Caudal aire Air flow	Capacidad Capacity	Long. tubo aire Air tube length	Aerógrafo Airbrush	Med. compresor Compressor size	Peso Weight
69450	220-240 V; 50/60 Hz	20 W	0 - 2 bar	0 - 10 L/min	7 ml	1,80 m	14,2x2,5x9	11,5x13,5x6 cm	800 g

CHAFING DISH Eléctrico

· Professional use ·



Cubeta GN 1/1 en Inox (h=65 mm / 8,50 L)
GN 1/1 st steel container (h=65 mm / 8,5 L)

Tapa y cubeta en inox incluidas
Stainless steel lid and bucket included



Chafing dish eléctrico

Chafing dish électrique · Elektrische Chafing Dish
Electric chafing dish · Chafing dish eléctrico

Ref	€	W	U.Venta
69336	178,10	900	1

Ref	Tensión/Voltage	Potencia/Power	Capacidad/Capacity	Temperatura/Temp.	Cubeta/Container	Dimensiones/Sizes	Peso/Weight
69336	220-240 V / 50-60 Hz	900 W	8,50 L	85°C (+/-10°C)	1GN 1/1 h=65 mm	55x34,5x25 cm	3,90 Kg



Calentador para chafing

Corp de chauffe pour bain marie · Heizung für chafing dish
Heating unit for chafing dish · Aquecedor para chafing dish

Ref	€	W	U.Venta
A 69002	185,60	700	1
B 69012	214,70	700	1

Con regulador · With regulator

Ref	Tensión/Voltage	Potencia/Power	Temp./Temp.	Dimensiones/Sizes	Adapt.
69002	220-240 V; 50/60 Hz	700 W	96°C (máx)	25x20 cm	69015-69000
69012	220-240 V; 50/60 Hz	700 W	92°C (máx)	25x20 cm	69001-69004 69110

- Ideal para el sector de la hostelería, restauración y catering.
- Mantiene la temperatura de los alimentos.
- Más seguro al carecer de llama de los geles.
- Tapa y cubeta extraíble GN 1/1 h=65 mm (8,50 L) fabricados en acero inoxidable de alta calidad. Cuerpo fabricado en polipropileno.
- Termostato regulable (85°C +/-10°C).
- Interruptor de encendido y apagado. Indicador luminoso.
- Protección contra sobrecalentamiento.
- Fácil de transportar gracias a sus asas laterales.
- 6 pies antideslizantes y resistentes para mantener la estabilidad.

- Parfait pour le secteur hôtelier, la restauration et le traiteur.
- Conserve la température des aliments.
- Plus sûr parce qu'il n'y a pas de flamme des gels.
- Couvercle et bac amovible GN 1/1 h=65 mm (8,50 L) en acier inoxydable de haute qualité. Corps fabriqué en polypropylène.
- Thermostat réglable (85 °C +/- 10 °C).
- Interrupteur marche/arrêt. Indicateur lumineux.
- Protection contre les surchauffes.
- Facile à transporter grâce à ses poignées latérales.
- 6 pieds antidérapants et résistants pour maintenir la stabilité.

- Ideal for the hospitality, restaurant and catering sectors.
- Maintains temperature of food.
- Safer than chafing dishes that use gel fuels.
- Removable lid and tray GN 1/1 h=65 mm (8.5 L) manufactured in high-quality stainless steel. Body manufactured in polypropylene.
- Adjustable thermostat (85°C +/-10°C).
- On / Off switch. Light indicator.
- Overheating protection.
- Easily portable using the side handles.
- 6 non-slip resistant bases to ensure stability.

Combinaciones posibles de cubetas · Possible tray options



6002+69012 available for:
69015 / 69004 / 69110



CALENTADORAS

Ollas

Professional use



ES

- Mantiene caliente todo tipo de sopas, salsas, consomés y líquidos.
- Ideal para cantidades grandes.
- Control de temperatura regulable por termostato.
- Cubeta interior desmontable.
- Alta resistencia y durabilidad.

FR

- Maintenir au chaud tout type de soupes, sauces, consommés, liquides, etc.
- Idéal pour de grandes quantités.
- Contrôle de la température réglable par thermostat.
- Seau intérieur amovible.
- Haute résistance et durabilité.

EN

- Keep all kinds of soups, sauces, consommés, liquids etc hot.
- Ideal for large amounts.
- Temperature control adjustable by thermostat.
- Removable inner bucket.
- High resistance and durability.



Inox 18/10



Inox 18/10



Capacidad: 10 L / Medidas: Ø24x25 cm
Repuesto para las ref.: 69037-69038
Capacity: 10 l / Sizes: Ø24x25 cm
Replacement for ref.: 69037-69038

Olla calentador sopa PROFESIONAL

Marmite Buffet chaud · Suppen- und Speisenwärmer
Soup kettle · Panela aquecedora de sopa

Ref	€	U.Venta	
A 69267	289,90	1	Inox 18/10 · 18/10 stainless steel
B 69037	173,90	1	Hierro esmaltado · Enameled iron
C 69038	245,20	1	Inox · St steel
D 69039	58,10	1	Repuesto · Replacement (69037-69038)

Ref	Tensión/Voltage	Potencia/Power	Temperatura/Temp.	Capacidad/Capacity	Dimensiones/Sizes	Peso/Weight
69267	220-240 V; 50/60 Hz	800 W	30°C - 90°C	11,0 L	Ø33x32 cm	4,50 Kg
69037	220-240 V; 50/60 Hz	400 - 475 W	30°C - 90°C	10,0 L	Ø34,5x36 cm	4,50 Kg
69038	220-240 V; 50/60 Hz	400 - 475 W	30°C - 90°C	10,0 L	Ø34,5x36 cm	4,50 Kg

BIBERONES

Calentador

Professional use



500 ml

Calentador de botellas biberón

Chauffe-sauces · Flaschenwärmer
Squeeze bottle warmer · Aquecedor de garrafas dispensadoras

Ref	€	W	U.Venta
69242	244,90	160	1
A R69242H	9,70	-	1

Ref	Tensión/Voltage	Potencia/Power	Temperatura/Temp.	Dimensiones/Sizes	Peso/Weight
69242	220-240 V ; 50/60 Hz	160 W	30°C - 80°C	30,5x25x23 cm	11,0 Kg

- Fabricada en acero inoxidable de alta calidad con aislamiento térmico.
- Sistema de calentamiento en seco y homogéneo.
- Permite mantener calientes preparaciones previamente elaboradas.
- Cómodo y fácil de usar.
- Termostato regulable de temperatura independiente.
- Incluye 2 botellas de 550ml de capacidad con 3 boquillas dispensadoras.
- Compatible con nuestras botellas biberón (Ref.: 61974-61977).

- Fabriqué en acier inoxydable de grande qualité avec isolation thermique.
- Système de chauffe à sec et homogène.
- Permet de garder au chaud les préparations préalablement élaborées.
- Pratique et facile à utiliser.
- Thermostat réglable indépendant.
- Inclut 2 flacons verseurs d'une capacité de 550 ml avec 3 becs verseurs.
- Compatible avec nos flacons verseurs (Réf. : 61974-61977).

- Made of high quality stainless steel with thermal insulation.
- Dry and homogeneous heating system.
- Lets you keep prepared food hot.
- Easy to use and convenient.
- Independent adjustable temperature thermostat.
- Includes two 550 ml bottles with capacity for 3 dispenser mouths.
- Compatible with our squeeze bottles (Ref.: 61974-61977).

GN 1/1

Baño María

Professional use

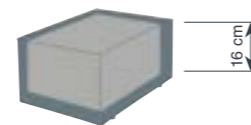

Combinaciones de cubetas posibles
Possible tray options



1 x GN 1/1 - 150



2 x GN 1/2 - 150



3 x GN 1/3 - 150

Baño maría GN 1/1 150 mm

Bain-marie en inox GN 1/1 150 mm · Bain Marie, GN 1/1 150 mm, Rostfrei
St. steel bain-marie GN 1/1 150 mm · Banho-maria GN 1/1 150 mm

Ref	€	W	U.Venta
69036	233,50	1300	1

Ref	Tensión/Voltage	Potencia/Power	Temperatura/Temp.	Capacidad/Capacity	Dimensiones/Sizes	Peso/Weight
69036	220-240 V; 50/60 Hz	1300 W	85°C	24 L	61,5x39x30 cm	8,50 Kg

PLACA CALENTAMIENTO

Colección

Professional use



Calentador BUFFET 3x GN 1/3

Chauffe · Warmer
Warmer · Aquecedor

Ref	€	W	U.Venta
69445	99,70	300	1



Placa calentamiento

Plaque pour Chauffante · Warmhalteplatte
Warming Plate · Placa aquecimiento

Ref	€	W	U.Venta
69045	92,50	300	1



Placa calentamiento Vitrocerámica

Plaque vitrocéramique chaleur · Glaskeramikeizplatte
Hob heating plate · Placa aquecimiento vitrocerámica

Ref	€	W	U.Venta
69145	204,70	230	1

- Una solución perfecta para profesionales de hostelería, buffet, eventos, catering, ferias...
- Ideal para mantener los alimentos calientes antes de servirlos en la mesa a una temperatura perfecta.
- NO cocinar sobre la misma placa.

- Une solution parfaite pour les professionnels de l'hôtellerie, buffets, événements, traiteurs, salons, ...
- Idéale pour garder au chaud d'aliments avant de les servir à table à une température parfaite.
- NE PAS cuisiner sur la même plaque.

- A perfect solution for hospitality, buffet, events, catering and trade show professionals...
- Ideal for keeping the food warm before serving them at a perfect temperature.
- DO NOT cook on the same tray.

- Una solución perfecta para profesionales de hostelería, buffet, eventos, catering, ferias, etc.
- Ideal para mantener tanto platos como bandejas de alimentos calientes antes de servirlos en la mesa a una temperatura perfecta.
- Fabricada en vidrio templado con un marco de aluminio.
- Termostato regulable en temperatura (65°C - 105°C).
- Prohibido cocinar sobre la misma placa.

- Une solution parfaite pour les professionnels de l'hôtellerie, buffets, événements, traiteurs, salons, ...
- Idéale pour garder au chaud aussi bien les assiettes que les plats d'aliments avant de les servir à table à une température parfaite.
- Fabriqué en verre trempé avec un cadre en aluminium.
- Thermostat réglable en température (65°C - 105°C).
- Il est strictement interdit de cuisiner sur la plaque.

- A perfect solution for hospitality, buffet, events, catering and trade show professionals...
- Ideal for keeping both dishes and trays of food warm before serving them at a perfect temperature.
- Made of tempered glass with an aluminum frame.
- Temperature-adjustable thermostat (65°C - 105°C).
- Do not cook on the hot plate.

New



Placa calentamiento Vitrocerámica

Plaque vitrocéramique chaleur · Glaskeramikeizplatte
Hob heating plate · Placa aquecimiento vitrocerámica

Ref	€	W	U.Venta
69446	101,30	230	1

BUFFET

Calentador

Professional use



ES

- Ideal para grandes cocinas, buffet, catering o comedores.
- Mantiene los platos a temperatura perfecta durante un tiempo prolongado.
- Estructura de acero inoxidable de alta calidad y resistente.
- Placa calentadora de acero inoxidable con regulación de temperatura entre 40°C - 90°C.
- Lámparas halógenas para garantizar una temperatura homogénea con regulación independiente para cada una de ellas.
- Pantalla protectora de plexiglas altamente resistente.

FR

- Idéal pour grandes cuisines, buffets, traiteurs ou cantines.
- Maintient les plats à la température parfaite pendant un laps de temps prolongé.
- Structure en acier inoxydable de grande qualité et résistant.
- Plaque chauffante en acier inoxydable avec réglage de température de 40°C à 90°C.
- Ampoules halogènes pour garantir une température homogène avec réglage indépendant pour chacune d'entre elles.
- Écran de protection en plexiglas hautement résistant.

EN

- Perfect for large kitchens, buffets, catering or dining rooms.
- It keeps food at the perfect temperature for an extended period.
- Durable high quality stainless steel structure.
- Stainless steel heating plate with adjustable temperature from 40° C to 90° C.
- The halogen lamps guarantee even temperature and each one can be adjusted independently.
- High impact perspex safety screen.



Incluye bombillas infrarrojos (Ref.: R69061A)
Includes infrared heating bulbs



Calentador BUFFET DUAL

Plaque électrique · Warmhalteplatte
Electric warming plate · Placa aquecimiento eléctrico

Ref	€	W (Placa)	W (Lámp.)	U.Venta
69562	519,20	500	2x250	1



Calentador BUFFET TRIPLE

Plaque électrique · Warmhalteplatte
Electric warming plate · Placa aquecimiento eléctrico

Ref	€	W (Placa)	W (Lámp.)	U.Venta
69563	684,10	650	3x250	1

Ref	Tensión/Voltage	Potencia/Power	Contenedor/Container	Temp. máx./ Max. temp.	Placa/Plate	Dimensiones/Sizes	Peso/Weight
69445	220-240 V; 50/60 Hz	300 W	GN 1/3 - 2,5 L (3)	80°C (max)	53x35,8 cm	65x38x15,4 cm	4,20 Kg
69045	220-240 V; 50/60 Hz	300 W	-	80°C (max)	53x35,5 cm	65x38x6,2 cm	2,60 Kg
69145	220-240 V; 50/60 Hz	230 W	-	60°C - 105°C (max)	55x36,5 cm	62x36,5x4,5 cm	4,10 Kg
69446	220-240 V; 50/60 Hz	230 W	-	60°C - 105°C (max)	38x45 cm	58x38x2,5 cm	3,54 Kg

Ref	Tensión/Voltage	Pot. Placa/Plate P.	Nº Lámp./Lamps	Pot. Lámp./Lamp P.	Temperatura/Temp.	Dimensiones/Sizes	Peso/Weight
69562	220-240 V; 50/60 Hz	500 W	2	250 W	40°C - 90°C	78x53x70 cm	12,5 Kg
69563	220-240 V; 50/60 Hz	650 W	3	250 W	40°C - 90°C	107x53x70 cm	16,5 Kg

CALENTAMIENTO

Lámparas

Professional use

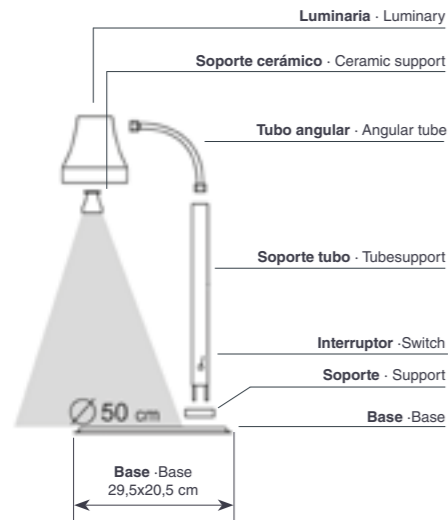

- Para uso profesional en hostelería.
- Mantiene calientes los platos. Calentamiento por infrarrojos.
- Se aconseja mantener la lámpara a 50 - 60 cm de distancia de los platos.
- Bombilla para todas nuestras lámparas de calentamiento.

- Pour un usage professionnel en hôtellerie.
- Maintient les plats au chaud. Chauffe par infrarouges.
- Il est conseillé de maintenir la lampe à une distance de 50 - 60 cm des plats.
- Ampoule pour toutes nos lampes chauffantes.

- For professional catering use.
- Hält die Speisen warm. Infrarot heating.
- It is recommended that the lamp is kept at a distance of 50-60cm from the plates.
- Bulb for all our heating lamps..



Incluye bombillas infrarrojos (Ref.: R69061A)
Includes infrared heating bulbs

Apta para todas nuestras lámparas de calentamiento
Suitable for all our heating lamps

Bombilla infrarrojos
Ampoule infrarouge · Infrarot Glühbirne
Infrared heating bulb · Lampada infravermelho

Ref	€	W	U.Venta
R69061A	9,80	275	1



Lámpara calentamiento infrarrojos
Lampe de chauffage infrarouge · Infrarot Wärmelampe
Infrared heating lamp · Lampara calor infravermelho

Ref	€	W	U.Venta
A 69361	105,10	275	1
B 69061	145,40	550	1

Ref	Tensión/Voltage	Potencia/Power	Dimensiones/Sizes	Peso/Weight
69361	220-240 V; 50/60 Hz	275 W	34x33x56 -71 cm	1,15 Kg
69061	220-240 V; 50/60 Hz	550 W	36x45x61 - 75 cm	1,58 Kg
69263	220-240 V; 50/60 Hz	275 W	31x23x79 cm	6,0 Kg
69264	220-240 V; 50/60 Hz	550 W	36x36x76 cm	7,0 Kg

CALENTAMIENTO

Lámparas extensibles

Professional use



- Para uso profesional en hostelería.
- Mantiene calientes los platos. Calentamiento por infrarrojos.
- Se aconseja mantener la lámpara a 50 - 60 cm de distancia de los platos.
- Bombilla para todas nuestras lámparas de calentamiento.

- Pour un usage professionnel en hôtellerie.
- Maintient les plats au chaud. Chauffe par infrarouges.
- Il est conseillé de maintenir la lampe à une distance de 50 - 60 cm des plats.
- Ampoule pour toutes nos lampes chauffantes.

- For professional catering use.
- Keeps the dishes warm. Infrared heating.
- It is recommended that the lamp is kept at a distance of 50-60cm from the plates.
- Bulb for all our heating lamps.



Incluye bombillas infrarrojos (Ref.: R69061A)
Includes infrared heating bulbs



Lámpara calentamiento infrarrojos cable extensible
Lampe de chauffage câble extensible · Infrarot Wärmelampe Kabel ausziehbar
Infrared heating lamp extensible · Lâmpara calor infravermelho cabo extensível

Ref	€	W	U.Venta	
A 69266	126,70	275	1	Lijado · Sanding
B 69365	145,60	275	1	Cromado · Chrome
C 69367	145,60	275	1	Cobre · Copper
D 69359	137,40	275	1	Negra · Black New

Lámpara de calentamiento extensible cónica
Lampe chauffante extensible conique · Wärmelampe Kabel ausziehbar, konisch
Conical heating lamp extensible · Lâmpada de aquecimento ext. cônica

Ref	€	W	U.Venta	
A 69564	131,20	275	1	Lijado · Sanding
B 69566	157,50	275	1	Cromado · Chrome
C 69565	160,20	275	1	Cobre · Copper
D 69576	147,00	275	1	Negra · Black New

Ref	Tensión/Voltage	Potencia/Power	Dist. lámp. alimentos Lamp-food distance	Peso/Weight
69266	220-240 V; 50/60 Hz	275 W	50 - 60 cm	2,00 Kg
69365	220-240 V; 50/60 Hz	275 W	50 - 60 cm	2,00 Kg
69367	220-240 V; 50/60 Hz	275 W	50 - 60 cm	2,00 Kg
69359	220-240 V; 50/60 Hz	275 W	50 - 60 cm	2,00 Kg
69564	220-240 V; 50/60 Hz	275 W	50 - 60 cm	1,60 Kg
69566	220-240 V; 50/60 Hz	275 W	50 - 60 cm	1,60 Kg
69565	220-240 V; 50/60 Hz	275 W	50 - 60 cm	1,60 Kg
69576	220-240 V; 50/60 Hz	275 W	50 - 60 cm	1,60 Kg

VITRINAS

Colección

Professional use



Parte trasera. Puertas traseras abatibles
Back side. Hinged rear doors



Vitrina neutra

Vitrine neutre · Einfache vitrine
Clear countertop display case · Vitrina neutra

Ref	€	cm	h (cm)	L	U.Venta
69601	285,30	55,4x37,6	37	45	1

- Vitrina neutra construida íntegramente en cristal y base de acero inoxidable.
- Diseñada para presentar y exponer sobre la barra / mostrador.
- Superficie superior curvada para una visión panorámica.
- Estante intermedio de cristal templado.
- Puerta trasera abatible.
- 4 pies de goma que garantizan máxima estabilidad.

- Vitrine neutre intégralement fabriquée en verre et base en acier inoxydable.
- Conçue pour présenter et exposer sur le plan de travail / comptoir.
- Surface supérieure courbée pour une vision panoramique.
- Étagère intermédiaire en verre trempé.
- Porte arrière rabattable.
- 4 pieds en caoutchouc qui garantissent une qualité maximale.

- Clear countertop display case made entirely of glass, including a stainless steel base.
- Designed for presenting and displaying food on the bar/countertop.
- Full view curved upper surface.
- Middle shelf made of tempered glass.
- Hinged rear door.
- 4 rubber feet for maximum stability.



Parte trasera. Puertas traseras abatibles
Back side. Hinged rear doors



Rejilla extraíble, facilita el flujo del calor
Removable racks for better heat flow



IPX4

Vitrina térmica

Vitrine thermique · Warmhaltevitrine
Thermal display case · Vitrina térmica

Ref	€	W	L	U.Venta
69604	577,00	800	45	1

- Vitrina térmica fabricada en acero inoxidable y cristal.
- Diseñada para conservar, presentar y exponer sobre la barra / mostrador.
- Puerta trasera abatible.
- Superficie superior inclinada para una visión panorámica.
- Recipiente de agua extraíble que aporta humedad en la cámara.
- Termostato de control de temperatura regulable: 30-90°C.
- Bandeja de rejilla extraíble que facilita el flujo del calor.

- Vitrine thermique fabriquée en acier inoxydable et verre.
- Conçue pour conserver, présenter et exposer sur le plan de travail / comptoir.
- Porte arrière rabattable.
- Surface supérieure inclinée pour une vision panoramique.
- Récipient d'eau extractible qui apporte de l'humidité à la chambre.
- Thermostat de contrôle pour régler la température : 30-90°C.
- Plateau grillagé extractible qui facilite le flux de chaleur.

- Thermal display case made of stainless steel and glass.
- Designed for storing, presenting and displaying food on the bar/countertop.
- Hinged rear door.
- Full view curved upper surface.
- Removable water tray to keep the chamber moist.
- Adjustable temperature control thermostat: 30-90°C.
- Removable racks for better heat flow.

Ref	Tensión/Voltage	Pot./Power	Capacidad/Capacity	Temp./Temp.	Protec./Protection	Parrilla/Grill	Parrilla/Grill (h)	Dimensiones/Sizes	Peso/Weight
69604	220-240 V; 50 Hz	800	45	30°C - 90°C	IPX4	52,5x28,5 cm	8,5 cm / 10 cm	55,4x37,6x37,6 cm	14,4 Kg



Parte trasera. Puertas traseras correderas.
4 / 6 cubetas gastronorm 1/3 incluidas
Back side. Sliding rear doors. 4/6 Gastronorm 1/3 trays included

IPX4

A



4 Cubetas Containers

B



6 Cubetas Containers

Vitrina térmica

Vitrine thermique · Warmhaltevitrine
Thermal display case · Vitrina térmica

Ref	€	W	Capacidad	U.Venta
A 69602	636,20	500	4xGN1/3	1
B 69603	731,40	800	6xGN1/3	1

Ref	Tensión/Voltage	Potencia/Power	Capacidad/Capacity	Temperatura/Temp.	Protección/Protection	Dimensiones/Sizes	Peso/Weight
69602	220-240 V; 50Hz	500 W	4 x GN 1/3	30°C - 90°C	IPX4	77,3x42x33,6 cm	16 Kg
69603	220-240 V; 50 Hz	800 W	6 x GN 1/3	30°C - 90°C	IPX4	112,7x42x33,6 cm	22 Kg

Parte trasera
Back side



Vitrina refrigerada

Vitrine réfrigérée · Kühlvitrine
Refrigerated display case · Vitrina refrigerada

Ref	€	W	L	U.Venta
69607	1084,00	105	40	1

Ref	Tensión/Voltage	Potencia/Power	Capacidad/Capacity	Temperatura/Temp.	Refrigerante/Refr.	Dimensiones/Sizes	Peso/Weight
69607	220-240 V; 50Hz	105 W	40	2°C - 12°C	R600a	68x57,5x33,5 cm	25 Kg

- Vitrina térmica fabricada en acero inoxidable y cristal.
- Diseñada para conservar, presentar y exponer sobre la barra / mostrador.
- Puertas correderas para una accesibilidad total.
- Superficie superior curvada para una visión panorámica.
- 4 / 6 cubetas gastronorm 1/3 incluidas.
- Termostato de control de temperatura regulable: 30 - 90°C.

- Vitrine thermique fabriquée en acier inoxydable et verre.
- Conçue pour conserver, présenter et exposer sur le plan de travail / comptoir.
- Portes coulissantes pour une accessibilité totale.
- Surface supérieure courbée pour une vision panoramique.
- 4 / 6 bacs gastronorm 1/3 inclus.
- Thermostat de contrôle pour régler la température : 30 - 90°C.

- Thermal display case made of stainless steel and glass.
- Designed for storing, presenting and displaying food on the bar/countertop.
- Sliding doors for easy access.
- Full view curved upper surface.
- 4/6 Gastronorm 1/3 trays included.
- Adjustable temperature control thermostat: 30 - 90°C.

69602

Combinaciones posibles
Possible combinations

GN 2/3	GN 2/3
GN 1/3	GN 1/3
GN 1/3	GN 1/3

69603

Combinaciones posibles
Possible combinations

GN 2/3	GN 2/3	GN 2/3
GN 1/2	GN 1/2	GN 1/2
GN 1/2	GN 1/2	GN 1/2
GN 1/3	GN 1/3	GN 1/3
GN 1/3	GN 1/3	GN 1/3
GN 1/3	GN 1/3	GN 1/3

- Vitrina refrigerada construida íntegramente en cristal y acero inoxidable.
- Diseñada para conservar, presentar y exponer sobre la barra / mostrador.
- Puertas correderas para una accesibilidad total.
- Superficie superior inclinada para una visión panorámica.
- Sistema de enfriamiento por compresor. Función Defrost.
- Termostato de control de temperatura regulable: 2-12°C.
- Sist. de iluminación LED en la cámara interior y display de control de mandos.

- Vitrine réfrigérée intégralement fabriquée en verre et acier inoxydable.
- Conçue pour conserver, présenter et exposer sur le plan de travail / comptoir.
- Portes coulissantes pour une accessibilité totale.
- Surface supérieure courbée pour une vision panoramique.
- Système de refroidissement par compresseur.
- Thermostat de contrôle pour régler la température : 0-12°C.
- Syst. d'éclairage LED dans la chambre intérieure et écran de contrôle de commandes.

- Refrigerated display case made entirely of glass, including a st. steel base.
- Designed for storing, presenting and displaying food on the bar/countertop.
- Sliding doors for easy access.
- Full view curved upper surface.
- Compressor cooling system. Defrost function.
- Adjustable temperature control thermostat: 2-12°C.
- LED lighting for inner chamber illumination and control display unit.



AGUA CALIENTE Dispensador

Household use

Inox CE  



ES

- Ideal para oficinas, casas rurales, reuniones, etc.
- Fácil llenado. Depósito extraíble de gran capacidad (2 L) para llenar fácilmente el contenedor.
- Display intuitivo. Elige la cantidad de agua (150 ml - 230 ml- 300 ml) y la temperatura deseada (25°C - 70°C - 85°C - 95°C).
- Cuenta con función de bloqueo de seguridad.
- Ahorra tiempo y energía. Proporciona la cantidad exacta de agua caliente deseada, el agua restante del depósito se mantendrá fría.
- Bandeja de goteo extraíble e imantada, fácil de limpiar y colocar.

FR

- Idéal pour les bureaux, les gîtes ruraux, les réunions, etc.
- Remplissage facile. Réservoir extractible de grande capacité (2 L) pour remplir facilement le conteneur.
- Écran intuitif. Choisissez la quantité d'eau (150 ml - 230 ml- 300 ml) et la température souhaitée (25°C - 70°C - 85°C - 95°C).
- Dispose d'une fonction de blocage de sécurité.
- Gain de temps et économies d'énergie. Fournit la quantité exacte d'eau chaude souhaitée, l'eau restant dans le réservoir restera froide.
- Plateau d'écoulement extractible et aimanté, facile à nettoyer et à installer.

EN

- Perfect for offices, country homes, meetings, etc.
- Easy to fill. Large capacity (2 L) removable tank to easily fill the container.
- Intuitive display. Choose the amount of water (150 ml - 230 ml- 300 ml) and the desired temperature (25°C - 70°C - 85°C - 95°C).
- Includes safety lock feature.
- Save time and energy. Provides the exact amount of hot water desired, while the remaining water in the tank remains cold.
- Removable and magnetic drip tray, easy to clean and replace.

- Vitrina refrigerada construida íntegramente en cristal y acero inoxidable.
- Diseñada para conservar, presentar y exponer sobre la barra / mostrador.
- Puertas correderas para una accesibilidad total.
- Superficie superior curvada para una visión panorámica.
- Sistema de enfriamiento por compresor.
- 4 / 6 cubetas gastronorm 1/3 incluidas.
- Termostato de control de temperatura regulable: 0-12°C.
- Sistema de iluminación LED en la cámara interior y display de control de mandos.

- Vitrine réfrigérée intégralement fabriquée en verre et acier inoxydable.
- Conçue pour conserver, présenter et exposer sur le plan de travail / comptoir.
- Portes coulissantes pour une accessibilité totale.
- Surface supérieure courbée pour une vision panoramique.
- Système de refroidissement par compresseur.
- 4 / 6 bacs gastronorm 1/3 inclus.
- Thermostat de contrôle pour régler la température : 0-12°C.
- Système d'éclairage LED dans la chambre intérieure et écran de contrôle de commandes.

- Refrigerated display case made entirely of glass, including a stainless steel base.
- Designed for storing, presenting and displaying food on the bar/counter top.
- Sliding doors for easy access.
- Full view curved upper surface.
- Compressor cooling system.
- 4/6 Gastronorm 1/3 trays included.
- Adjustable temperature control thermostat: 0-12°C.
- LED lighting for inner chamber illumination and control display unit.



Control de temperatura regulable
Temperature control thermostat



Tubo desagüe con tapón
Drain tube with cap

Puertas traseras correderas
Sliding rear doors

4
Cubetas
Containers



6
Cubetas
Containers



Vitrina refrigerada

Vitrine réfrigérée · Kühlvitrine
Refrigerated display case · Vitrina refrigerada

Ref	€	W	Capacidad	U.Venta
A 69605	1236,70	160	4xGN1/3	1
B 69606	1371,10	160	6xGN1/3	1

Ref	Tensión/Voltage	Potencia/Power	Capacidad/Capacity	Temperatura/Temp.	Refrigerante/Refrig.	Dimensiones/Sizes	Peso/Weight
69605	220-240 V; 50Hz	160 W	4 x GN 1/3	0°C - 12°C	R600a	112,1x45x33 cm	33 Kg
69606	220-240 V; 50 Hz	160 W	6 x GN 1/3	0°C - 12°C	R600a	148,3x45x33 cm	39 Kg

Agua caliente en 5 segundos
Hot water in 5 seconds

Bandeja de goteo extraíble e imantada
Removable and magnetic drip tray

Dispensador de agua caliente

Distributeur d'eau chaude · Heißwasserspender
Hot water dispenser · Dispensador de água quente

Ref	€	W	U.Venta
69298	124,50	2400	1

Ref	Tensión/Voltage	Potencia/Power	Capacidad/Cap.	Niveles Calentamiento Heating Levels	Dispensado agua Water dispensed	Dimensiones/Sizes	Peso/Weight
69298	220-240 V / 50-60 Hz	2400 W	2,00 L	25°C - 70°C - 85°C - 95°C	150-230-300 ml	32x16,8x32,7 cm	2,50 Kg

HERVIDORES AGUA

Colección

· Household use ·



ES

- Hervidor de agua retro fabricado en acero inoxidable 18/10, acabado en gris mate.
- Permite calentar el agua de manera rápida y eficiente.
- Botón luminoso de encendido/apagado.
- Base independiente rotativa de 360°.
- Control STRIX, vida útil superior al controlador estándar. Protección contra el calentamiento en vacío muy preciso. Apagado automático.
- Visor de nivel de agua. Boquilla con filtro. Mango termorresistente.

FR

- Bouilloire rétro fabriquée en acier inoxydable 18/10, finition gris mat.
- Permet de chauffer l'eau de façon rapide et efficace.
- Bouton lumineux de marche/arrêt.
- Base indépendante rotative à 360°.
- Contrôle STRIX, durée de vie utile supérieure au contrôleur standard. Protection contre la chauffe à vide très précis. Arrêt automatique.
- Visualisation du niveau d'eau. Buse avec filtre. Poignée thermo-résistant.

EN

- Retro kettle made of 18/10 stainless steel with a matte grey finish.
- It can be used to heat water quickly and efficiently.
- Illuminated on/off button.
- Independent base rotates 360°.
- STRIX controller: useful life longer than a standard controller. Very precise protection against heating while empty. Automatic Shut-off.
- Water level viewer. Nozzle with filter. Heat-resistant handle.



Base independiente rotativa de 360°
Independent base rotates 360°

Botón luminoso de encendido/apagado
Illuminated on/off button

Fácil llenado
Easy filling

Interior inox 18/10
Interior 18/10 st. steel

Boquilla con filtro
Nozzle with filter

Indicador de nivel de agua
Water level indicator

Strix
Technology

Hervidor de agua RETRO

Bouilloire électrique · Elektrische Wasserwamer
Electric kettle · Chaleira eléctrica

Ref	€	W	L	U.Venta
69397	58,20	2200	1,7	1

Ref	Tensión/Voltage	Potencia/Power	Capacidad/Capacity	Dimensiones/Sizes	Peso/Weight
69397	220-240 V ; 50/60 Hz	2200 W	1,70 L	26x19,5x26,5 cm	1,20 Kg



Filtro extraíble antical
Removable anti-cal filter



Visor de nivel de agua
Water level

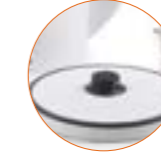

Base rotativa de 360°
360° rotating base



Calefactor oculto
Hidden heater

Hervidor de agua

Bouilloire · Wasserwamer
Kettle · Chaleira

	Ref	€	Color	W	L	U.Venta
A	69590	22,60	GREY	2200	1,30	1
B	69591	22,60	WHITE	2200	1,30	1

Ref	Tensión/Voltage	Potencia/Power	Capacidad/Capacity	Dimensiones/Sizes	Peso/Weight
69590	220-240 V; 50/60 Hz	2200 W	1,30 L	20x15x21 cm	0,74 Kg
69591	220-240 V; 50/60 Hz	2200 W	1,30 L	20x15x21 cm	0,74 Kg

Strix
Technology



Hervidor de agua LAKE

Bouilloire · Wasserwamer
Kettle · Chaleira

Ref	€	W	L	U.Venta
69277	59,70	2200	1,70	1

Ref	Tensión/Voltage	Potencia/Power	Capacidad/Capacity	Dimensiones/Sizes	Peso/Weight
69277	220-240 V; 50/60 Hz	2200 W	1,70 L (5 min)	23x16x23 cm	1,00 Kg
69291	220-240 V; 50/60 Hz	1630 W	1,00 L (3 min)	22x16x21 cm	1,10 Kg
69297	220-240 V; 50/60 Hz	2200 W	1,70 L (5 min)	22x18x23 cm	1,65 Kg

Hervidor de agua RAPID

Bouilloire · Wasserwamer
Kettle · Chaleira

Ref	€	W	L	U.Venta
69291	39,80	1630	1,00	1
69297	49,70	2200	1,70	1



Hervidor de agua
Bouilloire · Wasserwamer
Kettle · Chaleira

Ref	€	W	L	U.Venta
69292	80,70	2200	1,70	1

- Base para conector de 360°.
- Se apagará automáticamente cuando el agua hierve.
- Elemento de calefacción oculto.
- Indicador de luz de encendido/apagado.
- La temperatura se puede ajustar de 50°C-95°C.
- Almacenamiento de cable.

- Base pour connecteur de 360°.
- S'éteint automatiquement lorsque l'eau bout.
- Élément de chauffe caché.
- Indicateur lumineux de marche / arrêt.
- La température peut être réglée entre 50°C et 95°C.
- Rangement du câble.

- Base for 360° connector.
- The wireless boiler will automatically switch off when the water boils.
- Hidden heating element.
- ON/OFF light.
- The temperature can be adjusted from 50°C - 95°C.
- Cable storage.



Protección de ebullición en seco
Dry boil protection

Ref	Tensión/Voltage	Potencia/Power	Temperatura/Temp.	Capacidad/Capacity	Dimensiones/Sizes	Peso/Weight
69292	220-240 V; 50 Hz	2200 W	50 - 95°C	1,70 L	23x23x32 cm	1,90 Kg



- Cuerpo cerámico, ecológico y resistente a altas temperaturas.
- Base independiente rotativa de 360°.
- Tapa extraíble con cierre.
- Indicador de capacidad máxima.
- Interruptor de encendido/apagado luminoso.
- Protección de sobrecalentamiento y funcionamiento en seco.
- Función de apagado automático.

- Corps céramique, écologique et résistant aux températures élevées.
- Base indépendante rotative à 360°.
- Couvercle extractible avec fermeture.
- Indicateur de capacité maximale.
- Interrupteur de marche/arrêt lumineux.
- Protection contre la surchauffe et fonctionnement à sec.
- Fonction d'arrêt automatique.

- Ceramic body, ecological and resistant to high temperatures.
- 360° rotating independent base.
- Removable lid with closure.
- Maximum capacity indicator.
- Light up on/off switch.
- Protection from overheating and dry running.
- Auto-off function.



Interior inox 18/10. Calentamiento rápido
Interior 18/10 st. steel. Fast heating

Hervidor de agua cerámico
Bouilloire en céramique · Keramik Wasserwamer
Ceramic kettle · Chaleira cerâmica

Ref	€	Nombre	W	L	U.Venta
A 69276	51,70	GALA	1500	1,20	1
B 69289	56,50	GALA GREY	1200	1,00	1

Ref	Tensión/Voltage	Potencia/Power	Capacidad/Capacity	Dimensiones/Sizes	Peso/Weight
69276	220-240 V; 50/60 Hz	1500 W	1,2 L	24x17x25 cm	1,68 Kg
69289	220-240 V; 50/60 Hz	1200 W	1,0 L	23x16,5x23 cm	1,40 Kg

AIRPOT Cafetera

Professional use



NO UTILIZAR CON BEBIDAS GASEOSAS, CALDOS NI LÁCTEOS
DO NOT USE WITH FIZZY DRINKS, BROTHS OR DAIRY

- Dispensador con capacidades de 4, 6 y 10 litros.
- Fabricado en acero inoxidable resistente y de alta calidad.
- Dispone de un grifo dispensador con indicador de nivel de líquido.
- Temperatura controlada por termostato con un rango de 60°C a 100°C.
- Dispone de asas laterales aislantes del calor para un desplazamiento seguro.
- Ideal para agua, café y té.

- Distributeur d'une capacité de 4, 6 litres et de 10 litres.
- Fabriqué en acier inoxydable résistant et de grande qualité.
- Dispose d'un robinet de distribution avec indicateur du niveau de liquide.
- Température contrôlée par thermostat dans une tranche de 60°C à 100°C.
- Dispose de poignées latérales isolantes de la chaleur pour un déplacement sûr.
- Idéal pour l'eau, le café et le thé.

- 4, 6 and 10 litre capacity beverage dispensers.
- Made of strong high quality stainless steel.
- Includes a spigot with a level indicator.
- Temperature controlled by a thermostat with a range from 60°C to 100°C.
- Side mounted insulated handles for safe moving.
- Perfect for water, coffee and tea.



Airpot eléctrico

Électrique Airpot · Elektrische Getrankenpende
Electric Airpot · Airpot eléctrico

Ref	€	L	U.Venta
69472	131,00	4	1
69476	141,60	6	1
69471	154,60	10	1

Ref	Tensión/Voltage	Potencia/Power	Capacidad/Capacity	Temperatura/Temp.	Dimensiones/Sizes	Peso/Weight
69472	220-240 V / 50-60 Hz	1500 W	4 L	60°C - 100°C	28x28x35 cm	1,90 Kg
69476	220-240 V / 50-60 Hz	1500 W	6 L	60°C - 100°C	28x28x40 cm	2,00 Kg
69471	220-240 V / 50-60 Hz	1500 W	10 L	60°C - 100°C	28x28x48 cm	2,20 Kg

PERCOLADA Cafetera

Professional use



- Fabricada en acero inoxidable de gran calidad.
- Ideal para cafeterías, restaurantes, bares, servicios de buffet y estaciones self-service.
- 2 sistemas de calentamiento independientes para la función de infusión y la función de conservación del calor.
- Distribución de calor rápida y homogénea.
- Mantiene el café a la temperatura óptima salvaguardando sus propiedades de sabor y aroma durante horas.
- Filtro de malla microperforada de acero inoxidable, especialmente diseñado para evitar la generación de posos.
- Luz indicadora de preparación. Indicador del nivel de agua. Bandeja antigoteo.
- Tapa con cierre de seguridad mediante botón de bloqueo.
- Sistema de protección contra el calentamiento en vacío.
- Opción de flujo continuo para una máxima comodidad.
- Tapa, filtro y tubo percolador aptos para el lavavajillas.

- Made of high quality stainless steel.
- Perfect for cafés, restaurants, bars, buffet services and self-serve stations.
- Two independent heating systems for the infusion function and the heat preservation system.
- Fast and even heat distribution.
- Keeps coffee at the perfect temperature so it can retain its flavour and aroma for many hours.
- Stainless steel micro-perforated filter specially designed to prevent build-up.
- In-use indicator light. Water level indicator. Anti-drip tray.
- Lid with lock button activated safety lock.
- System to protect against heating while empty.
- Continuous flow option for maximum convenience.
- The lid, filter and percolator tube are dishwasher safe.



Filtro microperforado
Micro-perforated filter



Cafetera percoladora

Percolateur à café · Kaffee-Perkolator
Coffee percolator · Máquina/Percolador de café

Ref	€	W	L	U.Venta
69486	162,90	1500	6	1
69481	181,70	1500	10	1

Ref	Tensión/Voltage	Potencia/Power	Volumen/Volume	Capacidad/Capacity	Dimensiones/Sizes	Peso/Weight
69486	220-240 V; 50 Hz	1500 W	6 L	4,8 L (max)	28x28x40 cm	2,20 Kg
69481	220-240 V; 50 Hz	1500 W	10 L	8,2 L (max)	35x35x45 cm	2,80 Kg

MOLINILLOS

Colección

· Household use ·



19 diferentes niveles de molienda · 19 different grind sizes



Molinillo de café KALDI

Moulin à café · Kaffeemühle
Coffe grinder · Moedor de café

Ref	€	W	g	U.Venta
69485	117,70	200	200 / 100	1



Ideal para moler café y otros productos como semillas, hierbas, frutos secos, cereales, sal, pimienta, azúcar o especias

Perfect for grinding coffee or other products like seeds, herbs, nuts, grains, salt, pepper, sugar or spices

Cuchillas de acero inoxidable de gran resistencia
High strength st. steel blades



Molinillo de café LIMU

Moulin à café · Kaffeemühle
Coffe grinder · Moedor de café

Ref	€	W	g	U.Venta
69385	37,20	200	60	1

- Disfruta de todo el aroma y sabor de un café recién molido.
- Embudo de 200 g de capacidad con tapa.
- Fresa cónica de acero inoxidable, muele el café uniformemente.
- 19 diferentes niveles de molido. Se adapta a todo tipo de cafeteras y a la intensidad de sabor que se desee.
- Selector de tazas de 1 a 12 tazas. Mantiene los granos frescos y evita el desperdicio del café.
- Contenedor transparente extraíble de 100 g. Libre de BPA.

- Profitez de tout l'arôme et du goût du café fraîchement moulu.
- Entonnoir d'une capacité de 200 g avec couvercle.
- Une fraise conique en acier inoxydable, qui moule le café de manière régulière.
- 19 niveaux de mouture différents, elle s'adapte à tous les types de machines à café et à l'intensité de goût souhaitée.
- Sélecteur de tasses de 1 à 12 tasses, il permet de conserver la fraîcheur des grains et d'éviter le gaspillage de café.
- Récipient transparent amovible de 100 g. Sans BPA.

- Enjoy the taste and aroma of freshly ground coffee.
- Hopper with a capacity of 200 g with a lid.
- Conical stainless steel cutter to ensure the coffee is ground uniformly.
- 19 different grind sizes to choose from, suitable for all types of coffee machines and for all flavour intensities.
- Choose between 1 and 12 cups to keep the coffee grounds fresh and avoid wasting coffee.
- Removable 100 g transparent container. BPA-free.



Ref	Tensión/Voltage	Potencia/Power	Capacidad/Capacity	Niveles dispensado Levels dispensed	Niveles de molidos Grinding levels	Dimensiones/Sizes	Peso/Weight
69385	220-240 V ; 50/60 Hz	200 W	60 g (9 cups)	-	-	Ø10x18 cm	0,780 Kg
69485	220-240 V ; 50/60 Hz	200 W	200 g (granos · grains) 100 g (molido · ground)	12	19	15,2x21x26 cm	1,85 Kg

GOTEO

Cafeteras

· Professional use ·



- Puede dosificar la cantidad de café.
- Una vez encendida nos podemos desentender de ella.
- Si la jarra se completa, mantiene el café caliente y se puede consumir en cualquier momento.

- Peut doser la quantité de café.
- Une fois allumée, plus besoin de s'en occuper.
- Si la verseau est pleine, elle maintient le café au chaud permettant ainsi de le consommer à tout moment.

- The amount of coffee used can be controlled.
- Once switched on we can forget about it and leave it to work.
- If a full pot is prepared, it keeps the coffee hot and it can be consumed at any time.



Cafetera de goteo BLACK

Cafetière filtre électrique · Filter-Kaffeemaschine
Filter coffe machine · Café tipo filtro

Ref	€	W	L	U.Venta
69278	53,70	1000	1,25	1

Ref	Tensión/Voltage	Potencia/Power	Tazas/Cups	Capacidad/Capacity	Dimensiones/Sizes	Peso/Weight
69278	220-240 V; 50/60 Hz	1000 W	10	1,25 L	31x21x22 cm	1,25 Kg
69272	220-240 V; 50/60 Hz	2100 W	-	1,80 L (8 min)	20x36x41 cm	5x82Kg

Jarra café cristal

Basse en verre pichet · Glass Kaffee Krug
Glass coffee jug · Caneca de café em vidro

Ref	€	L	h (cm)	U.Venta
69273	29,10	1,80	17,50	1



Pack 200 filtros

Pack 200 filtres · Pack200 Filter
Pack filters U.Venta · Pack 200 filtros

Ref	€	Ø (cm)	U.Venta
69274	16,40	25	1
69275	14,10	20	1



2 Jarras Jugs
2x80 W (80°C +/-4)



Máquina de café automática

Machine à café automatique · Automatische Kaffeemaschine
Automatic coffee machine · Máquina automática do café

Ref	€	Filtro / Ø	U.Venta
69272	495,70	25	1

Placas de calentamiento independientes
Apta para todas las jarras de cristal
Independent heating plates
Suitable for all glass jars

Placa calentamiento jarra café

Plaque chauffante pour cruche de café · Heizplate für Kaffeekanne
Heating plate for coffee jug · Placa de aquecimento caneca de café

Ref	€	Ø Placa
69282	118,50	11



Ref	Tensión/Voltage	Potencia/Power	Temperatura/Temp.	Dimensiones/Sizes	Peso/Weight
69282	220-240 V; 50/60 Hz	180 W	80°C + 80°C +/-4	38x20,5x7 cm	1,50 Kg

CAFETERAS EXPRESSO

Colección

Household use

Inox CE



Prepara
1 o 2 cafés
Make 1 or 2 coffees

Calienta y espuma
la leche
Heat and froth milk



Cafetera espresso SENCE

Cafetière espresso · Espresso-Maschine
Espresso coffee maker · Cafeteira espresso

Ref	€	W	L	U.Venta
69256	184,20	850	1,50	1

- Cafetera espresso ideal para preparar todo tipo de cafés, espresso, cappuccino, latte machiato, etc.
- Conseguirás un café perfecto y rápido gracias a sus 15 bares de presión.
- Fácil de usar, muy intuitiva. Indicadores luminosos en cada función.
- Función manual y automática. Permite programar el ciclo de vertido a tu gusto.
- Incluye vaporizador con protección para espumar leche y preparar cappuccinos.
- Brazo portafiltros con doble salida, te permite preparar uno o dos cafés a la vez.
- Depósito de agua extraíble de 1,5 litros de capacidad con marcas de máximo y mínimo.
- Bandeja calienta tazas de acero inoxidable, calienta la taza previamente para evitar el contraste térmico.
- Incluye cucharilla dosificadora con prensador para el café y 3 filtros (individual, doble y para usar cápsulas ESE) para acoplar al brazo de la cafetera.
- Bandeja de goteo desmontable con indicador de nivel para facilitar la limpieza.
- Sistema de ahorro energético con apagado automático.
- Apta para usar con café molido y con cápsulas ESE.

- Espresso coffee machine, perfect for making all types of coffee, including espresso, cappuccino, latte, macchiato, etc.
- You'll have a perfect coffee in no time at all thanks to its 15 pressure bars.
- It's easy to use and very intuitive. Each function is accompanied by light indicators
- Manual and automatic settings. You can personalise the pouring time.
- Includes a steam wand with a protector for frothing milk, dispensing hot water for teas and preparing cappuccinos.
- The two-spout filter holder allows you to make one or two coffees at the same time.
- Removable 1.5-litre water tank with minimum and maximum water level marks.
- Stainless steel cup-warming tray heats up the cups before using them to keep the coffee warmer for longer.
- Includes a coffee measuring spoon and tamper and 2 filters (single, double and to use ESE capsules) to attach to the handle.
- Detachable drip tray with water level indicator to aid cleaning.
- Energy-saving system with automatic shut-off.
- Suitable for use with ground coffee and ESE capsules.



Prepara
1 o 2 cafés
Make 1 or 2 coffees

Calienta y espuma
la leche
Heat and froth milk



Cafetera espresso COMPACT

Cafetière espresso · Espresso-Maschine
Espresso coffee maker · Cafeteira espresso

Ref	€	W	L	U.Venta
69429	228,90	1450	1,25	1

- Ideal para preparar todo tipo de cafés, espresso, cappuccino, latte machiato, té o infusiones.
- Su sistema de calentamiento rápido Thermoblock calienta el agua en segundos.
- Fácil de usar, muy intuitiva. Indicadores luminosos en cada función.
- Función manual y automática. Permite programar el ciclo de vertido a tu gusto.
- Incluye vaporizador con rotación para espumar leche y preparar cappuccino. También dispensa agua caliente para las infusiones.
- Brazo portafiltros con doble salida, te permite preparar uno o dos cafés simultáneamente.
- Depósito de agua extraíble de 1,25 litros de capacidad con marcas de máximo y mínimo. Libre de BPA.
- Bandeja calienta tazas de acero inoxidable, calienta la taza previamente para evitar el contraste térmico.
- Incluye cucharilla dosificadora con prensador para el café y 3 filtros (individual, doble y para usar cápsulas ESE) para acoplar al brazo de la cafetera.
- Bandeja de goteo desmontable con indicador de nivel para facilitar la limpieza.
- Sistema de ahorro energético con apagado automático.
- Apta para usar con café molido y con cápsulas ESE.

- It's perfect for making all kinds of coffee, espresso, cappuccino, latte macchiato, tea or infusions.
- Its Thermoblock fast heating system heats water in seconds.
- It is easy to use and very intuitive and has light indicators for every function.
- Manual and automatic operation, the amount of coffee to be made can be programmed to taste.
- Swivelling steam wand included to froth milk and make cappuccino. It also dispenses hot water for infusions.
- The portafilter with two outlets lets you make one or two cups of coffee at the same time.
- It has a removable 1.25 litre water tank with minimum and maximum marks. BPA free.
- It has a stainless steel cup heating tray to heat cups beforehand to prevent temperature contrasts.
- It includes a spoon with a tamper for coffee and three filters (single, double and for using ESE pods) that attach to the portafilter.
- It has a removable drip tray with a level indicator to make cleaning easy.
- It has an energy savings system with automatic shut off.
- It can be used with ground coffee or ESE pods.

Ref	Tensión/Voltage	Potencia/Power	Presión/Pressure	Capacidad/Capacity	Dimensiones/Sizes	Peso/Weight
69429	220-240 V ; 50/60 Hz	1450 W	20 bar	1,25 L	14x31x31 cm	3,40 Kg

Ref	Tensión/Voltage	Potencia/Power	Presión/Pressure	Capacidad/Capacity	Dimensiones/Sizes	Peso/Weight
69256	220-240 V ; 50/60 Hz	850 W	15 bar	1,50 L	21x26,5x30 cm	3,60 Kg



Prepara
1 o 2 cafés
Make 1 or 2 coffees

Calienta y espuma
la leche
Heat and froth milk



Cafetera Espresso PRO

Cafetière espresso · Espresso-Maschine
Espresso coffee maker · Cafeteira espresso

Ref	€	W	L	U.Venta
69428	641,90	1550	2,80	1

- Cafetera espresso de acero inoxidable con acabado pulido.
- Ideal para preparar todo tipo de cafés, espresso, cappuccino, latte machiato, té o infusiones.
- Consigues un café perfecto y rápido gracias a su potencia de 1550 W y sus 20 bares de presión.
- Molinillo con fresa cónica de acero inoxidable integrado que proporciona la cantidad necesaria de café.
- Depósito de café de 250g con opción de regular entre 30 tipos de molido. Libre de BPA.
- Control de temperatura PID. Alcanza la temperatura de extracción óptima.
- Fácil de usar, muy intuitiva. Indicadores luminosos en cada función.
- Función manual y automática. Permite programar la cantidad de vertido a tu gusto.
- Incluye vaporizador con rotación para espumar leche y preparar cappuccino. También dispensa agua caliente para las infusiones.
- Brazo portafiltros con doble salida, te permite preparar uno o dos cafés simultáneamente.
- Depósito de agua extraíble de 2,8 litros de capacidad con marcas de máximo y mínimo. Libre de BPA.
- Incluye prensador de acero inoxidable para el café, 2 filtros (individual y doble) para acoplar al brazo de la cafetera y jarra de acero inoxidable de 0,46 L para la leche.
- Bandeja de goteo desmontable con indicador de nivel para facilitar la limpieza.
- Sistema de ahorro energético con apagado automático.

- Stainless steel espresso maker with a polished finish
- It's perfect for making all kinds of coffee, espresso, cappuccino, latte macchiato, tea or infusions.
- It can make perfect coffee quickly thanks to its 1550 W of power and 20 bars of pressure.
- A coffee grinder with a stainless steel cone burr that provides the right amount of coffee.
- It has a 250 g bean hopper and 30 types of grinding to choose from. It's BPA free.
- PID temperature control, it uses the optimum extraction temperature.
- It is easy to use and very intuitive and has light indicators for every function.
- Manual and automatic operation, the amount of coffee to be made can be programmed to taste.
- Swivelling steam wand included to froth milk and make cappuccino. It also dispenses hot water for infusions.
- The portafilter with two outlets lets you make one or two cups of coffee at the same time.
- It has a removable 2.8 litre water tank with minimum and maximum marks. BPA free.
- It includes a stainless steel tamper for coffee, two filters (single and double) that attach to the portafilter and a 0,46 L stainless steel pitcher for milk.
- It has a removable drip tray with a level indicator to make cleaning easy.
- It has an energy savings system with automatic shut off.

Ref	Tensión/Voltage	Potencia/Power	Presión/Pressure	Capacidad/Capacity	Capacidad/Capacity	Dimensiones/Sizes	Peso/Weight
69428	220-240 V ; 50/60 Hz	1550 W	20 bar	2,80 L (depósito agua)	250 g (depósito café)	31x34,5x41,5 cm	8,00 Kg

ESPUMADORES LECHE

Colección



ES

- Disfruta de una espuma fina y cremosa en pocos segundos.
- Capacidad espuma: 115 ml / Capac. calentamiento: 240 ml (69396) - 250 ml (69398).
- Tecnología magnética, el movimiento de los accesorios se crea por atracción (69398).
- Base independiente rotativa de 360°, fácil de rellenar y verter.
- Funcionamiento silencioso. Apagado automático.
- Indicador de luz que visualiza si la leche está caliente o fría.
- Apta para leches vegetales. Fácil de limpiar.

FR

- Obtenez une mousse fine et crémeuse en secondes seulement.
- Capacité de mousse : 115 ml / Capacité de chauffe : 240 ml (69396) - 250 ml (69398).
- Technologie magnétique, le mouvement des accessoires a lieu par attraction (69398).
- Base indépendante rotative de 360°C, sans fil, facile à remplir et à verser.
- Fonctionnement silencieux. Arrêt automatique.
- Indicateur lumineux qui indique si le lait est chaud ou froid.
- Apte pour les laits végétaux. Facile à nettoyer.

EN

- Enjoy a fine, creamy foam in a little seconds.
- Frothing capacity: 115 ml / Heating capacity: 240 ml (69396) - 250 ml (69398).
- Magnetic technology: The movement of the accessories is created with attraction (69398).
- 360° rotating independent base, easy to fill and pour.
- Silent operation. Automatic shut-off.
- The indicator light shows whether the milk is hot or cold.
- Suitable for plant milk and easy to clean.



Calentar y espumar.
Espumar leche fría
Heat and froth.
Froth cold milk



Calentar
Heat



Espumador de leche LATTE
Mousseur à lait · Milchaufschäumer
Milk frother · Espumador de leite

Ref	€	W	ml	U.Venta
69396	61,80	500	240	1



Espumador de leche MAGNETIC
Mousseur à lait · Milchaufschäumer
Milk frother · Espumador de leite

Ref	€	W	ml	U.Venta
69398	76,80	600	250	1

Ref	Tensión/Voltage	Potencia/Power	Cap. espuma/Cap. foam	Cap. leche/Cap. milk	Base/Base	Dimensiones/Sizes	Peso/Weight
69396	220-240 V; 50/60 Hz	500 W	115 ml	240 ml	360°	Ø10x21 cm	650 g
69398	220-240 V; 50/60 Hz	600 W	115 ml	250 ml	360°	Ø11,8x19,5 cm	900 g

TOSTADORAS BUFFET

Colección



Tostado continuo de pan
Doble sistema de calentamiento
Cinta transportadora
Bandeja de recogida de migas
Continuous bread toasting
Dual heating system
Conveyor belt
Crumb collection tray



Tostador CONTINUE

Grille-painl · Toaster
Toaster · Torradeira

Ref	€	W	U.Venta
69065	835,90	1340	1
69066	964,10	2240	1

Ref	Tensión/Voltage	Potencia/Power	Velocidad/Speed	Producción/Product.	Dimensiones/Sizes	Peso/Weight
69065	220-240 V; 50 Hz	1340 W	0,46 - 0,73 m/min.	150 h	53x37x40 cm	12,85 Kg
69066	220-240 V; 50 Hz	2240 W	0,46 - 0,73 m/min.	300 h	53x45x40 cm	15,50 Kg

Calentamiento infrarrojos
Lámparas infrarrojas halógenas de cuarzo
Hueco útil entre parrillas 5,5 cm
Bandeja recogemigas
Infrared heating Quartz halogen infrared lamps
Usable gap between racks 5.5 cm
Crumbs tray



Tostador HORIZONTAL

Grille-painl · Toaster
Toaster · Torradeira

Ref	€	W	U.Venta
A 69172	354,30	2400	1
B 69173	418,80	3150	1

Ref	Tensión/Voltage	Potencia/Power	Lámp./Lamps	Parrilla/Grill	Dimensiones/Sizes	Peso/Weight
69172	220-240 V; 50/60 Hz	2400 W	6 (3 + 3)	40x24 cm	50x25x28 cm	7,10 Kg
69173	220-240 V; 50/60 Hz	3150 W	9 (3 + 3 + 3)	40x24 cm	50x25x38cm	9,20 Kg

Ranuras de grandes dimensiones
Bandeja recogemigas
Huge slots for toasting
Crumbs tray



Tostador BUFFET

Grille-painl · Toaster
Toaster · Torradeira

Ref	€	Ranuras	U.Venta
A 69294	230,70	4	1
B 69296	306,40	6	1

Ref	Tensión/Voltage	Potencia/Power	Selector/Selector	Ranuras/Slots	Dimensiones/Sizes	Peso/Weight
69294	220-240 V; 50/60 Hz	1800 W	2-4 ranuras · 2-4 groves	15x3 cm	29x26x22 cm	3,90 Kg
69296	220-240 V; 50/60 Hz	2500 W	2-4-6 ranuras · 2-4-6 groves	15x3 cm	42x26x22 cm	5,00 Kg

TOSTADORAS

Colección

Household use



ES

- Fabricadas en acero inoxidable de máxima calidad y resistencia. Muy robustas.
- Regulador giratorio: 6 niveles de tostado (uniforme y homogéneo).
- Pantalla Led: indica el tiempo restante del tostado.
- Tres funciones: descongelar, recalentar y cancelar.
- Ranuras extra anchas y rejilla para recalentar pan, bollería, etc.
- Bandeja recogemigas extraíble para facilitar su limpieza.
- Recoge cable manual.
- Pies de goma antideslizante para una máxima estabilidad.

FR

- Fabriqué en acier inoxydable de la plus grande qualité et résistance. Très robustes.
- Régulateur giratoire : 6 niveaux de brunissage (uniforme et homogène).
- Écran Led : indique le temps restant.
- Trois fonctions : décongeler, griller et réchauffer.
- Rainures extra larges et grille pour réchauffer le pain, les viennoiseries, etc.
- Plateau ramasse-miettes extractible pour faciliter le nettoyage.
- Enrouleur de câble manuel.
- Pieds en caoutchouc antidérapants pour une stabilité maximale.

EN

- Made of top quality extremely tough stainless steel. Very strong.
- Rotating regulator: 6 toasting levels (even and homogeneous).
- LED Screen: shows the remaining toasting time.
- Three functions: defrost, cancel and reheat.
- Extra wide slots and a grill for reheating bread, pastries, etc.
- Removable crumb tray for easy cleaning.
- Manual cable retractor.
- Non-slip rubber feet for maximum stability.

A



B



C



Tostadora SMART

Grille-pain · Toaster
Toaster · Torradeira

Ref	€	W	U.Venta
A 69440	72,90	1500	1
B 69442	62,10	800	1
C 69444	87,50	1750	1

Ref	Tensión/Voltage	Potencia/Power	Ranuras/Slots	D. ranuras/Slots sizes	Dimensiones/Sizes	Peso/Weight
69440	220-240 V; 50/60 Hz	1500 W	2	3,8x25 cm	40,3x17,8x19 cm	2,40 Kg
69442	220-240 V; 50/60 Hz	800 W	2	3,8x14 cm	29,3x17,7x19 cm	1,65 Kg
69444	220-240 V; 50/60 Hz	1750 W	4	3,8x14 cm	28,8x31,5x19 cm	2,80 Kg



Ranuras de grandes dimensiones
Big slots for toasting

A



B



Tostadora CURVE

Grille-pain · Toaster
Toaster · Torradeira

Ref	€	W	U.Venta
A 69062	51,80	1000	1
B 69064	78,00	1750	1

Ref	Tensión/Voltage	Potencia/Power	Selector/Selector	Ranuras/Slots	Dimensiones/Sizes	Peso/Weight
69062	220-240 V; 50/60 Hz	1000 W	2 ranuras · 2 slots	14x4 cm	19x29x19 cm	1,40 Kg
69064	220-240 V; 50/60 Hz	1750 W	2-4 ranuras · 2-4 slots	14x4 cm	33x29x19cm	3,10 Kg

A



B



Tostadora horizontal

Toaster horizontal · Horizontal-/Toaster
Electric toaster · Torradeira horizontal

Ref	€	W	U.Venta
A 69163	33,00	600	1 BASIC
B 69363	41,30	600	1 EASY

Ref	Tensión/Voltage	Potencia/Power	Temperatura/Temp.	Tostado/Toasted	Parrilla/Grill	Dimensiones/Sizes	Peso/Weight
69163	220-240 V; 50/60 Hz	600 W	360°C	6	25x20 cm	36x21x6,5 cm	1,00 Kg
69363	220-240 V; 50/60 Hz	600 W	360°C	6	25x20 cm	42x30x9 cm	1,00 Kg

- Fabricada en acero inoxidable.
- Ranuras de grandes dimensiones (4x14 cm) para tostar cualquier tipo de pan.
- Permite tostar el pan de forma rápida, sencilla, sin ensuciar y sin necesidad de añadir grasa alguna.
- Funciones disponibles: tostar, descongelar, calentar.
- Selección del grado de tueste deseado en progresión continua (REHEAT · BAGEL · NORMAL · CANCEL).
- Expulsión automática.
- Bandeja recogemigas.
- Patas de apoyo antideslizantes.

- Fabriqué en acier inoxydable.
- Fentes de grandes dimensions (4x14 cm) pour faire griller tout type de pain.
- Il permet de faire griller le pain de manière rapide, simple, proprement et sans avoir besoin d'ajouter tous types de matières grasses.
- Fonctions disponibles : griller, décongeler, chauffer.
- Sélection du niveau de cuisson souhaité en progression continue (REHEAT · BAGEL · NORMAL · CANCEL).
- Éjection automatique.
- Tiroir ramasse-miettes.
- Pieds de soutien antidérapants.

- Made of Stainless Steel.
- Large 4 x 14 cm slots for toasting all kinds of bread.
- You can toast bread quickly, easily, without making a mess and without having to use any extra fat.
- Functions: toast, defrost, heat.
- Choose the toasting darkness along a sliding scale (REHEAT · BAGEL · NORMAL · CANCEL).
- Automatic ejection.
- Crumb Tray.
- Non-slip feet.

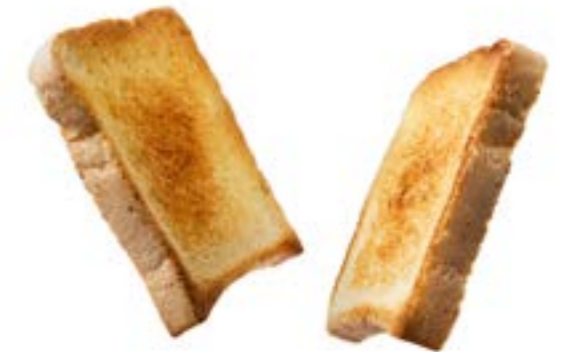

- Gracias a su diseño y área de calentamiento podrá tostar todo tipo de panes o bollería y varias rebanadas a la vez.
- Grâce à sa conception et sa zone de chauffe, vous pourrez griller tout type de pains ou de viennoiseries et plusieurs tranches à la fois.
- Dank des Designs und des Erwärmungsbereichs können Sie alle möglichen Brotsorten und mehrere Scheiben gleichzeitig toasten.
- Thanks to its design and heating area you will be able to toast all types of bread and pastries, and several slices at a time.
- Graças ao seu desenho e área de aquecimento, poderá tostar todo o tipo de pães ou bolos, e várias fatias ao mesmo tempo.

Household use

Inox New design



Tostadora LONG

Grille-pain · Toaster
Toaster · Torradeira

Ref	€	W	U.Venta
69260	57,60	1500	1

- Tostadora de doble ranura extralarga diseñada para tostar todo tipo de panes.
- Fabricada en acero inoxidable de gran calidad.
- Práctica, segura y muy fácil de usar.
- Función de descongelación (Defrost), calentamiento (Reheat) y cancelación (Stop).
- Bandeja recogemigas para facilitar la limpieza.
- Dispone de 7 niveles de tostado. Medidas de la ranura: 25 x 4 cm.

- Grille-pain à double rainure extra-large conçu pour griller tout type de pains.
- Fabriqué en acier inoxydable de grande qualité.
- Pratique, sûr et très facile à utiliser.
- Fonction de décongélation (Defrost), réchauffage (Reheat) et annulation (Stop).
- Plateau ramasse-miettes pour faciliter le nettoyage.
- Dispose de 7 niveaux de brunissage. Dimensions de la rainure : 25 x 4 cm.

- Extra-long double slot toaster designed to toast all types of bread.
- Made of high quality stainless steel.
- Practical, safe and easy to use.
- DEFROST, REHEAT and CANCEL functions.
- Removable crumb tray for easy cleaning.
- 7 browning levels. Slot dimensions: 25 x 4 cm



Doble ranura extralarga diseñada para tostar todo tipo de panes
Extra-long double slot toaster designed to toast all types of bread

Ref	Tensión/Voltage	Potencia/Power	Ranuras/Slots	Dimensiones/Sizes	Peso/Weight
69260	220-240 V; 50/60 Hz	1400 W	2	38x18x20 cm	1,70 Kg

Household use

- Fabricada en acero inoxidable 18/10 de gran calidad y resistencia
- Permite tostar de forma rápida y sencilla, sin necesidad de añadir grasa alguna
- Función de descongelación y cancelación
- Regulador ajustable de tueste, elige entre 7 niveles para tostar a tu gusto
- Ranura alargada de 25 cm de largo para rebanadas extra largas o para más de una rebanada de pan
- Incorpora una práctica bandeja, donde se depositan las migas

- Fabriqué en acier inoxydable 18/10 d'une grande qualité et résistance
- Permet de griller de façon rapide et simple sans nécessité d'ajouter aucune graisse
- Fonction de décongélation et d'arrêt
- Régulateur de brunissage réglable : choisissez parmi 7 niveaux pour griller selon vos souhaits
- Rainure allongée de 25 cm de longueur pour des tranches extra larges ou pour plus d'une tranche de pain
- Intègre un plateau pratique sur lequel se déposent les miettes

- Made of strong high quality 18/10 stainless steel
- Fast and easy toasting without the need to use any fatty products
- Defrost and cancel functions
- Adjustable darkness regulator. Choose from 7 levels for toasting as you like.
- Long 25 cm slot for extra wide slices of bread or more than one slice of bread at once
- It has a practical tray for catching crumbs



Ranura extralarga diseñada para tostar todo tipo de panes
Extra-long slot toaster designed to toast all types of bread

Tostadora DUPLO

Grille-pain · Toaster
Toaster · Torradeira

Ref	€	W	U.Venta
69360	63,70	1000	1

Ref	Tensión/Voltage	Potencia/Power	Ranuras/Slots	Dimensiones/Sizes	Peso/Weight
69360	220-240 V; 50/60 Hz	1000 W	1	41x12x18,5 cm	1,70 Kg

PROFESIONAL Exprimidor

Professional use



Exprimidor profesional INOX

Presse-fruits professionnelle · Profi-Zitruspresse
Professional squeezer · Espremedor profissional

Ref	€	W	U.Venta
69283	435,30	230	1

Ref	Tensión/Voltage	Potencia/Power	Velocidad/Speed	Dimensiones/Sizes	Peso/Weight
69283	220-240 V; 50/60 Hz	230 W	980 r.p.m.	28x20x40 cm	10,50 Kg

Inox 18/10

AL Aluminium

- Cuenta con una potencia de 230 W y materiales de gran calidad para que puedas exprimir todo tipo de frutas y cítricos.
- Sistema de puesta en marcha automático al presionar la palanca.
- Cono de acero inoxidable extraíble, apto para el lavavajillas hasta 90°C.
- Tiempo máximo en funcionamiento continuo: 30 minutos.

- Il possède une puissance de 230 W et des matériaux de grande qualité pour presser tout type de fruits et d'agrumes.
- Système de mise en marche automatique en appuyant sur le levier.
- Amovible cône en acier inoxydable, au lave-vaisselle jusqu'à 90°C.
- Temps de fonctionnement continu maximale: 30 minutes.

- Sie bringt eine Leistung von 230 W und besteht aus hochwertigen Materialien, damit Sie alle Arten von Obst und Zitrusfrüchten auspressen können.
- Automatisches Startsystem bei Drücken des Hebels.
- Abnehmbarer Edelstahl Kegel, spülmaschinenfest bis 90°C.
- Maximale Dauerbetriebszeit: 30 Minuten.

- It has 230 W power and is made from high quality materials so you can make juice from all types of fruits and citric fruits.
- Automatic starting when pressing the lever.
- Removable stainless steel cone, suitable to dishwasher up to 90°C.
- Maximum continuous operating time: 30 minutes.

- Com uma potência de 230 W e fabricado com materiais de grande qualidade, para que possa espremer todo o tipo de frutas e de cítricos.
- Sistema de posta em funcionamento automático ao pressionar a alavanca.
- Cone de aço inoxidável removível, laváveis até 90°C.
- Tempo máximo de funcionamento contínuo: 30 minutos.

Fe Hierro Iron

AS plastic

- Ideal para uso profesional intensivo por su potencia y velocidad, permite extraer el zumo con gran rapidez y sin esfuerzo.
- Constituido por un robusto bloque de hierro fundido.
- 3 conos diferentes, lo que permite obtener el máximo rendimiento de diferentes tipos de cítricos.
- El funcionamiento es muy sencillo: póngalo en marcha con el interruptor de encendido/apagado, coloque un vaso bajo la boquilla y presione las naranjas sobre el cono.
- Un colador separa la pulpa y vierte el zumo a través de la boquilla de salida.
- Incluye protector antisalpicaduras.

- Idéale pour un usage professionnel intensif grâce à sa puissance et sa vitesse, qui permettent d'extraire le jus très rapidement et sans efforts.
- Composée d'un bloc en fonte robuste.
- 3 cônes différents, ce qui permet d'obtenir le rendement maximum de différents types d'agrumes.
- Le fonctionnement est très simple : mettre la machine en marche à l'aide de l'interrupteur de marche/arrêt, placer un verre sous le bec et presser les oranges sur le cône.
- Un filtre sépare la pulpe et verse le jus à travers le bec de sortie.
- Inclut une protection anti-éclaboussures.

- Perfect for intensive professional use thanks to its power and speed, allowing you to quickly and effortlessly extract juice.
- Comprised of a robust cast iron body.
- 3 different cones, giving you optimal performance for different citrus fruits.
- Simple to use: press the on/off button, place a glass beneath the nozzle and squeeze the oranges on the cone.
- A sieve filters the pulp and the juice pours out of the nozzle.
- Includes an anti-splash protector.

Exprimidor profesional BLACK

Presse-fruits professionnelle · Profi-Zitruspresse
Professional squeezer · Espremedor profissional

Ref	€	W	U.Venta
69286	218,40	180	1

Ref	Tensión/Voltage	Potencia/Power	Velocidad/Speed	Dimensiones/Sizes	Peso/Weight
69286	220-240 V; 50/60 Hz	180 W	1.350 r.p.m.	31x22x35 cm	4,80 Kg

EXPRIMIDORES

Colección



ES

- Exprimidor robusto, seguro y eficiente, aprovecha todo el zumo de los cítricos sin esfuerzo.
- Cuerpo fabricado en acero inoxidable pintado en color blanco.
- Palanca ergonómica para un mejor agarre y un menor esfuerzo.
- Mecanismo potente capaz de exprimir los cítricos sin detenerse y sin pérdidas de potencia.
- Sistema de puesta en marcha automática al presionar la palanca, mantiene una presión suave hasta extraer todo el zumo.
- Sistema de bloqueo de salida de zumo y antigoteo.
- 100% estable: base con 4 ventosas.
- Fácil de limpiar. Accesorios desmontables y aptos para el lavavajillas.

FR

- Presse-fruits robuste, sûr et efficace, il presse tout le jus des agrumes sans efforts.
- Corps fabriqué en acier inoxydable peint en blanc.
- Levier ergonomique pour une meilleure prise en main et moins d'efforts.
- Mécanisme puissant capable de presser les agrumes sans s'arrêter et sans perte de puissance.
- Système de mise en marche automatique en appuyant sur le levier, maintenir une pression légère jusqu'à presser tout le jus.
- Système de blocage de la sortie du jus et système anti-goutte.
- 100% stable : base dotée de 4 ventouses
- Facile à nettoyer. Accessoires démontables et compatibles lave-vaisselle.

EN

- Strong, safe and efficient squeezer, so that you can effortlessly enjoy all citrus fruit juices.
- Stainless steel body painted in white.
- Ergonomic lever for better grip and minimal effort.
- Powerful mechanism capable of juicing citrus fruits without pausing and without loss of power.
- Automatic start-up upon pressing the lever, keep a light pressure until all juice is extracted.
- Juice output blocking and anti-drip system.
- 100% stable: its base has 4 suction cups for maximum stability.
- Easy to clean. Detachable, dishwasher-safe accessories.



Puesta en marcha automática al presionar la palanca
Dos conos para todo tipo de cítricos
Sist. de bloqueo de salida de zumo y antigoteo
 Automatic start-up upon pressing the lever
 Two cones for all kinds of citrus
 Anti-drip and juice outlet blockage system

Exprimidor de palanca VITALLY

Presse-fruit - Zitruspresse
 Orange squeezer - Espremedor de sumos

Ref	€	W	Color	U.Venta
A 69120	94,20	160	INOX	1
B 69231	126,40	160	WHITE	1

Ref	Tensión/Voltage	Potencia/Power	Dimensiones/Sizes	Peso/Weight
69120	220-240 V; 50/60 Hz	160 W	19,5x29x29 cm	2,50 Kg
69231	220-240 V; 50/60 Hz	160 W	19,5x29x29 cm	2,50 Kg



Puesta en marcha automática al presionar la palanca
Dos conos para todo tipo de cítricos
Sist. de bloqueo de salida de zumo y antigoteo
 Automatic start-up upon pressing the lever
 Two cones for all kinds of citrus
 Anti-drip and juice outlet blockage system

Exprimidor de palanca ENERGY

Presse-fruit - Zitruspresse
 Orange squeezer - Espremedor de sumos

Ref	€	W	U.Venta
69285	66,10	100	1

Ref	Tensión/Voltage	Potencia/Power	Dimensiones/Sizes	Peso/Weight
69285	220-240 V; 50 Hz	100 W	Ø20x29 cm	1,75 Kg



Accionamiento y puesta en marcha presionando el cono hacia abajo
Sist. de bloqueo de salida de zumo y antigoteo
 Activate just by pressing the cone downwards
 Anti-drip and juice outlet blockage system

Exprimidor de zumos

Presse-fruit - Zitruspresse
 Orange squeezer - Espremedor de sumos

Ref	€	W	U.Venta	
A 69287	66,80	100	1	SPIRIT
B 69280	54,80	100	1	POWER

Ref	Tensión/Voltage	Potencia/Power	Dimensiones/Sizes	Peso/Weight
69287	220-240 V; 50/60 Hz	100 W	18x16,5x25 cm	1,90 Kg
69280	220-240 V; 50/60 Hz	100 W	Ø14,5x25 cm	1,68 Kg



Accionamiento y puesta en marcha presionando el cono hacia abajo
Dos conos para todo tipo de cítricos
Sistema de pulpa regulable
 Activate just by pressing the cone downwards
 Two cones for all kinds of citrus
 Adjustable pulp system

Exprimidor de zumos ZITRUS

Presse-fruit - Zitruspresse
 Orange squeezer - Espremedor de sumos

Ref	€	W	L	U.Venta
69575	23,80	40	0,75	1

Ref	Tensión/Voltage	Potencia/Power	Capacidad/Capacity	Dimensiones/Sizes	Peso/Weight
69575	220-240 V; 50/60 Hz	40 W	750 ml (26 oz)	Ø19x20,5 cm	0,820 Kg



Con tapa
 With lid



Rotación automática en ambos sentidos
 Automatic rotation in both directions



Jarra extraíble graduada de 750 ml/26 onzas
 Removable 750ml/26oz capacity measuring jug

AUTOMÁTICO

Exprimidor



ES

- Exprimidor totalmente automático, gracias a su innovadora tecnología la fruta se exprime pulsando solo un botón.
- Mecanismo muy eficaz que exprime hasta la última gota del jugo de frutas.
- Gracias a su innovadora tecnología, no es necesario controlar la preparación del zumo.
- Cono universal que exprime sin problemas el jugo de los pomelos, naranjas, limones o limas.
- Sistema de bloqueo de salida de zumo y protección antigoteo.
- Sin salpicaduras durante el funcionamiento gracias a su tapa cerrada.
- Patas de goma antideslizantes.
- Todas las piezas son desmontables para una fácil limpieza y aptas para lavavajillas.

FR

- Presse-agrumes entièrement automatique ; les fruits sont pressés en appuyant sur un bouton.
- Mécanisme puissant qui presse jusqu'à la dernière goutte du jus des fruits.
- Grâce à sa technologie innovante, il n'est pas nécessaire de surveiller la préparation du jus.
- Cône universel qui presse sans problèmes le jus des pamplemousses, oranges, citrons ou citrons verts.
- Système de blocage de sortie et protection anti-goutte.
- Sans éclaboussures pendant le fonctionnement grâce à son couvercle fermé.
- Pieds en caoutchouc antidérapants.
- Toutes les pièces sont démontables pour un nettoyage facile, et aptes pour le lave-vaisselle.

EN

- This totally automatic juicer squeezes fruit with the touch of a button.
- It's powerful mechanism squeezes out the last drop of fruit juice.
- Thanks to its innovative technology, you don't have to watch whether it makes the juice.
- The universal cone easily squeezes juice from grapefruit, oranges, lemons and limes.
- It has a system for juice outlet blocking and drip protection.
- It doesn't splash while running thanks to its closed lid.
- Non-slip rubber feet.
- All the parts are removable for easy cleaning and they're also dishwasher safe.



Exprimidor automático

Presse-agrumes automatique · Automatische Saftpresse
Automatic juicer · Espremedor automático

Ref	€	W	ml	U.Venta
69520	82,60	60	400	1

Ref	Tensión/Voltage	Potencia/Power	Capacidad/Capacity	Dimensiones/Sizes	Peso/Weight
69520	220-240 V; 50/60 Hz	60 W	400 ml	20x19x31 cm	1,75 Kg



LICUADORAS

Colección



Los residuos son recogidos automáticamente
The residues are automatically collected



Tubo de entrada XL
XL inlet tube

Tapón
Plug

Licuada profesional PRO
Centrifugeuse professionel · Professioneller zitrus entsafter
Professional juice extractor · Liquidificador profesional

Ref	€	W	Kg/h	U.Venta
69488	1139,10	700	120	1

Ref	Tensión/Voltage	Potencia/Power	Par mot./M. torque	Conten. residuos/Waste container	Ø Entrada/Entry	Dimensiones/Sizes	Peso/Weight
69488	220-240 V; 50 Hz	700 W	2,9 Nm	6,0 L	9 cm	47,3x25,3x52,2 cm	13,20 Kg

Los residuos son recogidos automáticamente
The residues are automatically collected



Tubo de entrada XL
XL inlet tube

Incluye jarra de 1 L
1 l jar included

Licuada NUTRITY
Fruit centrifugeuse · Zitrus entsafter
Juice extractor · Liquidificador de sumos

Ref	€	W	L	U.Venta
69288	97,50	850	1,0	1

Ref	Tensión/Voltage	Potencia/Power	Par mot./M. torque	Cap.Capacity	Cont/ Container	Ø Entrada/Entry	Dimensiones/Sizes	Peso/Weight
69288	220-240 V; 50 Hz	850W	0,387 Nm	1,00 L	2,0 L	7,5 cm	30x20x36 cm	4,10 Kg

Professional use

- Fabricada en acero inoxidable de alta calidad muy robustas y potentes.
- Diseñada para uso continuo.
- Su potente motor, su gran velocidad y su gran orificio de entrada permiten preparar de forma rápida nutritivos zumos de frutas o verduras con expulsión automática de la pulpa.
- Contenedor de residuos de gran tamaño.
- Mecanismo de cierre con interruptor de seguridad.
- Filtro microperforado de acero inoxidable.
- Componentes desmontables, fáciles de limpiar.

- Fabriqué en acier inoxydable de grande qualité, très robuste et puissante. Conçue pour un usage continu.
- Son puissant moteur, sa grande vitesse et son large orifice d'entrée permettent de préparer rapidement des jus de fruits ou de légumes nutritifs avec une expulsion automatique de la pulpe.
- Conteneur de déchets de grande contenance.
- Mécanisme de fermeture avec interrupteur de sécurité.
- Filtre micro-perforé en acier inoxydable.
- Composants démontables, faciles à nettoyer.

- Extremely robust and powerful blender made of high quality stainless steel. Designed for continuous use.
- With its powerful motor, high speed, extra large opening and automatic pulp expulsion you can make nutritious fruit or vegetable juice quickly.
- Large waste container.
- Closing mechanism with a safety switch.
- Stainless steel micro-perforated filter.
- Easy to clean removable components.

Household use

- Fabricada en acero inoxidable de alta calidad muy robusta y potente.
- Diseñada para uso continuo.
- Su potente motor, su gran velocidad y su gran orificio de entrada permiten preparar de forma rápida nutritivos zumos de frutas o verduras con expulsión automática de la pulpa.
- Contenedor de residuos de gran tamaño.
- Mecanismo de cierre con interruptor de seguridad.
- Filtro microperforado de acero inoxidable.
- Componentes desmontables, fáciles de limpiar.

- Fabriqué en acier inoxydable de grande qualité, très robuste et puissante. Conçue pour un usage continu.
- Son puissant moteur, sa grande vitesse et son large orifice d'entrée permettent de préparer rapidement des jus de fruits ou de légumes nutritifs avec une expulsion automatique de la pulpe.
- Conteneur de déchets de grande contenance.
- Mécanisme de fermeture avec interrupteur de sécurité.
- Filtre micro-perforé en acier inoxydable.
- Composants démontables, faciles à nettoyer.

- Extremely robust and powerful blender made of high quality stainless steel. Designed for continuous use.
- With its powerful motor, high speed, extra large opening and automatic pulp expulsion you can make nutritious fruit or vegetable juice quickly.
- Large waste container.
- Closing mechanism with a safety switch.
- Stainless steel micro-perforated filter.
- Easy to clean removable components.



Exprime frutas y verduras enteras
Whole fruit / vegetables

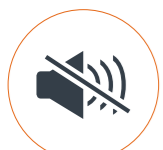

Bloqueo de salida
Juice stopper



Household use

- Tecnología "SLOW". Mediante el sistema de rotación lenta y el método de prensado en frío, permite obtener todos los nutrientes de frutas y verduras a diferencia de los exprimidores tradicionales. Ultrasilencioso gracias a su motor de bajas revoluciones.
- Mezcla frutas y verduras en el interior del recipiente antes de verterlo en la jarra.
- Introduce los ingredientes enteros permitiendo acelerar el tiempo dedicado a la extracción del zumo.
- Fácil limpieza. Cepillo para limpiar las partes internas. Accesorios aptos para el lavavajillas.

- Technologie "LENTE". Par son Systeme de rotation lente et la méthode de pression, cela permet de récupérer le maximum des ingrédients du fruit et légume à la différence des presses fruits traditionnels. Ultra silencieux. Grace à son moteur à basse tours.
- Capuchon à jus permettant de mélanger les fruits et légumes à l'intérieur du récipient avant de les verser dans les pichets.
- Introduire entièrement les fruits et légumes, gain de temps.
- Facile à nettoyer. Brosse fournit. Accessoires compatibles lave vaisselle.

- "SLOW" Rotation Engine. The slow rotation system facilitates a cold squeeze that allows the juice preserve all the nutritional properties from vegetables and fruits, unlike traditional squeezers. Ultra-silent. It's engine works in silence and eliminates unnecessary noise.
- Mixes all the desired fruits and vegetables inside the container before serving.
- The slow juicer lets you work with whole fruits and big pieces of vegetables.
- Easy cleaning. A brush incorporated for the inner parts. All pieces are dishwasher compatible.



Incluye **RECETARIO**
RECIPE BOOK included

Licuada ECOLO
Fruit centrifugeuse · Zitrus entsafter
Juice extractor · Liquidificador de sumos

Ref	€	W	U.Venta
69373	411,20	240	1

Ref	Tensión/Voltage	Potencia/Power	Velocidad/Speed	Capacidad/Capacity	Dimensiones/Sizes	Peso/Weight
69373	230 V; 50/60 Hz	240 W	60 r.p.m	1,0 L	29x20x44 cm	7,30 Kg

SOAK

Procesador de alimentos

Household use



4
Cuchillas
Blades

Procesador de alimentos SOAK
Robot culinaire · Küchenmaschine
Food processor · Processador de alimentos

Ref	€	W	L	U.Venta
69380	208,50	450	1,7	1

- Cocine sopas caseras, salsas, purés, cremas, batidos, zumos, cócteles, etc.
- Saltear ingredientes, cocinar a fuego lento o hervir sopas.
- Mezcla los ingredientes durante el proceso de cocción.
- Pica hielo en menos de 50 segundos y mezcla desde batidos hasta cócteles congelados.

- Cuisinez des soupes maison, des sauces, des purées, des crèmes, des milk-shakes, des jus de fruit, des cocktails, etc
- Sauter les ingrédients, cuisiner à feu doux ou faire bouillir des soupes.
- Mélange les ingrédients pendant le processus de cuisson.
- Pile la glace en moins de 50 secondes et mélange aussi bien des milk-shakes que des cocktails congelés.

- Prepare home-made soups, sauces, purées, creams, milkshakes, juices, cocktails, etc.
- Sautéing ingredients, cooking at low heat or boiling soups.
- Mixes the ingredients during the cooking process.
- Crushes ice in under 50 seconds and mixes anything from milkshakes to frozen cocktails.

Ref	Tensión/Voltage	Potencia/Power	Calentamiento/Heating	Velocidad/Speed	Capacidad/Capacity	Dimensiones/Sizes	Peso/Weight
69380	220-240 V; 50/60 Hz	450 W	700 - 900 W	17.000 r.p.m.	1,70 L	25x21x45 cm	2,40 Kg

PRO & MIX/GO

Batidora personales

Household use



ES

- Elabora sin esfuerzo batidos, cremas y zumos de fruta y verdura en segundos.
- Dispone de un potente motor de 1200 W diseñado para batir con facilidad (69389).
- Protección contra sobrecalentamiento.
- Las cuchillas de acero inoxidable pulverizan las semillas, cortan las pieles y trituran las partes densas y fibrosas de los alimentos hasta el punto de mantener la máxima cantidad de nutrientes.
- Funcionamiento muy sencillo, solo hay que presionar la jarra para que el motor active las cuchillas (69389).
- Incluye dos jarras de tritán libres de BPA (69389 - 1 L / 0,5 L) / (69382 - 600 ml / 300 ml), dos tapas y un asa que se acopla a los vasos para facilitar su agarre (69389).

FR

- Qui prépare sans efforts des smoothies, des crèmes et des jus de fruits et de légumes en quelques secondes.
- Dispose d'un puissant moteur de 1200 W conçu pour battre facilement (69389).
- Protection contre la surchauffe.
- Les lames en acier inoxydable pulvérisent les graines, coupent les peaux et triturent les parties denses et fibreuses des aliments afin de maintenir une quantité de nutriments maximale.
- Fonctionnement très simple, il suffit d'exercer une pression le bol pour que le moteur active les lames (69389).
- Inclut deux bols en tritan sans BPA (69389 - 1 L / 0,5 L) / (69382 - 600 ml / 300 ml), deux couvercles et une poignée qui s'emboîte aux bols pour faciliter leur prise en main (69389).

EN

- High quality blender, effortlessly prepares shakes, creams, and fruit and vegetables juices in seconds.
- Equipped with a powerful 1200 W motor designed for easy blending (69389).
- Overheating protection.
- Stainless steel blades grind seeds, cut skins, and purée dense, fibrous parts of the food to the point of maintaining the maximum amount of nutrients.
- Very easy to operate. Just press the pitcher to activate the blades of the motor (69389).
- Includes two (69389 - 1 L / 0,5 L) / (69382 - 600 ml / 300 ml) BPA free blender pitchers, two lids, and a handle that attaches to the cups for easy handling (69389).

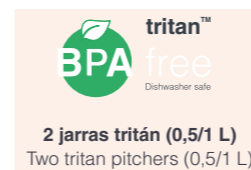

2 jarras tritán (0,5/1 L)
Two tritan pitchers (0,5/1 L)



Batidora personal PRO
Mixeur personnel · Mini-Standmixer
Individual blender · Batedeira pessoal

Ref	€	W	L	U.Venta
69389	99,90	1200	0,5 / 1,0	1



Batidora personal MIX & GO
Personnelle mixeur · Personliche mixer
Personal blender · Misturador pessoal

Ref	€	W	ml	U.Venta
69382	50,00	350	600/300	1

Ref	Tensión/Voltage	Potencia/Power	Jarras/Pitchers	Jarra pequeña Small jug	Jarra grande Big jug	Dimensiones/Sizes	Peso/Weight
69389	220-240 V ; 50/60 Hz	1200 W	2	0,5 L	1,0 L	14x14x40,5 cm	2,40 Kg
69382	220-240 V ; 50/60 Hz	350 W	2	0,3 L	0,6 L	12x12x40,5 cm	1,05 Kg

MIX & GO

Batidora personal c/jarra

Household use



ES

- Ideal para preparar pequeñas cantidades de cremas, batidos y zumos de fruta y verdura al instante.
- Compacta y de gran potencia (350 W), dispone de 4 cuchillas de acero inoxidable especiales para triturar hielo y moler semillas, frutos secos, cereales y café.
- Permite preparar y transportarlo en el mismo recipiente gracias a su jarra-vaso portátil.

FR

- Idéal pour préparer instantanément de petites quantités de crèmes, milk-shakes et jus de fruits et légumes.
- Compact et d'une grande puissance (350 W), il dispose de 4 lames en acier inoxydable spéciales pour piler la glace et mouler les graines, les fruits secs, les céréales et le café.
- Permet de préparer et de transporter les préparations dans le même récipient grâce à son pichet/verre portable.

EN

- Ideal for preparing small quantities of creams, smoothies and fruit and vegetable juices instantly.
- Compact and powerful (350 W), it has 4 special stainless steel blades for crushing ice and grinding seeds, nuts, cereals and coffee.
- Enables you to prepare and transport your juices or smoothies in the same container thanks to its portable.

Jarra de vidrio templado (500 ml)
High quality toughened glass (500 ml)



Incluye 4 pajitas desechables de papel ecológico
Includes 4 disposable straws made from eco-friendly paper

Batidora personal MIX & GO con jarra de cristal

Mixeur personnel MIX & GO avec bol en verre · Mini-Standmixer MIX & GO mit Glasbehälter
MIX & GO individual blender with glass jug · Batedeira pessoal MIX & GO com jarra de vidro

Ref	€	W	L	U.Venta
69386	46,60	350	0,50	1

Ref	Tensión/Voltage	Potencia/Power	Capacidad/Capacity	Altura jarra/Height jar	Dimensiones/Sizes	Peso/Weight
69386	220-240 V; 50/60 Hz	350 W	500 ml	23 cm	Ø12 x 31 cm	1,50 Kg



Cuchillas de acero inoxidable especiales para triturar hielo y moler semillas, frutos secos, cereales y café
Special stainless steel blades for crushing ice and grind seeds, nuts, cereals and coffee

Accesorios · Accessoires · Accessories

Apta para la batidora 69386/69382
Suitable for blender 69386/69382



Tapa de metal con orificio central para introducir la pajita
Metal lid with central hole for straw insertion



Set 2 jarras de cristal

Set de 2 pichets en verre · 2er-Set Glasbehälter
Set of 2 glass pitchers · Conjunto de 2 jarras de vidrio

Ref	€	ml	U.Venta
69387	19,10	500	1



Set 4 pajitas + cepillo

Set de pajitas + brosse · 4er-Set Strohhalme mit Reinigungsbürste
Set of 4 straws + cleaning brush · Conjunto de 4 palhinhas + escova

	Ref	€	Color	Ø (mm)	h (cm)	U.Venta
A	63131	4,90	Inox	6	21,5	1
B	69338	4,60	Inox	6	25,5	1
C	63132	7,30	Copper	6	21,5	1
D	63133	3,00	Cristal · Glass	6	21,5	12

No se deforman ni transmiten ningún sabor
Muy resistentes
Biodegradables
Certificación FDA, apta para el uso alimenticio
They don't distort or transfer any flavour
Very resistant
Biodegradable
FDA certified, suitable for use with food



Set 50 pajitas de papelecológicas

Set de 50 pailles en papier écologiques · Papierstrohhalme umweltfreundlich 50-er-Set
Set of 50 eco-friendly paper straws · Conjunto de 50 palhinhas de papel Ecológicas

Ref	€	Ø (mm)	h (cm)	e (mm)	g/mm2	U.Venta
69339	4,80	6	23	0,3	310	1

INOX: Pajitas reutilizables de acero inoxidable de gran calidad. No se oxidan, agrietan, rayan o rompen. La referencia 63132 destaca por su elegante acabado en color cobre. La mejor alternativa a las pajitas de plástico de un solo uso. Ecológicas, respetuosas con el medio ambiente. Incluye cepillo para facilitar la limpieza. Aptas para el lavavajillas.

CRISTAL: Fabricadas en cristal borosilicato de máxima calidad, resistente a los golpes. Extremadamente duraderas y seguras de usar. Esquinas redondeadas. Reutilizables, higiénicas y ecológicas. Fácil limpieza. Incluye cepillo. Aptas para el lavavajillas.

INOX: Pailles réutilisables en acier inoxydable de haute qualité. Ne rouillent pas, ne se fissurent pas, ne se rayent pas et ne se cassent pas. La référence 63132 se distingue par son élégante finition cuivrée. finition cuivrée. La meilleure alternative aux pailles en plastique à usage unique. Écologique, respectueuse de l'environnement. Brosse incluse pour un nettoyage facile. Passe au lave-vaisselle.

CRISTAL: Fabriqué en verre borosilicaté de haute qualité, résistant aux chocs. Extrêmement durable et sûr à utiliser. Coins arrondis. Réutilisable, hygiénique et écologique. Facile à nettoyer. Brosse incluse. Passe au lave-vaisselle.

INOX: High quality reusable stainless steel straws. They don't rust, crack, scratch or break. Reference 63132 stand out thanks to their elegant finish in copper color. The ideal alternative to single-use plastic straws. Environmentally friendly. Comes with a brush for easy cleaning. Dishwasher safe.

GLASS: Made of high-quality impact-resistant borosilicate glass. Extremely durable and safe to use. Rounded corners. Reusable, hygienic, and ecological. Easy cleaning. Includes brush. Dishwasher-safe.

BLACK & WHITE

Batidora profesional

Professional use



ES

- Potencia y resultados profesionales.
- Disfruta del placer de cocinar con la batidora profesional.
- Gracias a su gran rendimiento, potente motor, calidad y durabilidad lograrás resultados extraordinarios.
- La batidora ofrece una gran versatilidad y es ideal para elaborar todo tipo de zumos, batidos, sopas, salsas, patés, granizados, helados etc.
- Incluye un completo recetario con todo tipo de recetas diseñado por Lauri Bengochea (www.mitallerdebienestar.com) en exclusiva para Lacor.

FR

- Performance et résultats professionnels.
- Cuisinez avec plaisir grâce au Blender Professionnel.
- Sa performance, son puissant moteur, sa qualité et durée de vie vous donneront des résultats extraordinaires.
- Le blender offre une grande flexibilité et est idéal pour élaborer tout type de jus, smoothies, soupes, sauces, pâtés, granizado (boissons rafraîchissantes), glaces, etc.
- Il contient un livre de recettes élaboré par Lauri Bengochea (www.mitallerdebienestar.com) en exclusivité pour Lacor.

EN

- Power and Professional Results.
- Enjoy the pleasure of cooking with the Professional Mixer.
- Thanks to its high performance, powerful motor, quality and durability you'll get extraordinary results.
- The mixer is extremely versatile and perfect for making all kinds of juices, shakes, soups, sauces, pâtés, iced drinks, ice cream and more.
- It comes with a complete cookbook with all kinds of recipes designed exclusively for Lacor by Laura Bengochea (www.mitallerdebienestar.com).



Batir, picar y moler
Blend, chop and grind



Batidora profesional BLACK

Batteur professionnel · Profi-Mixer
Professional blender · Batedor profesional

Ref	€	W	L	U.Venta
69195	485,60	1200	2,0	1



Batidora profesional WHITE

Batteur professionnel · Profi-Mixer
Professional blender · Batedor profesional

Ref	€	W	L	U.Venta
69295	420,10	1200	1,5	1

Ref	Tensión/Voltage	Potencia/Power	Velocidad/Speed	Capacidad/Capacity	Dimensiones/Sizes	Peso/Weight
69195	220-240 V; 50/60 Hz	1200 W	13.300 - 38.000 r.p.m	2,0 L	28x26x52 cm	5,00 Kg
69295	220-240 V; 50/60 Hz	1200 W	13.000 - 38.000 r.p.m	1,5 L	18x24x42 cm	4,00 Kg

Accesorios · Accessoires · Accessories



Apta para las batidoras 69195 y 69295
Apt for blenders 69195 and 69295

Jarra batidora con cuchillas

Pot batteur avec lamestl · Krug mit Messer für Mixer
Blender jug with blades · Jarra batedora com lâminas

Ref	€	L	U.Venta
R69195N	190,50	2,0	1 Jarra · Jug
R69195B	48,00	2,0	1 Tapa · Lid



Apta para las batidoras 69195 y 69295
Apt for blenders 69195 and 69295

Jarra batidora con cuchillas

Pot batteur avec lamestl · Krug mit Messer für Mixer
Blender jug with blades · Jarra batedora com lâminas

Ref	€	L	U.Venta
R69295A	188,00	1,5	1 Jarra + Tapa · Jug + Lid
R69295D	74,70	-	1 Tapa · Lid



Carcasa aislante de ruido

Boîtier isolant du bruitl · Geräuschdämpfendes Gehäuse
Noise reducing enclosure · Carcaça isolante do ruído

Ref	€	cm	h (cm)	U.Venta
R69295B	244,10	25x30	46	1



Aísla y reduce el nivel de ruido un 80%. Apta para las batidoras 69195 y 69295.
Isolé et réduit le niveau de bruit de 80%. Apte pour les mixeurs 69195 et 69295.
Isolates and reduces the noise level by 80%. Apt for blenders 69195 and 69295.

NOTA
La carcasa solo es valida si las batidoras llevan la jarra baja (R69295A),
NUNCA con la jarra alta (R69195N).

REMARQUE
La carcasse n'est valable que si les mixeurs possèdent un bol bas
(R69295A), JAMAIS avec un bol haut (R69195N).

NOTE
The casing is only valid if the blender comes with a lower recipient
(R69295A), NEVER for a higher recipient (R69195N).



Posibilidad de encastrar.
Dimensiones del agujero: 25,5 x 26,5 cm.
Possibilité d'encastrar.
Dimensions du trou : 25,5 x 26,5 cm.
Encastrable option.
Dimensions of the hole: 25,5 x 26,5 cm.

INOX · WHITE · VITA

Batidoras

Household use

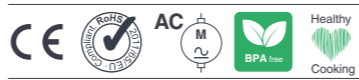

ES

69581 - Batidora INOX

- Ideal para elaborar todo tipo de zumos, batidos, cremas, salsas, granizados, etc.
- Potente motor de 1000 W para licuar, mezclar y triturar de manera rápida y eficaz.
- Control de velocidad variable con display luminoso, seleccione la velocidad deseada con la ruleta.
- Tres funciones pre-establecidas: Pulse · Ice crush · Smoothie.
- * Velocidad PULSE para batir al gusto a máxima velocidad.
- * Velocidad ICE CRUSH, función especial para picar hielo.
- Jarra de vidrio borosilicato con escala (ml / cups / oz) de alta calidad resistente a los arañazos de 1,50 L.
- Vaso medidor de 50 ml / 1-3 / 4 oz.
- 6 cuchillas lisas desmontables de acero inoxidable de alta calidad.
- Cuerpo en acero inoxidable.
- Pies antideslizantes, aportan estabilidad a la hora del uso.

FR

69581 - Batidora INOX

- Idéal pour préparer tout type de jus, milk-shakes, crèmes, sauces, granités, etc.
- Puissant moteur de 1000 W pour mixer, mélanger et triturer de façon rapide et efficace.
- Contrôle de vitesse variable avec affichage lumineux, sélection de la vitesse souhaitée avec le bouton rotatif.
- Trois fonctions préétablies : Pulse · Ice crush · Smoothie.
- * Vitesse PULSE pour mixer à sa guise à la vitesse maximum.
- * Vitesse ICE CRUSH, fonction spéciale pour piler la glace.
- Bol en verre borosilicate avec graduations (ml / cups / oz) de grande qualité résistant aux rayures de 1,50 L.
- Verre doseur de 50 ml / 1-3 / 4 oz.
- 6 lames lisses démontables en acier inoxydable de grande qualité.
- Corps en acier inoxydable. Pieds antidérapants, qui apportent une stabilité lors de l'utilisation.

EN

69581 - Batidora INOX

- Ideal for making all types of juices, smoothies, creams, sauces, slushies, etc.
- Powerful 1000 W motor to liquefy, mix, and chop quickly and efficiently.
- Variable speed control with illuminated display, select the desired speed using the selector knob.
- Three pre-set functions, Pulse · Ice Crush · Smoothie.
- * PULSE speed to blend foods to desired texture at maximum speed.
- * ICE CRUSH speed, special function for crushing ice.
- High-quality scratch-resistant borosilicate glass pitcher (ml / cups / oz) 1.5 L.
- Measuring cup 50 ml / 1-3/4 oz.
- 6 detachable high quality stainless steel flat blades.
- Stainless steel body. Anti-slip base, provides stability in operation.

69587 - Batidora WHITE

- Ideal para elaborar todo tipo de zumos, batidos, cremas, salsas, granizados, etc.
- Potente motor de 700 W para licuar, mezclar y triturar de manera rápida y eficaz.
- 2 velocidades + Pulse. Seleccione la velocidad deseada con la ruleta.
- Velocidad PULSE para batir al gusto a máxima velocidad.
- Jarra de cristal con escala (ml / cups / oz) de alta calidad resistente a los arañazos de 1,50 L con cierre de seguridad.
- Vaso medidor de 50 ml / 1-3/4 oz.
- 4 cuchillas lisas desmontables de acero inoxidable de alta calidad.
- Pies antideslizantes, aportan estabilidad a la hora del uso.

69587 - Batidora WHITE

- Idéal pour élaborer tous types de jus, smoothies, soupes, sauces, crèmes, granités, etc.
- Puissant moteur de 700 W pour mixer, mélanger et triturer de façon rapide et efficace.
- 2 vitesses + Pulse, sélection de la vitesse souhaitée avec le bouton rotatif.
- Vitesse PULSE pour mixer à la vitesse maximum.
- Bol en verre avec graduation (ml / cups / oz) de grande qualité résistant aux rayures de 1,50 L avec fermeture de sécurité.
- Verre mesureur de 50 ml / 1-3/4 oz.
- 4 lames lisses démontables en acier inoxydable de grande qualité.
- Pieds antidérapants, qui apportent une stabilité lors de l'utilisation.

69587 - Batidora WHITE

- Perfect for making all kinds of juices, shakes, soups, sauces, patés, smoothies, etc.
- Powerful 700 W motor for blending, mixing and grinding quickly and effectively.
- 2 speeds + Pulse, select the speed you want with the dial.
- PULSE speed for beating food as you like at maximum speed.
- High quality 1.5 L scratch resistant glass pitcher with measurements (ml/cups/oz) with safety latch.
- 50 ml / 1 3/4 oz measuring cup.
- 4 high quality stainless steel removable smooth blades.
- Non-slip feet provide stability during use.

Jarra marcada en mililitros, cups y onzas
Jug marked in millilitres, cups and ounces



Inox



Batidora INOX

Mélangeur · Mixer
Blender · Batedor

Ref	€	W	L	U.Venta
69581	156,40	1000	1,50	1

Jarra marcada en mililitros, cups y onzas
Jug marked in millilitres, cups and ounces



Batidora WHITE

Mélangeur · Mixer
Blender · Batedor

Ref	€	W	L	U.Venta
69587	80,00	700	1,50	1

Ref	Tensión/Voltage	Potencia/Power	Velocidad/Speed	Cap./Capacity	Medidor/ Measurer	Cuchillas/Blades	Dimensiones/Sizes	Peso/Weight
69581	220-240 V; 50 Hz	1000 W	11.000 - 16.500 r.p.m.	1,50L (6 cups/48oz)	50 ml	6	20,5x20x41,5 cm	4,00 Kg
69587	220-240 V; 50 Hz	700 W	14.392 - 16.000 r.p.m.	1,50L (6 cups/48oz)	50 ml	6	22x18x40 cm	3,40 Kg



Inox

Batidor VITA

Mixer · Mixer
Blender · Batedora

Ref	€	W	L	U.Venta
69081	85,40	500	1,5	1

Ref	Tensión/Voltage	Potencia/Power	Velocidad/Sppeed	Capacidad/Capacity	Dimensiones/Sizes	Peso/Weight
69081	220-240 V; 50/60 Hz	500 W	10.000 - 12.000 r.p.m.	1,50 L	21x23x40 cm	3,24 Kg

- Función PULSE para batir a su gusto. Mantenga el mando en la posición P para mantener la batidora en marcha.
- Posición 1 para batir a baja revolución, en especial cuando pique hielo o elementos sólidos duros.
- Posición 2 le permite batir a máxima velocidad todo tipo de frutas blandas y líquidos.
- Asegúrese que la batidora esté en la posición 0 antes de extraer y verter el contenido de la jarra.

- Option PULSE pour battre à volonté, maintenez la commande sur la position P pour laissez le batteur en marche.
- Position 1 pour battre à faible révolution, notamment quand vous hachez des glaçons ou des éléments solides durs.
- Position 2 vous permet de battre à vitesse maximale tout type de fruits mous et liquides.
- Assurez-vous que le batteur se trouve en position 0 avant d'extraire et de verser le contenu de la jarra.

- Use the P option to blend as you choose; keep the switch on the P position to keep the blender working.
- 1 position to blend at low speed especially when crushing ice or hard solid items.
- 2 position allows you to blend all types of soft fruits and liquids at maximum speed.
- Ensure the blender is at the 0 position before removing and pouring the contents from the jug.

MÁQUINAS VACÍO

Colección

Professional use

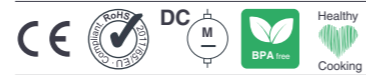

Inox

¿Qué es la cocción al vacío?

Beneficios de la cocción a baja temperatura:

Entre las nuevas técnicas de restauración, la más importante es la cocción y conservación al vacío. Las ventajas que ofrece esta técnica aseguran su introducción y adaptación a las necesidades de cada cocina: ganar tiempo, mejora de costes, mejor organización del personal y mayor duración de los productos, manteniendo sus cualidades higiénicas y organolépticas, son algunas de las principales razones que auguran su éxito e introducción en la restauración.

Hablamos de productos sometidos a un proceso de envasado al vacío y expuestos a temperaturas que nunca superan los 100°C. Debido a la diferencia de presión, conseguimos temperaturas de ebullición del agua a baja temperatura y la penetración de temperatura a corazón de producto es lineal, es decir, no encuentra moléculas de aire y no produce una reacción radial, por lo que el tratamiento y los resultados obtenidos con el producto están perfectamente controlados.

La forma más sencilla de explicar la cocción al vacío es decir que en vez de guisar, como es tradicional, los alimentos a 130°C de calor por un periodo relativamente corto, aquí se cuecen entre 65°C y 99°C en tiempos más prolongados según la naturaleza del género y su peso. Es, pues, una cocción larga y a baja temperatura. En un horno convencional, una pieza de carne se cuece a 200°C de temperatura, lo que ocasiona que el exterior se tueste. Sin embargo, la temperatura en el corazón de la pieza rara vez supera los 50°C. Por lo tanto, sólo es necesaria una temperatura igual o ligeramente superior a los 65°C para cocer un alimento, evitando el resecamiento y el endurecimiento de la fibra muscular así como la sobrecoCCIÓN.

Qu'est-ce que la cuisson sous-vide ?

Avantages de la cuisson à basse température :

Parmi les nouvelles techniques de restauration, la plus importante est la cuisson et la conservation sous-vide. Les avantages qu'offre cette technique garantissent son introduction et son adaptation aux besoins de chaque cuisine : gagner du temps, améliorer les coûts, une meilleure organisation du personnel et une plus grande durée de conservation des produits, en maintenant leur qualités hygiéniques et organoleptiques, sont quelques-unes des raisons principales qui expliquent son succès et son introduction dans la restauration.

Nous parlons de produits soumis à un processus de conditionnement sous-vide et exposés à des températures toujours inférieures à 100°C. En raison de la différence de pression, on obtient des températures d'ébullition de l'eau à basse température et la pénétration de la température au cœur du produit est linéaire, c'est-à-dire qu'elle ne rencontre pas de molécules d'air et ne produit aucune réaction radiale, c'est pourquoi le traitement et les résultats obtenus avec le produit sont parfaitement contrôlés.

La façon la plus simple d'expliquer la cuisson sous-vide est de dire qu'au lieu de cuisiner, comme c'est le cas traditionnellement, les aliments à une température de 130°C pendant un laps de temps relativement court, ils sont ici cuits entre 65°C et 99°C pendant un laps de temps plus long selon la nature du genre et le poids. Il s'agit donc d'une cuisson longue et à basse température. Dans un four conventionnel, une pièce de viande est cuite à une température de 200°C, ce qui provoque le brunissage de l'extérieur. Cependant, la température au cœur de la pièce dépasse rarement 50°C. Par conséquent, il suffit d'une température égale ou légèrement supérieure à 65°C pour cuire un aliment, évitant ainsi le dessèchement et le durcissement de la fibre musculaire ainsi que la surcuisson.

What is Sous Vide?

The benefits of low-temperature cooking

Among the new techniques for cooking professionals, the most important one is cooking and storing food in vacuum sealed pouches. The advantages of the technique mean it will be used in and adapted to the needs of every kitchen. Some of the main reasons why it will be successful and widely used in the hospitality industry are the savings in time and money, better staff organisation and being able to store products longer without sacrificing organoleptic qualities or hygiene.

Sous vide refers to products that are vacuum sealed and never exposed to temperatures above 100° C. Because of the difference in pressure, water boils at a low temperature and heat penetrates into the heart of the product in a linear fashion which means there is no interference from air molecules and a radial reaction does not occur so consequently product manipulation and results can be perfectly controlled.

The simplest way to explain sous vide is to say that instead of the traditional method of cooking food at 130°C for a relatively short time food is cooked at 65°C to 99°C for a longer time, depending on the type of product and how much it weighs. It's essentially slow cooking at a low temperature. In a conventional oven, a piece of meat is cooked at 200°C, which makes the outside brown and crispy. However, the temperature in the centre rarely exceeds 50°C. So you can see that meat only needs to be cooked at 65°C or a little hotter, which prevents it from drying out or getting tough as well as over cooking.

Tabla orientativa · Tableau d'orientation · Guidance table

Almacén Storehouse	25°C +/- 2°C									
Almacenamiento normal Normal storage life										
Sellado al vacío Vacuum sealed life	1-2 semanas 1-2 weeks	3-4 días 3-4 days	2-4 días 2-4 days	1 semana 1 week	5-6 meses 5-6 months					
Frigorífico Fridge	5°C +/- 2°C									
Almacenamiento normal Normal storage life	1-2 semanas 1-2 weeks	1 semana 1 week	1 semana 1 week	3-4 días 3-4 days	2-4 semanas 2-4 weeks	1-2 semanas 1-2 weeks	1-2 semanas 1-2 weeks	1-2 semanas 1-2 weeks	2-3 días 2-3 days	
Sellado al vacío Vacuum sealed life	1 mes 1 month	2-4 semanas 2-4 weeks	2-4 semanas 2-4 weeks	2 semanas 2 weeks	1 mes 1 month	1 mes 1 month	6-12 semanas 6-12 weeks	6-12 semanas 6-12 weeks	1 semana 1 week	
Congelador Freezer	-18°C +/- 2°C									
Almacenamiento normal Normal storage life	6 meses 6 months	6 meses 6 months	6 meses 6 months	1-2 semanas 1-2 weeks	8 meses 8 months	8 meses 8 months	6-12 semanas 6-12 weeks	4 meses 4 months		
Sellado al vacío Vacuum sealed life	2-3 años 2-3 years	2-3 años 2-3 years	2-3 años 2-3 years	2 años 2 years	2-3 años 2-3 years	2-3 años 2-3 years	6 meses 6 months	1 año 1 year		

Altura interior útil 11 cm
11 cm useful interior height



Máquina de vacío campana
Machine sous vide à cloche · Vakuümiergeräte
Bell-shaped vacuum machine · Máquina de vacío tipo cámara

Ref	€	W	U.Venta
69116	1709,70	630	1

Ref	Tensión/Voltage	Potencia/Power	Vacío/Vacuum	Caudal bomba/Pump flow	L. sellado/Seal length	A. sellado/Seal width	Dimensiones/Sizes	Peso/Weight
69116	220-240 V; 50 Hz	630 W	0,9 bar	83 L/min	29 cm	4 cm	42x36x36,5 cm 35x30x5 cm (cámara - chamber)	24,5 Kg

Inox



Máquina de vacío campana
Machine sous vide à cloche · Vakuümiergeräte
Bell-shaped vacuum machine · Máquina de vacío tipo cámara

Ref	€	W	U.Venta
69352	972,30	350	1

Ref	Tensión/Voltage	Potencia/Power	Vacío/Vacuum	Caudal bomba/Pump flow	L. sellado/Seal length	A. sellado/Seal width	Dimensiones/Sizes	Peso/Weight
69352	220-240 V; 50/60 Hz	350 W	0,9 bar	60 L/min	30 cm	2,5 cm	42x38x27 cm 30,5x32,2x8 cm (cámara - chamber)	10 Kg

- Admite la aspiración de líquidos y salsas, sin necesidad de congelarlos antes.
- Envasado por mediación de un COMPRESOR DE AIRE.
- Compresor con pistón, dispone de válvula de entrada y salida de aire.
- Al no ser de aceite no suele precisar mantenimiento alguno.

- Permet l'aspiration de liquides et de sauces, sans avoir à les congeler auparavant.
- Mise sous vide au moyen d'un COMPRESSEUR D'AIR.
- Compresseur avec piston, dispose de valve d'entrée et de sortie d'air.
- Dans la mesure où il n'y a pas d'huile, aucun entretien n'est nécessaire.

- Enables liquids and sauces to be aspirated in the bag with no need to freeze them first.
- U.Ventaaging using an AIR COMPRESSOR.
- Compressor with piston, has an air inlet/outlet valve.
- As it is not oil-based, no maintenance is required.



- Realización de bolsas.
- Admite la aspiración de líquidos y salsas, sin necesidad de congelarlos antes.

- Réalisation de sachets.
- Permet l'aspiration de liquides et de sauces, sans avoir à les congeler auparavant

- Making bags.
- Enables liquids and sauces to be aspirated in the bag with no need to freeze them first.



Bobina incluida
Coil tube included

Accesorios · Accessoires · Accessories



Pestañas para colocar en la máquina de vacío PROFESIONAL
Eyelashes to place in the PROFESSIONAL vacuum machine



Compatible para bobinas hasta:
Compatible for coils up to:
69531 - 30 cm / 69541 - 40 cm

Cuchilla interna deslizante, proporciona un corte limpio y preciso
The internal sliding blade makes a clean and precise cut



SopORTE para rollo
Porte-rouleau · Rollenhalter
Roll holder · Suporte de rolo

Ref	€	L (cm)	U.Venta
69531	24,50	30	1
69541	29,80	40	1

Compatible con la ref.: 69530
Compatible con la ref.: 69540



Grado de protección IP20
IP20 degree of protection

Máquina de vacío PROFESIONAL

Machine sous vide · Vakuuiergerät
Vacuum pack machine · Máquina de vacío

Ref	€	W	L (cm)	U.Venta
A 69530	537,50	700	30	1
B 69540	597,30	650	40	1

- Máquina de envasado al vacío profesional, prestaciones de primer nivel.
- Ideal para preparar Sous vide, marinar platos, almacenar distintos alimentos naturales o cocinados, etc.
- Un buen sellado hermético garantiza el sabor, el valor nutricional, la frescura y la protección de los alimentos, aumentando la vida útil entre 2 y 4 veces más.
- Funcionamiento intuitivo y sencillo.
- Doble bomba de vacío muy potente, garantiza un vacío óptimo.
- Ciclo de envasado totalmente automático.
- Función de sellado continuo.
- Función marinado, muy útil para ahorrar tiempo frente a los marinados convencionales.
- Equipada con una barra de sellado extra ancha de 5 mm.
- Carcasa externa de acero inoxidable, robusta e higiénica.
- Gracias a su asa en la tapa el envasado al vacío será más cómodo.
- Bandeja extraíble para pequeñas cantidades de líquidos.
- Incluye 2 pestañas en su parte posterior para adaptar el soporte para rollo (NO incluido).
- Se apoya en cuatro pies de goma para una mayor estabilidad.

- Machine professionnelle d'emballage sous vide, performances de premier ordre.
- Idéale pour préparer Sous vide, faire mariner des plats, stocker différents aliments naturels ou cuisinés, etc.
- Un bon scellage hermétique garantit le goût, la valeur nutritionnelle, la fraîcheur et la protection des aliments, 2 à 4 fois plus de durée de conservation.
- Fonctionnement simple et intuitif.
- Pompe à vide double très puissante, assure un vide optimal.
- Cycle d'emballage entièrement automatique.
- Fonction de scellage continue.
- Fonction marinade, très utile pour gagner du temps par rapport aux marinades conventionnelles.
- Équipée d'une barre de scellage extra large de 5 mm.
- Carcasse externe robuste et hygiénique en acier inoxydable.
- Grâce à sa poignée sur le couvercle, l'emballage sous vide sera plus pratique.
- Plateau pour petites quantités de liquides amovibles.
- Comprend 2 languettes à l'arrière pour adapter le porte-rouleau (NON inclus).
- Quatre pieds en caoutchouc pour une plus grande stabilité.

- Professional vacuum U.Ventaaging machine, top quality features.
- Ideal to prepare Sous vide, marinate dishes, and store different raw or cooked foods, etc.
- A proper airtight seal guarantees the flavour, nutritional value, freshness, and protection of food extending its useful life between 2 and 4 times.
- Intuitive and simple operation.
- Very powerful dual vacuum pump, guarantees optimal vacuum.
- Fully automatic U.Ventaaging cycle.
- Continuous sealing function.
- Marinate function, very useful to save time compared to conventional marinating.
- Equipped with an extra-wide 5mm sealing bar.
- Sturdy and hygienic stainless steel outer housing.
- The lid handle provides improved comfort for vacuum U.Ventaaging.
- Tray for small amounts of extractable liquids.
- Includes 2 tabs on the back to adapt the support for the roll (NOT included).
- Includes four rubber support bases for greater stability.



Función canister
Canister function



Inox

Ref	Tensión/Voltage	Potencia/Power	Presión/Pressure	Caudal bomba/Pump flow	L. sellado/Seal length	A. sellado/Seal width	Dimensiones/Sizes	Peso/Weight
69530	220-240 V; 50-60 Hz	700 W	0,9 bar	16 L/min (2 pumps)	31 cm	5 mm	39x27,5x13 cm	6,90 Kg
69540	220-240 V; 50-60 Hz	650 W	0,9 bar	16 L/min (2 pumps)	40 cm	5 mm	49x26x12,5 cm	8,50 Kg



Barra para corte instantáneo
Orificio para la aspiración de los botes
Bar for instant cutting
Opening for the sealing of canisters

3 niveles de tiempo de sellado (secos, húmedos...)
Doble bomba de vacío muy potente
Función MARINATE y PULSE
Three levels of sealing time (dry, wet, etc.)
Very powerful dual vacuum pump
MARINATE and PULSE functions

Semiprofessional use

Máquina de vacío EFFICIENT

Machine sous vide · Vakuuiergerät
Vacuum pack machine · Máquina de vacío

Ref	€	W	U.Venta
69353	226,20	130	1

Ref	Tensión/Voltage	Potencia/Power	Presión/Pressure	Caudal bomba/Pump flow	L. sellado/Seal length	A. sellado/Seal width	Dimensiones/Sizes	Peso/Weight
69353	220-240 V; 50 Hz	130 W	0,9 bar	20 L/min (2 pump)	30 cm	2 mm (2)	40x19,4x11 cm	2,90 Kg



Posibilidad de realización de bolsas
Bobina incluida - 22 cm x 3 m
Orificio para la aspiración de los botes
Possibility of making bags
Coil tube included - 22 cm x 3 m
Opening for the sealing of canisters



Máquina de vacío MAXI

Machine sous vide · Vakuuiergerät
Vacuum pack machine · Máquina de vacío

Ref	€	W	U.Venta
69350	150,80	120	1

Ref	Tensión/Voltage	Potencia/Power	Presión/Pressure	Caudal bomba/Pump flow	L. sellado/Seal length	A. sellado/Seal width	Dimensiones/Sizes	Peso/Weight
69350	220-240 V; 50/60 Hz	120 W	0,6 - 0,8 bar	12 l/min	30 cm	3 mm	43,5x21x10 cm	2,05 Kg

Incluye 10 bolsas de vacío (20x30 cm)
Includes 10 vacuum bags (20x30 cm)

Incluye 10 bolsas de vacío: 20x30 cm (5) / 28x40 cm (5)
Includes 10 vacuum bags: 20x30 cm (5) / 28x40 cm (5)



Función canister
Canister function

Máquina de vacío HOME

Machine sous vide · Vakuuiergerät
Vacuum pack machine · Máquina de vacío

Ref	€	W	U.Venta
69050	108,40	110	1



Máquina de vacío LUXE

Machine sous vide · Vakuuiergerät
Vacuum pack machine · Máquina de vacío

Ref	€	W	U.Venta
69151	122,90	120	1

Ref	Tensión/Voltage	Potencia/Power	Presión/Pressure	Caudal bomba/Pump flow	L. sellado/Seal length	Dimensiones/Sizes	Peso/Weight
69050	220-240 V; 50 Hz	110 W	0,8 bar	9 l/min	28 cm (max)	35,7x14,8x8,7 cm	1,40 Kg
69151	220-240 V; 50 Hz	120 W	0,4 - 0,8 bar	9 l/min	30 cm (max)	37x14,4x7,4 cm	1,55 Kg

Ultrarrápido / Ultra-fast:

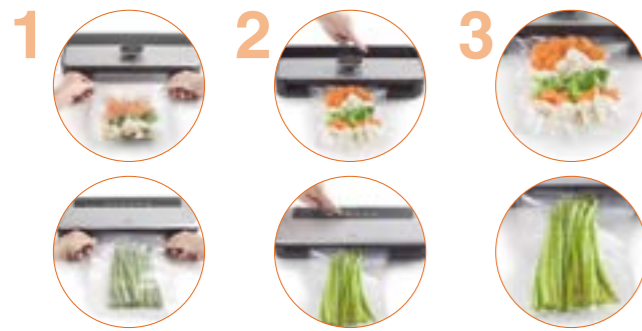

Reduce 6 pasos en 3
Turns 6 steps into 3

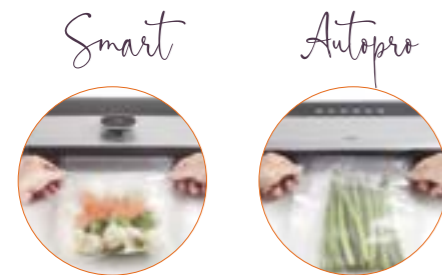

AutoPlace
Garantiza la colocación correcta de la bolsa
Placement correct des sacs garanti
Ensures bags are inserted correctly



Accesorio para función canister
Accessory for canister function



Tapa totalmente extraíble
Totally removable lid



Máquina de vacío SMART
Machine sous vide · Vakuümiergerät
Vacuum pack machine · Máquina de vacío

Ref	€	W	U.Venta
69357	104,00	120	1



Fácil limpieza
Easy cleaning



Máquina de vacío AUTOPRO
Machine sous vide · Vakuümiergerät
Vacuum pack machine · Máquina de vacío

Ref	€	W	U.Venta
69356	96,60	120	1

- Doble bomba de vacío con poder de succión de 5 L/min (69357).
- Doble bomba de vacío con poder de succión de 4,3 L/min (69356).
- Ultra rápido: reduce 6 pasos en 3.
- Potente bomba de vacío de hasta 80kpa que garantiza un nivel de vacío óptimo.
- Sellado 100% automático, tan solo pulsando un botón.
- AutoPlace: garantiza la colocación correcta de la bolsa.
- Garantiza la calidad, frescor y sabor de los alimentos durante mucho más tiempo.
- Diseñada para alimentos crudos y cocinados; pescado, carne, verdura, legumbre, embutido, fruta, frutos secos y cocina a baja temperatura.
- Barra de sellado de bolsa de 30 cm de largo.
- Sellado múltiple: sella varias bolsas simultáneamente.
- Contiene un orificio para la aspiración de los botes.
- Diseño compacto y ligero. Funcionamiento intuitivo y sencillo.
- Tapa extraíble para facilitar la limpieza.
- Incluye: 10 bolsas de vacío (20x30 cm) libres de BPA.

- Double pompe à vide avec une puissance d'aspiration de 5 L/min (69357).
- Double pompe à vide avec une puissance d'aspiration de 4,3 L/min (69356).
- Ultra rapide : réduit 6 étapes en 3.
- Pompe à vide puissante pouvant atteindre 80kpa garantissant un niveau de vide optimal.
- Scellage 100% automatique par simple pression sur un bouton.
- AutoPlace : placement correct des sacs garanti.
- Qualité, fraîcheur et saveur garanties des aliments pendant beaucoup plus longtemps.
- Conçue pour les aliments crus et cuits ; poisson, viande, légumes, légumineuses, saucisses, fruits, fruits secs et cuisson à basse température.
- Barre de scellement de sacs de 30 cm de long.
- Scellage multiple : scelle plusieurs sacs simultanément.
- Contient un trou pour l'aspiration des bocaux.
- Conception compacte et légère. Fonctionnement intuitif et simple.
- Comprend : 10 sacs sous vide (20x30 cm) sans BPA.

- Double vacuum pump with 5 L/min suction power (69357).
- Double vacuum pump with 4,3 L/min suction power (69356).
- Ultra-fast: turns 6 steps into 3.
- Powerful vacuum pump with up to 80 kpa ensures an optimal vacuum.
- 100% automatic sealing with the push of a button.
- AutoPlace: ensures bags are inserted correctly.
- Guarantees the quality, freshness and flavour of food for a lot longer.
- Designed for cooked or raw food: fish, meat, vegetables, legumes, cold cuts, fruit, nuts and low temperature cooking.
- 30 cm long bag sealing bar.
- Multiple sealing: can seal several bags simultaneously.
- It has a hole for doing vacuum in containers.
- Compact and lightweight design Simple and intuitive use.
- Includes: 10 BPA free vacuum bags (20x30 cm).



Compartimento para líquidos
Compartment for liquids



Orificio para la aspiración de los botes
Opening for the sealing of canisters



Máquina de vacío EXTREME

Machine de conditionnement sous vide · Vakuümiergerät
Vacuum machine · Máquina de vacío

Ref	€	W	U.Venta
69355	146,30	110	1

Ref	Tensión/Voltage	Potencia/Power	Presión/Pressure	Cap. bomba/Pump Cap.	L. Sellado/Seal	Dimensiones/Sizes	Peso/Weight
69355	220-240 V; 50 Hz	110 W	0,8 bar	12 L/min	30 cm (W=2,5 mm)	42x9,5x15 cm	1,70 Kg



Tres funciones; sellado de bolsa, función automática y función manual
Three functions; bag sealing, automatic function and manual function

Orificio para la aspiración de los botes
Opening for the sealing of canisters



Máquina de vacío SLIM

Machine sous vide · Vakuümiergerät
Vacuum Upackmachine · Máquina de vacío

Ref	€	W	U.Venta
69354	80,30	80	1

Ref	Tensión/Voltage	Potencia/Power	Presión/Pressure	Caudal bomba/Pump flow	L. sellado/Seal length	A. sellado/Seal width	Dimensiones/Sizes	Peso/Weight
69354	220-240 V; 50 Hz	80 W	0,5 bar	4 L/min (1 pump)	30 cm	2 mm	38,4x9,7x5,7 cm	1,00 Kg

- Sella herméticamente los alimentos aumentando de 3 a 5 veces más su durabilidad.
- Expulsa el aire y la humedad, manteniendo sus sabores y nutrientes.
- Panel de control táctil, 2 niveles de envasado al vacío: alimentos húmedos y secos.
- Bandeja para recoger líquidos en la parte posterior de la máquina.
- Gracias a su diseño vertical ocupa poco espacio.

- Scellage hermétique des aliments, augmentant ainsi de 3 à 5 fois leur durabilité.
- Expulse l'air et l'humidité, en conservant leurs saveurs et leurs nutriments.
- Tableau de contrôle tactile, 2 niveaux de conditionnement sous vide : aliments humides et aliments secs.
- Plateau pour recueillir les liquides dans la partie arrière de la machine.
- Prend moins de place grâce à sa conception verticale.

- Hermetically seals the food, increasing its shelf life by 3 to 5 times.
- Expels air and moisture, maintaining the food's flavours and nutrients.
- Touch control panel, 2 levels of vacuum packaging: moist and dry foods.
- Liquid collection tray on the back of the machine.
- Takes up little space thanks to its vertical design.

Incluye:
5 bolsas de 20x30cm / Bobina de 20cmx2m
Tubo canister de 40 cm de largo
Includes: 5 20x30cm bags / 20cmx2m coil tube
40 cm-long canister hose

- Envasadora al vacío doméstica y compacta, perfecta para uso diario.
- Ideal para el almacenamiento de alimentos a largo plazo, aumentando la vida útil entre 2 y 4 veces más y conservando el sabor, el valor nutricional y la frescura. Perfecta para alimentos crudos y cocinados.
- Funcionamiento intuitivo y sencillo.
- Tres funciones disponibles:
 - * Función de sellado de bolsa.
 - * Función automática, perfecta para conservar alimentos secos y duros (semillas, granos de café, frutos secos, pasta, hortalizas duras, etc.).
 - * Función manual, cuando queremos conservar alimentos frágiles como pescados, frutas, champiñones, pan, bizcochos, etc.
- Contiene un orificio para la aspiración de los botes.

- Scelleuse sous-vide domestique et compacte, parfaite pour une utilisation quotidienne.
- Idéal pour conserver des aliments à long terme, augmente de 2 à 4 fois leur vie utile tout en conservant leur goût, la valeur nutritionnelle et la fraîcheur. Parfaite pour des aliments crus et cuisinés.
- Fonctionnement intuitif et simple.
- Fonctions possibles :
 - * Fonction de soudure de sachet.
 - * Fonction automatique, parfait e pour conserver les aliments secs et durs (graines, grains de café, fruits secs, pâtes, légumes, etc...).
 - * Fonction manuelle, pour garder des aliments plus fragiles comme le poisson, les fruits, des champignons, du pains, des biscuits etc.
- Avec orifice pour aspirer les pots.

- Compact vacuum packing machine, perfect for daily home use.
- Ideal for long-term storage of food, making shelf-life to about 2 to 4 times more while preserving the flavour, nutritional value and freshness. Perfect for raw and cooked foods.
- Intuitive and simple operation.
- There are three functions available:
 - * Bag sealing function.
 - * Automatic, ideal function for preserving dry and hard foods (seeds, coffee beans, nuts, pasta, hard vegetables, etc.).
 - * Manual function, for preserving fragile food like fish, fruits, mushrooms, bread, biscuits... etc.
- A hole for drawing out air from canisters.

VACÍO

Boninas · Bolsas · Botes

Professional use



ES

- Apto para uso alimenticio.
- Recomendada para uso con máquina de vacío de la marca LACOR.
- No se recomienda su reutilización tras el uso con carnes, pescados y otros alimentos deteriorables, tan solo tras el uso en productos secos, legumbres, frutos secos, etc.

FR

- Adaptée au conditionnement de denrées alimentaires.
- Recommandée pour être utilisée avec la machine à emballer sous vide LACOR.
- Son utilisation est déconseillée pour reconditionner de la viande, du poisson et d'autres denrées alimentaires périssables. Elle peut être réutilisée pour reconditionner des fruits secs, des légumes, des fruits secs, etc.

EN

- Suitable for use with food.
- Recommended for use with vacuum Packer of the LACOR brand.
- Not recommended to be reused after use with meats, fish and other fresh foods, only after use with dried products, pulses, nuts, etc.



Bobina tubo vacío

Bobine de tube · Vakuumbbeutel Rollen
Coil tube · Bobina manga

Ref	€	Bobina	Micras	U.Venta
69052	14,10	28cmx5m 22cmx5m	105	1
69057	9,60	14cmx10m	105	6
69059	13,20	22cmx10m	105	1
69058	17,20	28cmx10m	105	1
69451	19,40	40cmx10m	105	1
69259	8,90	28cmx5m	105	1
69458	11,40	28cmx5m	90	1
69459	9,10	22cmx5m	90	6
69462	9,70	28cmx5m 22cmx5m	105	1
69463	8,60	22cmx10m	105	1
69464	10,80	28cmx10m	106	1

Lisas
Flat



Bolsas vacío

Sacs de conservation sous vide · Vakuumbbeutel, 100 Stueck
Vacuum bags · Sacos de vacío

Ref	€	Bolsa	Unidades	Micras	U.Venta
69053	5,10	16x20	25	105	6
69054	8,70	20x30	25	105	6
69055	11,70	24x36	25	105	1
69056	14,70	28x40	25	105	1
69042	32,20	20x30	100	105	1
69046	47,00	25x35	100	105	1
69047	64,00	30x40	100	105	1
69048	128,50	40x60	100	105	1
69453	6,00	16x20	25	90	6
69454	11,00	20x30	25	90	1
69455	15,40	24x36	25	90	1
69460	5,60	20x30	25	105	1
69461	10,10	28x40	25	105	1

Lisas
Flat



Ideal para embutidos
Ideal for sausages



Bobina tubo vacío

Bobine de tube · Vakuumbbeutel Rollen
Coil tube · Bobina manga

Ref	€	Bobina	Micras	U.Venta
69452	6,00	12cmx10m	105	6

SAN Plastic
Contenedor
Container

PP Polypropilene
Tapa / Lid



Set 3 botes vacío hogar + adaptador

3 boîte sous vide + Adaptateur · 3 Vakuumb-Behälter-Set + Adapter
3 Shape canister set + Adapter · Conj. 3 caixas vácuo domésticas + Adaptador

Ref	€	L	U.Venta
69051	36,30	0,7-1,4-2,0	1

Máquina de vacío / Vacuum Pack machine

Model	69354	69355	69356	69357	69151	69050	69350	69353	69540	69530	69352	69116
ROLLO · COIL TUBE	✓	✓	✓	✓	✓	✓	✓	✓	✓	✓	✓	✓
BOLSAS · BAGS	✓	✓	✓	✓	✓	✓	✓	✓	✓	✓	✓	✓
BOBINA EMBUTIDOS COIL TUBE FOR SAUSAGES	✓	✓	✓	✓	✓	✓	✓	✓	✓	✓	✓	✓
SET 3 BOTES VACÍO 3 SHAPE CANISTER SET	✓	✓	✓	✓	✓	✓	✓	✓	✓	✓	✓	✓

(*) Apta para la máquina de vacío 69040 (descatalogada)

■ Bolsas y rollos para uso exclusivo del SOUS VIDE

SOUS VIDE

Colección

Household use



ES

- Técnica culinaria que prima la calidad del producto.
- Resultados sorprendentes; alimentos más jugosos, tiernos y succulentos.
- Preserva las cualidades del producto y realza su sabor y textura.

FR

- Technique culinaire qui privilégie la qualité du produit.
- Résultats surprenants ; aliments plus juteux, tendres et succulents.
- Préserve les qualités du produit et améliore sa saveur et sa texture.

EN

- Culinary technique that enhances the quality of the product.
- Amazing results; juicier, more tender and more succulent food.
- Preserves the qualities of the product and enhances its flavour and texture.



Cocinando paso a paso...



Sazonamos los alimentos a cocinar
Assaisonner les aliments à cuisiner
Season the ingredients for cooking



Envasamos al vacío los alimentos
Conditionner les aliments sous vide
Vacuum Pack the ingredients



Llenamos una olla con agua
Remplir une marmite d'eau
Fill a cooking pot with water



Programamos el tiempo y la temperatura
Programmer la durée et la température
Programme in the time and the temperature

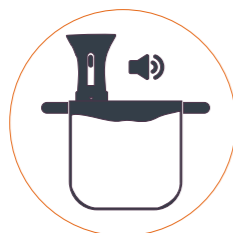

Esperamos a que emita un pitido
Attendre l'émission d'un signal sonore
Wait for the beep



Introducimos la bolsa dentro de la olla
Introduire le sachet dans la marmite
Place the bag into the pot



Retiramos la bolsa y ¡A disfrutar!
Retirer le sachet et, bonne dégustation!
Appetit!
Remove the bag and... Enjoy!

SOUS VIDE	CIRCULACIÓN CIRCULATION	CAUDAL BOMBA PUMP FLOW	VOLUMEN (máx) VOLUME (max)	POTENCIA POWER	TEMPERATURA TEMPERATURE	DESVIACIÓN DESVIATION	ALT. MIN. DE AGUA MIN. WATER HEIGHT
 69192	BOMBA PUMP	6 L/min	40 L	1500 W	5°C - 99°C	0,1°C	12 cm
 69304	BOMBA PUMP	4,5 L/min	30 L	1200 W	5°C - 99°C	0,1°C	11 cm
 69302 - 69303	EJE VENTILADOR FAN SHAFT	N/A	15 L	1200 W	20°C - 90°C	1°C	6 cm

Características de nuestros SOUS VIDE portátiles:

Resistencia de calentamiento: Elemento encargado de calentar el agua. Cuanto mayor es la potencia de la resistencia, mayor es la capacidad de calentamiento del agua y menor el tiempo de espera hasta alcanzar la temperatura programable.

Estabilidad de la temperatura: Cuanto mayor sea la capacidad de la bomba (L/min), mayor será la estabilidad de la temperatura en el recipiente.

Resolución: Escalado de la temperatura a la que se puede programar el agua.

Desviación de la temperatura: La máxima diferencia entre temperatura programada y la temperatura del agua.

Grado de protección contra el agua: Grado de protección IPX7 frente a inmersiones temporales en agua. Esto garantiza que el aparato acepta la inmersión a 1 metro de profundidad durante 30 minutos sin que sea un peligro ni para el propio artículo ni para el usuario.

Caractéristiques de nos SOUS VIDE portables :

Résistance de chauffe : Élément chargé de chauffer l'eau. Plus la puissance de la résistance est importante, plus la capacité de chauffe de l'eau est grande et moins le temps d'attente pour atteindre la température programmable est long.

Stabilité de la température : Plus la capacité de la pompe est grande (L/min), plus la stabilité de la température dans le récipient sera importante.

Résolution : Progression de la température à laquelle peut être programmée l'eau.

Écart de la température : La différence maximale entre la température programmée et la température de l'eau.

Degré de résistance à l'eau : Degré de protection IPX7 face à des immersions temporaires dans l'eau. Cela garantit que l'appareil est étanche à 1 mètre de profondeur pendant 30 minutes sans que cela ne représente un danger ni pour l'appareil ni pour l'utilisateur.

Merkmale unserer tragbaren Vakuumgarer:

Heizwiderstand: Erhitzt das Wasser. Je größer die Widerstandsleistung desto größer ist die Heizkapazität und desto kürzer die Wartezeit, bis die voreingestellte Temperatur erreicht wird.

Temperaturkonstanz: Je größer die Pumpenkapazität (l/min) desto höher ist die Temperaturkonstanz im Behälter.

Skalierung: Temperaturskala für die mögliche Voreinstellung der Wassertemperatur.

Temperaturabweichung: Die maximale Differenz zwischen voreingestellter Temperatur und Wassertemperatur.

Wasserschutzklasse: Schutzklasse IPX7 gegen Eindringen von Wasser beim kompletten Eintauchen für begrenzte Zeit. D. h. das Gerät lässt sich sicher für 30 Minuten 1 Meter tief eintauchen, ohne dass dadurch für den Anwender oder das Gerät eine Gefahr besteht.

Characteristics of our portable SOUS VIDE:

Heating element: Component that heats the water The greater the power of the heating element the greater capacity it has for heating water and the less time you have to wait for the water to reach the programmable temperature.

Temperature stability: The greater the capacity of the pump (L/m) the better the temperature stability in the container.

Resolution: Scale of the temperatures the water can be programmed to.

Temperature variation: The maximum difference between the programmed temperature and the water temperature.

Level of waterproofing protection: IPX7 level protection against temporary immersion in water. This guarantees that the device can withstand being immersed 1 metre deep for 30 minutes with no risk to the device or the user.

Características dos nossos SOUS VIDE portáteis:

Resistência de aquecimento: Elemento destinado a aquecer a água. Quando maior for a potência da resistência, maior a capacidade de aquecimento da água, e menor o tempo de espera até alcançar a temperatura programável.

Estabilidade da temperatura: Quando maior for a capacidade da bomba (litros/min), maior a estabilidade da temperatura no recipiente.

Resolução: Escala de temperatura segundo a qual se pode programar a temperatura da água.

Desvio da temperatura: Diferença máxima entre a temperatura programada e a temperatura da água.

Grado de proteção contra a água: Grado de proteção IPX7 contra a imersão temporária em água, que garante que o aparelho suporta a imersão a 1 metro de profundidade durante 30 minutos sem que tal represente qualquer perigo para o aparelho ou para o utilizador.



Protection Against Temporary immersion



Sous Vide PRO

Sous Vide · Sous Vide
Sous Vide · Sous Vide

Ref	€	W	U.Venta
69192	467,10	1500	1

Nutrientes 100 % Nutrient



Professional use



La circulación mejora y garantiza una distribución uniforme del agua y la estabilidad de la temperatura
Anclaje sencillo y fácilmente almacenable y transportable. Se sujeta a cualquier tipo de olla, cazuela o cubeta que pueda contener 40 L

Circulation improves and ensures uniform water distribution and temperature stability
Simple fastening and easy to store and transport. It is attached to any type of pot, saucepan or tray that can contain 40 L

Rejilla divisoria de bolsas vacío
Grifo de vaciado
Borde silicona para cierre hermético (TAPA)
Split grill for separating bags
Drainage tap
Silicone edge for hermetic closure (LID)

Nutrientes 100 % Nutrient



Professional use

- Cocina alimentos envasados al vacío a baja temperatura.
- Alimentos más tiernos, sabrosos y con la mejor textura.
- Resultados de alta calidad.
- Carcasa robusta fabricada íntegramente en acero inoxidable.
- Cierre hermético gracias a la tapa con borde de silicona.
- Incluye rejilla divisoria para la separación de las bolsas.
- Pantalla digital de tiempo y temperatura.
- Termostato de gran precisión ajustable: 30°C - 95°C (0,1 °C).
- Temporizador ajustable: 99 horas. 6 memorias. Capacidad: 17 litros.
- Filtro de seguridad para evitar impurezas en el sistema de recirculación del agua.
- Incorpora grifo de vaciado.

- Cuisine des aliments emballés sous vide à basse température.
- Des aliments plus tendres, plus savoureux et avec la meilleure texture.
- Résultats de haute qualité.
- Boîtier robuste entièrement fabriqué en acier inoxydable.
- Fermeture hermétique grâce au couvercle avec des bords en silicone.
- Inclut une grille de séparation des sacs.
- Écran numérique pour afficher le temps et la température.
- Thermostat réglable de haute précision : 30°C - 95°C (0,1 °C).
- Minuterie réglable : 99 heures. 6 mémoires. Capacité : 17 litres.
- Filtre de sécurité pour éviter les impuretés dans le système de recirculation de l'eau.
- Incorpore un robinet de vidange.

- Cooks vacuum packaged food at a low temperature.
- More tender, flavourful food with a better texture.
- High quality results.
- The robust body is made entirely of stainless steel.
- The lid with a silicone edge provides a hermetic closure.
- Split grill for separating bags included.
- Digital time and temperature screen.
- High precision adjustable thermostat: 30°C - 95°C (0.1 °C).
- Adjustable timer: 99 hours. 6 memories. Capacity: 17 litres.
- Safety filter for preventing contamination of the water recirculation system.
- Built in drainage tap.



Protection Against Temporary immersion

Nutrientes 100 % Nutrient



Sous Vide PRECISE

Sous Vide · Sous Vide
Sous Vide · Sous Vide

Ref	€	W	U.Venta
69304	310,50	1200	1

Semiprofessional use



La circulación mejora y garantiza una distribución uniforme del agua y la estabilidad de la temperatura
Anclaje sencillo y fácilmente almacenable y transportable. Se sujeta a cualquier tipo de olla, cazuela o cubeta que pueda contener 30 L

Circulation improves and ensures uniform water distribution and temperature stability
Simple fastening and easy to store and transport. It is attached to any type of pot, saucepan or tray that can contain 30 L

Cocedor Sous Vide

Cuiseur Sous Vide · Sous-Vide-Kochapparat
Sous Vide cooker · Máquina de cozinhar a vácuua Sous Vide

Ref	€	W	L	U.Venta
69492	710,30	1600	17	1

Ref	Tensión/Voltage	Potencia/Power	Caudal bomba/Pump flow	Temperat./Temp.	Precisión/Precision	Capacidad/Cap.	Dimensiones/Sizes	Peso/Weight
69492	220-240 V; 50/60 Hz	1600 W	4 L/min	30°C - 95°C	0,1°C	17 L	62,5x36x30 cm	12 Kg

Pantalla táctil: tiempo, temperatura, inicio y stop
Touch screen: time, temperature, start and stop

Nutrientes 100 % Nutrient



Semiprofessional use

- Se emplean bolsas herméticas que se sumergen en el agua caliente por debajo del punto de ebullición.
- Pantalla táctil: tiempo, temperatura, inicio y stop.

- Des sachets hermétiques sont utilisés pour immerger les aliments dans l'eau chaude en-deçà du point d'ébullition, soit environ.
- Écran tactile : heure, température, start et stop.

- Uses hermetically sealed bags that are submerged into hot water below boiling point.
- Touch screen: time, temperature, start and stop.



Sous Vide con tapa

Sous Vide avec couvercle · Sous Vide mit Deckel
Sous Vide with lid · Sous Vide com tampa

Ref	€	W	L	U.Venta
69193	728,70	620	11 - 12,5	1

Ref	Tensión/Voltage	Potencia/Power	Caudal bomba/Pump flow	Temperat./Temp.	Precisión/Precision	Capacidad/Cap.	Dimensiones/Sizes	Peso/Weight
69193	220-240 V; 50/60 Hz	620 W	6 L/min	5 - 99°C	0,1°C	11 -12,5 L	27x29x42 cm	6,30 Kg



Protection Against Temporary immersion

Nutrientes 100 % Nutrient



Sous Vide GOURMET

Sous Vide · Sous Vide
Sous Vide · Sous Vide

Ref	€	W	U.Venta
A 69302	205,20	1200	1
B 69303	205,20	1200	1

Household use



La circulación mejora y garantiza una distribución uniforme del agua y la estabilidad de la temperatura
Anclaje sencillo y fácilmente almacenable y transportable. Se sujeta a cualquier tipo de olla, cazuela o cubeta que pueda contener 15 L

Circulation improves and ensures uniform water distribution and temperature stability
Simple fastening and easy to store and transport. It is attached to any type of pot, saucepan or tray that can contain 15 L

Ref	Tensión/Voltage	Potencia/Power	Temperature/Temp.	Capacidad/Capacity	Dimensiones/Sizes	Peso/Weight
69302	220-240 V; 50/60 Hz	1200 W	20-90°C (0,5°C)	15 L	Ø10x37 cm	1,0 Kg
69303	220-240 V; 50/60 Hz	1200 W	20-90°C (0,5°C)	15 L	Ø10x37 cm	1,0 Kg

SOUS VIDE

Bolas aislamiento

Professional use

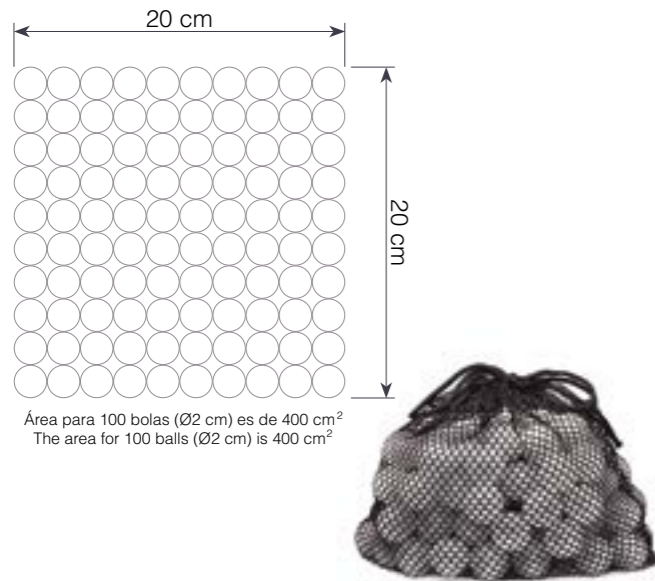

- Bolas aislantes huecas y flotantes de polipropileno (PP), libres de BPA, para dispositivos sous-vide.
- Crean una capa de aislamiento evitando la pérdida de calor en un 75% y en un 90% la evaporación del agua.
- Permiten hervir agua durante horas sin tener que echar más, gracias al mínimo contacto entre agua y aire.
- Aumentan la precisión de la temperatura y ayudan a mantener los envasados al vacío bajo el agua.
- Reducen humos y riesgos de salpicaduras.
- Soportan hasta 150°C sin ningún problema.
- Compatibles con recipientes de todas las formas y tamaños.
- Se presenta con una práctica malla con cierre de cordón.

- Hollow, floating, BPA-free polypropylene (PP) insulation balls for sous-vidé devices.
- Create an insulation layer reducing heat loss by 75% and water evaporation by 90%.
- Enable you to boil water for hours without having to add more, thanks to the minimal contact between water and air.
- Increase temperature accuracy and help keep vacuum packs submerged.
- Reduce smoke and the risk of splashes.
- Withstand up to 150°C without any problem.
- Compatible with containers of all shapes and sizes.
- Come with a handy mesh drawstring bag.

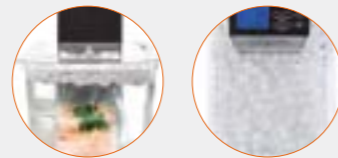

Perfecta capa de aislamiento
Perfect insulation layer

Bolas aislantes para Sous Vide

Billes isolantes p/appareils de conditionnement Sous-Vide · Isolationskugeln
Sous Vide Insulation Balls · Esferas aislantes para Sous Vide

Ref	€	Ø (cm)	Unidad	U.Venta
69219	28,20	2,0	100	1

SOUS VIDE

Rejilla

Professional use

Inox
18/10



4
Bolsas
Bags

- Su diseño es ideal para la sujeción en vertical de 4 bolsas de vacío.
- Evita que las bolsas floten y entren en contacto con las paredes o fondo de las cubetas.
- Permite la circulación del agua entre las bolsas en todo momento, consiguiendo una cocción uniforme.
- Agiliza introducir y retirar las bolsas con facilidad.

- Sa forme est idéale pour faire tenir à la verticale 4 sachets pour sous vide.
- Évite que les sachets flottent et entrent en contact avec les parois ou le fond des cuves.
- Permet la circulation constante de l'eau entre les sachets, obtenant ainsi une cuisson uniforme.
- Permet d'introduire et de retirer les sachets plus facilement et rapidement.

- Its design is ideal for holding 4 vacuum bags vertically.
- Prevents bags from floating and coming into contact with the sides or bottom of the container.
- Enables water to flow between the bags at all times, resulting in even cooking.
- Makes it quicker and easier to insert and remove the bags.

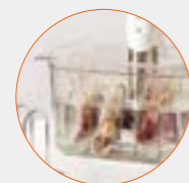

Rack para Sous Vide

Rack pour Sous Vide · Rack für Sous Vide
Rack for sous vide · Cremalheira para sous Vide

Ref	€	cm	Ø Varilla (mm)	U.Venta
67051	16,10	20x13,5x13,5	4	1

SACACORCHOS

Colección

Semiprofessional use



ES

- Diseño elegante, moderno y ergonómico: ideal para su uso profesional y de hogar.
- Funcionamiento rápido y sencillo tan solo pulsando un botón.
- Facilita la extracción del corcho de cualquier botella de vino en tan solo 6-8 segundos.
- Extrae el corcho suavemente y de forma silenciosa.
- Cabecial de extracción con iluminación led (63056 / 63057).
- Indicador de batería luminoso mediante LED: 4 niveles para indicar el nivel de energía (63056).
- Se carga mediante cable Micro USB.
- Incluye: cable cargador USB y descapsulador.

FR

- Style élégant, moderne et ergonomique : idéal pour une utilisation aussi bien professionnelle que domestique.
- Fonctionnement rapide et simple en appuyant simplement sur un bouton.
- Facilite l'extraction du bouchon en liège de n'importe quelle bouteille de vin en 6-8 secondes seulement.
- Extraie le bouchon en liège lentement et silencieusement.
- Tête d'extraction avec éclairage led (63056 / 63057).
- Indicateur de batterie lumineux via LED : 4 niveaux pour indiquer le niveau de batterie (63056).
- Se charge à l'aide d'un câble Micro USB.
- Inclut : câble chargeur USB et décapsuleur.

EN

- Smart, modern and ergonomic design - ideal for professional and home use.
- Quick and easy push-button operation.
- Removes the cork from any bottle of wine in just 6-8 seconds.
- Removes the cork gently and quietly.
- Extraction head with led lighting (63056 / 63057).
- Battery indicator led: 4 energy level indicators (63056).
- Charging by Micro USB cable.
- Included: USB charger and decapsulator.



Autonomía
Battery life
30-40
Botellas
Bottles

Sacacorchos BLACK LUXE

Tire-bouchon · Korkenzieher
Corkscrew · Saca-rolhas

Ref	€	Ø (cm)	h (cm)	U.Venta
63056	38,30	4,8	22	1



Autonomía
Battery life
30-40
Botellas
Bottles

Sacacorchos BLACK

Tire-bouchon · Korkenzieher
Corkscrew · Saca-rolhas

Ref	€	Ø (cm)	h (cm)	U.Venta
63057	29,60	5	19	1



Autonomía
Battery life
30
Botellas
Bottles

Sacacorchos eléctrico AutoPro

Tire bouchon électrique · Korkenzieher, elektrisch
Electric corkscrew · Saca-rolhas Eléctrico

Ref	€	W	cm	U.Venta
63031	40,70	1,2	Ø12x32	1



Autonomía
Battery life
30-40
Botellas
Bottles



Sacacorchos eléctrico SMART

Tire bouchon électrique · Korkenzieher, elektrisch
Electric corkscrew · Saca-rolhas Eléctrico

Ref	€	W	cm	U.Venta
63054	43,70	18	Ø5x25	1

TERMOELÉCTRICOS

Armarios refrigeradores

· Semiprofessional use ·

CE



ES

- Diseñados para refrigerar eficazmente botellas de vino y otras bebidas.
- La temperatura interior puede ser ajustada mediante el control electrónico.
- Puerta con cámara de cristal templado y sistema de apertura con tirador.
- Estantes extraíbles.
- Silencioso y sistema antivibratorio.
- Pies regulables en altura.
- **NOTA:** deje suficiente espacio en la parte trasera (mínimo 5 cm) para permitir la salida del calor y una adecuada ventilación.
- Vinoteca termoelectrónica: el control y regulación de la temperatura dependerá de la temperatura ambiental del establecimiento.

FR

- Conçue pour refroidir efficacement les bouteilles de vin et autre boissons.
- La température intérieure peut être réglée à l'aide du contrôle électronique.
- Porte en verre trempé et système d'ouverture avec poignée.
- Étagères extractibles.
- Silencieuse et système anti-vibrations.
- Pieds réglables en hauteur.
- REMARQUE : laissez suffisamment d'espace dans la partie arrière (minimum 5 cm) pour permettre la sortie de la chaleur et une bonne ventilation.
- **Cave à vin thermoélectrique :** le contrôle et le réglage de la température dépendront de la température ambiante de l'établissement.

EN

- Designed to effectively cool bottles of wine and other beverages.
- The internal temperature can be adjusted using the electronic control.
- Door with tempered glass chamber and handle-operated opening system.
- Pull-out shelves.
- Silent, anti-vibration system.
- Height-adjustable legs.
- NOTE: leave enough space at the back (minimum 5 cm) to allow heat to escape and adequate ventilation.
- **Thermoelectric wine cooler:** the temperature control and regulation depends on the ambient temperature of the location.

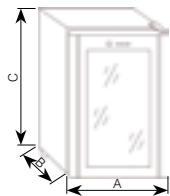

Armarios refrigeradores

Refridisseur à vin · Thermo Weinkühler
Thermo wine cooler · Armário refrigerador

Ref	€	W	Botellas	U.Venta
A 69670	385,60	70	8	1
B 69671	413,90	70	12	1
C 69672	459,50	70	18	1
D 69673	516,30	70	28	1

Ref	Tensión/Voltage	Botellas/Bottles	Potencia/Power	Capacidad/Cap.	Temperature/Temp.	Consumo/Consump.	Dimensiones/Sizes A x B x C	Peso/Weight
69670	220-240 V; 50 Hz	8	70 W	23 L	11 - 18°C	190 kWh/annum	26x49,5x48 cm	10,0 Kg
69671	220-240 V; 50 Hz	12	70 W	31 L	11 - 18°C	129 kWh/annum	34,5x48x47 cm	13,0Kg
69672	220-240 V; 50 Hz	18	70 W	50 L	11 - 18°C	146 kWh/annum	34,5x49x67 cm	17,0 Kg
69673	220-240 V; 50 Hz	28	70 W	71 L	11 - 18°C	179 kWh/annum	45x52x72,5 cm	24,3 Kg

MERLOT

Armarios con compresor

· Semiprofessional use ·

CE

ES

- Armario refrigerador con sistema de enfriamiento por compresor.
- Diseñados para refrigerar eficazmente botellas de vino y otras bebidas.
- La temperatura interior puede ser ajustada mediante el control electrónico.
- Acabado en acero inoxidable y cristal negro.
- Puerta con cámara de cristal templado y sistema de apertura con tirador.
- Estantes extraíbles acabados en madera.
- Silencioso y sistema antivibratorio.
- Pies regulables en altura.
- **NOTA:** deje suficiente espacio en la parte trasera (mínimo 5 cm) para permitir la salida del calor y una adecuada ventilación.

FR

- Cave à vin avec système de refroidissement par compresseur.
- Conçue pour refroidir efficacement les bouteilles de vin et autre boissons.
- La température intérieure peut être réglée à l'aide du contrôle électronique.
- Finitions en acier inoxydable et verre noir.
- Porte avec chambre en verre trempé et système d'ouverture avec poignée.
- Étagères extractibles avec finition en bois.
- Silencieuse et système anti-vibrations.
- Pieds réglables en hauteur.
- **REMARQUE:** laissez suffisamment d'espace dans la partie arrière (minimum 5 cm) pour permettre la sortie de la chaleur et une bonne ventilation.

EN

- Refrigerated cabinet with compressor cooling system.
- Designed to effectively cool bottles of wine and other beverages.
- The internal temperature can be adjusted using the electronic control.
- Stainless steel and black crystal finish.
- Door with tempered glass chamber and handle-operated opening system.
- Wood finish pull-out shelves.
- Silent, anti-vibration system.
- Height-adjustable legs.
- **NOTE:** leave enough space at the back (minimum 5 cm) to allow heat to escape and adequate ventilation.



Display luminoso de control de temperatura digital
Luminous digital temperature control display



Armario refrigerador de compresor

Refridisseur à vin à compresseur · Weinkühler mit Kompressor
Compressor type wine cooler · Refrigerador de vinho do tipo compresso

Ref	€	W	Botellas	U.Venta
A 69700	519,60	85	12	1
B 69701	534,80	85	12	1
C 69702	828,50	85	18	1
D 69239	437,20	85	18	1
E 69238	466,20	85	28	1
F 69703	833,90	85	51	1

Ref	Tensión/Voltage	Botellas/Bottles	Potencia/Power	Temperatura Temp.	Consumo Consump.	Ruido Noise	Refrigerante Refrigerant	Dimensiones/Sizes	Peso/Weight
69700	220-240 V ; 50/60 Hz	12	85 W	5°C-18°C	107 kWh/annum	45 dB	R600A	44x47x53 cm	18,0 Kg
69701	220-240 V ; 50/60 Hz	12	85 W	5°C-18°C	136 kWh/annum	45 dB	R600A	25x45x79 cm	17,0 Kg
69702	220-240 V ; 50/60 Hz	18	85 W	5°C-18°C	145 kWh/annum	46 dB	R600A	34,5x48x83 cm	22,3 Kg
69239	220-240 V ; 50/60 Hz	18	85 W	5°C-18°C	120 kWh/annum	42 dB	R600A	34,5x45x77 cm	19,5 Kg
69238	220-240 V ; 50/60 Hz	28	85 W	5°C-18°C	189 kWh/annum	42 dB	R600A	43x45x84 cm	24,0 Kg
69703	220-240 V ; 50/60 Hz	51	85 W	5°C-18°C	156 kWh/annum	47 dB	R600A	49,5x56,5x85 cm	34,0 Kg

BAR Refrigeradores

Professional use



Puerta reversible
Reversible door

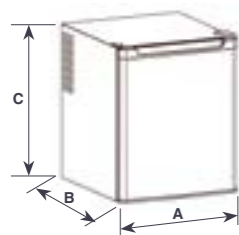

Refrigerador minibar

Mini frigo bar · Minibar Kühlschrank
Mini-bar refrigerator · Refrigerador mini-bar

Ref	€	W	U.Venta
A 69070	256,90	70	1
B 69075	256,90	70	1



No introduzca alimentos o bebidas calientes
Do not introduce hot food or drinks

Ref	Tensión/Voltage	Potencia/Power	Cap./Capac.	Temperatura/Temp.	Consumo/Cons.	Ruido/Noise	Refrig./Rerig.	Dimensiones/Sizes A x B x C	Peso/Weight
69070	220-240 V; 50/60 Hz	70 W	38 L	6°C - 22°C	96 kWh/annum	26dB	R600a (27g)	43x41x51 cm	9,0 Kg
69075	220-240 V; 50/60 Hz	70 W	38 L	6°C - 22°C	96 kWh/annum	26dB	R600a (27g)	43x41x51 cm	9,0 Kg

REFRIGERADOR TERMOELÉCTRICO: el control y regulación de la temperatura, dependerá de la temperatura ambiental del establecimiento
THERMOELECTRIC REFRIGERATOR: temperature control and regulation depend on the ambient temperature of the establishment

MÁQUINAS DE HIELO Colección

Professional use



Perfecta para una producción de grandes volúmenes
Perfect for large volume production

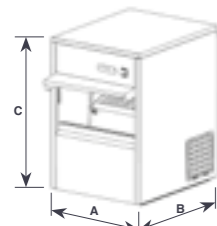

Máquina de hielo PRO

Machine à fabriquer des glaçons · Eiswürfelmaschine
Ice maker · Máquina de hielo

Ref	€	W	U.Venta
69320	1070,00	170	1

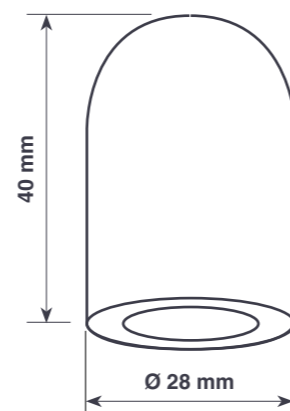

Tamaño y forma cubito hielo
Escala: 1:1
Ice cube size and shape
Scale: 1:1

Ref	Tensión/Voltage	Potencia/Power	Cap. contenedor hielo Ice container cap.	Producción/Product.	Cubo/Ice (Sizes)	Dimensiones/Sizes A x B x C	Peso/Weight
69320	220-240 V; 50 Hz	170 W	4 Kg	>20 Kg/24h	Ø28x40 mm	38x48x59 cm	27 Kg



En 10 o 12 minutos, obtendrá cubitos de hielo
In 10 to 12 minutes you will have ice cubes.



Dispone de programador
It has a programmer

Máquina de hielo ICE

Machine à glaçons · Eiswürfelmaschine
Ice cubes maker · Máquina de fazer gelo

Ref	€	W	L	U.Venta
69314	413,30	150	1,50	1



9 cubitos por ciclo (cada ciclo es de 8 min aproximadamente)
9 cubes per cycle (each cycle is approximately 8 min.)

Ventana transparente
Transparent window



ABS PP

Plastic Polypropilene

Máquina de hielo NORD

Machine à glaçons · Eiswürfelmaschine
Ice cubes maker · Máquina de fazer gelo

Ref	€	W	L	U.Venta
69340	270,10	100	2,20	1

Ref	Tensión/Voltage	Potencia/Power	Capacidad/Capacity	Contenedor/Cont.	Producción/Product.	Dimensiones/Sizes	Peso/Weight
69314	220-240 V; 50/60 Hz	150 W	1,50 L	0,6 Kg	10-15 Kg/24h	32x32x38 cm	11,30 Kg
69340	220-240 V; 50/60 Hz	100 W	2,20 L	0,7 Kg	12 Kg/24h	36x24x33 cm	8,00 Kg

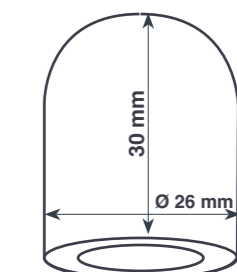

Tamaño y forma cubito hielo
Escala: 1:1
Ice cube size and shape
Scale: 1:1

Household use

- Funcionamiento sencillo; rellena manualmente el depósito de agua y obtén cubitos de hielo en pocos minutos. Sin necesidad de toma de agua.
- Depósito de agua de 1,50 L (69314) / 2,2 L (69340) de capacidad.
- Produce hasta 10 - 15 kg por día (69314).
- Produce hasta 12 kg por día y 9 cubitos en cada ciclo (69340).
- Forma del cubito de hielo: bala (Ø26x30 mm).
- Ciclo de producción totalmente automático y silencioso.
- Detección por infrarrojos, se detendrá automáticamente al detectar el contenedor lleno.
- Alarma acústica cuando el compartimento de hielo está lleno o si se necesitan más agua.
- Incluye pala para la extracción de los cubitos de hielo.
- Drenaje en la base, no requiere instalación o desagüe.

- Fonctionnement simple : remplissez le réservoir d'eau et obtenez des glaçons en quelques minutes. Ne nécessite pas d'évacuation d'eau.
- Réservoir d'eau d'une capacité de 1,50 L (69314) / 2,2 L (69340).
- Produit jusqu'à 10 - 15 kg par jour (69314).
- Produit jusqu'à 12 kg par jour et 9 glaçons à chaque cycle (69340).
- Forme du glaçon : cylindrique (Ø26x30 mm).
- Cycle de production entièrement automatique et silencieux.
- Détection par infra-rouges ; la machine s'arrêtera automatiquement si elle détecte que le conteneur est plein.
- Alarme sonore lorsque le compartiment à glaçons est plein ou lorsqu'il faut remettre de l'eau.
- Inclut une pelle pour prendre les glaçons.
- Drainage à la base, ne requiert pas d'installation spécifique ou de tuyau d'écoulement.

- Easy to use. Fill the water tank manually and get ice cubes in just a few minutes.
- Doesn't need its own plumbing.
- Water tank with 1.50 L (69314) / 2.2 L (69340) capacity.
- Makes up to 10 - 15 kg a day (69314).
- Makes up to 12 kg a day and 9 ice cubes in every cycle (69314).
- Ice cube shape: bullet (Ø 26 x 30 mm).
- Totally automatic and silent production cycle.
- Infrared detection. It stops automatically when it detects a full container.
- It makes a sound when the ice compartment is full or if more water is needed.
- A blade is included for removing the ice cubes.
- The draining in the base does not require installation or a drain.

PICADORAS HIELO

Colección



Compatible con las máquinas de hielo LACOR
Compatible with LACOR ice machines



Picadora de hielo PRO
Broyeur à glace · Eis-Crusher
Ice crusher · Picadora de gelo

Ref	€	W	L	Producción (Kg/h)	U.Venta
69313	113,60	60 - 80	2,80	12	1

Ref	Tensión/Voltage	Potencia/Power	Cap. hielo/Ice cap.	Capacidad/Capacity	Embudo/Funnel	Dimensiones/Sizes	Peso/Weight
69313	220-240 V; 50/60 Hz	60-80 W	12 Kg/h	2,80 L	Ø14 cm	17x29x47,5 cm	11,30 Kg

- Ideal para la preparación de cócteles, combinados, granizados, limonadas, refrescos, postres fríos, etc.
- Una manera simple y rápida de obtener hielo picado en 30 segundos presionando un botón
- Cuerpo de acero inoxidable
- Embudo de llenado superior extraíble de Ø140 mm
- Recipiente de recogida extraíble con una capacidad de 2,80 L
- Anclajes de seguridad en el recipiente de recogida
- Interruptor de encendido/apagado en la parte frontal
- Todas las partes desmontables son aptas para lavavajillas
- 4 patas con ventosas, aporta estabilidad a la hora del uso

- Idéal pour la préparation de cocktails, mélanges, granités, limonades, rafraîchissements, desserts froids, etc.
- Une façon simple et rapide d'obtenir de la glace pilée en 30 secondes, simplement en appuyant sur un bouton
- Corps en acier inoxydable
- Entonnoir de remplissage supérieur extractible de Ø140 mm
- Récipient d'accueil extractible avec une capacité de 2,80 L
- Ancrages de sécurité sur le récipient d'accueil
- Interrupteur de marche/arrêt sur la partie avant
- Toutes les parties démontables sont aptes pour aller au lave-vaisselle
- 4 pieds avec ventouses qui confèrent une stabilité lors de l'utilisation

- Ideal for preparing cocktails, drinks, slushies, lemonade, soft drinks, cold desserts, etc.
- A simple quick way to make crushed ice in 30 seconds by pressing a button
- Stainless steel body Ø140 mm removable top intake cone
- Removable crushed ice container with a capacity of 2.80 L
- Safety anchors on the crushed ice container
- Front On/off switch
- All removable parts are dishwasher safe
- 4 legs with suction cups, provides stability in operation

New



Picadora de hielo ICE
Broyeur à glaçons · Eis-Crusher
Ice crusher · Picadora de gelo

Ref	€	Ø (cm)	h (cm)	U.Venta
69431	496,90	9	22,5	1

- Fabricada en acero inoxidable 18/10 y diseñada para uso profesional.
- Robusto y duradero con un rendimiento excepcional: producción de 90 kg/hora.
- Ideal para preparar hielo para granizados, mojitos y otras bebidas con hielo.
- Microinterruptor de seguridad.
- Funcionamiento automático.
- Recipiente con una capacidad de 3 L.
- Máxima estabilidad gracias a sus 4 pies antideslizantes.

- Fabriqué en acier inoxydable 18/10 et conçu pour un usage professionnel.
- Robuste et durable, avec un rendement exceptionnel : production de 90 kg/heure.
- Idéal pour préparer de la glace pour les granités, les mojitos et autres boissons contenant de la glace pilée.
- Micro-interrupteur de sécurité.
- Fonctionnement automatique.
- Récipient avec une capacité de 3 L.
- Stabilité maximale grâce à ses 4 pieds antidérapants.

- Made of 18/10 stainless steel and designed for professional use.
- Robust and long-lasting with exceptional performance: 90 kg/hour production.
- It's perfect for preparing ice for shaved ice, mojitos and other iced drinks.
- Safety micro-switch.
- Automatic operation.
- Container with 3L capacity.
- Maximum stability because of the 4 non-slip feet.

Ref	Tensión/Voltage	Potencia/Power	Velocidad/Speeds	Producción/Produt.	Capacidad/Capacity	Dimensiones/Sizes	Peso/Weight
69431	220-240 V; 50-60 Hz	200 W	1000 r.p.m.	90 Kg/h	3,00	32,9x18,7x53,3 cm	5,48 Kg



Picadora de hielo MARBLE
Broyeur à glaçons · Eis-Crusher
Ice crusher · Picadora de gelo

Ref	€	W	L	U.Venta
69310	85,90	100	0,50	1

Ref	Tensión/Voltage	Potencia/Power	Cap. hielo/Ice cap.	Capacidad/Capacity	Embudo/Funnel	Dimensiones/Sizes	Peso/Weight
69310	220-240 V; 50/60 Hz	100 W (5.500 r.p.m.)	-	0,50 L	-	18x20,5x46,5 cm	5,10 Kg
69313	220-240 V; 50/60 Hz	60-80 W	12 Kg/h	2,80 L	Ø14 cm	17x29x47,5 cm	11,30 Kg

- Ideal para la preparación de cócteles, combinados, granizados, limonadas, refrescos, postres fríos, etc.
- Una manera simple y rápida de obtener hielo picado en 30 segundos presionando un botón.
- Cuchillas de acero inoxidable.
- Interruptor de encendido/apagado.
- Todas las partes desmontables son aptas para lavavajillas.

- Idéal pour la préparation de cocktails, mélanges, granités, limonades, rafraîchissements, desserts froids, etc.
- Une façon simple et rapide d'obtenir de la glace pilée en 30 secondes, simplement en appuyant sur un bouton.
- Lames en acier inoxydable.
- Interrupteur de marche/arrêt.
- Toutes les parties démontables sont aptes pour aller au lave-vaisselle.

- Ideal for preparing cocktails, drinks, slushies, lemonade, soft drinks, cold desserts, etc.
- A simple quick way to make crushed ice in 30 seconds by pressing a button.
- Stainless steel blades.
- Front On/off switch.
- All removable parts are dishwasher safe.

FREEZE

Máquina enfriacopas

Professional use



- Gracias a su diseño, la FREEZE es perfecta para cualquier local ya que se adapta a todo tipo de superficies, ocupando el mínimo espacio.
- Se puede ubicar donde se precise según las necesidades de cada ocasión.
- Perfecta para negocios de mucha actividad.
- Fabricado en acero inoxidable.
- Conexión a botella de CO₂ de 28 ó 36 Kg.
- Contador de operaciones.
- Luces tipo LED de activación por impulsos de gas.
- Sistema de conexión a botella con sistema de seguridad incluido.

- Thanks to its design, the FREEZE is perfect for any local adapts to all types of surfaces, taking up a minimum of space.
- Can be placed where required according to the needs of each occasion.
- Perfect for busy business.
- Made of steel stainless.
- Connection to CO₂ bottle of 28 or 36 Kg.
- Counter operations.
- Lights activation type LED by impulses from gas.
- Bottle with safety system including system.

Precios NO sujetos al sistema de descuentos habitual de LACOR
 Prix non soumis au système habituel de remises de LACOR
 Prices not subject to the usual discount system of LACOR

Máquina enfriacopas FREEZE

Machine à givrer les verres · Gläser-Kühlmaschine
 Glass cooler machine · Máquina para enfriar copas

Ref	€	W	U.Venta
69300	3155,00	25	1

Ref	Tensión/Voltage	Potencia/Power	Programas/Program.	Dimensiones/Sizes	Peso/Weight
69300	220-240 V; 50/60 Hz	25 W	4	22,8x30,5x 50 cm	12 Kg

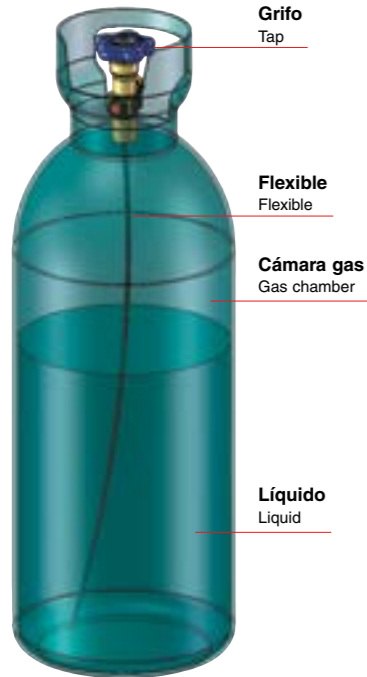

¿Qué tipo de gas utilizamos?

El gas que utilizan nuestras máquinas es Gas carbónico alimentario en estado líquido. El Dióxido de Carbono, también denominado óxido de carbono (IV), gas carbónico y anhídrido carbónico, CO₂, es insípido, incoloro, inodoro y no inflamable.

Aunque la forma más común en que se encuentra el CO₂ es en estado gaseoso, bajo determinadas condiciones se puede encontrar también en estado líquido o sólido. Estas botellas están destinadas para uso médico y alimentario y lo que las diferencia del resto es que en su interior cuenta con una sonda que extrae el líquido criogénico que al liberarse alcanza una temperatura de -79,8 °C

Seguridad LACOR

- 1.- Funcionamiento a base de gas carbónico líquido alimentario
- 2.- Control de presión de gas. Control de temperatura de congelación del gas ajustable de -8 a -55°C
- 3.- Fabricado en Acero Inoxidable de uso médico y alimentario. Todos los conductos interiores están fabricados en AISI-316 garantizando las óptimas condiciones alimentarias e higiénico-sanitarias
- 4.- Adaptable a cualquier tamaño de copa o vaso
- 5.- Exclusivo sistema de seguridad patentado y control para presiones superiores a 100 bar

Nuestros artículos cumplen las siguientes normativas:

- 1.- Directiva 2006/95/CE de seguridad eléctrica
- 2.- Directiva 2006/108/CE de compatibilidad electromagnética
- 3.- Directiva 2006/42/CE de máquinas
- 4.- Norma UNE-EN ISO 12100-1:2004
- 5.- Norma UNE-EN ISO 12100-2:2004
- 6.- Norma EN 614-1:1996
- 7.- Norma UNE-EN ISO 13850:2007
- 8.- Norma UNE-EN 60335-1

What type of gas do we use?

Our machines use liquid food grade Carbon dioxide gas. Carbon Dioxide, also called carbon oxide (IV), carbonic gas and carbon anhydride, CO₂, is insipid, colourless, odourless and not flammable.

Although the most common state of CO₂ is gaseous, under certain conditions it can also be found in liquid or solid state. These bottles are used for medical and food uses and they are different from the rest in that their interiors have a probe that extracts the cryogenic liquid which when freed reaches temperatures of -79.8 °C

LACOR Safety

- 1.- Operability based on liquid food grade carbon dioxide gas
- 2.- Control of gas pressure. Control of freezing temperature of the gas adjustable from -8 to -55 °C
- 3.- Manufactured from Stainless Steel for medical and food use. All the internal conducts are manufactured from AISI-316 guaranteeing optimal food and hygienic-health conditio
- 4.- Adaptable to any size of glass
- 5.- Exclusive patented safety system and control for pressures above 100 bar

Our articles fulfil the following standards:

- 1.- Directive 2006/95/CE for electrical safety
- 2.- Directive 2004/108/EC for electromagnetic compatibility
- 3.- Directive 2006/42/CE for machinery
- 4.- UNE-EN ISO 12100-1:2004 Standard
- 5.- UNE-EN ISO 12100-2:2004 Standard
- 6.- EN 614-1:1996 Standard
- 7.- UNE-EN ISO 13850:2007 Standard
- 8.- UNE-EN 60335-1 Standard



PROFESIONALES

Básculas

Professional use



- Batería interna recargable (autonomía de 15 días).
- Visor de nivel, planitud.
- Avisador acústico de sobrecarga.
- Teclado intuitivo y de fácil uso. Funciones de calculadora.
- Acumulación de importes.
- Unidades de medida (Kg · oz · Libras). Función de tara.
- Libro de instrucciones en 7 idiomas.

- Batterie interne rechargeable (autonomie 15 jours).
- Indicateur de niveau, de planéité.
- Avertisseur acoustique de surcharge.
- Clavier intuitif d'utilisation facile. Fonctions de calculatrice.
- Accumulation de sommes
- Unités de mesure: (Kg · Oz · Livres). Fonction de tare
- Mode d'emploi en 7 langues

- Rechargeable internal battery (last 15 days).
- Level and fatness indicator .
- Overload alarm.
- Intelligent and easy-to-use keyboard. Calculator funtions. Total counter.
- Measurement units: (Kg · Oz · pounds). Tare function
- Instructions book in 7 languages.

CERTIF.: 89/336/ECC, 91/263/EEC, 92/31/ECC, 93/68/EEC en 50 082 - 1:1992

Báscula industrial con base

Balance industrielle avec base · Industrieller Küchenwaage mit Sockel
 Industrial scale with base · Balança industrial com base

Ref	€	U.Venta
61700	1146,70	1

Ref	Tensión/Voltage	Tara/Tare	Dimensiones/Sizes	Peso/Weight
61700	220-240 V / 50-60 Hz	150 Kgr (20 g)	49x75x90 cm	45 Kg

Plataforma inoxidable 30x24 cm
Plataforma extraíble
Doble display (Delante / Detrás)
Teclado intuitivo y de fácil uso
Patas de apoyo regulables

St. Steel platform, 30x24 cm
 Removable platform
 Double display (Front / Back)
 Intelligent and easy-to-use keyboard
 Adjustable support feet



Báscula profesional electrónica

Balance électronique professionnelle · Elektronische Profi-Waagen
 Electronic professional scale · Balança eletrônica profissional

Ref	€	Tara
61716	472,20	15kg/5g
61730	508,10	30kg/10g

- Batería interna recargable (autonomía 15 días).
- Visor de nivel, planitud.
- Avisador acústico de sobrecarga.
- Funciones cambio.
- Seis memorias programables.
- Unidades de medida (Kgs., Oz., Libras). Función de tara.
- Libro de instrucciones en 7 idiomas.

- Batterie interne rechargeable (Autonomie 15 jours).
- Indicateur de niveau, de planéité.
- Avertisseur acoustique de surcharge.
- Fonctions changement.
- Six mémoire programmable.
- Unités de mesure: (Kgs., Oz., Livres). Fonction de tare.
- Mode d'emploi en 7 langues.

- Rechargeable internal battery (Last 15 days).
- Level and fatness indicator.
- Overload alarm.
- Change funtions.
- Six programmable memories.
- Measurement units: (Kgrs., Oz., pounds). Tare function.
- Instructions book in 7 languages.

CERTIF.: OIML R76 Clase III, 60/384/ECC

Ref	Tensión/Voltage	Potencia/Power	Tara/Tare	IP	Dimensiones/Sizes	Peso/Weight
61716	220-240 V / 50-60 Hz	0,2 W (max)	15 Kgr (5 g)	IPX 54	30x32x12 cm	4,60 Kg
61730	220-240 V / 50-60 Hz	0,2 W (max)	30 Kgr (10 g)	IPX 54	30x32x12 cm	4,60 Kg

No válidas para uso comercial · Utilisation interdite pour toutes transactions commerciales · Not for trade

LED Pizarra

Professional use



8 colores para usar con la pizarra eléctrica Led
No tóxicos, fácil de limpiar
8 colors to use with the Led electric board
Non toxic, easy to clean



Rotuladores fluorescentes 8 colores

Marqueurs fluorescents 8 couleurs · 8-Farben fluoreszierenden marker
Fluorescent markers 8 colors · Maracadores fluorescentes 8 cores

Ref	€	cm	U.Venta
39161	33,20	10	1

- Llamativo sistema de promoción. Gran impacto visual.
- Ideal para cualquier tipo de establecimiento: restaurantes, cafeterías, pubs, tiendas de alimentación, etc.
- Diseñadas para colocarlas tanto vertical como horizontalmente gracias a la cadena suministrada
- Uso similar de las pizarras normales, se escribe sobre la superficie (cristal templado) con rotuladores fluorescentes (Ref.:39161) y se borra con una simple bayeta de fibra.
- Realice el dibujo en la pizarra totalmente desenchufada.

- Système de promotion accrocheur. Grand impact visuel.
- Idéal pour tout type d'établissement : restaurants, cafés, pubs, magasins d'alimentation, etc.
- Conçu pour être placé aussi bien à la verticale qu'à l'horizontale, grâce à la chaîne fournie.
- Semblables à des tableaux normaux, ils permettent d'écrire sur la surface (verre trempé) avec des marqueurs fluorescents (Réf.:39161) et essuyés avec un simple chiffon en fibre.
- Dessinez sur le tableau complètement débranché.

- Eye-catching promotion system. Great visual impact.
- Ideal for any type of establishment: restaurants, cafés, pubs, food shops, etc.
- Designed to be placed both vertically and horizontally, thanks to the supplied chain
- Similar to normal blackboards, they are used for writing on the surface (tempered glass) with fluorescent markers (Ref.:39161) and wiped off with a simple fibre cloth.
- Draw on the blackboard completely unplugged.

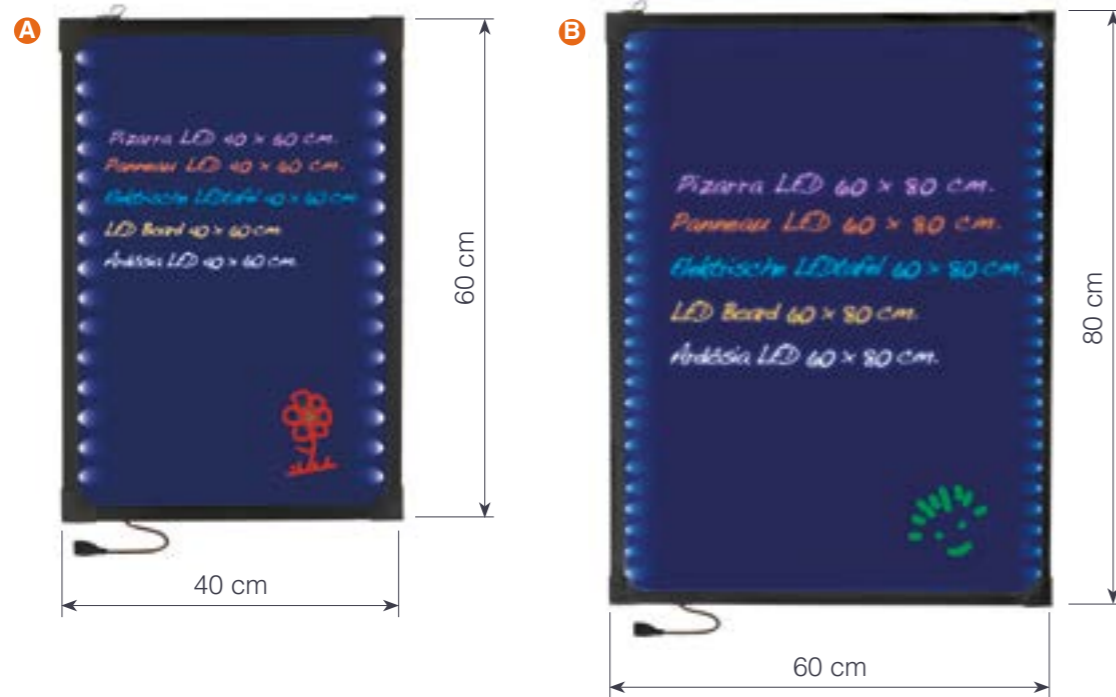

Pizarra LED

Tableau lumineux à LED · LED Tafel
Blackboard LED · Ardósia LED

Ref	€	W	U.Venta
A 39140	102,70	2	1
B 39160	141,00	2	1

Ref	Tensión/Voltage	Potencia/Power	Funcionado/Functions	Dimensiones/Sizes	Peso/Weight
39140	220-240 V; 50/60 Hz	2 W	38	40x60 cm	2,35 Kg
39160	220-240 V; 50/60 Hz	2 W	38	60x80 cm	4,50 Kg

NO incluidos
NOT included



ELÉCTRICOS Afiladores

Household use



Afilador de cuchillos eléctrico TitanPRO
Affûteuse de couteaux électrique · Elektrische Schärmaschine
Electric knife sharpener · Afiador de facas electrónico

Ref	€	U.Venta
69341	39,10	1



Ruedas de Alundum blanco
White alundum wheel



Afilador de cuchillos eléctrico ROND
Affûteuse de couteaux électrique · Elektrische Schärmaschine
Electric knife sharpener · Afiador de facas electrónico

Ref	€	U.Venta
69141	32,10	1



Afilador de cuchillos eléctrico PRO
Affûteuse de couteaux électrique · Elektrische Schärmaschine
Electric knife sharpener · Afiador de facas electrónico

Ref	€	U.Venta
69261	124,20	1



Afilador de cuchillos eléctrico MOUSE
Affûteuse de couteaux électrique · Elektrische Schärmaschine
Electric knife sharpener · Afiador de facas electrónico

Ref	€	U.Venta
60359	49,10	1

Ref: 69341

Características · Characteristics:

Tensión · Voltage: 220-240 V; 50-60 Hz

Potencia · Power: 60 W

Dimensiones · Sizes: 17x8x10 cm

Peso · Weight: 0,60 kg

- Permiten mantener los utensilios en perfecto estado.
- Diseño elegante, acabado metalizado.
- Dispone de diferentes ranuras para poder afilar distintos tipos de utensilios como cuchillos, tijeras o destornilladores de punta plana.
- El motor gira a la velocidad óptima para que el afilado de los utensilios sea preciso y duradero.
- 100% seguro: en su base se incluyen cuatro ventosas de fijación para evitar que el afilador se mueva durante su uso.

- Permet de maintenir les ustensiles en parfait état.
- Design élégant, finition métallisée.
- Dispose de différentes rainures pour pouvoir aiguiser différents types d'ustensiles tels que des couteaux, des ciseaux ou des tournevis.
- Le moteur tourne à une vitesse optimale pour que l'aiguisage des ustensiles soit précis et durable.
- 100% antidérapant : sa base possède quatre ventouses de fixation pour éviter que l'aiguiser bouge pendant son utilisation.

- Keeping kitchen utensils in perfect condition.
- Elegant design, metallic finish.
- It has different grooves for sharpening different utensils, like knives, scissors and flat-head screwdrivers.
- The motor spins at the optimal speed for precise and long lasting sharpening.
- 100% safe. There are four suction cups on the base to keep the sharpener from moving during use.

Ref: 69141

Características · Characteristics:

Tensión · Voltage: 220-240 V; 50 Hz

Potencia · Power: 60 W

Dimensiones · Sizes: 173,5x15x9 cm

Peso · Weight: 0,64 kg

Ref: 69261

Características · Characteristics:

Tensión · Voltage: 220-240 V; 50-60 Hz

Potencia · Power: 180 W

Dimensiones · Sizes: 32x11,5x210 cm

Peso · Weight: 2,20 kg

Fase 1 Fase 2 Fase 3



Fase 1: Alta abrasividad · high abrasiveness
Fase 2: Afilado fino · thin sharp
Fase 3: Microafilado · micro-sharp

Ref: 60359

Características · Characteristics:

Tensión · Voltage: 220-240 V; 50-60 Hz

Potencia · Power: 180 W

Dimensiones · Sizes: 16x11x7,5 cm

Peso · Weight: 20,56 kg



Cuchillos lisos · Smooth knives
Rejilla salida viruta · Chip outlet grid

CUCHILLOS

Estirizador



IP21



Esterilización mediante rayos ultravioletas germicidas que transforman el oxígeno en ozono, destruyendo bacterias, hongos y virus.

Sterilisation by ultraviolet germicidal rays that transform oxygen into ozone, destroying bacteria, fungi and viruses.

Armario esterilizador cuchillos ultravioleta

Armoire à stériliser · Sterilisierungsschank
Knife sterilization · Armário esterilizador facas

Ref	€	W	U.Venta	
A 39012	656,10	15	1	10 cuchillos · 10 Knives
B 39124	879,50	15	1	20 cuchillos · 20 Knives

Ref	Cuchillos/Knives	Tensión/Voltage	Potencia/Power	Reloj/Timer	Dimensiones/Sizes	Peso/Weight
39012	10	230 V; 50/60 Hz	15 W	120 min	36x13x57 cm	4,785 Kg
39124	20	230 V; 50/60 Hz	15 W	120 min	45x13x57 cm	5,630 Kg

MATAMOSQUITOS

Colección



ES

- Perfecto para el uso en lugares públicos como bares, restaurantes, hoteles, etc.
- Su elegante diseño es ideal para darle un toque moderno a cualquier espacio.
- Discreto, silencioso y seguro, sin descarga eléctrica.
- Es una alternativa perfecta a los insecticidas y matamosquitos tradicionales.
- No contamina (sin químicos ni venenos); evita la fragmentación del insecto y la dispersión de las bacterias.
- La luz ultravioleta atrae todo tipo de insectos voladores los cuales se eliminan mediante el papel adhesivo.
- El papel adhesivo se sustituye en segundos, ofreciendo una limpieza fácil y rápida.

FR

- Parfait pour une utilisation dans des lieux publics tels que des bars, restaurants, hôtels, etc.
- Son style est idéal pour apporter une touche moderne à tout type d'espace.
- Discret, silencieux et sûr, sans décharge électrique.
- Il s'agit d'une excellente alternative aux insecticides et tue-mouches traditionnels.
- Ne pollue (pas de produits chimiques ou de poisons), évite la fragmentation de l'insecte et la dispersion des bactéries.
- La lumière ultraviolette attire tout type d'insectes volants, qui sont éliminés à travers le papier adhésif.
- Le remplacement du papier adhésif s'effectue en quelques secondes, permettant ainsi un nettoyage facile et rapide.

EN

- Perfect for public places like bars, restaurants, hotels, etc.
- It's elegant design is perfect for giving a modern touch to any space.
- It's discrete, quiet and safe and doesn't produce electric shocks.
- It's a perfect alternative to insecticides and traditional.
- Doesn't pollute (no chemicals or poisons), it doesn't crush insects and spread bacteria.
- The UV light attracts all kinds of flying insects which get eliminated using adhesive paper.
- The adhesive paper can be changed in seconds for fast and easy cleaning.

Sin descargas eléctricas
Doesn't produce electric shocks



Matamosquitos DECOR

Anti-moustiques · Fliegenfänger
Moskito killer · Mata mosquitos

Ref	€	W	Área protección	U.Venta
39135	102,50	35	60 m ²	1

Ref	Tensión/Voltage	Potencia/Power	Área protec./Prot. area	Lámparas/Lamps	L. cable./Cord length	Dimensiones/Sizes	Peso/Weight
39135	220-240 V; 50/60 Hz	35 W	60 m ²	2 x 15W	115 cm	42x23,8x17,3 cm	1,36 Kg

* Se recomienda reemplazar el papel adhesivo cada 10 días pero si más de 2/3 del papel está cubierto de moscas, reemplaza el papel
It is recommended that you replace the sticky fly paper every 10 days but if more than 2/3 of the paper is covered in flies, replace the paper

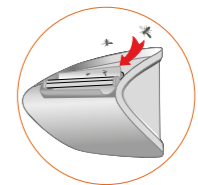

Set de 3 láminas adhesivas

Ensemble de 3 feuilles adhesives · Set von 3 Klebe Folie
Set of 3 adhesives sheet · Conjunto de 3 folhas adesivas

Ref	€	U.Venta
R39135C	13,30	1



Matamosquitos LUCE

Anti-moustiques · Fliegenfänger
Moskito killer · Mata mosquitos

Ref	€	W	Área protección	U.Venta
A 39126	90,30	11	150 m ²	1
B 39127	110,50	13	300 m ²	1

- Diseñado para lugares públicos como bares, restaurantes, hoteles, etc.
- Dispone de lámparas UV-A de alta calidad y con una longitud de onda óptima para atraer a todo tipo de insectos voladores.
- Una alternativa perfecta a los insecticidas, libre de contaminación e inocuo para los humanos.
- Dispone de rejilla metálica de alto voltaje en el interior donde los insectos son electrocutados con una tasa de eliminación instantánea y del 100%.
- Bandeja desmontable recoge insectos en la parte inferior, facilita la limpieza.
- Se instala fácilmente. Incluye dos cadenas para colgar.

- Conçu pour des lieux publics tels que les bars, les restaurants, les hôtels, etc.
- Dispose de lampes UV-A de grande qualité avec une longueur d'onde optimale pour attirer tout type d'insectes volants.
- Une alternative parfaite aux insecticides, sans contamination et inoffensif pour les humains.
- Dispose d'une grille métallique de haut voltage à l'intérieur où les insectes sont électrocutés avec un taux d'élimination instantanée de 100%.
- Plateau démontable ramasse-insectes dans la partie inférieure, qui facilite le nettoyage.
- Installation facile. Inclut deux chaînes pour l'accrocher.

- Designed for public spaces such as bars, restaurants, hotels, etc.
- Powerful high-quality UV-A lamps with an optimal wavelength to attract all types of flying insects.
- A perfect alternative to insecticides, free from contamination and harmless to humans.
- It has an internal high-voltage metal grill that instantaneously electrocutes insects with a 100% elimination rate.
- Removable tray that collects insects on the bottom, facilitating cleaning.
- Installs easily. Includes two chain for hanging.

Vida útil de trabajo
Functional lifespan
20.000 h

Vida útil de trabajo: 10.000 h
Useful working life: 10,000 h

Incluye cuerda para colgar
Includes a cord for hanging



PP
polypropylene

Matamosquitos WHITE

Anti-moustiques · Mückenfalle
Mosquito killer · Mata-mosquitos

Ref	€	W	Área protección	U.Venta
39129	64,90	3,5	50 m ²	1

- Uso interior: hogar, oficinas, hoteles, locales comerciales, restaurantes, etc.
- Dispone de 2 lámparas LED de alta calidad y con una longitud de onda óptima para atraer a todo tipo de insectos voladores.
- Una alternativa perfecta a los insecticidas, libre de contaminación e inocuo para los humanos.
- Rejilla metálica de 2500V en el interior donde los insectos son electrocutados.

- Utilisation en intérieur : logements, bureaux, hôtels, boutiques, restaurants, etc.
- Dispose de 2 ampoules LED de grande qualité et d'une longueur d'onde optimale pour attirer tout type d'insectes volants.
- Une alternative parfaite aux insecticides, sans contamination et inoffensive pour les humains.
- Dispose d'une grille métallique de 2500V à l'intérieur, où les insectes sont électrocutés.

- Designed for indoor use: Home, offices, hotels, businesses, restaurants, etc.
- It has 2 high quality LED lights with an optimal wavelength for attracting all kinds of flying insects.
- It's a perfect alternative to insecticide because it's pollution free and innocuous to humans.
- It has a 2500 V metal screen inside where insects are electrocuted.

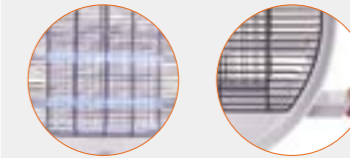

Ref	Tensión/Voltage	Potencia Power	Longitud onda Wavelength	Descarga eléct. Electric shock	Área protección Protection area	Vida útil Useful life	Cable Cord	Dimensiones Sizes	Peso Weight
39129	220-240 V; 50/60 Hz	3,5 W	398 m	2500 V	50 m ²	10.000 h	1,50 m	Ø36,6x8,3 cm	1,40 Kg

Soporte colgador
Luz ultravioleta
Bandeja recoge mosquitos
Hanger support
Ultraviolet light
Tray collection mosquitoes

Soporte colgador
Luz ultravioleta
Bandeja recoge mosquitos
Ventilador
Hanger support
Ultraviolet light
Tray collection mosquitoes
Ventilator



Matamosquitos NET

Appareil anti-moustiques noir · Fliegenfänger, schwarz
Moskito killer black · Mata mosquitos preto

Ref	€	W	Área protección	U.Venta
A 39138	20,90	4	40 m ²	1
B 39139	23,60	6	60 m ²	1

Ref	Tensión/Voltage	Potencia/Power	Area protec./Prot. area	Dimensiones/Sizes	Peso/Weight
39138	220-240 V; 50/60 Hz	4 W	40 m ²	Ø12x25 cm	350 g
39139	220-240 V; 50/60 Hz	6 W	60 m ²	Ø12x33 cm	875 g
39133	220-240 V; 50/60 Hz	13 W	50 m ²	Ø27x27 cm	950 g

Matamosquitos BLACK

Appareil anti-moustiques · Fliegenfänger
Moskito killer · Mata mosquitos

Ref	€	W	Área protección	U.Venta
39133	35,60	13	50 m ²	1



Protección
Protection
IPX0

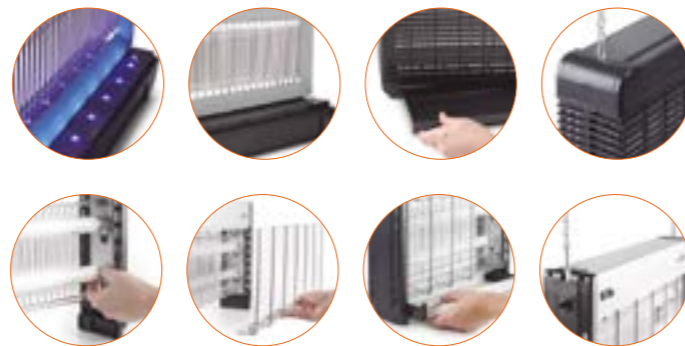

Matamosquitos CAPTER

Anti-moustiques · Fliegenfänger
Moskito killer · Mata mosquitos

Ref	€	W	Área protección	U.Venta
A 39134	75,00	26	80 m ²	1
B 39136	83,90	30	100 m ²	1

Ref	Tensión/Voltage	Potencia/Power	Bombillas/Bulbs	Area protec./Prot. area	Descarga/Shock	Dimensiones/Sizes	Peso/Weight
39126	220-240 V; 50/60 Hz	11 W	16 UV-A LED	150 m ²	4000 V	33x10x36,3 cm	1,50 Kg
39127	220-240 V; 50/60 Hz	13 W	20 UV-A LED	300 m ²	4000 V	47x10x36,3 cm	3,00 Kg
39134	220-240 V; 50/60 Hz	26 W	2x10W UV-A LED	80 m ²	2000 V	38,5x9x31 cm	2,75 Kg
39136	220-240 V; 50/60 Hz	30 W	2x15W UV-A LED	100 m ²	2000 V	49,5x9x31 cm	3,15 Kg

CALENTADORES

Colección

Professional use



ES

- Ideal para bares y restaurantes con mesas en el exterior.
- Funciona mediante lámparas de calentamiento halógeno infrarrojos.
- Malla protectora para evitar quemaduras.
- Resistente al polvo y agua (IP).

FR

- Idéal pour les bars et les restaurants ayant des tables à l'extérieur.
- Fonctionne à l'aide de lampes de réchauffement halogènes par infrarouges.
- Maillage de protection pour éviter les brûlures.
- Résistant à la poussière et à l'eau (IP).

EN

- Ideal for bars and restaurants with tables outside.
- Powered by infrared halogen heating lamps.
- Protective mesh to prevent burns.
- Dust and water resistant (IP).

¿Qué es la clasificación IP? · What is the IP classification?

IP 54

1º dígito; protección contra objetos y polvo 1st digit; protection against objects and dust	2º dígito; protección contra líquidos 1st digit; protection against liquids
IP0: Sin protección · Without protection	IPX0: Sin protección · Without protection
IP1: Protección contra objetos con un Ø mayor de 50 mm Protection against objects with Ø greater than 50 mm	IPX1: Protección contra gotas de agua Protection against water drops
IP2: Protección contra objetos con un Ø mayor a 12 mm Protection against objects with Ø greater than 12 mm	IPX2: Protección contra el goteo de agua con una inclinación de 15° · Protection against dripping water with an inclination of 15°
IP3: Protección contra objetos con un Ø mayor a 2,5 mm Protection against objects with Ø greater than 2,5 mm	IPX3: Protección contra pulverización Protection against spray
IP4: Protección contra objetos con un Ø mayor a 1 mm Protection against objects with Ø greater than 1 mm	IPX4: Protección contra salpicaduras · Splash protection
IP5: Protección contra polvo · Protection against dust	IPX5: Protección contra chorros de agua Protection against water jets
IP6: A prueba de polvo · Testing against dust	IPX6: Protección contra aguaceros Protection against downpours
	IPX7: Protección contra la inmersión durante un tiempo determinado · Protection against immersion for a certain time
	IPX8: Protección contra permanencia bajo agua Protection against permanence under water

Rejilla protectora
Protective grill



Selector nivel de calentamiento
Heating level selector



AL
Aluminium

Calentador eléctrico pie

Chauffage électrique sur pied · Standheizstrahler
Free standing electric heater · Aquecedor eléctrico de pé

Ref	€	W	U.Venta
69414	454,90	2100	1

Ref	Tensión/Voltage	Potencia/Power	Lámparas Lamps	N. calentamiento Heating levels	Ángulo de giro Angle of rotation	Nivel protección Protection level	Dimensiones Sizes	Peso/Weight
69414	220-240 V ; 50/60 Hz	2100 W	2	3 (900/1200/2100W)	40°	IP54	45x45x210 cm	17,0 Kg

- Desmontable en 3 partes, lo cual facilita el almacenaje de larga duración.
- El cabezal del calentador tiene un radio de giro de 40°.
- Base redonda y pesada para una mejor estabilidad y seguridad.
- Seguro y respetuoso con el medio ambiente, no produce ni ruidos ni olores.
- Incluye unos accesorios para el anclaje del calefactor.

- Démontable en 3 parties, ce qui facilite le rangement de longue durée.
- La tête du chauffage a un rayon de rotation de 40°.
- Base ronde et lourde pour une meilleure stabilité et sécurité.
- Sûr et respectueux de l'environnement, ne produit ni bruit ni odeurs.
- Inclut des accessoires pour l'ancrage du chauffage.

- Can be disassembled into 3 parts for easy long term storage.
- The head of the heater has a 40° rotation radius.
- Heavy round base for better stability and safety.
- Safe and environmentally friendly. Does not produce noise or odours.
- Includes accessories for anchoring the heater.

Área de calentamiento · Heating area

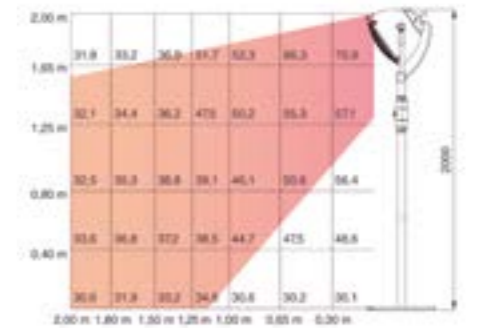

Área de calentamiento · Heating area



AL
Aluminium

Inox

Calentador pie

Rechauffeur pied · Heizung m/Ausziehbarer Fuß
Lamp · Aquecedor com pé

Ref	€	U.Venta
A 69410	343,90	1
B 69411	407,70	1

Ref	Tensión/Voltage	Potencia/Power	IP	Altura/Height	Cable/Cord	Calent./Heating	Dimensiones/Sizes	Peso/Weight
69410	220-240 V; 50/60 Hz	900/1200/2100 W	IP44	2,10 m	3,5 m	Lámpara calentamiento halógeno Halogen heating lamp	Ø58,5x1,6 - 2,10 m	13,35 Kg
69411	220-240 V; 50/60 Hz	1200/1800/3000 W	IP44	2,10 m	3,5 m		Ø76x2,10 m	14,40 Kg

Cadena de 1 m de longitud
1 m long chain



- Fácil de montar, incluye una cadena de 1 m de longitud para instalarla en el techo.
 - Cuenta con un control remoto para encender y apagar la lámpara calentadora.
 - Calor instantáneo, tiene 3 niveles de calentamiento (900 / 1200 / 2100 W).
 - Seguro y respetuoso con el medio ambiente, no produce ni ruidos ni olores.
- Facile à monter, il inclut une chaîne de 1 m de longueur pour l'installer au plafond.
 - Dispose d'une télécommande pour allumer et éteindre la chauffage.
 - Chaleur instantanée, dispose de 3 niveaux de chauffe (900 / 1200 / 2100 W).
 - Sûr et respectueux de l'environnement, ne produit ni bruit ni odeurs.
- Easy to assemble. Includes a 1m chain for ceiling installation.
 - The lamp heater has a remote control to turn it on and off.
 - Instant heat. It has 3 heating levels (900 / 1200 / 2100 W).
 - Safe and environmentally friendly. Does not produce noise or odours.

NOTA: Para instalar el calentador tenga en cuenta las distancias mínimas de seguridad que aparecen en la imagen
NOTE: Be aware of the minimum safety distances shown in the image when installing the heater

Área de calentamiento · Heating area

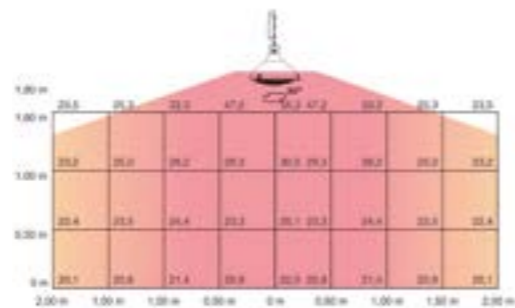

Rejilla protectora
Protective grill

Lámpara calentadora de techo

Parasol chauffant électrique suspendu · Elektrischer Deckenheizstrahler
Electric hanging lamp heater · Candeeiro aquecedor elétrico de teto

Ref	€	W	U.Venta
69422	209,80	2100	1

Ref	Tensión/Voltage	Potencia/Power	Lámparas Lamps	N. calentamiento Heating levels	Long. cadena Chain length	Nivel protección Protection level	Dimensiones Sizes	Peso/Weight
69422	220-240 V; 50/60 Hz	2100 W	2	3 (900/1200/2100W)	1,0 m	IP44	43x43x36 cm	3,15 Kg



Área de calentamiento · Heating area

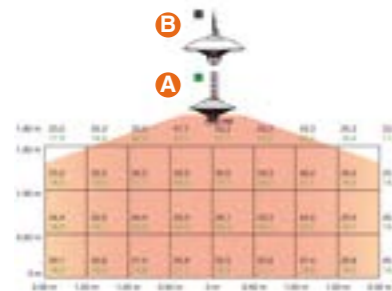

Lámpara calentador

Lampe chauffe · Heizelement, freihängend
Lamp 3 Lâmpada aquecedora

Ref	€	W	U.Venta
69420	175,90	1500	1
69421	236,90	900/1200/1500	1



Área de calentamiento · Heating area

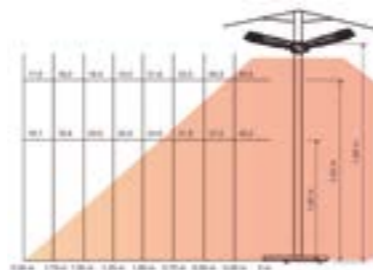

Calent. brazos abatibles

Lampe chauffe bras rebatibles · Heizgerät Arme ausklappbar
Heating lamp arms fold-away · Aquecedora braços rebatíveis

Ref	€	W	U.Venta
69423	234,00	2000	1

Ref	Tensión/Voltage	Potencia/Power	IP	Calent./Heating	Dimensiones/Sizes	Peso/Weight
69420	220-240 V; 50/60 Hz	1500 W	IP24	Lámp. calentamiento Halógeno infrarrojos	Ø42,5x25 cm	2,40 Kg
69421	220-240 V; 50/60 Hz	900/1200/2100 W	IP24	Halogen infrared heating lamp	Ø58,5x35 cm	2,75 Kg
69423	220-240 V; 50/60 Hz	2000 W	IP34	Halogen infrared heating lamp	Ø100x8,5 cm	3,60 Kg



Con control remoto
With remote control

Soporte extendido
Extended support



Área de calentamiento · Heating area

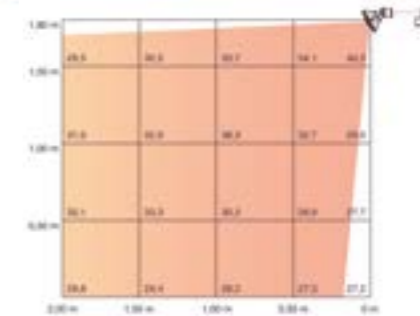

Calentador de pared

Chauffe de mur · Heizung, Hängeleiste
Wall lamp · Aquecedora de parede

Ref	€	W	U.Venta
69424	304,70	1500	1

Rejilla protectora
Incluye un soporte de pared con regulación angular
Cuerpo de aleación de aluminio anodizado
Calefactor de fibra de carbono de alta eficiencia
Protective grill
Includes a wall bracket with angular adjustment
Anodized aluminum alloy body.
High Efficiency Carbon Fibre Heating



Con control remoto
With remote control

AL
Aluminum

ABS
Plastic

Calentador de pared

Chauffe de mur · Heizung, Hängeleiste
Wall lamp · Aquecedora de parede

Ref	€	W	U.Venta
69425	201,30	1800	1
69426	236,30	2400	1

Ref	Tensión/Voltage	Potencia/Power	Lámparas Lamps	N. calentamiento Heating levels	Ángulo de giro Angle of rotation	Nivel protección Protection level	Dimensiones Sizes	Peso/Weight
69424	220-240 V; 50/60 Hz	1500 W	1	1	25° (eje vertical/vertical axis)	IP55	75x13x13cm	3,60 Kg
69425	220-240 V; 50/60 Hz	1800 W	1	1	25° (eje vertical/vertical axis)	IP65	65x21,5x24,5 cm	2,40 Kg
69426	220-240 V; 50/60 Hz	2400 W	1	1	25° (eje vertical/vertical axis)	IP65	85x22,5x26,5 cm	3,00 Kg

Accesorios · Accessoires · Accessories



Base con contrapeso
Counterbalanced base

Soporte para calentador

Support pour chauffe · Heizungshalterung
Support for lamp · Suporte para aquecedora

Ref	€	Ø (cm)	h (cm)	U.Venta
69427	73,10	40	190	1

Solo para uso en exteriores · Only for outdoor use

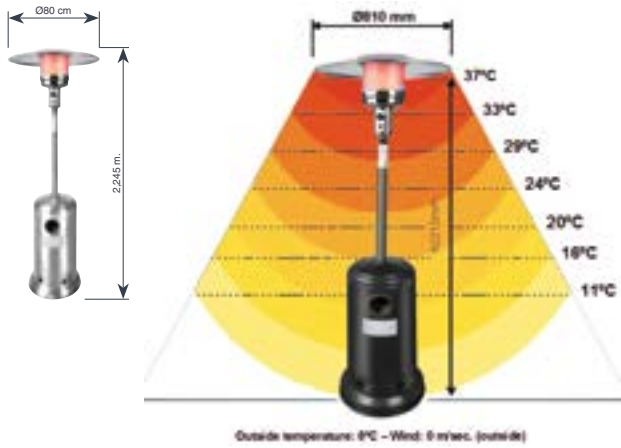

- Ideal para bares y restaurantes con mesas en el exterior.
- Indicado única y exclusivamente para exteriores.
- Disponible en dos acabados diferentes: acero inoxidable · negro.
- Malla protectora para evitar quemadura.

- Idéal pour les bars et les restaurants ayant des tables à l'extérieur.
- Destiné uniquement et exclusivement pour un usage en extérieur.
- Disponible en deux finitions différentes : acier inoxydable · noir.
- Maille de protection pour éviter les brûlures.

- Ideal for bars and restaurants with tables outside.
- Exclusively for outdoor use.
- Available in two different finishes: stainless steel · black.
- Protective mesh to prevent burns.

Accesorios · Accessoires · Accessories



Funda para calentador terraza a gas

Housse pour hauffage de terrasse à gaz · Abdeckung für Gas-Terrassenheizstrahler
Cover for outdoor gas heater · Capa protectora para aquecedor a gás para terraços

Ref	€	U.Venta
R69400N	17,30	1



Jgo. ruedas acero para calentador terraza

Ensemble de roves pour hauffage de terrasse à gaz · Rollen für Gas-Terrassenheizstrahler
Wheel set for outdoor gas heater · Jogo de rodas para aquecedor a gás para terraços

Ref	€	U.Venta
A R69400B	11,10	1
B R69400R	11,10	1

Calentador terraza a gas

Chauffage de terrasse à gaz 3 Gas-Terrassenheizstrahler
Outdoor gas heater · Aquecedor a gás para terraços

Ref	€	U.Venta
A 69400	393,10	1
B 69401	297,40	1

Ref	Potencia/Power	Posición piloto/Pilot posit.	Altura/Height	Peso/Weight
69400	14 KW (max)	870 g/h	2,245 m	20 Kg
69401	14 KW (max)	870 g/h	2,245 m	22 Kg

Funciona con gas propano o butano · Uses propane or butane gas only