

PROFESSIONAL EQUIPMENT

2024 catalogue



SUMMARY

INTRO 4

CHOCOLATE 19

Pralines	22
Bars	84
Snacks	100
Figures	112
Specials & napolitains	172
Half-spheres & decorations	186

SEMIFREDDO & BAKING 206

Silicone moulds	208
Semifreddo moulds	240
Baking equipment	252
Pastry ring	276

ICE-CREAM 294

Ice-cream moulds	296
Shop accessories	306

MACHINERY 324

Chocolate melters & fountains	326
Special machinery	336

EQUIPMENT 366

Pastry bags & piping tips	368
Pastry tools	388
Decorative tools	436
Transport & storage	448

BANQUETING 456

Cups	458
Mini plates	480
Monoportion plates	484
Zen trays & bowls	488
Banqueting displays	492
Cake stands	504
Macaron displays & showcases	520

FOOD COLOURS 530

WHO WE ARE OUR HISTORY

Martellato Srl was born in the '80s from an idea of its founder, but its roots date back several years earlier. Nereo Martellato, Alessandro's father, had a deep connection with the world of pastry and bakery. He appreciated the dedication and passion he felt when talking to artisans, and with the same dedication and passion, he sought solutions to their requests.

The products he created arose from a need noticed in a pastry shop, from a conversation with a baker, from a glance in a laboratory. In this way, Nereo realized that professionals needed a wider range of items and, above all, solutions that would improve their work..

Martellato Srl nasce negli anni '80 da un'idea del suo fondatore, ma le sue radici risalgono già ad alcuni anni prima. Nereo Martellato, il padre di Alessandro, era profondamente legato al mondo della pasticceria e della panificazione. Apprezzava l'impegno e la passione che sentiva quando parlava con un artigiano, e con lo stesso impegno e passione cercava le soluzioni alle loro richieste.

I prodotti che lui creava nascevano da un'esigenza notata in una pasticceria, da una chiacchierata con un panettiere, da uno sguardo in un laboratorio. In questo modo Nereo si è accorto che i professionisti necessitavano di una gamma più ampia di articoli e soprattutto di soluzioni che migliorassero il loro lavoro.

TODAY, MARTELLATO RELIES ON THE THIRD GENERATION, ENSURING THE CONTINUITY OF SERVICES OFFERED WITH PASSION TO PROFESSIONALS AROUND THE WORLD.

OGGI L'AZIENDA MARTELLATO SI AFFIDA ALLA TERZA GENERAZIONE, ASSICURANDO LA CONTINUITÀ DEI SERVIZI CHE CON PASSIONE OFFRE A TUTTI I PROFESSIONISTI NEL MONDO.



35 YEARS OF PASSION AND HARD WORK

PRODUCTS

Through its products, the company positions itself as a partner to professionals worldwide, offering its expertise and capabilities in creating items that significantly enhance the activities of those who, with dedication, work in their own laboratories every day.

Thousands of items are conceived, designed, made, and distributed by Martellato with the precise intention of being the reference point for various sectors of the food industry.

Attraverso i suoi prodotti l'azienda si propone come partner dei professionisti di tutto il mondo, offrendo le proprie competenze e capacità nel realizzare articoli in grado di migliorare notevolmente il lavoro di chi ogni giorno, con dedizione, svolge l'attività all'interno del proprio laboratorio.

Migliaia di articoli sono pensati, progettati, realizzati e distribuiti con il preciso intento, da parte di Martellato, di essere il punto di riferimento per i diversi settori del comparto food.

OUR VALUES

In the future that Martellato envisions, there are many important goals to achieve. Always attentive to what the market demands, the company aims to be a point of reference globally, acting as an ambassador for Made in Italy, synonymous with quality and design, and offering products that allow pastry chefs to express their talent to the fullest.

Nel futuro che Martellato si aspetta ci sono tanti importanti traguardi da raggiungere. Sempre attenta a ciò che il mercato chiede, l'azienda vuole essere un punto di riferimento nel mondo facendosi ambasciatrice del Made in Italy, sinonimo di qualità e design, e offrendo prodotti che permettano ai pasticceri di esprimere al meglio il loro talento.

MADE IN ITALY

SUSTAINABILITY

AND RESPONSIBLE PRODUCTION

Commitment to the planet is part of our philosophy. Applying more efficient production processes can significantly reduce pollution, waste, and consumption. For this reason, our processes are geared towards zero waste production and reduced consumption.

We also commit to using eco-friendly and recyclable materials to reduce environmental impact. Recyclable materials thus become a resource for new productions.

L'impegno verso il pianeta è parte della nostra filosofia. Applicare processi di produzione più efficienti può ridurre in maniera significativa l'inquinamento, i rifiuti e i consumi. Per questo motivo le nostre lavorazioni sono orientate all'azzeramento degli scarti produttivi e alla riduzione dei consumi.

Ci impegniamo inoltre ad utilizzare materiali ecologici e riciclabili per ridurre l'impatto ambientale. Il materiale riciclabile diventa così una risorsa per nuove produzioni.

REDUCE, REUSE, RECYCLE
RIDUCI, RIUSA, RICICLA



CERTIFIED QUALITY

The quality and safety of all our products, as well as our services, specialization, research, and training, are constantly monitored to ensure high standards in compliance with European regulations on food safety, environmental, and business management.

La qualità e la sicurezza di tutti i nostri prodotti nonché dei nostri servizi, così come specializzazione, ricerca e formazione, sono costantemente controllate per garantire standard elevati nel rispetto delle Normative Europee sulla sicurezza alimentare, ambientale e gestione aziendale.



Martellato
is ISO
9001: 2015
certified.

BUY MORE & ASK FOR HIGH QUALITY



SOCIOECONOMIC CONTRIBUTION

Martellato together with Remix to generate social value. A socially responsible company reconciles its business with respect and appreciation for people.

In the context of projects for support and work integration, Remix has developed highly specific skills, demonstrating how even people in vulnerable situations can contribute positively to the local economy, producing quality products and services. Martellato has chosen to entrust part of the assembly of its products to Remix. By purchasing them, you will directly support this initiative and our commitment to a more inclusive society.

Martellato a fianco di Remix per generare valore sociale. Un'azienda socialmente responsabile concilia il proprio business con il rispetto e la valorizzazione delle persone.

Nell'ambito dei progetti per l'accompagnamento e l'inserimento lavorativo, Remix ha sviluppato delle competenze altamente specifiche che dimostrano come anche le persone in situazione di fragilità possano contribuire positivamente all'economia del territorio, realizzando prodotti e servizi di qualità.

Martellato ha scelto di affidare a Remix parte dell'assemblaggio dei propri prodotti. Acquistandoli supporterete direttamente questa realtà e il nostro impegno verso una società più inclusiva.

+ 120 COCOA TREES

The planet is a place that needs safeguarding. For this reason, we wanted to contribute by sharing an important reforestation project with our partners. Supported by the Treadom company, we have purchased 120 Cacao trees that have been planted by Cameroonian farmers in one of the agroforestry projects supported by the company.

Il pianeta è un luogo che va salvaguardato. Per questo abbiamo voluto dare un contributo condividendo con i nostri partner un importante progetto di riforestazione. Supportati dall'azienda Treadom, abbiamo acquistato 120 alberi di Cacao che sono stati piantati da contadini camerunensi in uno dei progetti agroforestali che l'azienda sostiene.



A GIFT FOR THE PLANET

Thanks to this initiative, Martellato also contributes to the financing of Cameroonian farmers, supporting their work and livelihood.

Grazie a questa iniziativa, inoltre, Martellato contribuisce al finanziamento di contadini Camerunensi, sostenendo il loro lavoro e quindi il loro sostentamento.

WE COULD OFFSET UP TO 7 TONS OF CO₂, EQUIVALENT TO THAT PRODUCED BY A TRAIN TRAVELING 440,040 KM.

STIAMO COMPENSANDO FINO A 7 TONNELLATE DI CO₂ PARI A QUELLA PRODOTTA DA UN TRENO CHE PERCORRE 440.040 KM.



AMBASSADORS

EXCELLENCE FROM ALL OVER THE WORLD



Frank Haasnoot

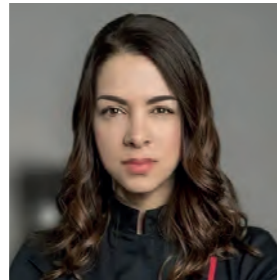

Melissa Coppel



Philip Khoury



Julien Alvarez



Camila García Elizalde



Nicolas Nikolakopoulos



Javier Guillén



Alexandre Bourdeaux



Karim Bourgi



David Pallas



Wei Loon Tan



Vinesh Johny



Luigi Biassetto



Massimo Carnio



Giuseppe Gagliardi

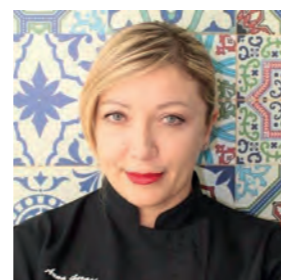

Anna Gerasi

HERE ARE THE MOST NOTABLE AND TALENTED INDIVIDUALS WE COLLABORATE WITH THE AIM TO OFFER THE BEST QUALITY PRODUCTS TO PROFESSIONALS IN THE INDUSTRY.

ECCO I PERSONAGGI PIÙ NOTI E TALENTUOSI CON CUI COLLABORIAMO, AL FINE DI OFFRIRE A TUTTI I PROFESSIONISTI DEL SETTORE LA MIGLIORE QUALITÀ DEI NOSTRI PRODOTTI.

**MARTELLATO UNDERSTANDS THE VALUE
OF TRAINING AND IS COMMITTED TO NETWORKING
WITH ACADEMIES AROUND THE WORLD TO NURTURE
THE TALENT OF ALL PROFESSIONALS.**

***MARTELLATO CONOSCE IL VALORE DELLA
FORMAZIONE E SI IMPEGNA A FARE RETE CON
LE ACCADEMIE DI TUTTO IL MONDO PER FORMARE
IL TALENTO DI TUTTI I PROFESSIONISTI.***

ACADEMIES

INSPIRATION COMES WITH TRAINING

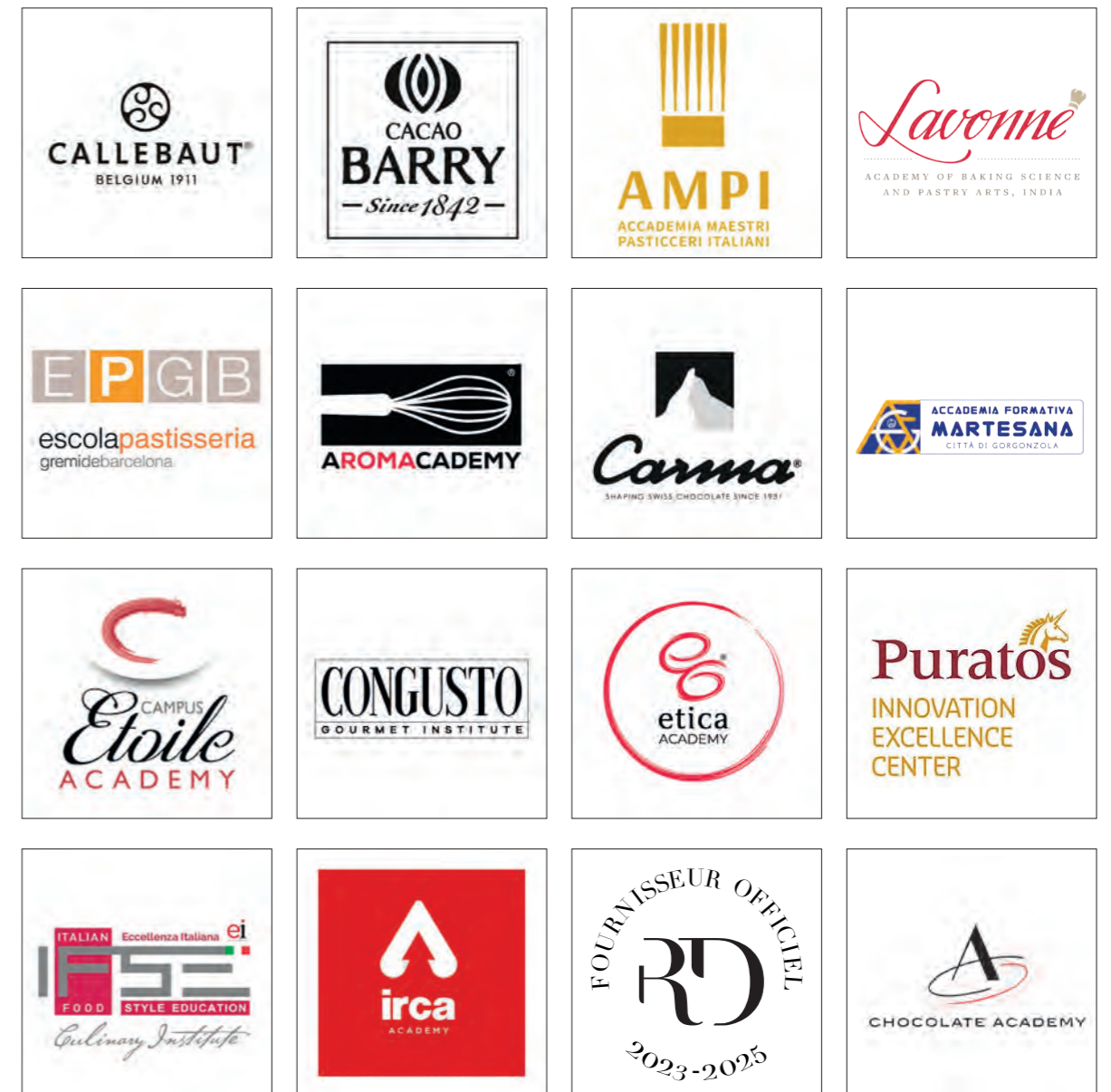

CHOCOLATE

PASSION FOR CHOCOLATE DESIGN

This section gathers a wide range of products for chocolate production: Supreme, a line of professional moulds for pralines, snacks, bars and subjects - Performance, a collection of One-Shot and rotating machines moulds - Thermoformed moulds, for producing both single subjects and 3D figures such as Easter eggs, spheres and Christmas trees - Stamps, combs and silicone mats to creating beautiful decorations - and much more to be discovered. With this range, Martellato offers to pastry chefs and chocolatiers a complete selection of products with which realize great aesthetic impact showcases, without missing quality and made-in-Italy design.

In questa sezione è raccolta un'ampia gamma di prodotti per il cioccolato: Supreme, linea di stampi professionali per praline, snack, tavolette e soggetti - Performance, la collezione di stampi dedicata alle macchine one shot e rotative - Termoformati, stampi per singoli soggetti o per la produzione di figure 3D come uova di Pasqua, sfere e alberi di Natale - Timbri, pettini e tappeti in silicone per realizzare bellissime decorazioni - e molto altro tutto da scoprire. Con questa gamma, Martellato offre ai pasticceri e ai cioccolatieri un assortimento completo di prodotti ideali per creare vetrine di grande impatto estetico, senza rinunciare alla qualità e al design made in Italy.



PRALINES

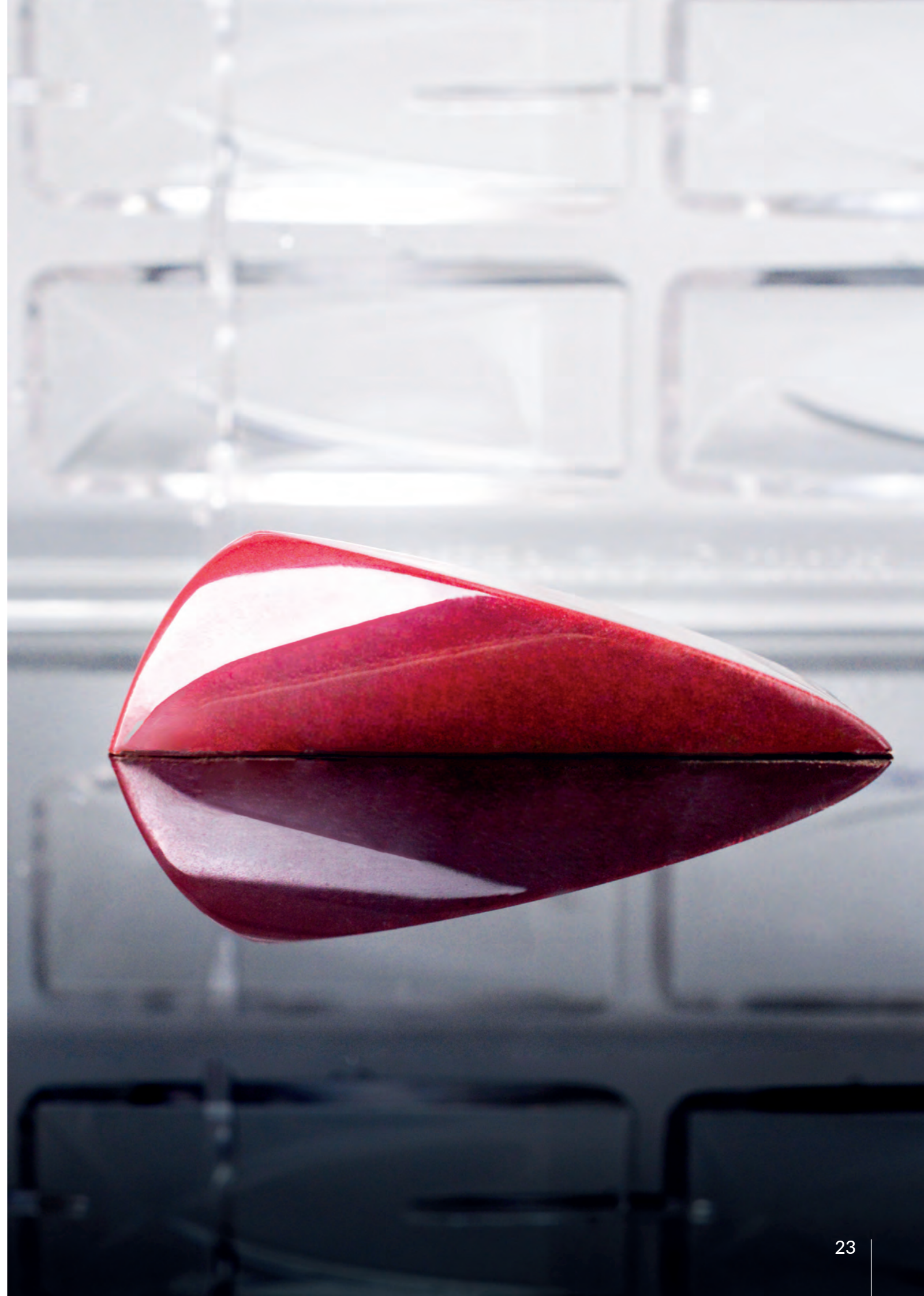

SPECIALS/SPECIALI

Vip | VERY IMPORTANT PRALINE

NEW COLLABORATIONS FOR UNIQUE PRALINES

A successful product is born when Craftsmanship meets Quality, which is why the VIP, Very Important Praline collection continues to be so successful.

Nine internationally renowned Pastry Chefs have chosen Martellato to create an exclusive line of chocolate moulds with attention to the smallest details, offering a unique design and a high level product. Each mould hides a true story inspired by the country, culture and personality of the Pastry Chef: discover the new Slope, Aotrom, Origami, Crystal, Hope and Beat!

Un prodotto di successo nasce quando la Maestria incontra la Qualità, ecco perché la collezione VIP, Very Important Praline, continua a riscuotere tanto successo.

Nove Pastry Chef di fama internazionale hanno scelto Martellato per creare una linea esclusiva di stampi per cioccolato curati nei minimi dettagli, offrendo un design unico e un prodotto di alto livello. Ogni stampo nasconde una vera e propria storia ispirata al paese, alla cultura e alla personalità del Pastry Chef: scoprite i nuovi Slope, Aotrom, Origami, Crystal, Hope e Beat!

Professional chocolate moulds 275 x 175 mm





PHILIP KHOURY

Award-winning pastry chef Philip Khoury is Head Pastry Chef at the prominent Harrods in London. Classically trained, he works to innovate through reformulation and reinvention. His philosophy aims to marry flavour, texture and beautiful presentation in what he calls the holy trinity of dessert enjoyment.

Il pluripremiato chef pasticcere Philip Khoury è capo pasticcere presso l'importante Harrods di Londra. Di formazione classica, lavora per innovare attraverso la riformulazione e la reinvenzione. La sua filosofia mira a coniugare sapore, consistenza ed estetica in quella che lui chiama la santa trinità del piacere del dessert.





New

Slope

60 x 20 h 17 mm
 Weight ~ 11 gr - Prod. 20 pcs
 Layout 4 x 5 - BPA Free
 Professional mould 275 x 175 mm

21MA1065

CREATED WITH
Philp Khoury



CAMILA GARCÍA ELIZALDE

Camila G. Elizalde is a Chilean pastry chef with many years of experience, and the owner and founder of StudioPas Academy, a specialized high-level pastry school with over 27,000 students. She has a community of over 190K followers, and in 2022, as the director of the Chilean national pastry selection, she became the American Pastry Champion, taking the first place in the Coupe du Monde Pâtisserie America 2022.

Camila G. Elizalde è una pastry chef cilena con molti anni di esperienza, fondatrice di StudioPas Academy, scuola di specializzazione in pasticceria di alto livello con più di 27.000 studenti. Ha una community di oltre 190K followers, e nel 2022 diventa American Pastry Champion come direttrice del national pastry team cileno, conquistando il primo posto alla Coupe du Monde Pâtisserie America 2022.





aotrom



New

Aotrom

29 x 29 h 19 mm
 Weight ~ 9,5 gr - Prod. 28 pcs
 Layout 7 x 4 - BPA Free
 Professional mould 275 x 175 mm

21MA1063

CREATED WITH
*Camila Garcia
 Elizalde*



MELISSA COPPEL

World-renowned Chocolatier and one of the few women at the top of her field, Melissa Coppel had many high-level experiences: she worked in Las Vegas at Joel Robuchon at the Mansion (3* Michelin), Caesars Palace and the Bellagio, before starting her own school in 2016.

Her creations earned her several accolades and she was also named one of the Top 10 Chocolatiers in North America by Dessert Professional.

Cioccolatiere di fama mondiale e una delle poche donne ai vertici del settore, Melissa Coppel ha avuto molte esperienze di alto livello: con Joel Robuchon at The Mansion (3 Michelin), Caesars Palace e Bellagio a Las Vegas, prima di avviare la sua scuola nel 2016.*

Le sue creazioni le sono valse vari riconoscimenti ed è stata nominata tra i 10 Migliori Cioccolatieri del Nord America da Dessert Professional Magazine.



New

Origami

45,5 x 46 h 16 mm

Weight ~ 10 gr - Prod. 15 pcs

Layout 5 x 3

Professional mould 275 x 175 mm

MA1058

CREATED WITH

Melissa Coppel



NICOLAS NIKOLAKOPOULOS

Nicolas is Greek Chocolate Master 2022 and ranked 3rd place at World Chocolate Masters. Throughout his career, he had gained invaluable experience in various hospitality establishments.

He is professor at Le Monde Institute of Tourism Studies in Athens, where his journey began, and he also provides master classes and consulting around the world. He also works as Pastry Chef at the NZ Dessert Designers.

Nicolas è Greek Chocolate Master 2022 e si è classificato al 3° posto al World Chocolate Masters. Nel corso della sua carriera, ha acquisito una preziosa esperienza in diverse strutture ricettive.

È professore al Le Monde Institute of Tourism Studies di Atene, dove è iniziato il suo percorso, e tiene consulenze e corsi di perfezionamento in tutto il mondo. È anche Pastry Chef di NZ Dessert Designers.



New

Crystal

55 x 25 h 14 mm
 Weight ~ 7,6 gr - Prod. 16 pcs
 Layout 4 x 4
 Professional mould 275 x 175 mm

MA1060

CREATED WITH

*Nicolas
 Nikolakopoulos*



ANNA GERASI

Anna Gerasi is Italian Chocolate Master 2022 and ranked 4th in the World Chocolate Master, the only woman to reach the final. "Chocolate is my favourite material: through it I create and communicate my art." An entrepreneur born in 1976, she runs the historic Piccinelli pastry shop in Brescia with her brother.

Anna Gerasi è Italian Chocolate Master 2022 e si classifica al 4° posto al World Chocolate Master, unica donna ad accedere alla finale. "Il cioccolato è la mia materia preferita: attraverso di lui creo e comunico la mia arte." Imprenditrice classe 1976, guida la storica pasticceria Piccinelli di Brescia il fratello.



New

Hope

32 x 32 h 18 mm
 Weight ~ 10 gr - Prod. 24 pcs
 Layout 6 x 4
 Professional mould 275 x 175 mm

MA1057

CREATED WITH
Anna Gerasi



MASSIMO CARNIO

World Champion, Italian Chocolate Champion and finalist at the World Chocolate Master, Massimo Carnio is a chocolatier and pastry chef by passion.

A Cacao Barry ambassador, he collaborates as a consultant with many companies in the pastry sector, as well as running with his wife the Villa dei Cedri pastry shop in Valdobbiadene (Treviso - Italy).

Campione del mondo e Campione Italiano di Cioccolateria, finalista al World Chocolate Master, Massimo Carnio è cioccolatiere e pasticcere per passione. Ambasciatore Cacao Barry, collabora come consulente con varie aziende del settore pasticceria, oltre a gestire con la moglie la pasticceria Villa dei Cedri a Valdobbiadene (Treviso).



New

Beat

30 x 30 h 17,5 mm
Weight ~ 11 gr - Prod. 24 pcs
Layout 6 x 4
Professional mould 275 x 175 mm

MA1062

CREATED WITH

Massimo Carnio



Flora

30 x 31 h 18 mm
 Weight ~ 11 gr - Prod. 24 pcs
 Layout 6 x 4
 Professional mould
 275 x 175 mm

MA1050



CREATED WITH

Javier Guillén



Dune

ø 31 h 21 mm
 Weight ~ 10 gr - Prod. 24 pcs
 Layout 6 x 4
 Professional mould
 275 x 175 mm

MA1052



CREATED WITH

Karim Bourgi



flow



mount



Flow

29 x 29 h 18 mm
 Weight ~ 11 gr - Prod. 24 pcs
 Layout 6 x 4
 Professional mould
 275 x 175 mm

MA1051



CREATED WITH

Wei Loon Tan



Mount

32 x 32 h 23 mm
 Weight ~ 9 gr - Prod. 24 pcs
 Layout 6 x 4
 Professional mould
 275 x 175 mm

MA1047



CREATED WITH

Philip Khoury



New

Venere

ø 31 h 22 mm
 Weight ~ 11 gr - Prod. 24 pcs
 Layout 6 x 4 - BPA Free
 Professional mould 275 x 175 mm

21MA1059



Jems Diamond

6 square - 30 x 30 h 15 mm - Weight ~ 11 gr
 6 oval - 42 x 24 h 15 mm - Weight ~ 10 gr
 6 round - ø 32 h 15 mm - Weight ~ 10 gr
 Layout 6 x 3
 Professional mould 275 x 175 mm

MA1994



Theobroma

52 x 26 h 14 mm
 ~ 9 gr - 21 pcs
 Layout 7 x 3
 Professional mould
 275 x 175 mm

MA1018





Pavillon

27 x 27 h 20 mm
 Weight ~ 10 gr - Prod. 28 pcs
 Layout 7 x 4
 Professional mould 275 x 175 mm

MA1041



Vault

26,5 x 26,5 h 20 mm
 Weight ~ 9 gr - Prod. 28 pcs
 Layout 7 x 4
 Professional mould 275 x 175 mm

MA1042

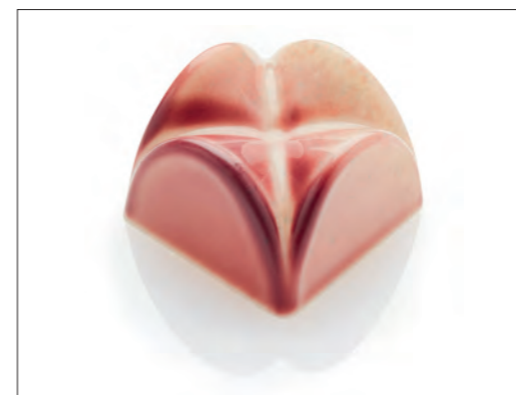

Cross

26,5 x 26,5 h 18 mm
 Weight ~ 11 gr - Prod. 28 pcs
 Layout 7 x 4
 Professional mould 275 x 175 mm

MA1043

Sweet 1



ø 32 h 23 mm
 Weight ~ 10 gr - Prod. 24 pcs
 Layout 6 x 4
 Professional mould 275 x 175 mm

MA1021

Sweet 2



ø 32 h 21 mm
 Weight ~ 11 gr - Prod. 24 pcs
 Layout 6 x 4
 Professional mould 275 x 175 mm

MA1022

Sweet 3



ø 32 h 19,5 mm
 Weight ~ 11 gr - Prod. 24 pcs
 Layout 6 x 4
 Professional mould 275 x 175 mm

MA1023

Sweet 4



ø 33 h 22 mm
 Weight ~ 10 gr - Prod. 24 pcs
 Layout 6 x 4
 Professional mould 275 x 175 mm

MA1024





Quadrato

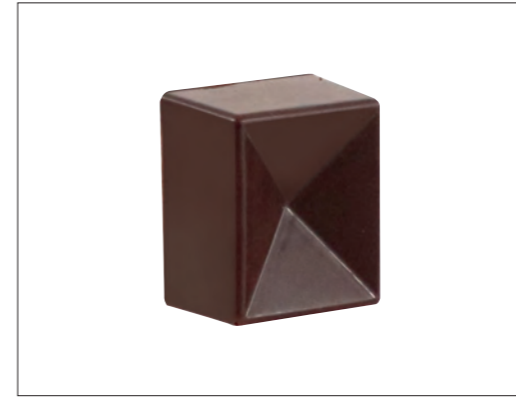

25 x 25 h 15,5 mm
 Weight ~ 11 gr - Prod. 28 pcs
 Layout 7 x 4
 Professional mould 275 x 175 mm

MA1008

Cerchio



ø 30 h 15,5 mm
 Weight ~ 11 gr - Prod. 28 pcs
 Layout 7 x 4
 Professional mould 275 x 175 mm

MA1007

Ottagono



ø 30 h 15,5 mm
 Weight ~ 11 gr - Prod. 28 pcs
 Layout 7 x 4
 Professional mould 275 x 175 mm

MA1010

Triangolo



33 x 29 h 15,5 mm
 Weight ~ 8 gr - Prod. 24 pcs
 Layout 6 x 4
 Professional mould 275 x 175 mm

MA1009



Wave 1

26,9 x 59 h 16 mm
 Weight ~ 10,4 gr - 14 pcs
 Layout 7 x 2
 Professional mould 275 x 175 mm

MA1003



Wave 2

27 x 59 h 17 mm
 Weight ~ 7,9 gr - 16 pcs
 Layout 8 x 2
 Professional mould 275 x 175 mm

MA1004

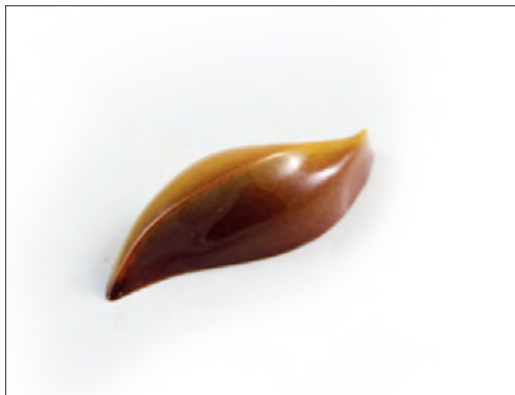

Wave 3

24,3 x 61,5 h 15,4 mm
 Weight ~ 9,8 gr - 16 pcs
 Layout 8 x 2
 Professional mould 275 x 175 mm

MA1005

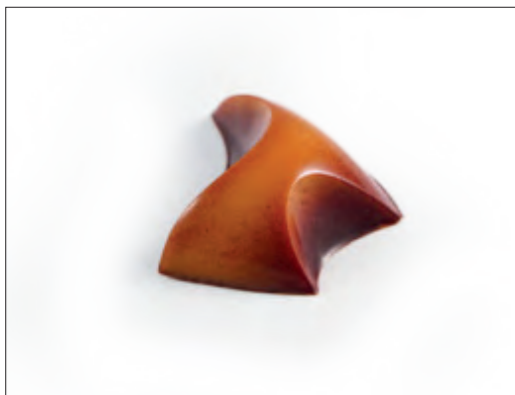

Wave 4

43,8 x 38,1 h 14,1 mm
 Weight ~ 9,4 gr - 15 pcs
 Layout 5 x 3
 Professional mould 275 x 175 mm

MA1006



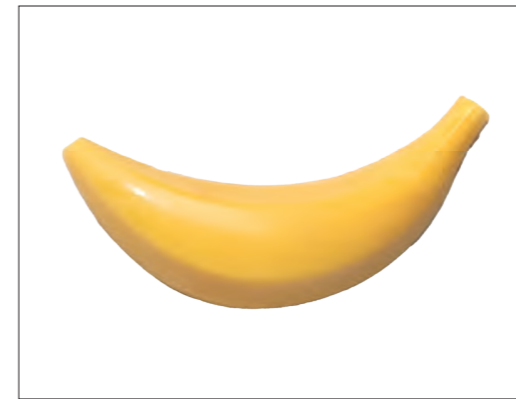

Banana

64 x 19 h 15 mm
 Weight ~ 10 gr - 16 pcs
 Layout 8 x 2
 Professional mould 275 x 175 mm

MA1033



Pera

44 x 32 h 17 mm
 Weight ~ 11 gr - 18 pcs
 Layout 6 x 3
 Professional mould 275 x 175 mm

MA1034



Noce

37 x 29 h 17,5 mm
 Weight ~ 11 gr - 18 pcs
 Layout 6 x 3
 Professional mould 275 x 175 mm

MA1035



Arachide

50 x 23 h 15,5 mm
 Weight ~ 11 gr - 20 pcs
 Layout 4 x 5
 Professional mould 275 x 175 mm

MA1036



Professional chocolate mould
 Stampi professionali per cioccolato
 275 x 175 mm

Domes



38 x 26 h 19 mm
 Weight ~ 11 gr - 24 pcs
 Layout 6 x 4

MA4010

Cubes



36 x 25 h 16 mm
 Weight ~ 10 gr - 24 pcs
 Layout 6 x 4

MA4011

Hearts



43 x 26 x h 16 mm
 Weight ~ 11 gr - 20 pcs
 Layout 5 x 4

MA4012

Dome XL

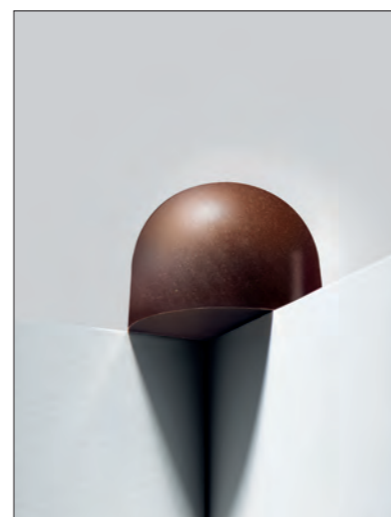

ø 43 h 33 mm
 Weight ~ 40 gr - Prod. 12 pcs
 Layout 4 x 3

MA1038

Stud XL

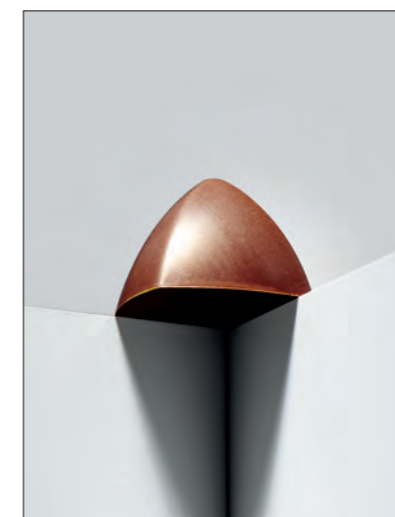

45 x 45 h 33 mm
 Weight ~ 34 gr - Prod. 12 pcs
 Layout 4 x 3

MA1039

Pastry XL



ø 45 h 33 mm
 Weight ~ 38 gr - Prod. 12 pcs
 Layout 4 x 3

MA1040

Professional chocolate mould
 Stampi professionali per cioccolato
 275 x 175 mm



Triangular

25 x 26 h 55 mm
 Weight ~ 11 gr - Prod. 28 pcs
 Layout 7 x 4

MA4005



Octagonal

25 x 25 h 55 mm
 Weight ~ 11 gr - Prod. 28 pcs
 Layout 7 x 4

MA4006



Cone

25 x 25 h 55 mm
 Weight ~ 11 gr - Prod. 28 pcs
 Layout 7 x 4

MA4007



MODERN/MODERNE



Rocket

ø 23 h 29 mm
 Weight ~ 9 gr - Prod. 28 pcs
 Layout 7 x 4
 Professional mould 275 x 175 mm

MA1044

Professional chocolate mould
Stampi professionali per cioccolato
 275 x 175 mm

Turn



40 x 19 h 16 mm
 ~ 10 gr - Prod. 25 pcs
 Layout 5 x 5

MA1013

Twist



39,5 x 19 h 16 mm
 ~ 11 gr - Prod. 25 pcs
 Layout 5 x 5

MA1014

Flat



40 x 18 h 16 mm
 ~ 11 gr - Prod. 25 pcs
 Layout 5 x 5

MA1015

Pill



40,5 x 18 h 16 mm
 ~ 10 gr - Prod. 25 pcs
 Layout 5 x 5

MA1016

Thimble



ø 23 h 28,5 mm
 ~ 11,5 gr - Prod. 28 pcs - Layout 7 x 4

MA1045

Oblio



ø 32 h 23 mm
 ~ 8 gr - Prod. 24 pcs
 Layout 6 x 4

MA1049

Side

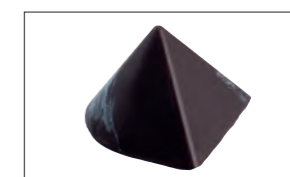

32 x 32 h 23 mm
 ~ 9 gr - Prod. 24 pcs
 Layout 6 x 4

MA1048

Triangle



39 x 20 h 16 mm
 ~ 7 gr - Prod. 27 pcs
 Layout 9 x 3

MA1999

Plain



39 x 18 h 15,5 mm
 ~ 10 gr - Prod. 30 pcs
 Layout 10 x 3

MA1998

Curvy



39 x 18 h 15,5 mm
 ~ 10 gr - Prod. 30 pcs
 Layout 10 x 3

MA1997



CLASSIC/CLASSICHE

Professional chocolate mould
Stampi professionali per cioccolato
275 x 175 mm



∅ 30 h 19 mm
~ 12 gr - 28 pcs
Layout 7 x 4
MA1002



50 x 25 h 15 mm
~ 9 gr - 21 pcs
Layout 7 x 3
MA1011



54 x 24 h 16 mm
~ 9 gr - 21 pcs
Layout 7 x 3
MA1012



25 x 25 h 23 mm
~ 13 gr - 40 pcs
Layout 8 x 5
MA1019



25 x 25 h 18 mm
~ 10 gr - 28 pcs
Layout 7 x 4
MA1020



33 x 22 h 20 mm
~ 15 gr - 30 pcs
Layout 6 x 5
MA1025



∅ 29 h 21 mm
~ 8 gr - 40 pcs
Layout 8 x 5
MA1037



37 x 31 h 16 mm
~ 14 gr - 28 pcs
Layout 7 x 4
MA1046



32 x 23 h 16 mm
~ 9 gr - 36 pcs
Layout 6 x 6
MA1064



38 x 28 h 18 mm
~ 15 gr - 30 pcs
Layout 6 x 5
MA1074



35 x 20 h 17 mm
~ 12 gr - 30 pcs
Layout 6 x 5
MA1082



∅ 28 h 23 mm
~ 10 gr - 40 pcs
Layout 8 x 5
MA1091



∅ 30 h 22 mm
~ 14 gr - 28 pcs
Layout 7 x 4
MA1094



17 x 12 h 5 mm
~ 1 gr - 130 pcs
Layout 13 x 10
MA1281



27 x 27 h 18 mm
~ 11 gr - 28 pcs
Layout 7 x 4
MA1303



∅ 25,5 h 21,5 mm
~ 11 gr - 30 pcs
Layout 6 x 5
MA1350



∅ 28 h 18 mm
~ 10 gr - 28 pcs
Layout 7 x 4
MA1521



31 x 24 h 13 mm
~ 8 gr - 35 pcs
Layout 7 x 5
MA1527



32 x 22 h 15 mm
~ 8 gr - 42 pcs
Layout 7 x 6
MA1529



∅ 26 h 19 mm
~ 9 gr - 40 pcs
Layout 8 x 5
MA1530



30 x 25 h 15 mm ~ 9 gr - 24 pcs Layout 6 x 4 **MA1604** 30 x 30 h 12 mm ~ 9 gr - 24 pcs Layout 6 x 4 **MA1606** ø 28 h 17,5 mm ~ 9 gr - 24 pcs Layout 6 x 4 **MA1607** 30 x 23 h 18 mm ~ 9 gr - 24 pcs Layout 6 x 4 **MA1609** ø 29 h 18 mm ~ 9 gr - 24 pcs Layout 6 x 4 **MA1610**



ø 30 h 15 mm ~ 9 gr - 24 pcs Layout 6 x 4 **MA1611** 38 x 30 h 15 mm ~ 9 gr - 20 pcs Layout 5 x 4 **MA1612** ø 30 h 20 mm ~ 9 gr - 24 pcs Layout 6 x 4 **MA1618** 29 x 29 h 12 mm ~ 9 gr - 18 pcs Layout 6 x 3 **MA1619** 33 x 25 h 12 mm ~ 8 gr - 24 pcs Layout 6 x 4 **MA1620**



33 x 33 h 15 mm ~ 9 gr - 24 pcs Layout 6 x 4 **MA1621** 30 x 24 h 12 mm ~ 9 gr - 24 pcs Layout 6 x 4 **MA1622** 28 x 32 h 15 mm ~ 8 gr - 32 pcs Layout 8 x 4 **MA1624** 30 x 18 h 15 mm ~ 8 gr - 30 pcs Layout 6 x 5 **MA1625** 30 x 18 h 15 mm ~ 8 gr - 30 pcs Layout 6 x 5 **MA1629**



30 x 18 h 15 mm ~ 7 gr - 30 pcs Layout 6 x 5 **MA1631** 30 x 18 h 15 mm ~ 8 gr - 30 pcs Layout 6 x 5 **MA1632** 34 x 25 h 15 mm ~ 8 gr - 30 pcs Layout 6 x 5 **MA1638** 48 x 18,5 h 19 mm ~ 9 gr - 16 pcs Layout 4 x 4 **MA1640** 21 x 21 h 18,5 mm ~ 8 gr - 28 pcs Layout 7 x 4 **MA1800**



26 x 20 h 21 mm ~ 8 gr - 28 pcs Layout 7 x 4 **MA1801** ø 23 h 18,5 mm ~ 7 gr - 28 pcs Layout 7 x 4 **MA1802** 26 x 20 h 21 mm ~ 8 gr - 28 pcs Layout 7 x 4 **MA1803** ø 25 h 18,5 mm ~ 8 gr - 28 pcs Layout 7 x 4 **MA1804** 29 x 19 h 16 mm ~ 8 gr - 28 pcs Layout 7 x 4 **MA1900**





28 x 20 h 17 mm
~ 7 gr - 28 pcs
Layout 7 x 4
MA1903



29,5 x 19 h 17 mm
~ 7 gr - 28 pcs
Layout 7 x 4
MA1907



27 x 31 h 18 mm
9,5 gr - 28 pcs
Layout 7 x 4
MA1925



ø 26 h 23 mm
~ 11 gr - 28 pcs
Layout 7 x 4
MA1927



ø 27 h 20 mm
~ 9 gr - 30 pcs
Layout 6 x 5
MA1963



ø 27 h 20 mm
~ 9 gr - 30 pcs
Layout 6 x 5
MA1964



25 x 25 h 15 mm
~ 9 gr - 30 pcs
Layout 6 x 5
MA1965



25 x 25 h 15 mm
~ 9 gr - 30 pcs
Layout 6 x 5
MA1966



25 x 25 h 15 mm
~ 9 gr - 30 pcs
Layout 6 x 5
MA1968

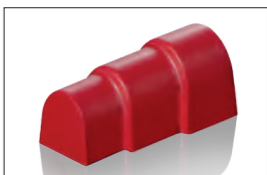

40 x 20 h 18 mm
~ 8 gr - Prod. 30 pcs
Layout 10 x 3
MA1969

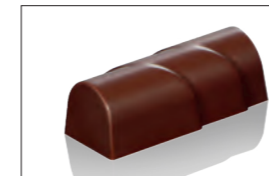

40 x 18 h 15 mm
~ 9 gr - 30 pcs
Layout 10 x 3
MA1970



40 x 18 h 16 mm
~ 8 gr - 30 pcs
Layout 10 x 3
MA1971



26 x 26 h 20 mm
~ 7 gr - 30 pcs
Layout 6 x 5
MA1972



25 x 25 h 13 mm
~ 9 gr - 24 pcs
Layout 6 x 4
MA1980



ø 35 h 15 mm
~ 10 gr - 24 pcs
Layout 6 x 4
MA1981



28 x 28 h 16 mm
~ 11 gr - 28 pcs
Layout 7 x 4
MA1982



24 x 24 h 18 mm
~ 10 gr - 28 pcs
Layout 7 x 4
MA1983



41 x 24 h 20 mm
~ 10 gr - 20 pcs
Layout 5 x 4
MA1985



30 x 30 h 11 mm
~ 11 gr - 28 pcs
Layout 7 x 4
MA1986



35 x 23 h 17 mm
~ 10 gr - 24 pcs
Layout 6 x 4
MA1987



30 x 30 h 8 mm
~ 8 gr - 24 pcs
Layout 6 x 4
MA1988



ø 35 h 8 mm
~ 8 gr - 24 pcs
Layout 6 x 4
MA1989



20 x 20 h 16 mm
~ 6 gr - 28 pcs
Layout 7 x 4
MA2003



26 x 26 h 12 mm
~ 8,5 gr - 28 pcs
Layout 7 x 4
MA3007

TRIDIMENSIONAL/TRIDIMENSIONALI



For artisanal production. The kit includes: 3D mould and plate to remove excess chocolate.
 Per produzione artigianale. Il kit include: stampo 3D e placca per togliere il cioccolato in eccesso.

Sphere

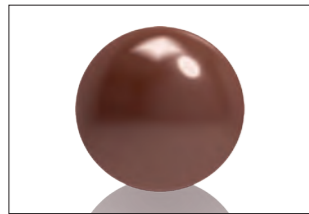

26 x 26 h 26 mm
 ~ 8 gr - 28 pcs
 Layout 7 x 4

20-3D2001

Egg



23 x 32 h 23 mm
 ~ 8 gr - 28 pcs
 Layout 7 x 4

20-3D1002

Apple



ø 28 h 27 mm
 ~ 12 gr - 28 pcs
 Layout 7 x 4

20FRUIT01



Pear



ø 26 h 36 mm
 ~ 12 gr - 28 pcs
 Layout 7 x 4

20FRUIT02

Strawberry



ø 28 h 32 mm
 ~ 12 gr - 28 pcs
 Layout 7 x 4

20FRUIT03

Lemon



ø 25 h 31 mm
 ~ 12 gr - 28 pcs
 Layout 7 x 4

20FRUIT04

Orange



ø 27 h 30 mm
 ~ 12 gr - 28 pcs
 Layout 7 x 4

20FRUIT05

Professional chocolate mould
 Stampi professionali per cioccolato
 275 x 175 mm



Ideal for praline production with dispensing machine **[ONE SHOT]**
 Ideali per la produzione di praline con macchine dosatrici



Heart



30 x 28 h 19 mm
 ~ 11 gr - Prod. 28 pcs
 Layout 7 x 4

203D03

Egg



ø 23,5 h 32 mm
 ~ 10 gr - Prod. 28 pcs
 Layout 7 x 4

203D04

Truffle 26



ø 26 h 24 mm
 ~ 10 gr - Prod. 28 pcs
 Layout 7 x 4

203D01

Truffle 23



ø 23 h 20,6 mm
 ~ 7 gr - Prod. 28 pcs
 Layout 7 x 4

203D02

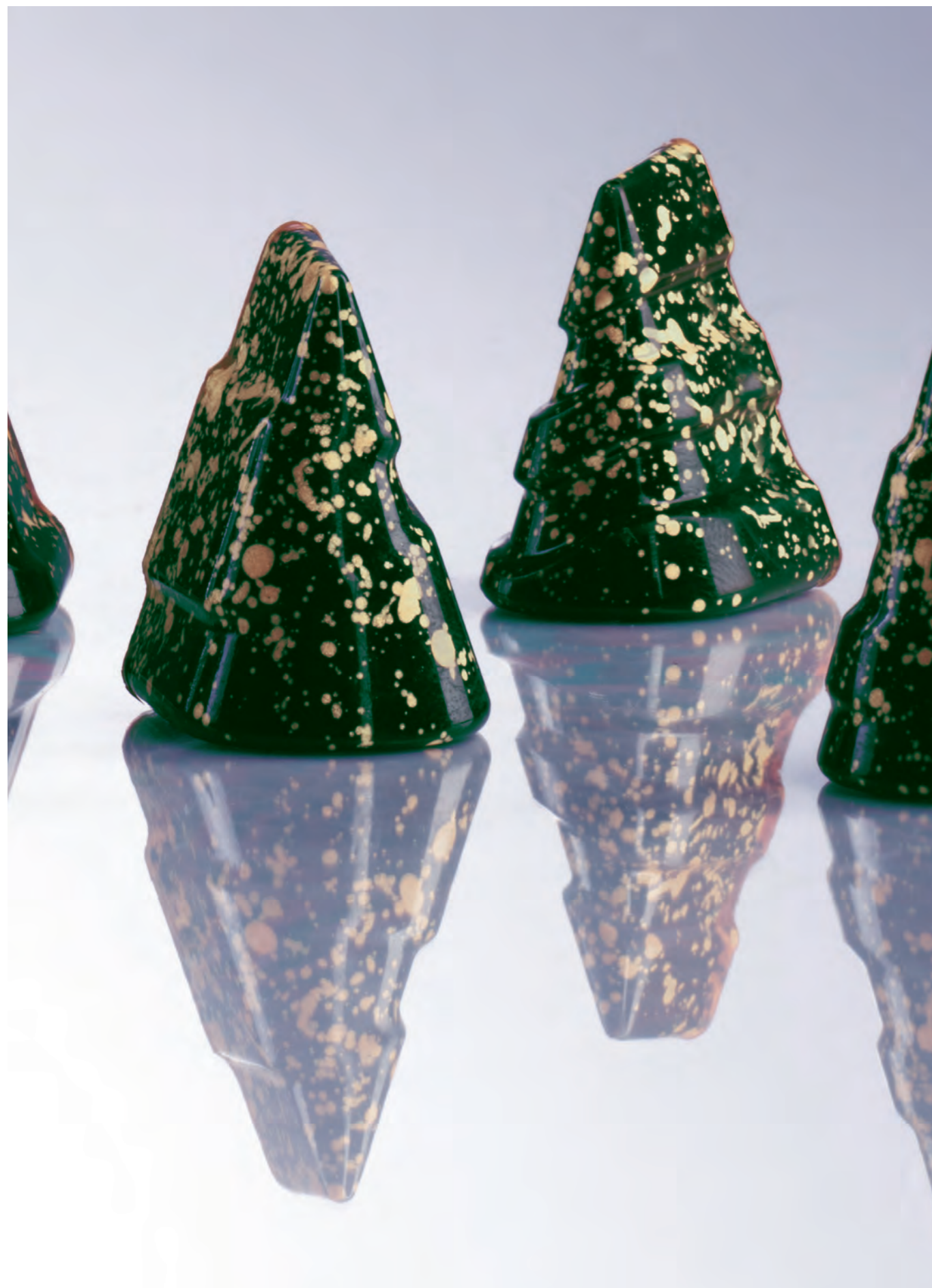

CHRISTMAS/NATALE

Professional chocolate mould
Stampi professionali per cioccolato
 275 x 175 mm

Gift



26 x 26 h 20 mm
 Weight ~ 11 gr - Prod. 28 pcs
 Layout 7 x 4

MA1991

Pandorino



ø 30 h 25 mm
 Weight ~ 10 gr - Prod. 24 pcs
 Layout 6 x 4

MA1990

Spheres



30 x 26 h 16,5 mm
 Weight ~ 7 gr - Prod. 30 pcs
 Layout 6 x 5

MA1974

Trees



31 x 22 h 22 mm
 Weight ~ 7 gr - Prod. 30 pcs
 Layout 6 x 5

MA1975



Star

40 x 42 h 16 mm
 Weight ~ 10 gr - Prod. 15 pcs
 Layout 5 x 3
 Professional mould 275 x 175 mm

MA1984



Small Bottle

60 x 20,5 h 16 mm
 Weight ~ 12 gr - Prod. 18 pcs
 Layout 9 x 2
 Professional mould 275 x 175 mm

MA3011

VALENTINE'S & MUM'S DAY

SAN VALENTINO E FESTA DELLA MAMMA



Diamond

33 x 33 h 15 mm
Weight ~ 10 gr - Prod. 24 pcs
Layout 6 x 4
Professional mould 275 x 175 mm

MA1993

Professional chocolate mould
Stampi professionali per cioccolato
275 x 175 mm



Weave

34 x 33 h 11 mm
Weight ~ 7 gr - Prod. 28 pcs
Layout 7 x 4

MA1513



Intense

40 x 42 h 15 mm
Weight ~ 9 gr - Prod. 15 pcs
Layout 5 x 3

MA1613



Braid

31 x 27 h 14 mm
Weight ~ 8 gr - Prod. 30 pcs
Layout 6 x 5

MA1962



Smoothy

30,5 x 28 h 16,5 mm
Weight ~ 8 gr - Prod. 35 pcs
Layout 7 x 5

MA1526



FATHER'S DAY/FESTA DEL PAPÀ

Professional chocolate mould
Stampi professionali per cioccolato
275 x 175 mm



Snapback

82 x 59 x 37 mm
Weight ~ 45 gr - Prod. 6 pcs
Layout 3 x 2

MA7003



Dafne

ø 35 h 16 mm
Weight ~ 11 gr - Prod. 24 pcs
Layout 6 x 4
Professional mould 275 x 175 mm

MA1055



Bolt

31 x 27 h 16 mm
Weight ~ 11 gr - Prod. 24 pcs
Layout 6 x 4

MA1054



Deep Heart

27 x 27 h 16 mm
Weight ~ 11 gr - Prod. 28 pcs
Layout 7 x 4
Professional mould 275 x 175 mm

MA1056



Joe

16 x 54 h 16 mm
Weight ~ 10 gr - Prod. 16 pcs
Layout 4 x 4

MA1053

HALLOWEEN DAY/HALLOWEEN

Professional chocolate mould
Stampi professionali per cioccolato
275 x 175 mm



New

Whisky

34 x 26 h 17 mm
Weight ~ 8,6 gr - Prod. 20 pcs
Layout 5 x 4

MA1031



Skull

37 x 28 h 18 mm
Weight ~ 10 gr - Prod. 20 pcs
Layout 5 x 4

MA1017



Pumpkin

34 x 31 h 15 mm
Weight ~ 9 gr - Prod. 24 pcs
Layout 6 x 4

MA1992



New

Spooky

34 x 32,5 h 17 mm
Weight ~ 9,3 gr - Prod. 20 pcs
Layout 5 x 4

MA1061

BARS

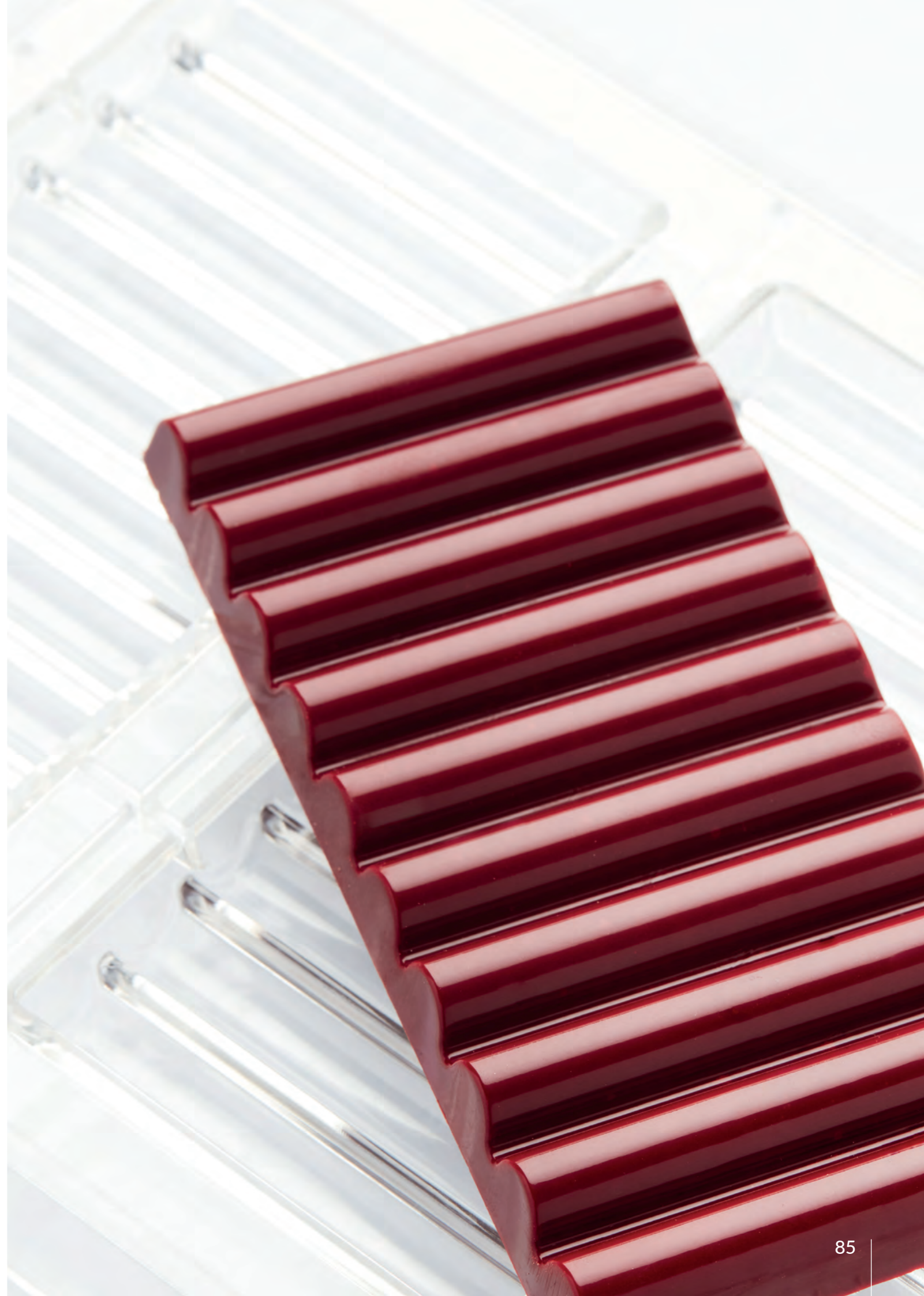



Peak

142 x 68 h 12 mm
 Weight ~ 100 gr - Prod. 3 pcs
 Layout 3 x 1
 Professional mould 275 x 175 mm

MA2027



Swing

142 x 68 h 10,5 mm
 Weight ~ 98 gr - Prod. 3 pcs
 Layout 3 x 1
 Professional mould 275 x 175 mm

MA2028



Weave

140 x 70 h 11 mm
 Weight ~ 100 gr - Prod. 3 pcs
 Layout 3 x 1
 Professional mould 275 x 175 mm

MA2029



Pyramid

138 x 72 h 11 mm
 Weight ~ 80 gr - Prod. 3 pcs
 Layout 3 x 1
 Professional mould 275 x 175 mm

MA2009



Mirror

138 x 72 h 9 mm
 Weight ~ 86 gr - Prod. 3 pcs
 Layout 3 x 1
 Professional mould 275 x 175 mm

MA2022

Kit

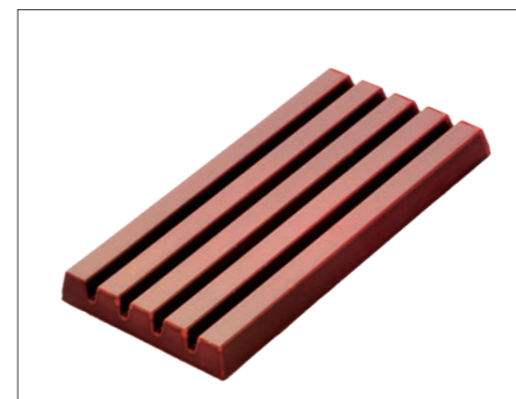

138 x 68 h 11 mm
 Weight ~ 103 gr - Prod. 3 pcs
 Layout 3 x 1
 Professional mould 275 x 175 mm

MA2023

Log



140 x 69,5 h 11 mm
 Weight ~ 98 gr - Prod. 3 pcs
 Layout 3 x 1
 Professional mould 275 x 175 mm

MA2024

Slot



140 x 70,5 h 10 mm
 Weight ~ 102 gr - Prod. 3 pcs
 Layout 3 x 1
 Professional mould 275 x 175 mm

MA2026

Block



139 x 69,5 h 11,5 mm
 Weight ~ 102 gr - Prod. 3 pcs
 Layout 3 x 1
 Professional mould 275 x 175 mm

MA2025



Mini Quilted

133 x 70 x h 10 mm
 Weight ~ 82 gr - Prod. 3 pcs
 Layout 3 x 1
 Professional mould
 275 x 175 mm

MA2020



Quilted

132 x 66 h 10 mm
 Weight ~ 80 gr - Prod. 3 pcs
 Layout 3 x 1
 Professional mould
 275 x 175 mm

MA2021

Stone



70 x 70 h 11 mm
 Weight ~ 50 gr - Prod. 6 pcs
 Layout 3 x 2
 Professional mould
 275 x 175 mm

MA2013

Square



70 x 70 h 11 mm
 Weight ~ 50 gr - Prod. 6 pcs
 Layout 3 x 2
 Professional mould
 275 x 175 mm

MA2014

Hexagon



140 x 68,5 h 13,5 mm
 Weight ~ 100 gr - Prod. 3 pcs
 Layout 3 x 1
 Professional mould
 275 x 175 mm

MA2015

Kaleidos



130 x 75 x 9 mm
 Weight ~ 85 gr - Prod. 3 pcs
 Layout 3 x 1
 Professional mould
 275 x 175 mm

MA2019

Liquid

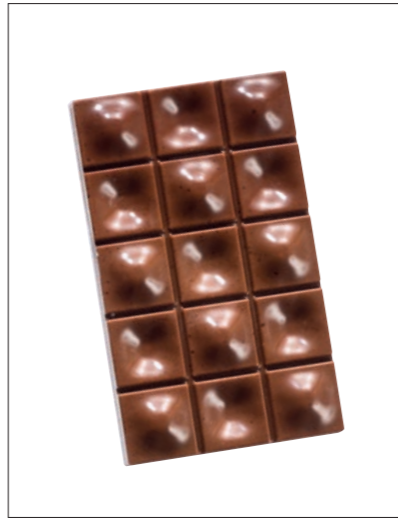

117 x 71 h 13 mm
 Weight ~ 80 gr - Prod. 3 pcs
 Layout 3 x 1
 Professional mould
 275 x 175 mm

MA2008

Tablet



130 x 70 h 8 mm
 Weight ~ 83 gr - Prod. 3 pcs
 Layout 3 x 1
 Professional mould
 275 x 175 mm

MA2012



City

150 x 76 h 7 mm
 Weight ~ 80 gr - Prod. 3 pcs
 Layout 3 x 1
 Professional mould 275 x 175 mm

MA2011

Professional chocolate mould
Stampi professionali per cioccolato
 275 x 175 mm

Bubble

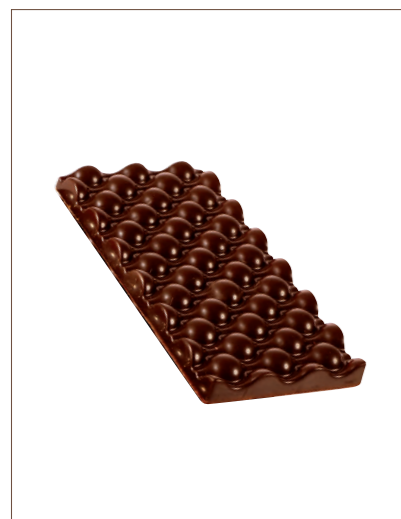

132 x 68 h 11 mm
 Weight ~ 80 gr
 Prod. 3 pcs - Layout 3 x 1

MA2010

Classic 70



150 x 70 h 11 mm
 Weight ~ 110 gr
 Prod. 3 pcs - Layout 3 x 1

MA2000

Kube



137 x 72 h 10 mm
 Weight ~ 100 gr
 Prod. 3 pcs - Layout 3 x 1

MA2016

Classic 75



160 x 75 h 8 mm
 Weight ~ 110 gr
 Prod. 3 pcs - Layout 3 x 1

MA2001

Classic 78



157 x 78 h 7 mm
 Weight ~ 65 gr
 Prod. 3 pcs - Layout 3 x 1

MA2005

Love



137 x 71 h 9,5 mm
 Weight ~ 100 gr
 Prod. 3 pcs - Layout 3 x 1

MA2017

LIGHT CHOCOBARS

Thermoformed moulds
Stampi termoformati



150 x 70 h10mm
 Weight ~100 gr - Pack 5 pcs

20TC001



150 x 70 h10mm
 Weight ~100 gr - Pack 5 pcs

20TC002



150 x 70 h10mm
 Weight ~100 gr - Pack 5 pcs

20TC003



150 x 70 h 8 mm
 Weight ~100 gr - Pack 5 pcs

20TC004



130 x 55 h 8 mm
 Weight ~70 gr - Pack 5 pcs

20TC005



110 x 50 h 8 mm
 Weight ~45 gr - Pack 5 pcs

20TC006

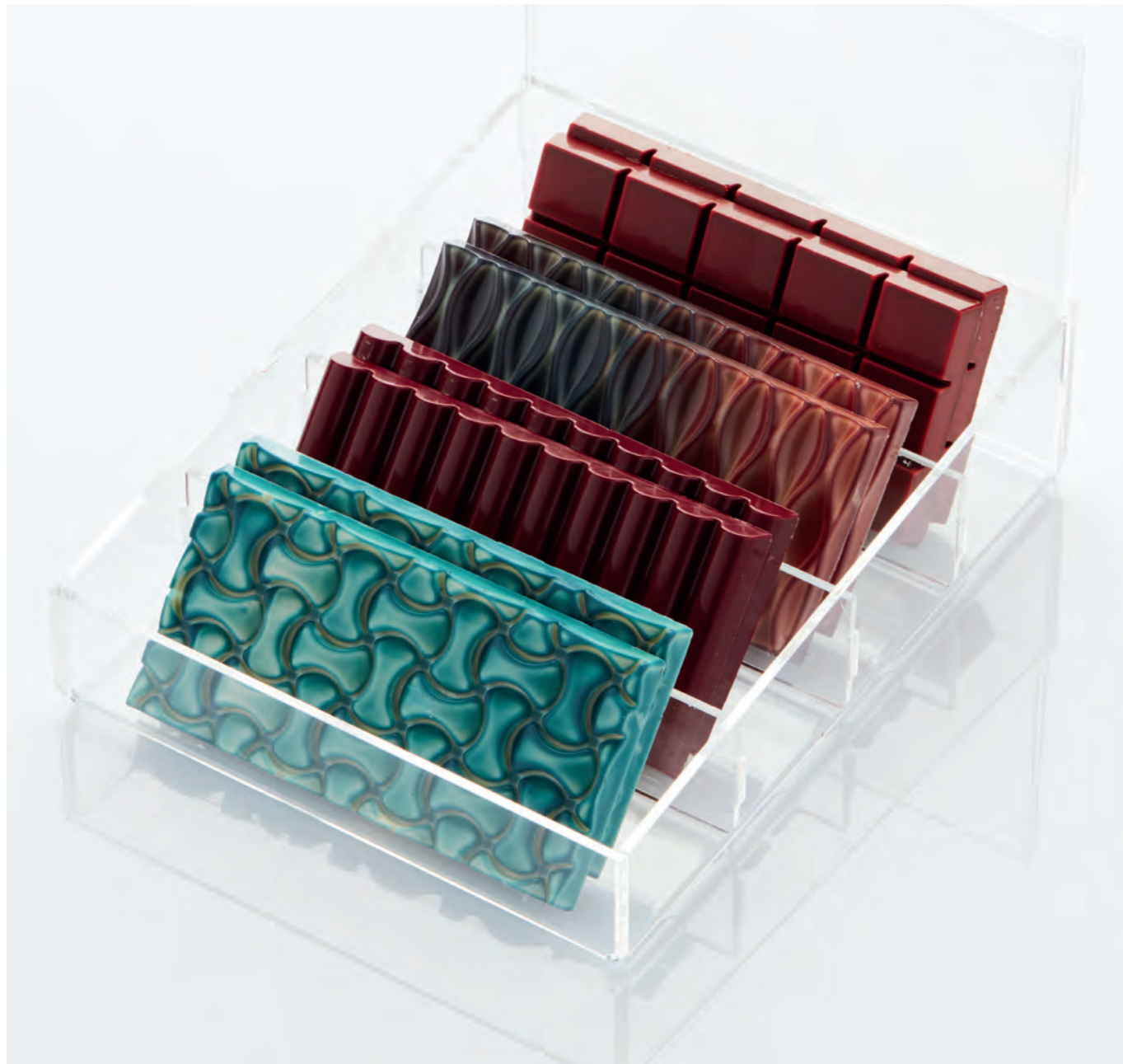

Horizontal

181 x 226 h 43/156 mm
Cap. ~ 16 pcs (standing)/
~ 32 pcs (laying) - Plexiglass

With removable pocket to
insert customized graphics/
con taschina removibile
per inserire grafica
personalizzata

80ET008

CHOCOLATE DISPLAYS/ESPOSITORI PER CIOCCOLATO

Vertical



91 x 226 h 73/93 mm
Cap. ~ 16 pcs
Plexiglass

80ET007

Double



180 x 220 h 255 mm
Cap. ~ 16 pcs (standing)/
~ 32 pcs (laying) - Plexiglass

80ET009

Classic

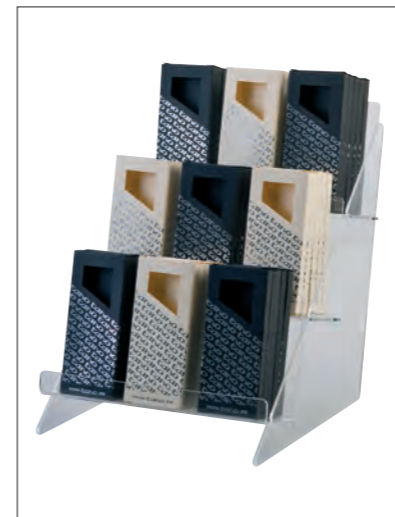

245 x 300 h 290 mm
Cap. ~ 45 pcs
Plexiglass

ET004

Traditional



315 x 410 h 370 mm
Cap. ~ 80 pcs
Plexiglass

ET004B

SNACKS



CLASSIC/CLASSICI

Professional chocolate mould
 Stampi professionali per cioccolato
 275 x 175 mm



Liquid

100 x 26 h 16 mm
 Weight ~ 30 gr
 Prod. 8 pcs
 Layout 2 x 4

MA1914



Pyramid

123 x 27 h 12 mm
 Weight ~ 30 gr
 Prod. 8 pcs
 Layout 2 x 4

MA1915



Stairs

100 x 29 h 14 mm
 Weight ~ 30 gr
 Prod. 8 pcs
 Layout 2 x 4

MA1916





Modern Bon

86,5 x 31,5 h 18 mm
 Weight ~ 34,5 gr - Prod. 8 pcs
 Layout 2 x 4
 Professional mould 275 x 175 mm

MA1924

Professional chocolate mould
Stampi professionali per cioccolato
 275 x 175 mm

Curvy



96 x 22 h 17 mm
 Weight ~ 34 gr - Prod. 10 pcs
 Layout 2 x 5
 Professional mould 275 x 175 mm

MA1920

Triangle



96 x 22 h 17 mm
 Weight ~ 23 gr - Prod. 10 pcs
 Layout 2 x 5
 Professional mould 275 x 175 mm

MA1922

Plain



96 x 22 h 15,5 mm
 Weight ~ 34 gr - Prod. 10 pcs
 Layout 2 x 5
 Professional mould 275 x 175 mm

MA1921

Classic Bon



90 x 31 h 16,5 mm
 Weight ~ 30 gr - Prod. 8 pcs
 Layout 2 x 4
 Professional mould 275 x 175 mm

MA1926

Professional chocolate mould
 Stampi professionali per cioccolato
 275 x 175 mm



City

113 x 39 h 10 mm
 Weight ~ 45 gr - Prod. 6 pcs
 Layout 2 x 3

MA1919



Choco

120 x 24 h 11 mm
 Weight ~ 33 gr - Prod. 8 pcs
 Layout 2 x 4

MA1923



Brick

81 x 27 h 15 mm
 Weight ~ 30 gr - Prod. 12 pcs
 Layout 3 x 4

MA1918





SHARING SNACK/SNACK DA CONDIVIDERE

Professional chocolate mould
 Stampi professionali per cioccolato
 275 x 175 mm

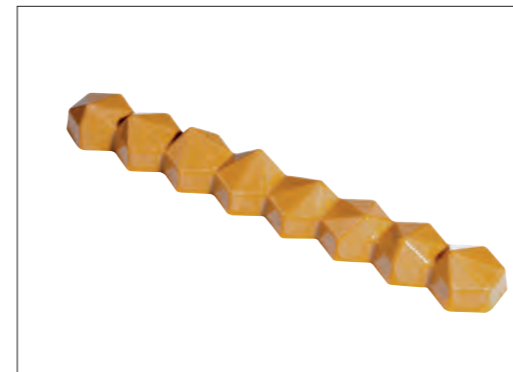

Prisma XL

202 x 32 h 19 mm
 Weight ~ 70 gr - Prod. 4 pcs
 Layout 1 x 4

MA7002

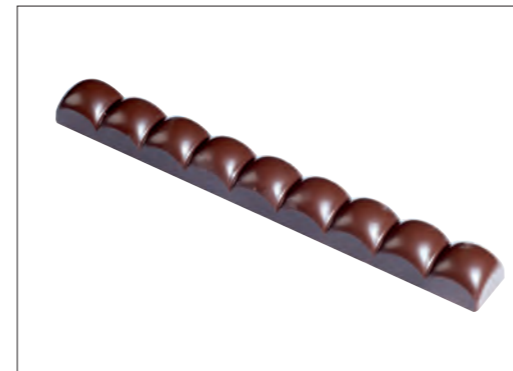

Bubble XL

200 x 23 h 17 mm
 Weight ~ 70 gr - Prod. 4 pcs
 Layout 1 x 4

MA7001



Kite XL

200 x 23 h 18 mm
 Weight ~ 62 gr - Prod. 4 pcs
 Layout 1 x 4

MA7000

Professional chocolate mould
Stampi professionali per cioccolato
 275 x 175 mm



Flat

198 x 35 h 23 mm
 Weight ~ 160 gr - Prod. 4 pcs
 Layout 1 x 4

MA6100



Round

198 x 35 h 23 mm
 Weight ~ 150 gr - Prod. 4 pcs
 Layout 1 x 4

MA6101



Curvy

198 x 35 h 23 mm
 Weight ~ 150 gr - Prod. 4 pcs
 Layout 1 x 4

MA6102



Wavy

198 x 35 h 23 mm
 Weight ~ 150 gr - Prod. 4 pcs
 Layout 1 x 4

MA6103



FIGURES





CHRISTMAS/NATALE TREES/ALBERI

Professional chocolate mould
Stampi professionali per cioccolato
275 x 175 mm



New

Chiffon

120 x 123 h 150 mm
Weight ~ 250 gr - Prod. 1 pc
Layout 2 x 1
Professional mould 275 x 175 mm

MA3017



Treesmas

ø 75 h 120 mm
Weight ~ 95 gr - Prod. 2 pcs
Professional mould 275 x 175 mm

MA3009



Diamond Tree

ø 104 h 180 mm
Weight ~ 250 gr - Prod. 1 pc
Professional mould 275 x 175 mm

MA3012



Professional moulds/stampi
275 x 175 mm



Merry Christmas **New**

154 x 151 h 184 mm
Weight ~ 500 gr - Prod. 1 pc

20SR108 - Mould for artisanal production
Stampi per produzione artigianale

20SR108A - Mould for rotating machines
Stampi per rotativa



Professional moulds/stampi
275 x 175 mm



Hula Tree

ø 110 h 152 mm
Weight ~ 200 gr - Prod. 2 pcs

20SR100 - Mould for artisanal production
Stampi per produzione artigianale

20SR100A - Mould for rotating machines
Stampi per rotativa



Thermoformed plastic moulds
Stampi in plastica termoformata



Modular Trees

ø 150 h 180 mm ~290 gr
Prod. 2 pcs

20CT01



Christmas Tree

ø 95 h 120 mm
~100 gr - Prod. 4 pcs

20A3D02

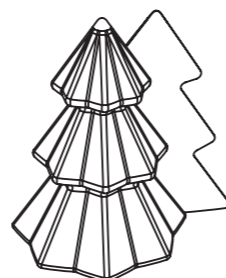

Xmas Tree

ø 112 h 180 mm
~170 gr - Prod. 2 pcs

20A3D01

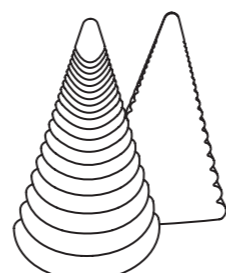

Cone shape mould with star decoration mat included
Stampo a forma di cono più tappetino per decorazione stella incluso

Big Tree

ø 123 h 205 mm
~ 300 gr - Prod. 2 pcs

20CO02

Small Tree

ø 83 h 140 mm
~140 gr - Prod. 4 pcs

20CO01





XMAS BAUBLES/PALLE DI NATALE

Professional chocolate mould
 Stampi professionali per cioccolato
 275 x 175 mm



Diamantine

ø 62 h 72 mm
 Weight ~ 50 gr - Prod. 6 pcs - Layout 3 x 2

20SR103 - Mould for artisanal production
 Stampi per produzione artigianale

20SR103A - Mould for rotating machines
 Stampi per rotativa



Snow New

ø 60 h 72 mm
 Weight ~ 47 gr - Prod. 6 pcs - Layout 3 x 2

20SR104 - Mould for artisanal production
 Stampi per produzione artigianale

20SR104A - Mould for rotating machines
 Stampi per rotativa



Classic New

ø 60 h 72 mm
 Weight ~ 47 gr - Prod. 6 pcs - Layout 3 x 2

20SR105 - Mould for artisanal production
 Stampi per produzione artigianale

20SR105A - Mould for rotating machines
 Stampi per rotativa



Thermoformed plastic moulds
Stampi in plastica termoformata

Bond



ø 60 mm - Weight ~ 40 gr
Prod. 12 half baubles
2 moulds - Layout 3 x 2

20SF003

Diamond



ø 60 mm - Weight ~ 40 gr
Prod. 12 half baubles
2 moulds - Layout 3 x 2

20SF005



Cometa



ø 60 mm ~ Weight ~ 40 gr
Prod. 12 half baubles
2 moulds - Layout 3 x 2

20SF006

Star



62 x 69 mm - Weight ~ 26 gr
Prod. 12 half baubles
2 moulds - Layout 3 x 2

20SF008

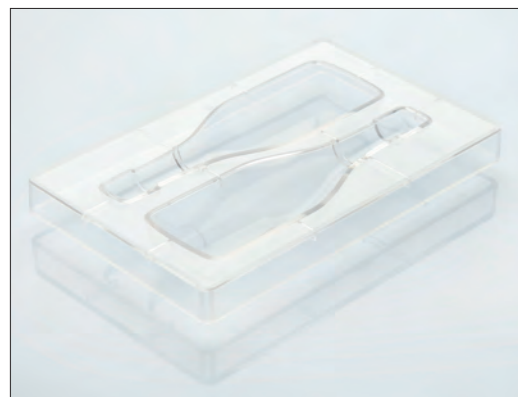

Bottle

ø 65,4 h 220 mm
 closer/tappo ø 26,8 mm
 Weight ~ 120 gr - Prod. 1 pc
 Professional mould 275 x 175 mm

MA3010





BEARS/ORSETTI

Professional chocolate mould
Stampi professionali per cioccolato
275 x 175 mm

Surprise Bear **New**



63 x 54 h 101 mm
Weight ~ 74 gr - Prod. 4+4 pcs
Each pack contains 2 moulds.
Ogni confezione contiene 2 stampi.

20SR106 - 2 moulds for artisanal production with hooks
2 stampi per produzione artigianale con ganci

20SR106A - 2 moulds for rotating machines with hooks
2 stampi per rotativa con ganci

Cuddly Bear **New**



67 x 54 h 105 mm
Weight ~ 90 gr - Prod. 4+4 pcs
Each pack contains 2 moulds.
Ogni confezione contiene 2 stampi.

20SR107 - 2 moulds for artisanal production with hooks
2 stampi per produzione artigianale con ganci

20SR107A - 2 moulds for rotating machines with hooks
2 stampi per rotativa con ganci



Teddy

97 x 64 h 130 mm
Weight ~ 110 gr - Prod. 1 pc
Layout 2 x 1

MA3014

SANTA CLAUS/BABBO NATALE



Santa

ø 70 h 120 mm
 Weight ~ 55 gr - Prod. 2 pcs
 Professional mould 275 x 175 mm

MA3008



Diamond Santa

68 x 61 h 130 mm
 Weight ~ 90 gr - Prod. 2 pcs
 Professional mould 275 x 175 mm

MA3013



Santa & Snowman

Santa Claus: ø 46 h 79 mm
 Snowman: 42 x 46 h 72 mm
 Prod. 4+4 pcs
 Professional mould 275 x 175 mm



20-C1010

Santa & teddy



h 168 mm -Prod. 1 pc
 Thermoformed mould

MAC170S

Santa & fawn



h 180 mm -Prod. 1 pc
 Thermoformed

MAC140S



Big Boot



h 135 mm - Prod. 1 pc
 Thermoformed mould

MAC421S

Toy Soldier



40 x 34 h 150 mm
 Weight ~ 80 gr Prod. 1 pc
 Thermoformed mould

MAC407S

Snowman little



h 114 mm - Prod. 3 pcs
 Thermoformed mould

MAC320S



Sir Toy

53 x 44 h 120 mm
Weight ~ 65 gr - Prod. 4 pcs

20SR102 - Mould for artisanal production
Stampi per produzione artigianale

20SR102A - Mould for rotating machines
Stampi per rotativa



Rudolph

88 x 56 h 120 mm
Weight ~ 70 gr - Prod. 2 pcs

20SR101 - Mould for artisanal production
Stampi per produzione artigianale

20SR101A - Mould for rotating machines
Stampi per rotativa



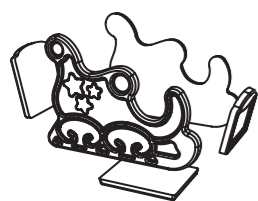

Xmas Sledge

140 x 70 h 100 mm
 Weight ~ 140 gr - Prod. 2 pcs
 2 Thermoformed mould

20SL01

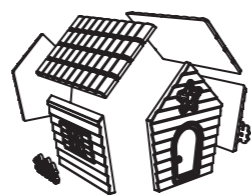

Sweet Home

108 x 116 h 118 mm
 Weight ~ 280 gr - Prod. 2 pcs
 4 Thermoformed mould

20HO01



Chocolate Gift

80 x 80 h 69 mm
 Weight ~ 80 gr - Prod. 2 pcs
 2 Thermoformed moulds

20PR01

HALLOWEEN



New

Amleto

96 x 75 h 100 mm
 Weight ~ 137 gr - Prod. 2 pcs
 Layout 2 x 2
 Professional mould 275 x 175 mm

MA3018



3D Pumpkin

52 x 54 h 132 mm
 Weight ~ 140 gr - Prod. 1 pc
 Thermoformed plastic mould

MAC324S



Mr Pumpkin

39 x 42 h 102 mm
 Weight ~ 40 gr - Prod. 1 pc
 Thermoformed plastic mould

MAC406S



EASTER/PASQUA



ELEGANT SHAPES FOR A GLAMOROUS EASTER

Created thanks to the aesthetic taste of Philip Khoury, Head Pastry for Harrods, the Blossom egg joins the wide range of chocolate moulds in Martellato's Supreme line. A unique design that confers elegance and modernity, to meet the needs of those who wish to amaze with a fascinating product that respects tradition.

Realizzato grazie al gusto estetico di Philip Khoury, Head Pastry per Harrods, l'uovo Blossom si aggiunge all'ampia gamma di stampi per cioccolato della linea Supreme di Martellato. Un design unico che conferisce eleganza e modernità, per soddisfare le esigenze di chi desidera stupire con un prodotto affascinante ma che rispetti la tradizione.



New
Blossom
signed by Philip Khoury

ø 105 h 165 mm
Weight ~ 200 gr - Prod. 1 egg/uovo
Layout 2 x 1 - BPA free
Professional mould 275 x 175 mm
base not included/base non inclusa

21U505



A CHOCOLATE EGG FOR A GREENER WORLD

A mould designed with great attention to detail with a unique and special shape: Cocoa is the egg that Martellato has created in collaboration with Alberto Simionato, director of Chocolate Academy Milano. What makes this mould even more special is its noble cause, in fact part of the proceeds will be used to expand the Martellato forest, created thanks to Treadom. Scan the qr code to find out more.

Uno stampo disegnato con grande cura per i dettagli dalla forma unica e speciale: Cocoa è l'uovo che Martellato ha creato in collaborazione con Alberto Simionato, direttore di Chocolate Academy Milano. Ciò che rende ancora più speciale questo stampo è la sua nobile causa, infatti parte del ricavato verrà utilizzato per ampliare la foresta Martellato creata grazie a Treadom. Scansiona il qr code per saperne di più.



New

Cocoa

signed by Alberto Simionato



ø 93,5 h 165 mm
Weight ~ 275 gr - Prod. 1 egg/uovo
Layout 2 x 1 - BPA free
Professional mould 275 x 175 mm
base not included/base non inclusa

21U506



Professional chocolate mould
 Stampi professionali per cioccolato
 275 x 175 mm



Happy Easter

ø 156 h 228 mm
 Prod. 1 egg/uovo ~ 330 gr
 base not included/base non inclusa

20SR022 - Mould for artisanal production
 Stampi per produzione artigianale

20SR022A - Mould for rotating machines
 Stampi per rotativa



Crack

ø 100 h 150 mm
 Prod. 2 eggs/uova ~ 160 gr
 base not included/base non inclusa

20SR021 - Mould for artisanal production
 Stampi per produzione artigianale

20SR021A - Mould for rotating machines
 Stampi per rotativa



Suave

ø 113 h 150 mm
 Prod. 2 eggs/uova ~ 220 gr
 base not included/base non inclusa

20SR020 - Mould for artisanal production
 Stampi per produzione artigianale

20SR020A - Mould for rotating machines
 Stampi per rotativa





Professional chocolate mould
 Stampi professionali per cioccolato
 275 x 175 mm



Bond

ø 101 h 150 mm
 Weight ~ 210 gr - Prod. 1 egg/uovo
 Layout 2 x 1

20U504



Diamond

ø 99 h 150 mm
 Weight ~ 210 gr - Prod. 1 egg/uovo
 Layout 2 x 1

20U502

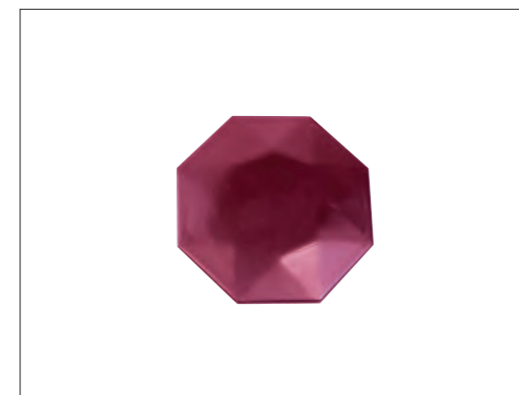

Diamond Base

68 x 68 h 5,5 mm
 Weight ~ 16 gr - Prod. 6 pcs
 Layout 3 x 2

20U503



Drip

ø 100 h 150 mm
 Weight ~ 210 gr - Prod. 1 egg/uovo
 Layout 2 x 1
 Professional mould 275 x 175 mm

20U501



Puzzle

ø 105 h 150 mm
 Weight ~ 210 gr - Prod. 1 egg/uovo
 Layout 2 x 1
 Professional mould 275 x 175 mm

20U500



Diamond

ø 120 h 185 mm
 Weight ~ 280 gr - Prod. 2 eggs/uova
 Thermoformed moulds - base included/inclusa

20U3D07



Globe

ø 125 h 185 mm
 Weight ~ 280 gr - Prod. 2 eggs/uova
 Thermoformed moulds - base included/inclusa

20U3D08

Thermoformed plastic moulds included base
Stampi in plastica termoformata con base inclusa

Stretch



ø 110 h 220 mm
 Weight ~ 230 gr - 2 moulds
 Prod. 2 eggs/uova

20U3D01

Wave



ø 115 h 185 mm
 Weight ~ 320 gr - 2 moulds
 Prod. 2 eggs/uova

20U3D02

Penta



ø 120 h 185 mm
 Weight ~ 300 gr - 2 moulds
 Prod. 2 eggs/uova

20U3D03

Honey



ø 122 h 185 mm
 Weight ~ 270 gr - 2 moulds
 Prod. 2 eggs/uova

20U3D04

Curvy



ø 115 h 185 mm
 Weight ~ 258 gr - 2 moulds
 Prod. 2 eggs/uova

20U3D05

Capitonné



ø 115 h 155 mm
 Weight ~ 230 gr - 2 moulds
 Prod. 2 eggs/uova

20U3D06





SMOOTH EGGS/UOVA LISCE

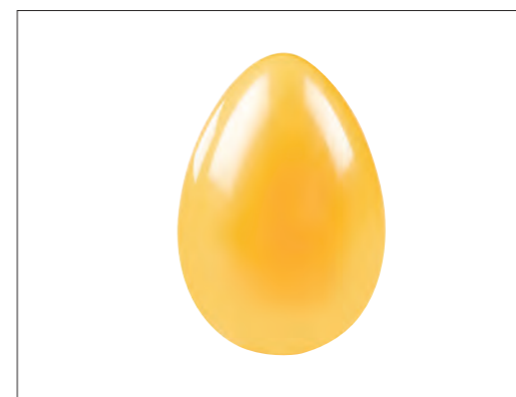

Egg 15

ø 104 h 150 mm
Weight ~ 230 gr - Prod. 2 eggs/uova
Professional mould 275 x 175 mm

20SR001 - Mould for artisanal production
Stampi per produzione artigianale

20SR001A - Mould for rotating machines
Stampi per rotativa

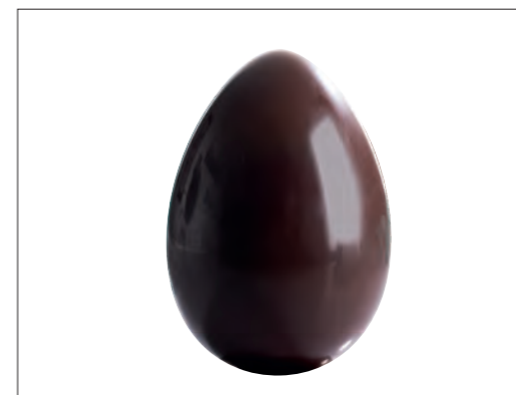

Egg 17

ø 120 h 175 mm
Weight ~ 260 gr - Prod. 1 egg/uovo
Professional mould 275 x 175 mm

20SR003 - Mould for artisanal production
Stampi per produzione artigianale

20SR003A - Mould for rotating machines
Stampi per rotativa



Egg 20

ø 141 h 204 mm
Weight ~ 380 gr - Prod. 1 egg/uovo
Professional mould 275 x 175 mm

20SR002 - Mould for artisanal production
Stampi per produzione artigianale

20SR002A - Mould for rotating machines
Stampi per rotativa



Egg 23

ø 160 h 230 mm
Weight ~ 430 gr - Prod. 1 egg/uovo
Professional mould 275 x 175 mm

20SR004 - Mould for artisanal production
Stampi per produzione artigianale

20SR004A - Mould for rotating machines
Stampi per rotativa

SMOOTH HALF EGGS/MEZZE UOVA LISCE

Professional chocolate mould
Stampi professionali per cioccolato



Cod.	Size (mm)	Mould (mm)	Prod.	Egg weight
20U032N	22 x 32	275 x 175	16 eggs	7 gr
20U064N	44 x 64	275 x 175	5 eggs	25 gr
20U105N	72 x 105	275 x 175	2 eggs	70 gr
20U130N	90 x 130	275 x 175	1 egg	150 gr
20U150N	104 x 150	275 x 175	1 egg	230 gr
20U175N	121 x 175	275 x 175	1/2 egg	260 gr
20U204N	141 x 204	275 x 175	1/2 egg	380 gr
20U227N	157 x 227	275 x 175	1/2 egg	430 gr

Cod.	Size (mm)	Mould (mm)	Prod.	Egg weight
20U258	258 x 175	365 x 200	1/2 egg	500 gr
20U320	320 x 210	365 x 275	1/2 egg	850 gr

Cod.	Size (cm)	Egg weight
SUT25X17	250 x 170	0,5 - 1 kg
SUT28X18	280 x 185	0,8 - 1,2 kg
SUT34X25	325 x 240	1,5 - 2 kg
SUT40X27	390 x 265	2 - 2,5 kg
SUT45X32	435 x 310	2,5 - 3,5 kg
SUT54X36	520 x 350	4 - 6 kg
SUT64X43	620 x 420	6 - 8 kg
SUT75X50	740 x 490	8 - 10 kg

Rigid thermoformed mould.
Stampo termoformato rigido.



Thermoformed plastic mould
Stampo in plastica termoformata

Cod.	Size (mm)	Prod.	Half egg weight
SM 2000	110 x 80 h 40	2 half eggs	55 gr
SM 2500	140 x 100 h 50	2 half eggs	60 gr
SM 3000	125 x 94 h 44	2 half eggs	80 gr
SM 3500	154 x 110 h 55	2 half eggs	90 gr



Thermoformed plastic mould
Stampo in plastica termoformata

Cod.	Size (mm)	Prod.	Half egg weight
SM 2300	112 x 83 h 44	1/2 egg x 2 moulds	50 gr
SM 4000	220 x 160 h 85	1/2 egg	170 gr



Thermoformed plastic mould
Stampo in plastica termoformata

Cod.	Size (mm)	Prod.	Half egg weight
SM 1000	80 x 60 h 25 mm	4 half eggs	25 gr

Pack 3 thermoformed moulds (3 sizes)
Pack 3 stampi termoformati (3 misure)

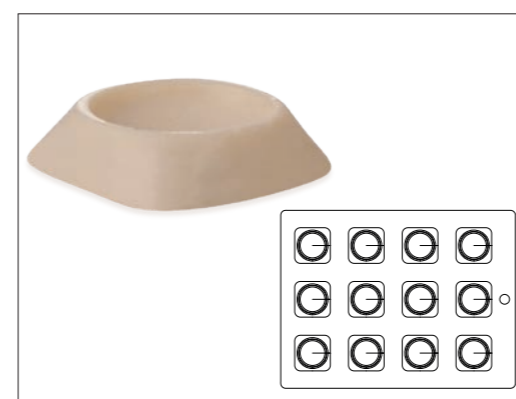

Eggs holders

Chocolate holders/supporti di cioccolato

- support size: 36,5 x 36,5 h 9 mm ~ 10 gr - Prod. 12 pcs (ideal for SM 1000/SM 2000/SM 2300)
- support size: 40,5 x 40,5 h 12 mm ~ 18 gr - Prod. 9 pcs (ideal for SM 2500)
- support size: 52,7 x 52,7 h 12 mm ~ 28 gr - Prod. 6 pcs (ideal for SM 3000/SM 3500/SM 4000)

20-CU001

EASTER FIGURES/SOGGETTI DI PASQUA



Professional moulds/stampi
275 x 205 mm

Ms Hen **New**

126 x 81 h 150 mm - Weight ~ 54 gr
Prod. 2+2 pcs - Layout 2 x 1 - BPA Free
Each pack contains 2 moulds.
Ogni confezione contiene 2 stampi.



21SR005G - 2 moulds for artisanal production with hooks
2 stampi per produzione artigianale con ganci

21SR005AG - 2 moulds for rotating machines with hooks
2 stampi per rotativa con ganci



Professional moulds/stampi
275 x 205 mm

Lil Chick **New**

94 x 62 h 108,5 mm - Weight ~ 37 gr
Prod. 4+4 pcs - Layout 2 x 2 - BPA Free
Each pack contains 2 moulds.
Ogni confezione contiene 2 stampi.



21SR006G - 2 moulds for artisanal production with hooks
2 stampi per produzione artigianale con ganci

21SR006AG - 2 moulds for rotating machines with hooks
2 stampi per rotativa con ganci





Professional moulds/stampi
275 x 205 mm

Peter New

89 x 89 h 110 mm - Weight ~ 38 gr
Prod. 4 + 4 pcs - Layout 2 x 2 - BPA free
Each pack contains 2 moulds.
Ogni confezione contiene 2 stampi.



21SR007G - 2 moulds for artisanal production with hooks
2 stampi per produzione artigianale con ganci

21SR007AG - 2 moulds for rotating machines with hooks
2 stampi per rotativa con ganci



Professional moulds/stampi
275 x 205 mm

Fluffy New

75 x 81 h 62,5 - Weight ~ 30 gr
Prod. 6 + 6 pcs - Layout 3 x 2 - BPA free
Each pack contains 2 moulds.
Ogni confezione contiene 2 stampi.



21SR008G - 2 moulds for artisanal production with hooks
2 stampi per produzione artigianale con ganci

21SR008AG - 2 moulds for rotating machines with hooks
2 stampi per rotativa con ganci



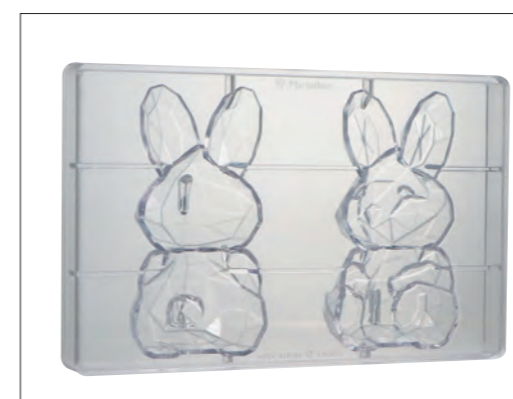

Roger

78 x 73 h 150 mm
 Weight ~ 130 gr - Prod. 1 pc
 Professional mould 275 x 175 mm

MA3016



Rabbit

Chick



120 x 120 h 220 mm
Weight ~ 480 gr - Prod. 1 pc
Thermoformed 3D moulds

160 x 120 h 210 mm
Weight ~ 460 gr - Prod. 1 pc
Thermoformed 3D moulds

MAC604S

MAC602S



Rooster

Chick

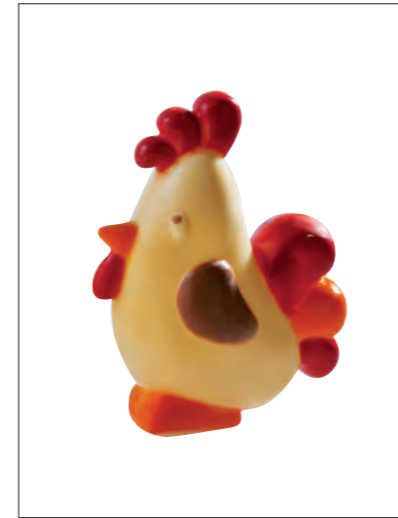

100 x 160 h 126 mm
Weight ~ 80 gr - Prod. 2 pcs
Professional mould
275 x 175 mm

65 x 84 h 80 mm
Weight ~ 45 gr - Prod. 6 pcs
Professional mould
275 x 175 mm

20-C1955

20-C1957



Thermoformed 3D plastic moulds
Stampi 3D in plastica termoformata

Mr. Bunny



90 x 60 h 152 mm
Weight ~100 gr - Prod. 1 pc

MAC616S

Ms Cocodé



108 x 75 h 120 mm
Weight ~90 gr - Prod. 1 pc

MAC615S



Hug in Egg



h 170 mm (2 fig.) - Prod. 2 pcs

MAC720S

Baby Bunny



h 180 mm - Prod. 1 pc

MAC620S

Bunny



h 140 mm - Prod. 1 pc

MAC661S



SPECIALS/SPECIALI

Eau de chocolat



60 x 31 h 92 mm
Weight ~ 90gr - Prod. 4 pcs
4 Thermoformed moulds

20PA01

My sweet bag



119 x 52 h 126
Weight ~ 190gr - Prod. 2 pcs
2 Thermoformed moulds

20BA01



Big lady shoe



220 x 85 h165 mm
Weight ~ 375 gr - Prod. 1 pc
Thermoformed mould

MAC326S

Lady shoe



160 x 70 h 120 mm
Weight ~ 120gr - Prod. 1 pc
Professional mould

MAC330





Smooth Heart

75 x 70 h 22 mm
Weight ~ 27 gr
Prod. 6 pcs
Layout 3 x 2
Professional mould
275 x 175 mm

MA1996

45 x 42 h 16 mm
Weight ~ 14 gr
Prod. 12 pcs
Layout 4 x 3
Professional mould
275 x 175 mm

MA1995



Diamond Heart

70 x 66 h 20 mm
Weight ~ 17 gr
Prod. 6 pcs
Layout 3 x 2
Professional mould
275 x 175 mm

MA3015



Mr Cigar

ø 20 x 125 mm
Weight ~ 40 gr - Prod. 8 pcs
Thermoformed plastic mould

20SI01

Mr Chocolate

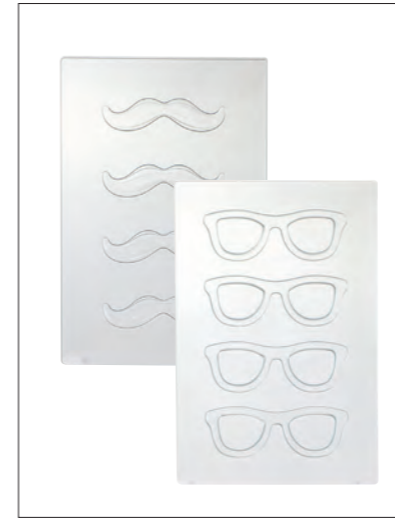

mustache: 117 x 30 h 15 mm
glasses: 140 x 50 h 10 mm
Weight ~ 22 gr - Prod. 4+4 pcs
Thermoformed plastic mould

20OB01

Mr Papillon



120 x 52 h 13 mm
Weight ~ 55 gr
Prod. 12 pcs
Thermoformed plastic mould

20PP01

Chess game



ø 25/35 h 40/80 mm
Weight ~11/36 gr
Prod. 20 mix pcs
Thermoformed plastic mould

20CG01

Working tools



190 x 50 / 115 x 20 mm
Weight ~20/50 gr
Prod. 20 mix pcs
Thermoformed plastic mould

20WT01

Football boot



195 x 60 h 80 mm
Prod. 1 pc
Thermoformed plastic mould with clamps

MAC322S

Soccer ball



ø 120 mm
Prod. 1 pc
Thermoformed plastic mould with clamps

MAC323S

SPECIALS & NAPOLITAINS





CIRCLE DISK/DISCHETTI

Professional chocolate mould
Stampi professionali per cioccolato
275 x 175 mm

Circle 30



ø 30 h 3 mm
Weight ~ 2,5 gr - Prod. 24 pcs
Layout 6 x 4

MA1026

Circle 33

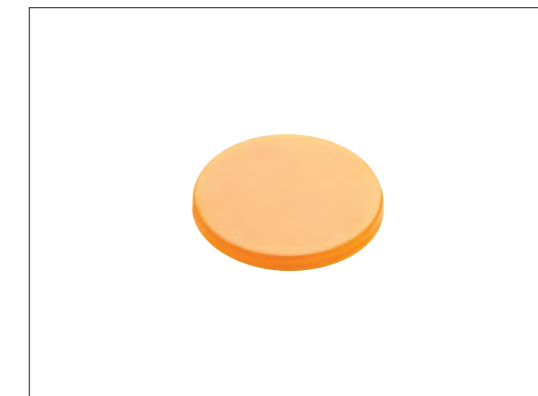

ø 33 h 4 mm
Weight ~ 4 gr - Prod. 24 pcs
Layout 6 x 4

MA1027

Circle 40



ø 40 h 4 mm
Weight ~ 5,5 gr - Prod. 15 pcs
Layout 5 x 3

MA1028

Circle 75



ø 75 h 5 mm
Weight ~ 25 gr - Prod. 6 pcs
Layout 3 x 2

MA1030

CUPS & SPOON/TAZZE & CUCCHIAINO

Professional chocolate mould
 Stampi professionali per cioccolato
 275 x 175 mm

Spoon



92 x 26 h 7 mm
 Weight ~ 6 gr
 Prod. 13 pcs

MA3006

Big Cup



55 x 69 h 34 mm
 Weight ~ 20 gr
 Prod. 7 pcs

MA1951

Small Cup



47 x 59 h 30 mm
 Weight ~ 17 gr
 Prod. 7 pcs

MA1953





CHOCOLATE MIGNON

Professional chocolate mould
 Stampi professionali per cioccolato
 275 x 175 mm

A chocolate mignons moulds collection for making pralines or exquisite small mignon holders. Some of the collection models were inspired by the ice-cream waffle cones and mini-cups. Besides making shiny and uniform chocolates, the professional moulds of Martellato helps remove the pralines with greater ease and minimises any risk of breaking them.

Una collezione di stampi per mignon di cioccolato ideale per preparare praline o piccoli contenitori per mignon dal grande sapore: Martellato ha realizzato una serie di modelli ispirati ai coni cialda e alle coppette per gelato. Oltre a conferire al cioccolato brillantezza e uniformità, lo stampo professionale made in Martellato agevola la sformatura e minimizza ogni rischio di rottura.

Cornetto



ø 32 h 37 mm
 Weight ~ 10 gr - Prod. 20 pcs
 Layout 5 x 4

20GU001

Stella



ø 40 h 17 mm
 Weight ~ 10 gr - Prod. 15 pcs
 Layout 5 x 3

20GU002

Flora



33 x 31 h 20 mm
 Weight ~ 10 gr - Prod. 24 pcs
 Layout 6 x 4

20GU003



Cercle



ø 37 h 14 mm
Weight ~ 10 gr - Prod. 15 pcs
Layout 5 x 3

20GU007

Cube



27 x 27 h 31 mm
Weight ~ 10 gr - Prod. 28 pcs
Layout 7 x 4

20GU008

Carrè



33 x 33 h 14 mm
Weight ~ 10 gr - Prod. 24 pcs
Layout 6 x 4

20GU009

Beso



33 x 33 h 23 mm
Weight ~ 10 gr - Prod. 24 pcs
Layout 6 x 4

20GU004

Mug



32 x 42 h 29 mm
Weight ~ 10 gr - Prod. 24 pcs
Layout 6 x 4

20GU005

Rondes



ø 27 h 31 mm
Weight ~ 10 gr - Prod. 28 pcs
Layout 7 x 4

20GU006

Cup



44 x 56 h 39 mm
Weight ~ 10 gr - Prod. 12 pcs
Layout 4 x 3

20GU500

Coupe



ø 40 h 18,5 mm
Weight ~ 10 gr - Prod. 15 pcs
Layout 5 x 3

20GU501

Cafe



44 x 55 h 23 mm
Weight ~ 10 gr - Prod. 12 pcs
Layout 4 x 3

20GU502

NAPOLITAINS

Professional chocolate mould
 Stampi professionali per cioccolato
 275 x 175 mm

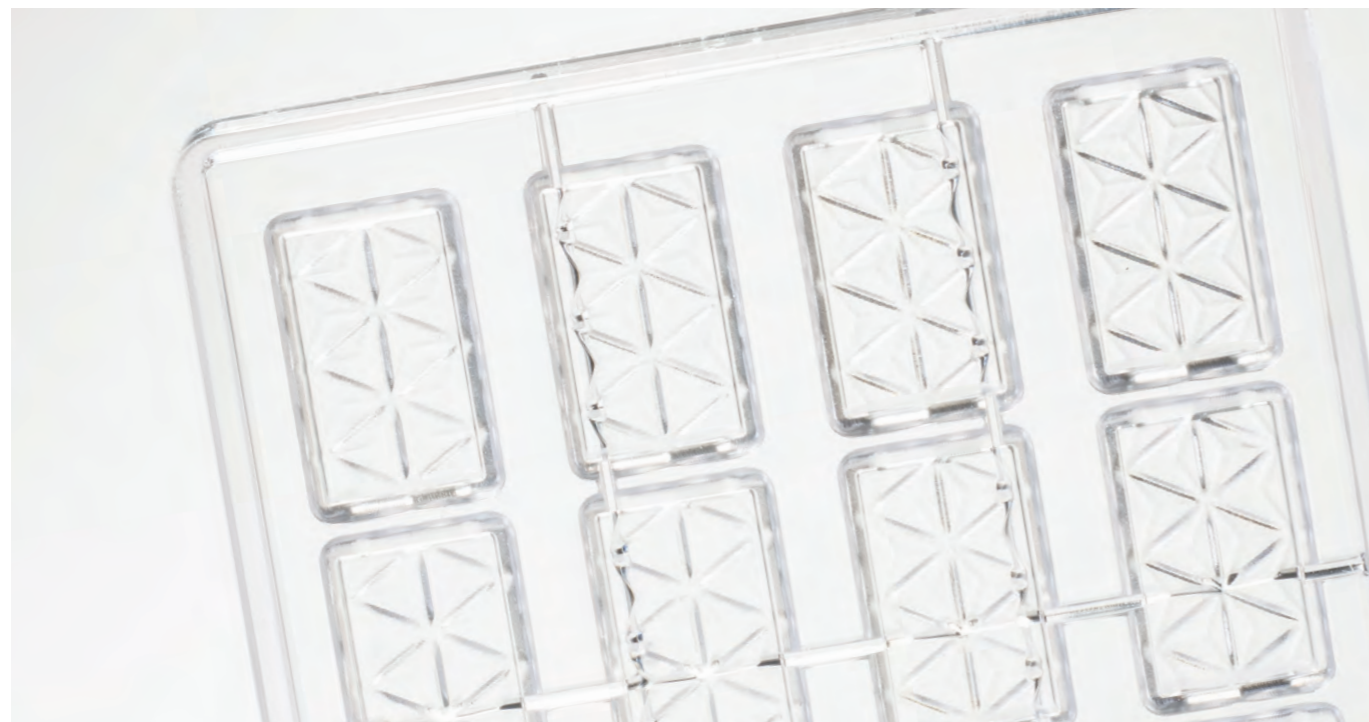

Timeless



74 x 33 h 5 mm
 Weight ~ 13 gr - Prod. 12 pcs
 Layout 3 x 4

MA2007

Lulu



32 x 32 h 4 mm
 Weight ~ 5 gr - Prod. 24 pcs
 Layout 6 x 4

MA2002

Liquid

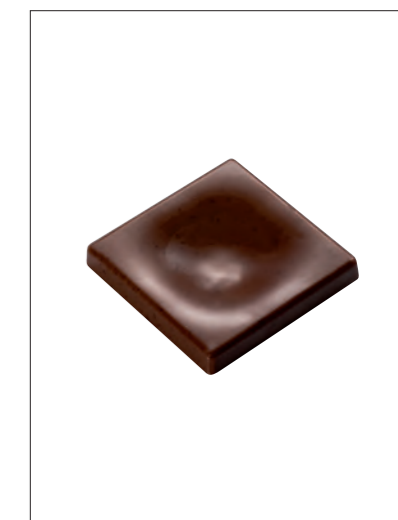

31 x 31 h 4,5 mm
 Weight ~ 4 gr - 24 pcs
 Layout 6 x 4

MA6001

City



34 x 34 h 4 mm
 Weight ~ 4 gr -Prod. 24 pcs
 Layout 6 x 4

MA6006

Brick

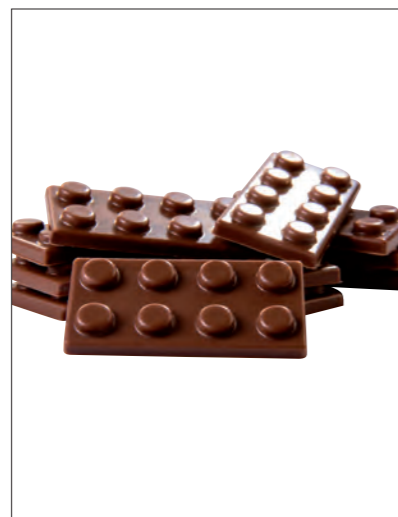

45 x 23 h 6 mm
 Weight ~ 4 gr - Prod. 20 pcs
 Layout 5 x 4

MA6005

Classic



50 x 26 h 3 mm
 Weight ~ 5 gr - Prod. 16 pcs
 Layout 4 x 4

MA2006

Spiral



ø 39 h 4,5 mm
 Weight ~ 4 gr - Prod. 15 pcs
 Layout 5 x 3

MA6003

Jem



42 x 25 h 6 mm
 Weight ~ 4 gr - Prod. 20 pcs
 Layout 5 x 4

MA6002

LOLLIPOPS

Egg



52 x 77 h 9 mm
Weight ~ 30 gr
Prod. 8 pcs
2 Thermoformed mould
20L001

Round bar



ø 60 h 9 mm
Weight ~ 30 gr
Prod. 8 pcs
2 Thermoformed mould
20L002

Rectangular



50 x 75 h 9 mm
Weight ~ 30 gr
Prod. 8 pcs
2 Thermoformed mould
20L003

Thermoformed plastic mould
Stampo in plastica termoformata

Xmas



Tree / Albero:
70 x 76 h 9 mm ~ 34 gr
Star/Stella:
77 x 74 h 9 mm ~ 31 gr
Prod. 4 + 4 pcs
20L005

Pumpkin & Skull



Pumpkin / Zucca:
69 x 70 h 9 mm ~ 33 gr
Skull/Teschio:
53 x 70 h 9 mm ~ 32 gr
Prod. 4 + 4 pcs
20L006



Rounded



ø 50 h 9 mm - Weight ~ 25 gr
2 moulds - Prod. 5+5 pcs
20L007

Oval



43 x 57 h 9 mm - Weight ~ 22 gr
2 moulds - Prod. 5+5 pcs
20L008

Heart



68 x 65 h 9 mm - Weight ~ 34 g
2 moulds - Prod. 8 pcs
20L004

Display



Plexiglass - Cap. 56 pcs
345 x 280 h 40 mm
EL101

Lollipop bags



90 x 130 mm - 200 pcs
For lollipops and candies
20S005



HALF-SPHERES & DECORATIONS



HALF-SPHERES/SEMISFERE



Light Spheres 6

Kit 6 Thermoformed Moulds/*Stampi Termoformati*
225 x 225 mm - 175 x 175 mm

ø 100 mm - Prod. 1 pc
ø 130 mm - Prod. 1 pc
ø 140 mm - Prod. 1 pc
ø 150 mm - Prod. 1 pc
ø 175 mm - Prod. 1 pc
ø 200 mm - Prod. 1 pc

20SF001



Light Spheres 4

Kit 4 Thermoformed Moulds/*Stampi Termoformati*
225 x 225 mm

ø 50 mm - Prod. 6 pcs
ø 65 mm - Prod. 4 pcs
ø 75 mm - Prod. 4 pcs
ø 90 mm - Prod. 2 pcs

20SF002

Excellent spheres

Professional chocolate mould
Stampi professionali per cioccolato
275 x 175 mm



Cod.	Size (mm)	Weight	Layout	Prod.
MA5003	ø 20	~ 2,5 gr (full) / ~ 1,5 gr (shell)	9 x 5	45 pcs
MA5007	ø 25	~ 5 gr (full) / ~ 2,6 gr (shell)	7 x 4	28 pcs
MA5000	ø 30	~ 9 gr (full) / ~ 4 gr (shell)	6 x 4	24 pcs
MA5008	ø 35	~ 13 gr (full) / ~ 8 gr (shell)	5 x 3	15 pcs
MA5004	ø 40	~ 11 gr (shell)	5 x 3	15 pcs
MA5009	ø 45	~ 13 gr (shell)	4 x 3	12 pcs
MA5001	ø 50	~ 17 gr (shell)	4 x 2	8 pcs
MA5010	ø 55	~ 20 gr (shell)	3 x 2	6 pcs
MA5005	ø 60	~ 25 gr (shell)	3 x 2	6 pcs
MA5006	ø 80	~ 50 gr (shell)	2 x 2	4 pcs
MA5002	ø 100	~ 80 gr (shell)	2 x 2	2 pcs





TYPEFACE & SNOWFLAKES

LETTERE E FIOCCHI DI NEVE

Professional chocolate mould
 Stampi professionali per cioccolato
 275 x 175 mm

Whether semifreddi, cakes or chocolate pieces, with these decoration moulds you can make letters and numbers for special occasions such as birthdays or anniversaries, or you can create tasty compositions with the chocolate snowflake mould in different sizes. All you have to do is simply use your imagination.

Che siano semifreddi, torte o piece in cioccolato, con questi stampi per decoro potrai realizzare lettere e numeri da utilizzare nelle occasioni speciali come compleanni o anniversari, oppure potrai creare gustose composizioni con lo stampo per fiocchi di neve in cioccolato dalle diverse misure. Quello che devi fare è semplicemente usare la fantasia.



Letters & Numbers

h 30 mm

MA3005

**LETTERS AND
NUMBERS
123456789**

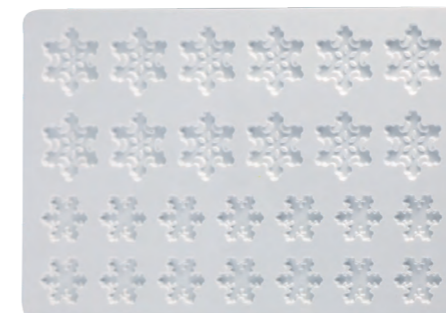

Snowflakes

14 pcs ø 30 h 4 mm - Weight ~1 gr
 12 pcs ø 40 h 4 mm - Weight ~2 gr

20-D029



STAMPS/TIMBRI



Stamps is the prestigious line of brass stamps created by Frank Haasnoot to realize elegant chocolate decorations for many occasions, whether festivities or special events. Different decorations in various sizes to easily garnish single-portion desserts or cakes.

Stamps è la prestigiosa linea di timbri in ottone realizzata da Frank Haasnoot per creare eleganti decorazioni di cioccolato da utilizzare per le diverse occasioni, siano esse festività o eventi speciali. Tanti decori in differenti misure permettono di guarnire con semplicità dessert, monoporzioni o torte.

Santa Claus



ø 6 cm - Prod. 1 pc

20FH38L

Merry Xmas



ø 6 cm - Prod. 1 pc

20FH35L



Happy Birthday



ø 3 cm - 1 pc - **20FH30S**

ø 6 cm - 1 pc - **20FH30L**

Happy Easter



ø 3 cm - 1 pc - **20FH36S**

ø 6 cm - 1 pc - **20FH36L**

Cocoa



ø 6 cm - Prod. 1 pc

20FH32L

Coffee



ø 6 cm - Prod. 1 pc

20FH34L

Vanilla



ø 6 cm - Prod. 1 pc

20FH33L

Happy Valentine



ø 3 cm - 1 pc - **20FH37S**

ø 6 cm - 1 pc - **20FH37L**

Love



ø 3 cm - 1 pc - **20FH31S**

ø 6 cm - 1 pc - **20FH31L**

COMBS/PETTINI



The Combs collection made by Frank Haasnoot is ideal for preparing elegant and refined decorations. Thanks to this tool, you will be able to create leaves and toppings of different shapes to easily decorate cakes and single portions.

La collezione di di pettini Combs, realizzata da Frank Haasnoot, è ideale per preparare decorazioni dall'aspetto elegante e raffinato. Grazie a questo strumento sarà possibile creare foglie e guarnizioni di diverse forme per decorare con facilità dolci e monoporzioni.



Leaf Eclair

h 25 mm - Prod. 6 pcs

20FH04



Leaf Comb

h 60 mm - Prod. 8 pcs

20FH01S



Leaf Comb

h 80 mm - Prod. 8 pcs

20FH01L



Butterfly

h 60 mm - Prod. 3+3 pcs

20FH07S

h 80 mm - Prod. 3+3 pcs

20FH07L



Find out how to create decorations with the combs

Scopri come creare le decorazioni con i comb



Feather Eclair

h 25 mm - Prod. 6 pcs

20FH05



Petal Eclair

h 25 mm - Prod. 6 pcs

20FH06



Feather Comb

h 60 mm - Prod. 8 pcs

20FH02S



Petal Comb

h 60 mm - Prod. 8 pcs

20FH03S

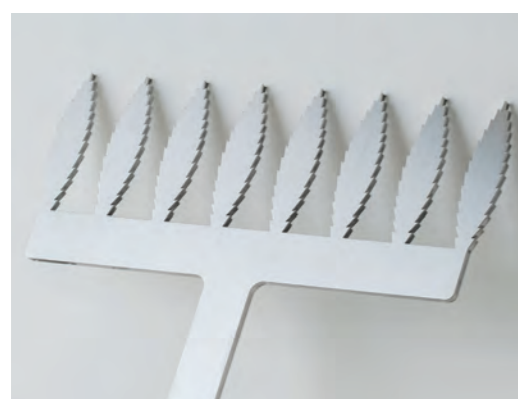

Feather Comb

h 80 mm - Prod. 8 pcs

20FH02L



Petal Comb

h 80 mm - Prod. 8 pcs

20FH03L





TEMPLATE



Three templates with a modern design to quickly create perfect chocolate edging for decorating cakes and single portions. The different stainless steel shapes and templates, designed and realized by the internationally renowned pastry chef Frank Haasnoot, will give an original and innovative touch to your creations.

Tre template dal design moderno per realizzare velocemente bordature in cioccolato perfette nella decorazione di torte e monoporzioni. Le diverse forme e sagome in acciaio inox, disegnate e realizzate dal pasticciere di fama internazionale Frank Haasnoot, daranno un tocco originale e innovativo alle tue creazioni.



Find out how to create decorations with the template

Scopri come creare le decorazioni con i template



Drop

300 h 70 mm

20FH51



Flame

300 h 80 mm

20FH52



Heart Beat

300 h 85 mm

20FH53

CHABLON PROJECT

Professional silicone mats
 Tappeti professionali in silicone 390 x 290 mm
 Thickness/spessore 1,5 mm

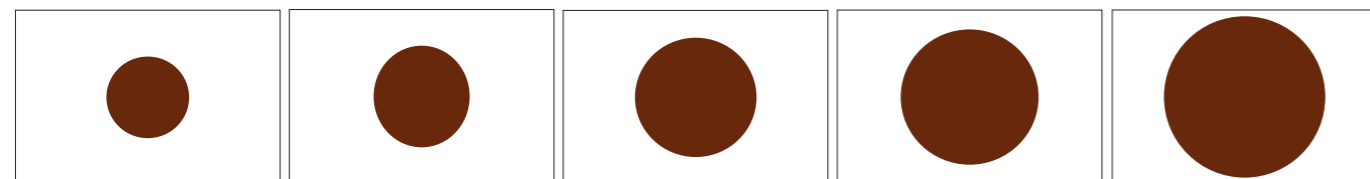

ø 20 mm Prod. 99 pcs ø 26 mm Prod. 48 pcs ø 36 mm Prod. 36 pcs ø 42 mm Prod. 30 pcs ø 62,5 mm Prod. 12 pcs

CHASIL 21 **CHASIL 16** **CHASIL 17** **CHASIL 18** **CHASIL 26**

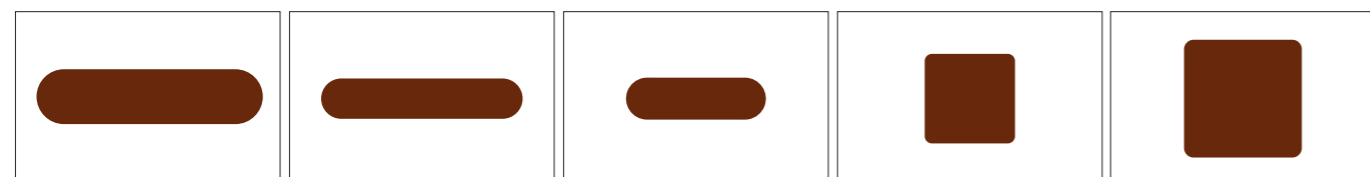

132 x 32 mm Prod. 10 pcs 125 x 25 mm Prod. 18 pcs 60 x 18 mm Prod. 36 pcs 25 x 25 mm Prod. 63 pcs 37,5 x 37,5 mm Prod. 30 pcs

CHASIL 20 **CHASIL 27** **CHASIL 28** **CHASIL 23** **CHASIL 24**

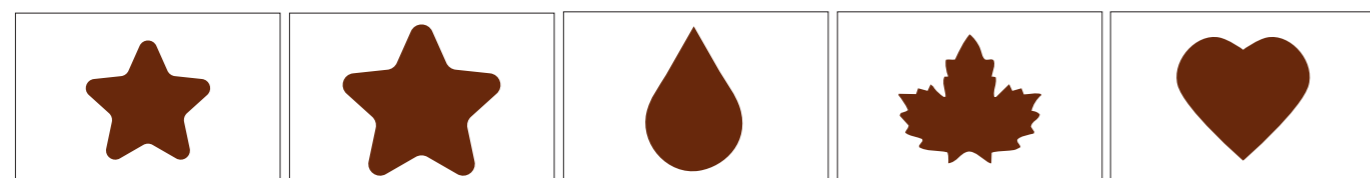

ø 26 mm Prod. 60 pcs ø 34 mm Prod. 42 pcs 35 x 25 mm Prod. 60 pcs 35 x 33 mm Prod. 48 pcs 35 x 25 mm Prod. 48 pcs

CHASIL 29 **CHASIL 30** **CHASIL 1** **CHASIL 2** **CHASIL 3**

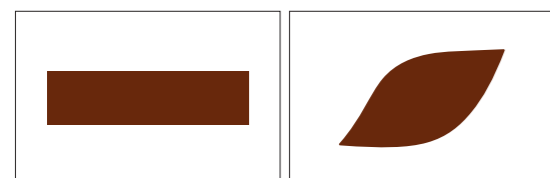

32 x 120 mm Prod. 12 pcs 75 x 33 mm Prod. 25 pcs

CHASIL 19 **CHASIL 22**

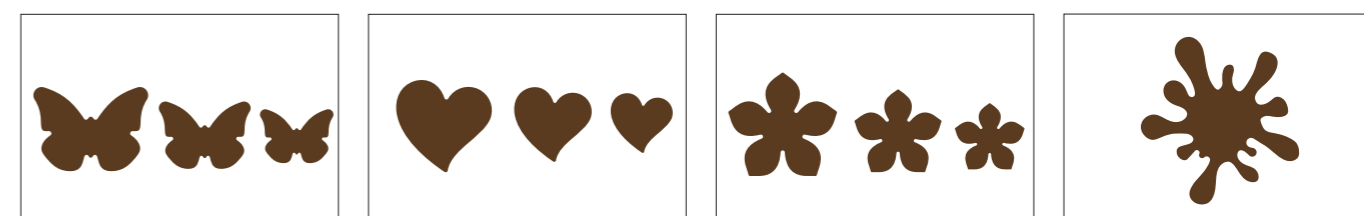

60 x 44 mm - 8 pcs 45 x 43 mm - 8 pcs 52 x 49 mm - 8 pcs 60 x 63 mm Prod. 16 pcs
 54 x 40 mm - 8 pcs 40 x 39 mm - 8 pcs 42 x 40 mm - 8 pcs
 46 x 34 mm - 12 pcs 35 x 34 mm - 12 pcs 33 x 31 mm - 12 pcs

CHASIL 31 **CHASIL 33** **CHASIL 34** **CHASIL 32**

CHOCO TOOLS/ACCESSORI CIOCCOLATO

St. steel wire forks with plastic handle.
 Forchette in filo di acciaio inox con manico in plastica.

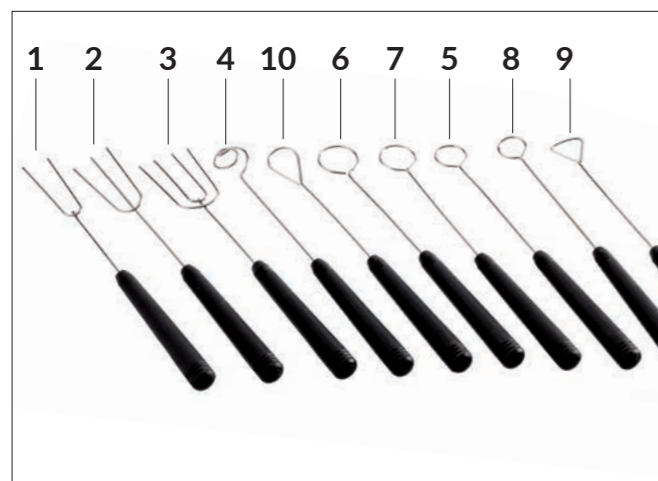

Cod.	Type
CHOCOFORK	Kit of 10 mixed forks (1 for each type) Kit di 10 forchette assortite (1 per tipo)

Cod.	Type	Pack
50CHOC01	1	25 pcs
50CHOC02	2	25 pcs
50CHOC03	3	25 pcs
50CHOC04	4	25 pcs
50CHOC05	5	25 pcs
50CHOC06	6	25 pcs
50CHOC07	7	25 pcs
50CHOC08	8	25 pcs
50CHOC09	9	25 pcs
50CHOC10	10	25 pcs

CHOCO BOX/SCATOLE PER CIOCCOLATO

Boxes for displaying and transporting pralines and chocolate subjects with transparent cavities.
 Each cavity is 10 x 31 x 26 mm.
 Scatole per l'esposizione e il trasporto di praline e soggetti in cioccolato con alveoli trasparenti.
 Ogni alveolo misura 10 x 31 x 26 mm.



Box with satin-finish border.
 Scatola con bordo satinato.

Cod.	Size	Cavities Alveoli	Pack
MSC201	31 x 26 h 10 mm	6	25 pcs
MSC202	31 x 26 h 10 mm	12	25 pcs



Box with transparent border.
 Scatola con bordo trasparente.

Cod.	Size	Cavities Alveoli	Pack
MSC001	31 x 26 h 10 mm	5	25 pcs
MSC002	31 x 26 h 10 mm	9	25 pcs
MSC003	31 x 26 h 10 mm	12	25 pcs
MSC004	31 x 26 h 10 mm	20	25 pcs

SEMIFREDDO & BAKING

SILICONE MOULDS



BLOCK

Silicone Moulds

A NEW WAY OF MAKING CAKES

Three new forms to express a different idea of dessert. Block is the new line of silicone moulds designed by Frank Haasnoot, created in collaboration with Martellato, to easily and quickly create layered single portions, without compromising on a modern and impactful design. Silicone moulds 297 x 176 mm. A 60 x 40 baking tray can accommodate 4 Block moulds.

Tre nuove forme per esprimere un'idea diversa di dessert. Block è la nuova linea di stampi in silicone disegnata da Frank Haasnoot, realizzata in collaborazione con Martellato, per realizzare monoporzioni a strati in modo semplice e veloce, senza rinunciare a un design moderno e d'effetto. Stampi in silicone 297 x 176 mm. Una teglia 60 x 40 può contenere 4 stampi Block.



Designed in
collaboration with

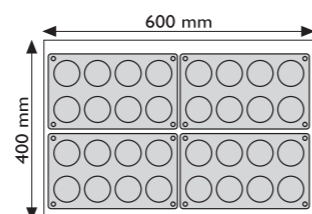



FRANK HAASNOOT World Champion Pastry Chef



FRANK HAASNOOT for Block & BlackSil

The more you know and explore, the more you can create. There's no end to imagination with BlackSil. The Frank Haasnoot's secret to make the perfect dessert in a perfect shape is to use the right silicone mould, the one that is studied and tested for a long time, in order to find the right compromise. When you find it, you can exploit your creativity and make your piece of art. This is how BlackSil is born.

Più si conosce e si esplora, più si può creare. Con BlackSil l'immaginazione non ha mai fine. Qual è il segreto del campione del mondo Frank Haasnoot per ottenere sempre risultati perfetti? Utilizzare lo stampo appropriato in ogni creazione, studiato e testato a lungo fino a trovare il giusto compromesso tra qualità e design. Quando lo trovi, puoi dare sfogo alla creatività e realizzare delle vere e proprie opere d'arte. Così è nato BlackSil.

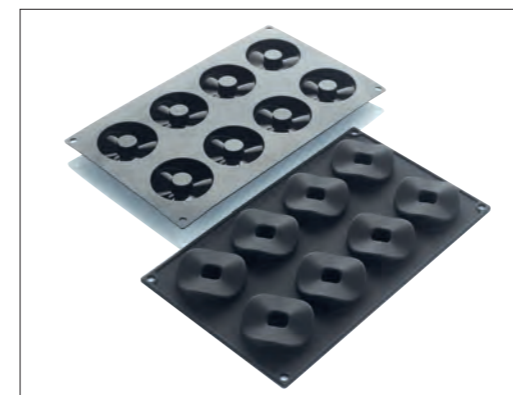

New
Cylinder

Single layer/strato: \varnothing 60 h 17 mm
 Vol. ~ 30 ml - Prod. 8 + 8 layers/strati
 Layout 4 x 2
 Each pack contains 2 moulds.
 Ogni confezione contiene 2 stampi.

30SIL600

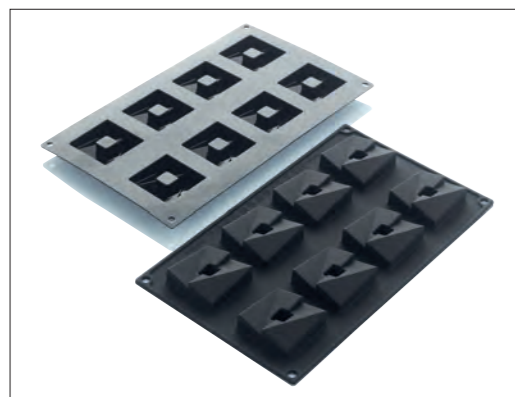

New
Cube

Single layer/strato: 50 x 50 h 16 mm
Vol. ~ 28 ml - Prod. 8 + 8 layers/strati
Layout 4 x 2
Each pack contains 2 moulds.
Ogni confezione contiene 2 stampi.

30SIL601

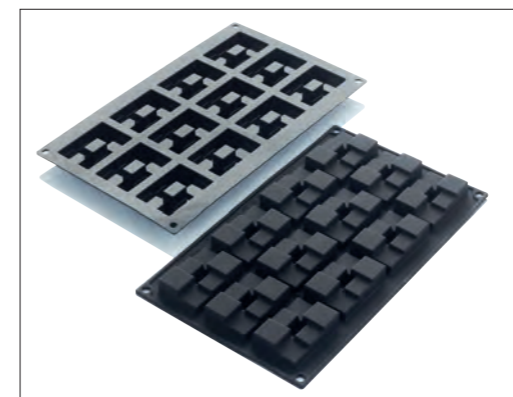

New
Brick

Single layer/strato: 60 x 40 h 16 mm
Vol. ~ 27 ml - Prod. 12 + 12 layers/strati
Layout 4 x 3
Each pack contains 2 moulds.
Ogni confezione contiene 2 stampi.

30SIL602

RECOMMENDED BY

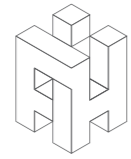
**FRANK
HAASNOOT**
PASTRY CHEF

TRUST THE BLACK

The BlackSil line stems from the imagination of Martellato designers, drawing inspiration from nature and its elements until they find the spark for a new silicone mould. From here, an essential and modern design comes to life, crafted to leave ample room for the pastry chef's creativity. Trust in Martellato's black silicone, developed to ensure unprecedented levels of excellence and proudly made in Italy. Silicone moulds 297 x 176 mm. A 60 x 40 baking tray can accommodate 4 moulds.

La linea BlackSil nasce dall'immaginazione dei designer Martellato, che si ispirano alla natura e ai suoi elementi, fino a trovare la scintilla per un nuovo stampo in silicone.

Da qui prende vita un design essenziale e moderno, studiato in modo da lasciare ampio spazio alla creatività del pasticcere. Fidati del silicone nero Martellato, sviluppato per assicurare livelli di eccellenza mai visti prima e made in Italy.

Stampi in silicone 297 x 176 mm. Una teglia 60 x 40 può contenere 4 stampi BlackSil.



Watch the
video recipe
by F. Haasnoot



SINGLE PORTIONS/MONOPORZIONI



New

Medusa

Single portion: 72 x 72 h 40 mm
Vol. ~ 113 ml - Prod. 6 pcs
Layout 3 x 2

30SIL512



New

Coco

Single portion: 71 x 70 h 53 mm
Vol. ~ 109 ml - Prod. 6 pcs
Layout 3 x 2

30SIL513



New

Vibes

Single portion: 58 x 62,5 h 45 mm
Vol. ~ 111 ml - Prod. 6 pcs
Layout 3 x 2

30SIL515



New

Marina

Single portion: 77 x 74 h 40 mm
Vol. ~ 105 ml - Prod. 6 pcs
Layout 3 x 2

30SIL510



**New**

Calipso

Single portion: 79 x 59 h 54,5 mm
 Vol. ~ 100 ml - Prod. 6 pcs
 Layout 3 x 2

30SIL511

Donuts

Single portion: ø 75 h 25 mm
 Vol. ~ 89 ml - Prod. 6 pcs
 Layout 3 x 2

30SIL503

Harmony

Single portion: 63 x 63 h 53 mm
 Vol. ~ 110 ml - Prod. 6 pcs
 Layout 3 x 2

30SIL508**New**

Satin

Single portion: 76 x 74 h 36 mm
 Vol. ~ 110 ml - Prod. 6 pcs
 Layout 3 x 2

30SIL514



Box

Single portion: 64 x 64 h 34 mm
Vol. ~ 115 ml - Prod. 6 pcs
Layout 3 x 2

30SIL501

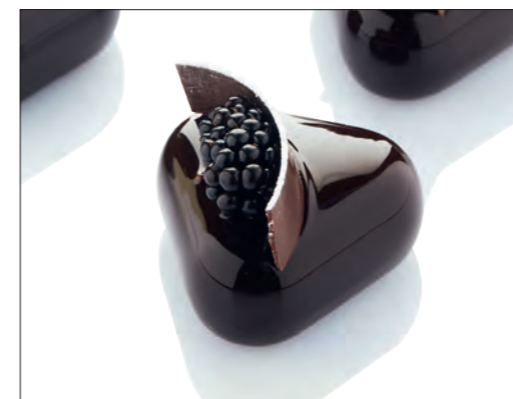

Triangle

Single portion: 71,5 x 67 h 35,5 mm
Vol. ~ 104 ml - Prod. 6 pcs
Layout 3 x 2

30SIL507



Love

Single portion: 74,5 x 68 h 30 mm
Vol. ~ 89 ml - Prod. 6 pcs
Layout 3 x 2

30SIL502



Eclair

Single portion: 130 x 30 h 28 mm
Vol. ~ 84 ml - Prod. 6 pcs
Layout 6 x 1

30SIL504



Circle

Single portion: ø 69 h 35 mm
Vol. ~ 110 ml - Prod. 6 pcs
Layout 3 x 2

30SIL500

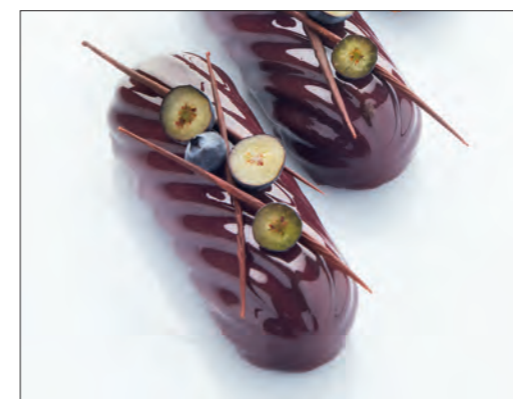

Twist Eclair

Single portion: 120 x 40 h 33 mm
Vol. ~ 110 ml - Prod. 5 pcs
Layout 5 x 1

30SIL505



Ritmo

Single portion: 128 x 36 h 32,5 mm
Vol. ~ 108 ml - Prod. 5 pcs
Layout 5 x 1

30SIL509



Twist

Single portion: ø 62 h 55 mm
Vol. ~ 110 ml - Prod. 6 pcs
Layout 3 x 2

30SIL506





Muffin ø 81

ø 81 h 32
Vol. ~ 129 ml - Prod. 5 pcs

30SF024

Muffin ø 68

ø 68 h 38
Vol. ~ 120 ml - Prod. 6 pcs
Layout 3 x 2

30SF102

Muffin ø 75

ø 75 h 59
Vol. ~ 170 ml - Prod. 6 pcs
Layout 3 x 2

30SF052

Muffin ø 51

ø 51 h 28
Vol. ~ 50 ml - Prod. 11 pcs

30SF022

Muffin ø 69

ø 69 h 35
Vol. ~ 100 ml - Prod. 6 pcs
Layout 3 x 2

30SF023

Gugelhopf ø 70



ø 70 h 36
Vol. ~ 80 ml - Prod. 6 pcs
Layout 3 x 2

30SF058

Gugelhopf ø 55



ø 55 h 36
Vol. ~ 50 ml - Prod. 8 pcs
Layout 4 x 2

30SF057

Mini Cake



69 x 69 h 60
Vol. ~ 174 ml - Prod. 6 pcs
Layout 3 x 2

30SF168

Tartlet ø 60



ø 60 / ø 42 h 17
Vol. ~ 40 ml - Prod. 8 pcs
Layout 4 x 2

30SF015

Tartlet ø 70



ø 70 / ø 51 h 20
Vol. ~ 70 ml - Prod. 6 pcs
Layout 3 x 2

30SF016

Cylinder ø 60



ø 60 / ø 52 h 35
Vol. ~ 90 ml - Prod. 8 pcs
Layout 4 x 2

30SF028

Marsigliese



95 x 35 h 25
Vol. ~ 68 ml - Prod. 7 pcs

30SF114

Sponge



ø 100 h 20
Vol. ~ 140 ml - Prod. 3 pcs

30SF042

Waffle



130 x 81 h 17
Vol. ~ 60 ml - Prod. 4 pcs
Layout 2 x 2

30SF155

Heart ø 65

ø 65 h 60
Vol. ~ 131 ml - Prod. 6 pcs
Layout 3 x 2

30SF036**Heart ø 60**

ø 60 h 35
Vol. ~ 90 ml - Prod. 8 pcs
Layout 4 x 2

30SF040**Donut**

ø 75 / ø 25 h 28
Vol. ~ 98 ml - Prod. 6 pcs
Layout 3 x 2

30SF170**Bavarian**

ø 57 h 57
Vol. ~ 130 ml - Prod. 8 pcs
Layout 4 x 2

30SF051**Marguerite**

ø 70 h 28
Vol. ~ 80 ml - Prod. 6 pcs
Layout 3 x 2

30SF056**Mix**

ø 75 h 40
Vol. ~ 100 ml - Prod. 6 pcs
Layout 3 x 2

30SF061**Briochette ø 79**

ø 79 h 30
Vol. ~ 110 ml - Prod. 6 pcs
Layout 3 x 2

30SF035**Briochette ø 76**

ø 76 h 37
Vol. ~ 110 ml - Prod. 6 pcs
Layout 3 x 2

30SF034**Pyramid 71**

71 x 71 h 40
Vol. ~ 90 ml - Prod. 6 pcs
Layout 3 x 2

30SF007**Babà ø 55**

ø 55 h 60
Vol. ~ 92 ml - Prod. 8 pcs
Layout 4 x 2

30SF021**Babà ø 45**

ø 45 h 48
Vol. ~ 50 ml - Prod. 11 pcs

30SF020



Savarin ø 72

ø 72 h 23
Vol. ~ 62 ml - Prod. 6 pcs
Layout 3 x 2

30SF012

Savarin ø 65

ø 65 h 21
Vol. ~ 50 ml - Prod. 8 pcs
Layout 4 x 2

30SF011

Diamond ø 68



ø 68 h 45
Vol. ~ 98 ml - Prod. 6 pcs
Layout 3 x 2

30SF049

Plum cake



79 x 29 h 30
Vol. ~ 70 ml - Prod. 12 pcs
Layout 3 x 4

30SF026

Financier 95



95 x 45 h 12
Vol. ~ 50 ml - Prod. 7 pcs

30SF054

Savoiaro



127.5 x 47 h 17
Vol. ~ 83 ml - Prod. 6 pcs
Layout 2 x 3

30SF103

Bordelais ø 55



ø 55 h 50
Vol. ~ 92 ml - Prod. 8 pcs
Layout 4 x 2

30SF050

Bordelais ø 45



ø 45 h 45
Vol. ~ 60 ml - Prod. 15 pcs
Layout 5 x 3

30SF059

Flan ø 80



ø 80 h 18
Vol. ~ 72 ml - Prod. 6 pcs
Layout 3 x 2

30SF047

Flan ø 70



ø 70 h 17
Vol. ~ 52 ml - Prod. 6 pcs
Layout 3 x 2

30SF046

Flan ø 60



ø 60 h 17
Vol. ~ 42 ml - Prod. 8 pcs
Layout 4 x 2

30SF045

MINI PORTIONS/MINI PORZIONI

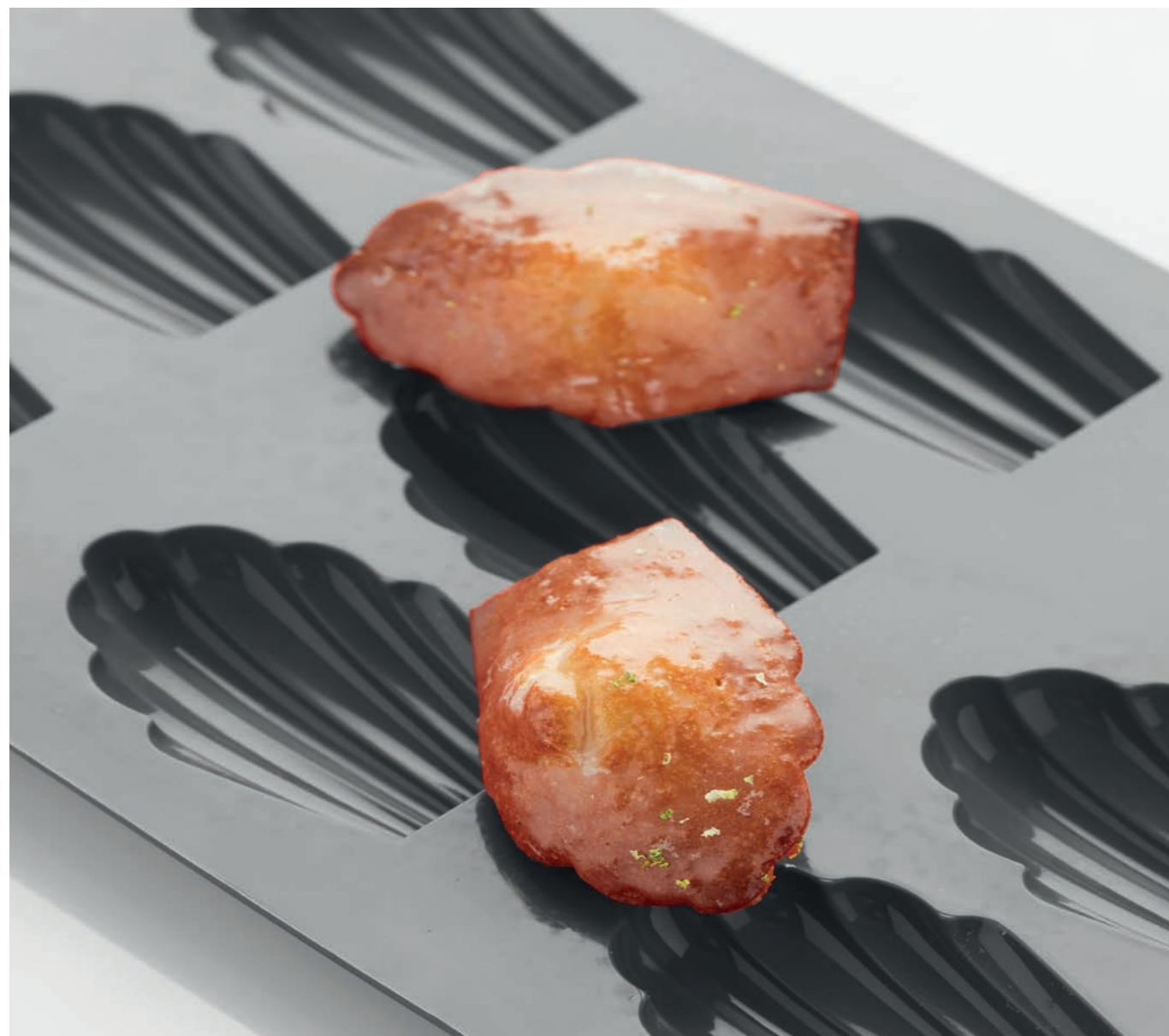

Madeleine 68

68 x 45 h 17
Vol. ~ 30 ml - Prod. 9 pcs
Layout 3 x 3

30SF032

Madeleine 44

44 x 34 h 10
Vol. ~ 10 ml - Prod. 15 pcs
Layout 5 x 3

30SF031

Tartlet ø 50



ø 50 / ø 32 h 15
Vol. ~ 25 ml - Prod. 15 pcs
Layout 5 x 3

30SF014

Tartlet ø 45



ø 45/ø 28 h 10
Vol. ~ 20 ml - Prod. 15 pcs
Layout 5 x 3

30SF013

Cylinder ø 40



ø 40 h 20
Vol. ~ 30 ml - Prod. 15 pcs
Layout 5 x 3

30SF027

Pomponette



ø 34 h 16
Vol. ~ 18 ml - Prod. 24 pcs
Layout 6 x 4

30SF009

Pyramid 36



36 x 36 h 22
Vol. ~ 20 ml - Prod. 15 pcs
Layout 5 x 3

30SF008

Oval



55 x 33 h 20
Vol. ~ 30 ml - Prod. 16 pcs
Layout 4 x 4

30SF017

Flan ø 50

ø 50 h 14
Vol. ~ 23 ml - Prod. 15 pcs
Layout 5 x 3

30SF044**Fiorentine ø 60**

ø 60 h 12
Vol. ~ 35 ml - Prod. 8 pcs
Layout 4 x 2

30SF029**Fiorentine ø 35**

ø 35 h 5
Vol. ~ 10 ml - Prod. 24 pcs
Layout 6 x 4

30SF030**Bordelais ø 35**

ø 35 h 35
Vol. ~ 30 ml - Prod. 18 pcs
Layout 6 x 3

30SF033**Octagon**

ø 38 h 26
Vol. ~ 30 ml - Prod. 15 pcs
Layout 5 x 3

30SF037**Savarin ø 10**

ø 41 h 12
Vol. ~ 18 ml - Prod. 18 pcs
Layout 6 x 3

30SF010**Babà ø 35**

ø 35 h 38
Vol. ~ 30 ml - Prod. 15 pcs
Layout 5 x 3

30SF019**Pastille**

ø 27 h 11
Vol. ~ 6 ml - Prod. 40 pcs
Layout 8 x 5

30SF180**Éclair**

125 x 28 h 5
Vol. ~ 15 ml - Prod. 8 pcs
Layout 2 x 4

30SF161**Diamond ø 35**

ø 35 h 23
Vol. ~ 20 ml - Prod. 18 pcs
Layout 6 x 3

30SF048**Financier 49**

49 x 26 h 11
Vol. ~ 20 ml - Prod. 20 pcs
Layout 5 x 4

30SF025

Half Sphere ø 80

ø 80 h 40
Vol. ~ 120 ml - Prod. 5 pcs

30SF001**Half Sphere ø 70**

ø 70 h 35
Vol. ~ 80 ml - Prod. 6 pcs
Layout 3 x 2

30SF002**Half Sphere ø 60**

ø 60 h 30
Vol. ~ 60 ml - Prod. 6 pcs
Layout 3 x 2

30SF003**Half Sphere ø 50**

ø 50 h 25
Vol. ~ 30 ml - Prod. 8 pcs
Layout 4 x 2

30SF004**Half Sphere ø 45**

ø 45 h 22.5
Vol. ~ 24 ml - Prod. 15 pcs
Layout 5 x 3

30SF500**Half Sphere ø 40**

ø 40 h 20
Vol. ~ 20 ml - Prod. 15 pcs
Layout 5 x 3

30SF005**Half Sphere ø 35**

ø 35 h 17.5
Vol. ~ 11 ml - Prod. 18 pcs
Layout 6 x 4

30SF501**Half Sphere ø 30**

ø 30 h 15
Vol. ~ 10 ml - Prod. 24 pcs
Layout 6 x 4

30SF006**Half Sphere ø 25**

ø 25 h 12.5
Vol. ~ 4 ml - Prod. 28 pcs
Layout 7 x 4

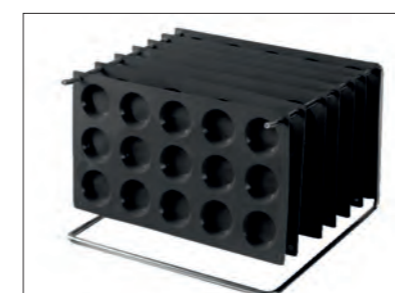
30SF502

Drying rack for silicone moulds
Sgocciolatore per stampi in silicone

DRIP

HIGH PRODUCTIVITY/ALTA PRODUTTIVITÀ 595 X 395 MM

Silicone moulds 595 x 395 mm/Stampi in silicone 595 x 395 mm.



Muffins ø 69

ø 69 h 39 mm
Vol. ~ 120 ml - Prod. 24 pcs
Layout 6 x 4

30SIL07N



Mini Muffins ø 50

ø 50 h 28 mm
Vol. ~ 40 ml - Prod. 54 pcs
Layout 9 x 6

30SIL06N



Sphere ø 70

ø 70 h 35 mm
Vol. ~ 90 ml - Prod. 24 pcs
Layout 6 x 4

30SIL04N



Mini Sphere ø 35

ø 35 h 17,5 mm
Vol. ~ 10 ml - Prod. 96 pcs
Layout 12 x 8

30SIL05N

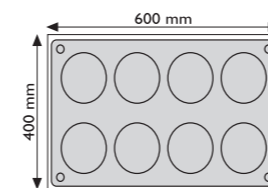

A 60 x 40 baking tray
can accommodate 1 mould.
*Una teglia 60 x 40 può
contenere 1 stampo.*



Love

75 x 68 x h 30 mm
Vol. ~ 90 ml - Prod. 24 pcs
Layout 6 x 4

30SIL03N



Donuts

ø 75 h 25 mm
Vol. ~ 90 ml - Prod. 24 pcs
Layout 6 x 4

30SIL01N



Eclair

130 x 30 x h 28 mm
Vol. ~ 85 ml - Prod. 28 pcs
Layout 4 x 7

30SIL02N



Madeleine

74 x 45 x h 18 mm
Vol. ~ 35 ml - Prod. 44 pcs
Layout 11 x 4

30SIL08N



SEMIFREDDO MOULDS





THE FUTURE IS IN ONE MOVE

A new generation of Made in Italy moulds that are changing the way work is done in the laboratory. Practical, economical, and fast, disposable plastic moulds for cakes and individual cakes speed up the production of semifreddo, saving time, reducing costs, eliminating the use of detergents, and cutting water consumption due to cleaning. One Strip is 100% recyclable.

Una nuova generazione di stampi Made in Italy che stanno cambiando il modo di lavorare in laboratorio.

Pratici, economici e veloci, gli stampi monouso in plastica per torte e individual cake consentono di velocizzare la produzione di semifreddi, risparmiando tempo, riducendo i costi, eliminando l'uso di detergenti e il consumo di acqua dovuto ai lavaggi.

One Strip è riciclabile al 100%.

Recommended by
Luigi Biassetto
Champions du Monde



-30% PRODUCTION TIME

- 30% TEMPO DI PRODUZIONE

-15% MATERIAL COST

- 15% COSTO DEL MATERIALE

-20% LABOUR COST

- 20% COSTO DI MANODOPERA

-25% CONSUMPTIONS

- 25% CONSUMI

100% RECYCLABLE



One Strip Cake

Cod.	Size	Vol.	Pack
ONE14H35	ø 140 h 35 mm	~ 450 ml	140 pcs
ONE14H40	ø 140 h 40 mm	~ 600 ml	140 pcs
ONE16	ø 160 h 40 mm	~ 800 ml	100 pcs
ONE18	ø 180 h 40 mm	~ 1000 ml	100 pcs
ONE20	ø 200 h 40 mm	~1250 ml	100 pcs
ONE22	ø 220 h 40 mm	~ 1500 ml	100 pcs

One Strip Individual

6 pcs/bar

Prod. for 60 x 40 tray: 6 x 9 bars = 54 pcs.

Prod. su teglia 60 x 40: 6 x 9 bars = 54 pcs.

Cod.	Size	Vol.	Pack
ONE06	ø 63 h 40 mm	~ 120 ml x 6	72 bars

SINGLE PORTION & MIGNON BAR MOULDS

Plastic bars for the production of single portions and mignon. The rigid material provides stability for greater precision in preparation and ease of handling during processing.

The plastic bars for semifreddo are easy to fill. The extractor simplifies and speeds up the demolding of the dessert even if not completely frozen. The insertion of acetate protects the edges of the single portion during extraction from the mold and preserves the product during storage and display. Extractor and pastry cutter available for separate purchase.

Barre in plastica per la produzione di monoporzioni e mignon. Il materiale rigido conferisce stabilità per una maggior precisione nella preparazione e maneggiabilità durante la lavorazione.

Le barre in plastica per semifreddi sono facili da riempire. L'estrattore semplifica e velocizza lo smodellamento del dessert anche se non completamente congelato. L'inserimento dell'acetato protegge i bordi della monoporzione durante l'estrazione dallo stampo e conserva il prodotto durante lo stoccaggio e l'esposizione. Estrattore e tagliapasta acquistabili separatamente.

Watch
the video



MIGNON BARS/BARRE PER MIGNON



Circle

Mignon: ø 42,5 h 25 mm - Vol ~ 23 ml

Cod.	Prod.	Tray Vassoio	Bars Barre
MIGNON A001	32 pcs	20 x 40 cm	2
MIGNON B001	48 pcs	30 x 40 cm	3
MIGNON C001	96 pcs	60 x 40 cm	6

Cod.

ED 1 Extractor/estrattore Circle

TPM 1 Cutter/tagliapasta Circle

Oval

Mignon: 53 x 32 x h 25 mm - Vol ~ 33 ml

Cod.	Prod.	Tray Vassoio	Bars Barre
MIGNON A002	32 pcs	20 x 40 cm	2
MIGNON B002	48 pcs	30 x 40 cm	3
MIGNON C002	96 pcs	60 x 40 cm	6

Cod.

ED 2 Extractor/estrattore Oval

TPM 2 Cutter/tagliapasta Oval

SINGLE PORTIONS BARS/BARRE PER MONOPORZIONI



Circle

Single portion: \varnothing 65 h 40 mm - Vol ~ 133 ml

Cod.	Prod.	Tray Vassoio	Bars Barre
MONOP. A001	10 pcs	17 x 40 cm	2
MONOP. B001	15 pcs	26 x 40 cm	3
MONOP. C001	35 pcs	60 x 40 cm	7

Cod.			
EM 1	Extractor/estrattore Circle		
TPG 1	Cutter/tagliapasta Circle		

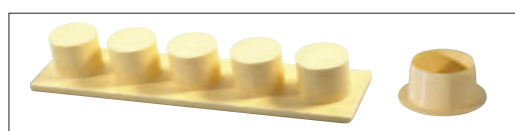

Oval

Single portion: 87 x 51 x h 40 mm - Vol ~ 139 ml

Cod.	Prod.	Tray Vassoio	Bars Barre
MONOP. A002	10 pcs	17 x 40 cm	2
MONOP. B002	15 pcs	26 x 40 cm	3
MONOP. C002	35 pcs	60 x 40 cm	7

Cod.			
EM 2	Extractor/estrattore Oval		
TPG 2	Cutter/tagliapasta Oval		



Square

Single portion: 59 x 59 x h 40 mm - Vol ~ 139 ml

Cod.	Prod.	Tray Vassoio	Bars Barre
MONOP. A005	10 pcs	17 x 40 cm	2
MONOP. B005	15 pcs	26 x 40 cm	3
MONOP. C005	35 pcs	60 x 40 cm	7

Cod.			
EM 5	Extractor/estrattore Square		
TPG 5	Cutter/tagliapasta Square		

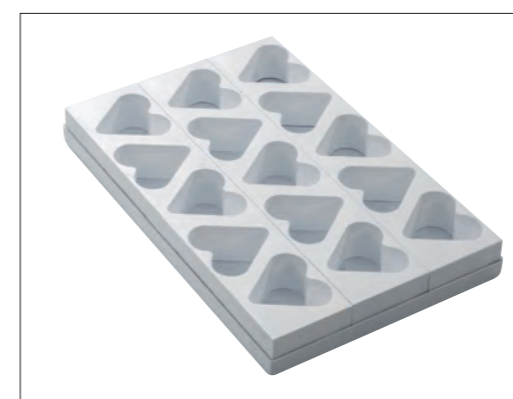
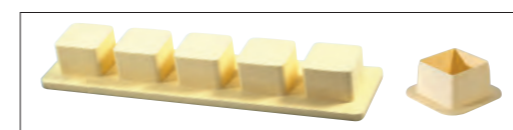

Heart

Single portion: 78,5 x 72,5 x h 40 mm - Vol ~ 143 ml

Cod.	Prod.	Tray Vassoio	Bars Barre
MONOP. A007	10 pcs	17 x 40 cm	2
MONOP. B007	15 pcs	26 x 40 cm	3
MONOP. C007	35 pcs	60 x 40 cm	7

Cod.			
EM 7	Extractor/estrattore Heart		
TPG 7	Cutter/tagliapasta Heart		

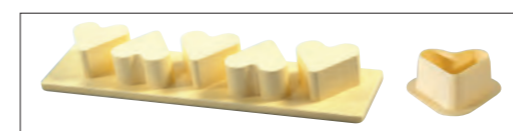

Drop

Single portion: 89 x 57,5 x h 40 mm - Vol ~ 138 ml

Cod.	Prod.	Tray Vassoio	Bars Barre
MONOP. A008	10 pcs	17 x 40 cm	2
MONOP. B008	15 pcs	26 x 40 cm	3
MONOP. C008	35 pcs	60 x 40 cm	7

Cod.			
EM 8	Extractor/estrattore Drop		
TPG 8	Cutter/tagliapasta Drop		

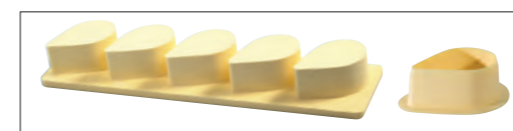

ACETATE ROLLS & SHEETS/NASTRI & FOGLI ACETATI

Sheets and ribbons in easy-to-use acetate for lining moulds and creating and shaping single portions and mignons with non-stick properties. Suitable for cooling in blast chillers, freezers, and refrigerators, they are extra transparent, super resistant, and made with high-quality material.

Fogli e nastri in acetato facili da usare per rivestire stampi e per realizzare e sfornare monoporzioni e mignon grazie alle proprietà antiaderenti. Sono adatti al raffreddamento in abbattitore, congelatore e frigo e sono extra trasparenti, super resistenti e prodotti con materiale di alta qualità.



Thickness 80 µm, core ø 76 mm. Suitable for 50MC001 MartCutter ribbon cutter.
Spessore 80 µm, anima ø 76 mm.
Adatti per taglianastri MartCutter 50MC001.

Acetate rolls Nastri acetati

Cod.	Height Altezza	µm	Length Lungh.	External size Misura esterna
NSA H 25	h 23 mm	80	305 mt	ø 210 mm
NSA H 30	h 30 mm	80	305 mt	ø 210 mm
NSA H 35	h 35 mm	80	305 mt	ø 210 mm
NSA H 40	h 38 mm	80	305 mt	ø 210 mm
NSA H 45	h 45 mm	80	305 mt	ø 210 mm
NSA H 50	h 50 mm	80	305 mt	ø 210 mm
NSA H 55	h 55 mm	80	305 mt	ø 210 mm
NSA H 60	h 60 mm	80	305 mt	ø 210 mm



Acetate sheets Fogli acetati

Other sizes and thicknesses on request.
Altre misure e spessori disponibili su richiesta.

Cod.	Size	µm	Pack
NSA300X300	300 x 300 mm	80	50 pcs
NSA400X600	388 x 588 mm	80	50 pcs



Guitar sheets Fogli chitarra

Other sizes and thicknesses on request.
Altre misure e spessori disponibili su richiesta.

Cod.	Size	µm	Pack
NSA27X27MO	270 x 270 mm	75	100 pcs
NSA39X39MO	390 x 390 mm	75	100 pcs
NSA60X40MO	590 x 390 mm	120	50 pcs



Acetate strips Strisce acetate

Cod.	Size	µm	Pack
NSA25X150	150 h 23 mm	80	1.000 pcs
NSA30X240	240 h 30 mm	80	1.000 pcs
NSA40X240	240 h 38 mm	80	1.000 pcs

BAKING EQUIPMENT



TRAVEL CAKE GEOMETRIC MOULDS

Stainless steel moulds for making classic or modernly decorated travel cakes. In some models, the tubular insert, easily removable after baking, allows for creatively filling the cakes with non-bake fillings.

Stampi in acciaio inox per realizzare travel cake classici o decorati in chiave moderna. In alcuni modelli l'inserito tubolare, facilmente estraibile dopo la cottura, consente di farcire in modo creativo i dolci anche con ripieni non da forno.

Designed in
collaboration with



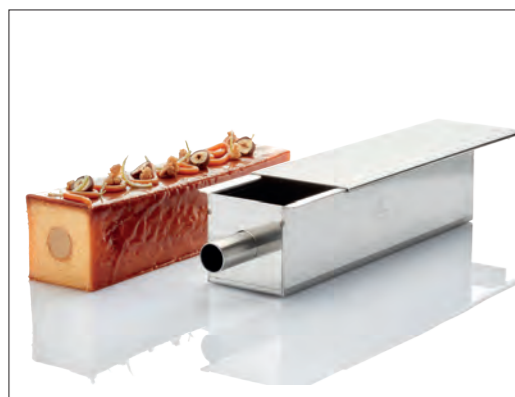

Carrè

Production on 60 x 40 tray: small 10 pcs - big 8 pcs
 Produzione su teglia 60 x 40: small 10 pcs - big 8 pcs

Cod.	Mould/Stampo	Cake/Dolce	Vol.
30TC50F	103 x 190 h 70 mm	80 x 150 h 69 mm	850 ml
30TC51F	82 x 290 h 64 mm	60 x 250 h 60 mm	900 ml



Round

Production on 60 x 40 tray: 8 pcs
 Produzione su teglia 60 x 40: 8 pcs

Cod.	Mould/Stampo	Cake/Dolce	Vol.
30TC54F	ø 82 x 290 mm	ø 78 x 250 mm	1050 ml



Triangle

Production on 60 x 40 tray: 6 pcs
 Produzione su teglia 60 x 40: 6 pcs

Cod.	Mould/Stampo	Cake/Dolce	Vol.
30TC52F	88 x 290 h 85 mm	82 x 250 h 80 mm	890 ml

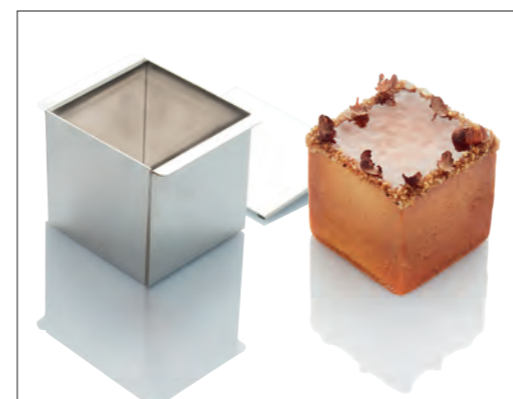

Cubò

Production on 60 x 40 tray: 20 pcs
 Produzione su teglia 60 x 40: 20 pcs

Cod.	Mould/Stampo	Cake/Dolce	Vol.
30TC55	103 x 86 h 83 mm	80 x 80 h 80 mm	510 ml



Fancy

Production on 60 x 40 tray: 8 pcs
 Produzione su teglia 60 x 40: 8 pcs

Cod.	Mould/Stampo	Cake/Dolce	Vol.
30TC53F	83,5 x 290 h 86 mm	60 x 250 h 80 mm	960 ml



Block & Oval

Production on 60 x 40 tray: 8 pcs
 Produzione su teglia 60 x 40: 8 pcs

Cod.	Mould/Stampo	Cake/Dolce	Vol.
30TC56	255 x 84 h 62 mm	250 x 60 h 60 mm	Oval: 790 ml Block: 900 ml

MICROPERFORATED BANDS, MOULDS & MATS

Non-stick, micro-perforated silicone mats, bands and moulds. The micro-perforation allows the heat to spread evenly and the humidity to escape, reduces baking times and guarantees a perfect result.

Tappeti, fasce e stampi in silicone microforato antiaderente.

La microforatura consente la diffusione uniforme del calore e l'uscita dell'umidità, riduce i tempi di cottura e garantisce un risultato perfetto.



MICRO-PERFORATED BANDS/FASCE MICROFORATE

Micro-perforated silicone bands with fiberglass, which combined with the stainless steel moulds, guarantee even cooking without humidity, easy demoulding without breakings and a regular and elegant texture.

Fasce in silicone microforato con fibra di vetro, che abbinare agli stampi in acciaio inox, garantiscono cottura omogenea e senza umidità, sfomatatura facile senza rotture e una texture regolare ed elegante.

- Even cooking with zero imperfections
 - Adaptability to all shapes and recipes
 - Quick demoulding without breakings
 - Elegant and exclusive textures
 - Quick washing and drying
 - Minimal storage
 - Resistant up to + 230°C
- *Cottura omogenea e senza imperfezioni*
 - *Adattabilità a tutte le forme e ad ogni ricetta*
 - *Sfomatatura veloce e senza rotture*
 - *Texture elegante ed esclusiva*
 - *Lavaggio e asciugatura veloce*
 - *Minimo spazio di stoccaggio*
 - *Resistente fino a + 230°C*



Find the perfect stainless steel band at page 285.

Trova la perfetta fascia inox a pag. 285.



Designed in collaboration with Denis Dianin

iMicroforati bands

Cod.	Size	Pack	St. steel band Fascia inox
30BANDS01	500 h 25 mm	10 pcs	ø 14- 16 h 2,5
30BANDS02	625 h 25 mm	10 pcs	ø 18- 20 h 2,5
30BANDS03	750 h 25 mm	10 pcs	ø 22- 24 h 2,5
30BANDS04	500 h 35 mm	10 pcs	ø 14- 16 h 3,5
30BANDS05	625 h 35 mm	10 pcs	ø 18- 20 h 3,5
30BANDS06	750 h 35 mm	10 pcs	ø 22- 24 h 3,5
30BANDS07	260 h 20 mm	20 pcs	ø 8 h 2 cm

Watch the video



MICRO-PERFORATED MOULDS/STAMPI MICROFORATI

The micro-perforation allows the heat to spread evenly and the humidity to escape, reduces baking times and guarantees a perfect result. The line of silicone baking moulds "i Microforati" offers many shapes ideal for different preparations, both sweet and savoury, such as classic and modern tartlets, brioche and muffins. The creations will result perfectly crispy and with the perfect shape, without bubbles or sagging. The professional silicone moulds are also ideal for leavened products, shortcrust pastry and brisé. The material of which the silicone mould is made is non-stick and can be used on both sides, to prepare empty or already filled tartlets. Every package contains 2 moulds 30 x 40 cm.

La microforatura consente la diffusione uniforme del calore e l'uscita dell'umidità, riduce i tempi di cottura e garantisce un risultato perfetto. La linea di stampi da forno in silicone "i Microforati" propone tante forme ideali per le diverse preparazioni, sia dolci che salate, come tartellette classiche e moderne, brioche e muffin. Le creazioni risulteranno perfettamente croccanti e con la forma perfetta, senza bolle o cedimenti. Gli stampi in silicone professionali sono ideali anche per i lievitati, pasta frolla e brisé. Il materiale di cui è composto lo stampo in silicone è antiaderente e può essere usato da entrambi i lati, per preparare tartellette vuote o già farcite. Ogni confezione contiene 2 stampi 30 x 40 cm.

- Perfectly crispy creations
- Perfect shape, without bubbles or sagging
- Moulds can be used on both sides
- Non-stick material allows easily demoulding
- Resistant up to + 230°C
- Creazioni perfettamente croccanti
- Forma perfetta, senza bolle o cedimenti
- Gli stampi possono essere usati da entrambi i lati
- Sformatura facile grazie al materiale antiaderente
- Resistente fino a + 230°C



iMicroforati - Square

Cod.	Cavity size Dimensione alveolo	Prod
30MICRO06	35 x 35 h 16 mm	30 + 30 pcs
30MICRO07	50 x 50 h 20 mm	20 + 20 pcs
30MICRO08	85 x 85 h 20 mm	6 + 6 pcs



iMicroforati - Triangle

Cod.	Cavity size Dimensione alveolo	Prod
30MICRO09	60 h 25 mm	15 + 15 pcs



iMicroforati - Round

Cod.	Cavity size Dimensione alveolo	Prod
30MICRO01	ø 40 h 16 mm	24 + 24 pcs
30MICRO10	ø 48 h 22 mm	20 + 20 pcs
30MICRO02	ø 50 h 16 mm	20 + 20 pcs
30MICRO03	ø 60 h 40 mm	12 + 12 pcs
30MICRO04	ø 85 h 20 mm	6 + 6 pcs
30MICRO05	ø 120 h 30 mm	4 + 4 pcs



iMicroforati - Eclair

Cod.	Cavity size Dimensione alveolo	Prod
30MICRO11	ø 120 h 6 mm	16 + 16 pcs

MICRO-PERFORATED MATS/TAPPETI MICROFORATI

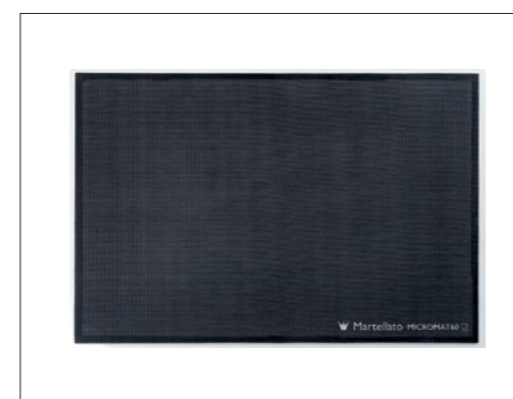

Micro-perforated mat Tappeti microforati

Made of silicone with fiberglass. Resistant up to + 230°C.
Silicone con fibra di vetro. Resistente fino a + 230°C.

Cod.	Size
MICROMAT30	385 x 285 mm
MICROMAT60	385 x 585 mm

MICROPAPER
Let your creations breathe

THE FIRST MICRO-PERFORATED BAKING PAPER

Ideal for baking all leavened doughs, perfect for cooking cream puffs, shortcrust pastry, cookies, puff pastry, and meringues, ensuring perfect baking in less time than traditional baking paper. Microperforation allows steam to escape more quickly during baking and ensures better air passage, cooling products faster than traditional baking paper.

Ideale per la cottura di tutte le paste lievitate, è perfetta per cucinare anche bignè, pasta frolla, biscotti, pasta sfoglia e meringhe, garantisce una cottura perfetta in minor tempo rispetto alla carta da forno tradizionale. La microforatura, consente al vapore acqueo di fuoriuscire più velocemente durante la cottura e garantisce un miglior passaggio dell'aria, che raffredda anche i prodotti più velocemente rispetto alla carta forno tradizionale.

Developed
 from an idea of



Watch
 the video



MICROPAPER IS IDEAL FOR BAKING

- Cream puff
Bignè
- Bread
Pane
- Biscuits
Biscotti
- Puff pastry
Pasta sfoglia
- Pizza
Pizza
- Fonsage tart
Fonsage tart
- Shortcrust pastry
Pasta frolla
- Focaccia bread
Focacce
- Leavened doughs
Paste lievitate
- Brisée pastry
Pasta brisée
- Crumble and streusel
Crumble e streusel
- Leavened puff pastries
Paste lievitate sfogliate



FASTER BAKING

COTTURA PIÙ RAPIDA

FASTER CHILLING

RAFFREDDAMENTO PIÙ VELOCE

UNIFORM AIR FLOW

FLUSSO D'ARIA UNIFORME

ENERGY & TIME SAVINGS

RISPARMIO DI TEMPO & ENERGIA



MicroPaper

Cod.	Size	Pack
51MP6040	592 x 392 mm	200 pcs

BAKING TRAYS/TEGLIE FORNO



Aluminum tray Teglie in alluminio

Cod.	Size	Thickness Spessore	Edges Bordi
53TA60404	60 x 40 h 2 cm	1,5 mm	4



Perforated aluminum tray Teglie forate in alluminio

Cod.	Size	Thickness Spessore	Edges Bordi
53TAF40302	40 x 30 h 2 cm	1,5 mm	2 (on long side/sul lato lungo)
53TAF40304	40 x 30 h 2 cm	1,5 mm	4
53TAF60404	60 x 40 h 2 cm	1,5 mm	4



Aluminized tray Teglie alluminate

Cod.	Size	Thickness Spessore	Edges Bordi
53TL60404	60 x 40 h 2 cm	0,8 mm	4

BAKING SUPPORTS/SUPPORTI PER COTTURA



Baking paper Carta forno

Cod.	Size	Pack
51CF6040	600 x 400 mm	500 pcs



Non stick mat Tappeto antiaderente

Made of PTFE.
In PTFE.

Cod.	Size	Pack
TEFLONPAT5	590 x 390 mm	5 pcs

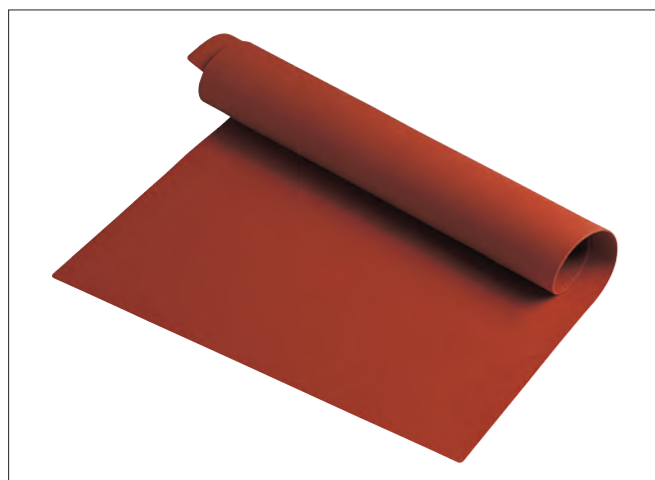

Silicone mat Tappeto in silicone

Non-stick silicone mats for baking and freezing.
Tappeti antiaderenti in silicone per cottura e surgelazione.

Cod.	Size
SILICOPAT1/R	395 x 595 mm
SILICOPAT2/R	310 x 510 mm
SILICOPAT6/R	360 x 430 mm
SILICOPAT7/R	300 x 400 mm



Eclair silicone mat Tappeto eclair silicone

Cod.	Size	Prod.	Eclair
30TE3001R	29,8 x 39,8 cm	18 pcs	25 x 125 mm
30TE6001R	58,5 x 38,6 cm	36 pcs	25 x 125 mm
30TE3002R	29,8 x 39,8 cm	35 pcs	18 x 60 mm
30TE6002R	58,5 x 38,6 cm	70 pcs	18 x 60 mm

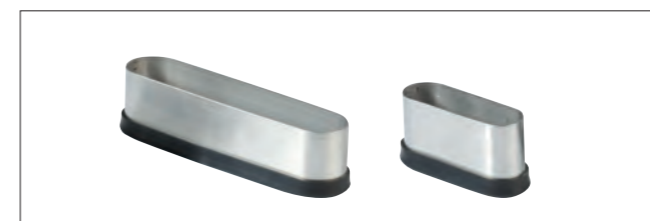

Cod.	
31CUT01	St. steel cutter/tagliapasta acciaio inox 25 x 125 mm
31CUT02	St. steel cutter/tagliapasta acciaio inox 18 x 60 mm



Silicone + fiberglass mat Silicone + fibra di vetro

Non-stick silicone mats with fiberglass for baking and freezing. Ideal to work with sugar.
Tappeti antiaderenti in silicone e fibra di vetro per cottura e surgelazione. Ideali per la lavorazione dello zucchero.

Cod.	Size
SILICOPAT1/B	390 x 590 mm
SILICOPAT2/B	310 x 510 mm
SILICOPAT3/B	620 x 420 mm
SILICOPAT4/B	790 x 590 mm



Macaron silicone mat Tappeto macaron silicone

Cod.	Size	Prod.	Macaron
30TM3001R	30 x 40 cm	34 pcs	ø 40 mm
30TM6001R	58,5 x 38,6 cm	70 pcs	ø 40 mm

SILICONE BAKING PAN/TORTIERE IN SILICONE

Heart

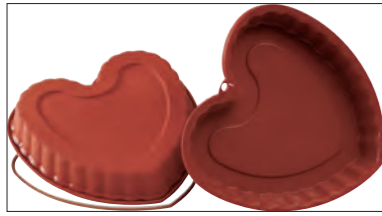

Cod.	Size (mm)	Vol (ml)
SFT 210/Y	220 x 218 h 30	1250

Marguerite

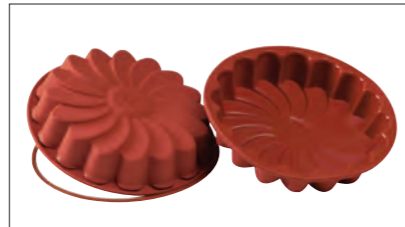

Cod.	Size (mm)	Vol (ml)
SFT 220/Y	ø 220 h 45	1300

Savarin

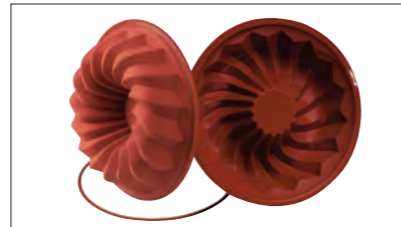

Cod.	Size (mm)	Vol (ml)
SFT 224/Y	ø 240 h 60	1250

Rose

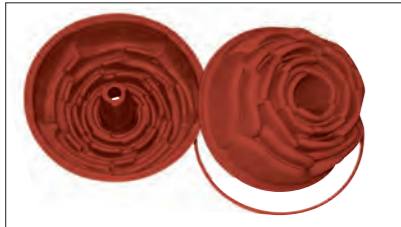

Cod.	Size (mm)	Vol (ml)
SFT 251/Y	ø 220 h 100	2250

Brioche

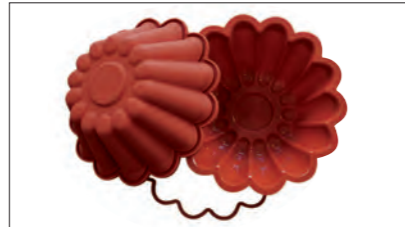

Cod.	Size (mm)	Vol (ml)
SFT 522/Y	ø 220 h 80	1700

Star bundt

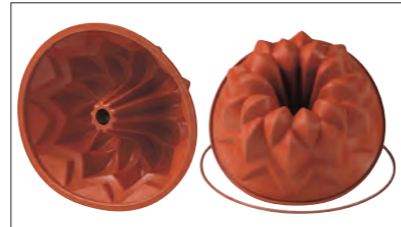

Cod.	Size (mm)	Vol (ml)
SFT 600/Y	ø 240 h 100	2300

Rectangular



Cod.	Size (mm)	Vol (ml)
SFT 300/Y	280 x 220 h 40	1300

Gugelhopf no ring senza anello

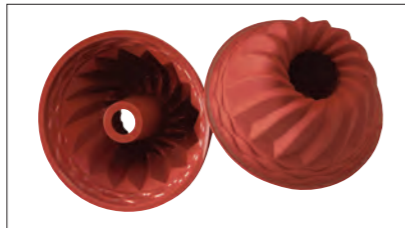

Cod.	Size (mm)	Vol (ml)
SFT 250/Y	ø 220 h 110	2200

Round



Cod.	Size (mm)	Vol (ml)
SFT 118/Y	ø 180 h 40	1000
SFT 120/Y	ø 200 h 40	1050
SFT 122/Y	ø 220 h 42	1400
SFT 124/Y	ø 240 h 42	1700
SFT 126/Y	ø 260 h 45	2200
SFT 128/Y	ø 280 h 45	2500

Plum Cake



Cod.	Size (mm)	Vol (ml)
SFT 326/Y	240 x 105 h 65	1500
SFT 330/Y	260 x 100 h 70	1550

Flan



Cod.	Size (mm)	Vol (ml)
SFT 424/Y	ø 240 h 30	1250
SFT 426/Y	ø 260 h 30	1300
SFT 428/Y	ø 280 h 30	1750

Suitable from - 60°C up to + 230°C.
Adatte da - 60°C a + 230°C.

JELLY MOULDS/STAMPI GELATINE

Jelly moulds, in pure food-grade silicone, for making fruit jellies, fondants, etc. Plastic frame. Mould: 180 x 335 mm. Layout 8 x 3.

Stampi per gelatine, in puro silicone alimentare, per la realizzazione di gelatine alla frutta, fondenti, ecc. Cornice in plastica. Stampo: 180 x 335 mm. Layout 8 x 3.

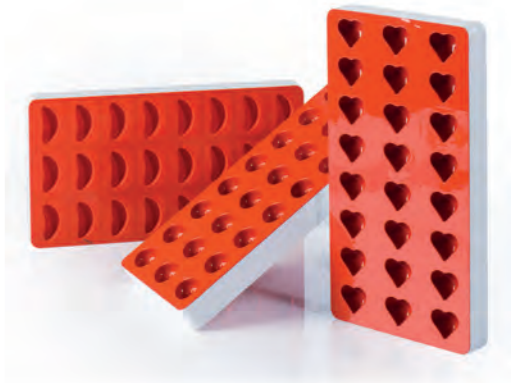

Heart



Cod.	Jelly size (mm)	Prod
SG 03	34 x 30 h 18	24

Orange slice



Cod.	Jelly size (mm)	Prod
SG 01	45 x 18 h 15	24

Pineapple



Cod.	Jelly size (mm)	Prod
SG 07	33 x 23 h 18	24

Strawberry



Cod.	Jelly size (mm)	Prod
SG 08	30 x 30 h 20	24

Peach



Cod.	Jelly size (mm)	Prod
SG 09	35 x 25 h 20	24

Berry



Cod.	Jelly size (mm)	Prod
SG 06	ø 30 h 24	24

Pear



Cod.	Jelly size (mm)	Prod
SG 02	40 x 26 h 15	24

Bon bon



Cod.	Jelly size (mm)	Prod
SG 05	ø 30 h 11	24

Half-sphere

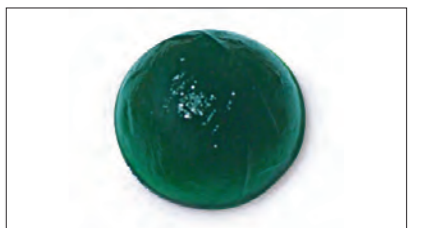

Cod.	Jelly size (mm)	Prod
SG 04	ø 27 h 13,5	24

SAN MARTINO



San Martino

Plastic mould.
Stampo in plastica.

Cod.	Mould/Stampo	Cake/Dolce
SMA110	170 x 190 mm	110 x 125 mm
SMA180	230 x 260 mm	180 x 200 mm
SMA260	295 x 330 mm	245 x 270 mm

LOG MOULDS/STAMPI TRONCHETTO

Plastic moulds.
Stampi in plastica.



Classic

Cod.	Size
30TT104S	400 x 100 h 60 mm



Dome

Cod.	Size
ST 2	480 x 65 h 50 mm
ST 4	480 x 50 h 40 mm



Triangular

Cod.	Size
ST 1	480 x 65 h 65 mm

PASTRY RING



PASTRY RING

High-quality stainless steel bands with perfectly straight edges, thick for greater rigidity, and a smooth surface for easy demoulding and impeccable desserts. Suitable for use in the oven, ensuring even cooking, as well as in the freezer and blast chiller for complete and fast cooling. The variety of shapes and sizes, combined with extensive customization possibilities upon request, make Martellato bands versatile solutions that can satisfy even the most demanding pastry chefs.

Fasce in acciaio inox di alta qualità con bordi perfettamente dritti, spessi per maggiore indeformabilità e superficie liscia per facilità di sfornatura e dessert impeccabili. Adatti all'utilizzo sia in forno, dove assicurano cottura uniforme che in congelatore ed in abbattitore, per un completo e veloce raffreddamento. La varietà di forme e dimensioni, unita alle ampie possibilità di personalizzazione del soggetto su richiesta, rendono le fasce Martellato delle soluzioni versatili in grado di soddisfare anche i pasticceri più esigenti.





Quenelle

Cod.	Size	Vol.
48H4X18	92 x 182 h 40 mm	~ 440 ml
48H4X23	124 x 227 h 40 mm	~ 750 ml
48H4X25	142 x 249 h 40 mm	~ 1000 ml



Calisson

Cod.	Size	Vol.
41H4X9	90 x 50 h 40 mm	~ 120 ml
41H4X15	150 x 80 h 40 mm	~ 350 ml
41H4X22	220 x 120 h 40 mm	~ 750 ml



Pillow

Cod.	Size	Vol.
46H4X18	67 x 182 h 40 mm	~ 360 ml
46H4X21	94 x 209 h 40 mm	~ 600 ml
46H4X27	121 x 270 h 40 mm	~ 1000 ml



Tris

Cod.	Size	Vol.
47H4X15	146 x 134 h 40 mm	~ 510 ml
47H4X17	170 x 159 h 40 mm	~ 750 ml
47H4X20	197 x 184 h 40 mm	~ 1000 ml



Stripe

Cod.	Size	Vol.
49H4X25	62 x 252 h 40 mm	~ 600 ml
49H4X27	81 x 272 h 40 mm	~ 850 ml
49H4X29	92 x 292 h 40 mm	~ 1000 ml



Donut

Cod.	Size	Vol.
43H4X18	ø 180 ø 100 h 40 mm	~ 710 ml
43H4X20	ø 200 ø 120 h 40 mm	~ 810 ml



Diamond Heart

Cod.	Size	Vol.
45H4X15	150 x 138 h 40 mm	~ 550 ml
45H4X19	186 x 171 h 40 mm	~ 850 ml
45H4X20	202 x 184 h 40 mm	~ 1000 ml



Diamond Circle

Cod.	Size	Vol.
44H4X14	ø 144 h 40 mm	~ 600 ml
44H4X17	ø 171 h 40 mm	~ 850 ml
44H4X20	ø 202 h 40 mm	~ 1200 ml



Fancy

Cod.	Size	Vol.
23H4X25	250 x 90 h 40 mm	~ 900 ml
23H4X30	300 x 91 h 40 mm	~ 1000 ml
23H4X35	350 x 92 h 40 mm	~ 1290 ml
23H5X25	250 x 90 h 50 mm	~ 1100 ml
23H5X30	300 x 91 h 50 mm	~ 1350 ml
23H5X35	350 x 92 h 50 mm	~ 1600 ml



Heart

Cod.	Size	Vol.
42H4X10	ø 100 h 40 mm	~ 250 ml
42H4X12	ø 120 h 40 mm	~ 360 ml
42H4X14	ø 140 h 40 mm	~ 490 ml
42H4X16	ø 160 h 40 mm	~ 650 ml
42H4X18	ø 180 h 40 mm	~ 820 ml
42H4X20	ø 200 h 40 mm	~ 1020 ml
42H4X22	ø 220 h 40 mm	~ 1240 ml
42H4X24	ø 240 h 40 mm	~ 1480 ml
42H4X26	ø 260 h 40 mm	~ 1730 ml
42H4X28	ø 280 h 40 mm	~ 2030 ml

Cod.	Size	Vol.
42H5X10	ø 100 h 50 mm	~ 310 ml
42H5X12	ø 120 h 50 mm	~ 450 ml
42H5X14	ø 140 h 50 mm	~ 620 ml
42H5X16	ø 160 h 50 mm	~ 820 ml
42H5X18	ø 180 h 50 mm	~ 1030 ml
42H5X20	ø 200 h 50 mm	~ 1280 ml
42H5X22	ø 220 h 50 mm	~ 1550 ml
42H5X24	ø 240 h 50 mm	~ 1850 ml
42H5X26	ø 260 h 50 mm	~ 2170 ml
42H5X28	ø 280 h 50 mm	~ 2540 ml



Round

Cod.	Size	Vol.
1H2X8	ø 80 h 20 mm	~ 100 ml
1H2X10	ø 100 h 20 mm	~ 150 ml
1H2X12	ø 120 h 20 mm	~ 220 ml
1H2X14	ø 140 h 20 mm	~ 300 ml
1H2X16	ø 160 h 20 mm	~ 400 ml
1H2X18	ø 180 h 20 mm	~ 500 ml
1H2X20	ø 200 h 20 mm	~ 630 ml
1H2X22	ø 220 h 20 mm	~ 760 ml
1H2X24	ø 240 h 20 mm	~ 900 ml
1H2X26	ø 260 h 20 mm	~ 1000 ml
1H25X14	ø 140 h 25 mm	~ 385 ml
1H25X16	ø 160 h 25 mm	~ 500 ml
1H25X18	ø 180 h 25 mm	~ 630 ml
1H25X20	ø 200 h 25 mm	~ 780 ml
1H25X22	ø 220 h 25 mm	~ 950 ml
1H25X24	ø 240 h 25 mm	~ 1100 ml
1H35X14	ø 140 h 35 mm	~ 550 ml
1H35X16	ø 160 h 35 mm	~ 700 ml
1H35X18	ø 180 h 35 mm	~ 890 ml
1H35X20	ø 200 h 35 mm	~ 1100 ml
1H35X22	ø 220 h 35 mm	~ 1330 ml
1H35X24	ø 240 h 35 mm	~ 1600 ml
1H4X8	ø 80 h 40 mm	~ 202 ml
1H4X10	ø 100 h 40 mm	~ 310 ml
1H4X12	ø 120 h 40 mm	~ 450 ml
1H4X14	ø 140 h 40 mm	~ 600 ml
1H4X16	ø 160 h 40 mm	~ 800 ml
1H4X18	ø 180 h 40 mm	~ 1000 ml

Cod.	Size	Vol.
1H4X20	ø 200 h 40 mm	~ 1250 ml
1H4X22	ø 220 h 40 mm	~ 1500 ml
1H4X24	ø 240 h 40 mm	~ 1800 ml
1H4X26	ø 260 h 40 mm	~ 2100 ml
1H4X28	ø 280 h 40 mm	~ 2500 ml
1H4X30	ø 300 h 40 mm	~ 2800 ml
1H5X10	ø 100 h 50 mm	~ 393 ml
1H5X12	ø 120 h 50 mm	~ 570 ml
1H5X14	ø 140 h 50 mm	~ 750 ml
1H5X16	ø 160 h 50 mm	~ 1000 ml
1H5X18	ø 180 h 50 mm	~ 1300 ml
1H5X20	ø 200 h 50 mm	~ 1500 ml
1H5X22	ø 220 h 50 mm	~ 1900 ml
1H5X24	ø 240 h 50 mm	~ 2250 ml
1H5X26	ø 260 h 50 mm	~ 2700 ml
1H5X28	ø 280 h 50 mm	~ 3000 ml
1H5X30	ø 300 h 50 mm	~ 3500 ml
1H6X6	ø 60 h 60 mm	~ 170 ml
1H6X8	ø 80 h 60 mm	~ 300 ml
1H6X10	ø 100 h 60 mm	~ 470 ml
1H6X12	ø 120 h 60 mm	~ 680 ml
1H6X14	ø 140 h 60 mm	~ 900 ml
1H6X16	ø 160 h 60 mm	~ 1200 ml
1H6X18	ø 180 h 60 mm	~ 1500 ml
1H6X20	ø 200 h 60 mm	~ 1800 ml
1H6X22	ø 220 h 60 mm	~ 2280 ml
1H6X24	ø 240 h 60 mm	~ 2250 ml
1H6X26	ø 260 h 60 mm	~ 3200 ml
1H6X28	ø 280 h 60 mm	~ 3700 ml



Square

Cod.	Size	Vol.
5H25X14	142 x 142 h 25 mm	~ 500 ml
5H25X16	162 x 162 h 25 mm	~ 650 ml
5H25X18	182 x 182 h 25 mm	~ 830 ml
5H35X14	142 x 142 h 35 mm	~ 700 ml
5H35X16	162 x 162 h 35 mm	~ 910 ml
5H35X18	182 x 182 h 35 mm	~ 1100 ml
5H4X10	102 x 102 h 40 mm	~ 410 ml
5H4X12	122 x 122 h 40 mm	~ 600 ml
5H4X14	142 x 142 h 40 mm	~ 800 ml
5H4X16	162 x 162 h 40 mm	~ 1000 ml
5H4X18	182 x 182 h 40 mm	~ 1300 ml
5H4X20	202 x 202 h 40 mm	~ 1600 ml
5H4X22	222 x 222 h 40 mm	~ 1970 ml
5H4X24	242 x 242 h 40 mm	~ 2350 ml
5H4X26	262 x 262 h 40 mm	~ 650 ml
5H4X28	282 x 282 h 40 mm	~ 3200 ml
5H4X30	302 x 302 h 40 mm	~ 3650 ml
5H5X10	102 x 102 h 50 mm	~ 520 ml
5H5X12	122 x 122 h 50 mm	~ 750 ml
5H5X14	142 x 142 h 50 mm	~ 1000 ml
5H5X16	162 x 162 h 50 mm	~ 1300 ml
5H5X18	182 x 182 h 50 mm	~ 1650 ml
5H5X20	202 x 202 h 50 mm	~ 2000 ml
5H5X22	222 x 222 h 50 mm	~ 2500 ml
5H5X24	242 x 242 h 50 mm	~ 2900 ml
5H5X26	262 x 262 h 50 mm	~ 3380 ml
5H5X28	282 x 282 h 50 mm	~ 4000 ml
5H5X30	302 x 302 h 50 mm	~ 4500 ml
5H6X8	80 x 80 h 60 mm	~ 380 ml
5H6X10	100 x 100 h 60 mm	~ 600 ml
5H6X12	120 x 120 h 60 mm	~ 3750 ml



Rectangular

Cod.	Size	Vol.
11H4L24	243 x 142 h 40 mm	~ 1380 ml
11H4L26	263 x 164 h 40 mm	~ 1700 ml
11H4L28	282 x 183 h 40 mm	~ 2000 ml
11H4L30	302 x 222 h 40 mm	~ 2700 ml
11H4L36	360 x 165 h 40 mm	~ 2400 ml
11H4L38	382 x 262 h 40 mm	~ 4000 ml
11H4L40	403 x 303 h 40 mm	~ 4884 ml
11H4L56	560 x 360 h 40 mm	~ 8064 ml
11H4L59	595 x 395 h 40 mm	~ 9400 ml
11H5L24	243 x 142 h 50 mm	~ 1700 ml
11H5L26	263 x 164 h 50 mm	~ 2100 ml
11H5L28	282 x 183 h 50 mm	~ 2600 ml
11H5L30	302 x 222 h 50 mm	~ 3350 ml
11H5L36	360 x 165 h 50 mm	~ 3000 ml
11H5L38	382 x 262 h 50 mm	~ 5000 ml
11H5L40	403 x 303 h 50 mm	~ 6105 ml
11H5L56	560 x 360 h 50 mm	~ 8300 ml
11H5L59	595 x 395 h 50 mm	~ 11750 ml
RETH4	380 x 580 h 40 mm	~ 8816 ml
RETH5	380 x 580 h 50 mm	~ 11020 ml



Extendable shapes Forme estensibili

Cod.	Min size (mm)	Max size (mm)
RETSPECIAL 1	305 x 305 h 40	570 x 560 h 40
RETSPECIAL 2	305 x 305 h 50	570 x 560 h 50



Number cakes

Nr.	Cod.	Size	Vol.
1	30H4X01	200 x 93 h 40 mm	~ 520 ml
2	30H4X02	200 x 160 h 40 mm	~ 800 ml
3	30H4X03	200 x 160 h 40 mm	~ 740 ml
4	30H4X04	200 x 170 h 40 mm	~ 780 ml
5	30H4X05	200 x 160 h 40 mm	~ 800 ml
6	30H4X06	200 x 160 h 40 mm	~ 870 ml
7	30H4X07	200 x 160 h 40 mm	~ 600 ml
8	30H4X08	200 x 160 h 40 mm	~ 900 ml
9	30H4X09	200 x 160 h 40 mm	~ 870 ml
0	30H4X10	200 x 160 h 40 mm	~ 850 ml

Nr.	Cod.	Size	Vol.
1	40H4X01	300 x 93 h 40 mm	~ 1200 ml
2	40H4X02	300 x 160 h 40 mm	~ 1800 ml
3	40H4X03	300 x 160 h 40 mm	~ 1650 ml
4	40H4X04	300 x 170 h 40 mm	~ 1750 ml
5	40H4X05	300 x 160 h 40 mm	~ 1800 ml
6	40H4X06	300 x 160 h 40 mm	~ 1950 ml
7	40H4X07	300 x 160 h 40 mm	~ 1350 ml
8	40H4X08	300 x 160 h 40 mm	~ 2000 ml
9	40H4X09	300 x 160 h 40 mm	~ 1950 ml
0	40H4X10	300 x 160 h 40 mm	~ 1900 ml

SPECIAL FOR CHRISTMAS



Pandoro mould/stampo Pandoro

Aluminium 10/10 moulds.
Stampi in alluminio 10/10.

Cod.	Size	Vol.
30SP0100	ø 108 h 80 mm	~ 100 gr

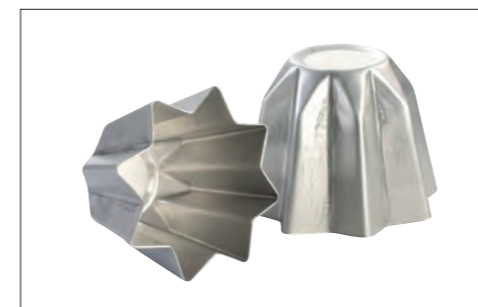

Cod.	Size	Vol.
30SP0250	ø 165 h 130 mm	~ 250 gr
30SP0500	ø 195 h 145 mm	~ 500 gr
30SP0750	ø 205 h 155 mm	~ 750 gr
30SP1000	ø 230 h 170 mm	~ 1000 gr

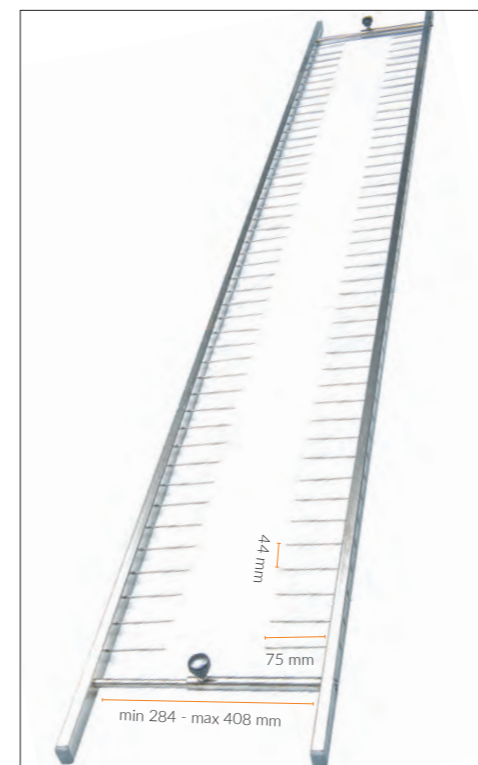

Panettoni turning rod Asse gira Panettoni

Made of stainless steel, easy to stack on both trolleys and wall racks, it is a perfect anchor for all types of moulds (panettone-colombs-stars-cakes-trees etc.). The handle firm and safe has a stainless steel ring nut that allows optimal closure of the axis.

Overall size: 221 cm. Usable space: 202 cm.
Width: min 284 - max 408 mm. Fixed needles ø 2,7 mm.
In acciaio inox, di facile impilamento sia su carrelli che su rastrelliere murali, è un perfetto ancoraggio per tutti i tipi di stampi (panettoni-colombe-stelle-cake-alberi etc.). L'impugnatura salda e sicura presenta una ghiera in acciaio inox che permette una chiusura ottimale dell'asse. Ingombro totale: 221 cm. Spazio utilizzabile: 202 cm. Aghi fissi ø 2,7 mm.

50GIRA02

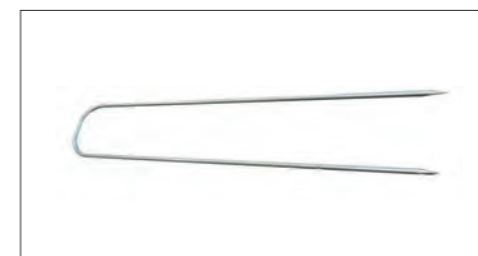

Panettone turning needles Aghi gira Panettoni

Cod.	Total size	Tip length Lunghezza puntale	Pack
53GP01	600 mm ø 2 mm	8 mm	10 pcs

CANNOLI MOULDS/STAMPI PER CANNOLI



Metal.
Metallo.

Cod.	Size	Pack
50CI12X20	12 x 200 mm	12 pcs
50CI16X20	16 x 200 mm	12 pcs
50CI22X14	22 x 140 mm	10 pcs



St. steel.
Acciaio inox.

Cod.	Size	Pack
50CO30X12	∅ 30 x 120 mm	12 pcs
50CO35X14	∅ 35 x 140 mm	12 pcs
50CO40X16	∅ 40 x 160 mm	12 pcs



Baking plastic.
Plastica da cottura.

Cod.	Size	Pack
CANNOLO	∅ 30 x 120 mm	10 pcs

CUTTER WITH HANDLE/TAGLIAPASTA CON MANICO

St. steel/Acciaio inox.



Round/Tondo

Cod.	Type	Size	Pc
CUT1LM12	smooth/liscio	∅ 120 h 20 mm	1
CUT1FM12	wavy/ondulato	∅ 120 h 20 mm	1

CUTTERS KIT/KIT TAGLIAPASTA

St. steel/Acciaio inox.

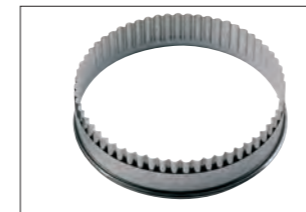

Round/Tondi

Cod.	Type	Size	Pcs
CUT1L7	smooth/lisci	30 - 40 - 50 - 60 - 70 - 80 - 90 mm	7
CUT1L9	smooth/lisci	30 - 40 - 50 - 60 - 70 - 80 - 90 - 100 - 110 mm	9
CUT1L12	smooth/lisci	30 - 40 - 50 - 60 - 70 - 80 - 90 - 100 - 110 - 120 - 130 - 140 mm	12
CUT1L16	smooth/lisci	20 - 30 - 40 - 50 - 60 - 70 - 75 - 80 - 85 - 90 - 95 - 100 - 110 - 120 - 125 - 140 mm	16
CUT1F9	wavy/ondulati	30 - 40 - 50 - 60 - 70 - 80 - 90 - 100 - 110 mm	9
CUT1F12	wavy/ondulati	30 - 40 - 50 - 60 - 70 - 80 - 90 - 100 - 110 - 120 - 130 - 140 mm	12

Hearts/Cuori

Cod.	Type	Size	Pcs
CUT7L7	smooth/lisci	35 - 40 - 45 - 55 - 65 - 75 - 85 mm	7
CUT7L9	smooth/lisci	36 - 43 - 52 - 60 - 70 - 80 - 90 - 100 - 110 mm	9
CUT7L12	smooth/lisci	36 - 43 - 52 - 60 - 70 - 80 - 90 - 100 - 110 - 120 - 130 - 140 mm	12
CUT7F9	wavy/ondulati	60 - 70 - 80 - 90 - 100 - 110 - 120 - 130 - 140 mm	9

CUTTERS KIT/KIT TAGLIAPASTA

Stainless steel/Acciaio inox.

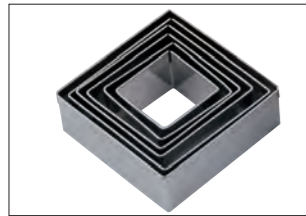

Cod.	Size	Pcs
CUT5L7	65 - 57 - 50 - 45 - 40 - 35 - 27 mm	7



Cod.	Size	Pcs
CUT6L7	90 x 60 - 80 x 50 - 70 x 45 - 60 x 40 - 50 x 30 - 40 x 25 - 30 x 20 mm	7

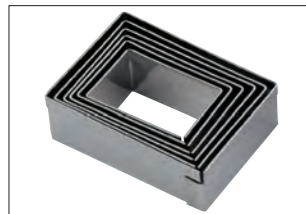

Cod.	Size	Pcs
CUT22L7	65 x 50 - 60 x 45 - 55 x 40 - 50 x 35 - 47 x 32 - 43 x 28 - 37 x 25 mm	7



Cod.	Size	Pcs
CUT3L7	75 - 67 - 63 - 57 - 52 - 47 - 42 mm	7



Cod.	Size	Pcs
CUT28L7	100 x 50 - 90 x 45 - 85 x 43 - 75 x 40 - 70 x 35 - 60 x 30 - 55 x 25 mm	7



Cod.	Size	Pcs
CUT8L7	90 x 60 - 80 x 50 - 70 x 45 - 65 x 40 - 55 x 33 - 45 x 25 - 35 x 20 mm	7

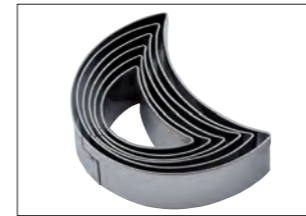

Cod.	Size	Pcs
CUT15L7	86 x 45 - 76 x 38 - 68 x 33 - 61 x 30 - 55 x 25 - 49 x 21 - 42 x 17 mm	7



Cod.	Size	Pcs
CUT18L7	90 x 65 - 80 x 60 - 70 x 50 - 55 x 40 - 45 x 30 - 33 x 23 - 25 x 18 mm	7



Cod.	Size	Pcs
CUT12L7	90 - 80 - 65 - 53 - 42 - 55 - 30 mm	7



Cod.	Size	Pcs
CUT26L7	90 - 80 - 70 - 55 - 40 - 35 - 30 mm	7



Cod.	Size	Pcs
CUT31L7	90 - 80 - 70 - 60 - 50 - 40 - 30 mm	7



Cod.	Size	Pcs
CUT10L9	37 - 51 - 66 - 82 - 96 - 110 - 125 - 137 - 150 mm	9

ICE-CREAM

ICE-CREAM MOULDS





Classic

Kit composed of: 2 moulds 390 x 146 mm
+ 50 wooden sticks + tray 390 x 292 mm.
*Kit composto da: 2 stampi 390 x 146 mm
+ 50 bastoncini in legno + vassoio 390 x 292 mm.*

Ice-cream size	Weight	Prod.	Material
44 x 22 h 93 mm	~ 78 ml	12 pcs	Silicone

104000



Classic mini

Kit composed of: 2 moulds 390 x 118 mm
+ 50 wooden sticks + tray 410 x 255 mm.
*Kit composto da: 2 stampi 390 x 118 mm
+ 50 bastoncini in legno + vassoio 410 x 255 mm.*

Ice-cream size	Weight	Prod.	Material
33 x 18 h 69 mm	~ 35 ml	16 pcs	Silicone

104001





Brick

Kit composed of: 2 moulds 390 x 146 mm
+ 50 wooden sticks + tray 390 x 292 mm.
*Kit composto da: 2 stampi 390 x 146 mm
+ 50 bastoncini in legno + vassoio 390 x 292 mm.*

Ice-cream size	Weight	Prod.	Material
35 x 25 h 93 mm	~ 74 ml	12 pcs	Silicone

104002



Brick mini

Kit composed of: 2 moulds 390 x 118 mm
+ 50 wooden sticks + tray 410 x 255 mm.
*Kit composto da: 2 stampi 390 x 118 mm
+ 50 bastoncini in legno + vassoio 410 x 255 mm.*

Ice-cream size	Weight	Prod.	Material
26,5 x 21 h 70 mm	~ 35 ml	16 pcs	Silicone

104003



Classic and Brick displays Espositori per Classic e Brick

Cod.	Size	Pack
10E007	375 x 235 h 45 mm	1 pc

Classic mini and Brick mini displays Espositori per Classic mini e Brick mini

Cod.	Size	Pack
10E006	370 x 235 h 35 mm	1 pc



Wooden sticks for Classic and Brick Bastoncini in legno per Classic e Brick

Cod.	Size	Pack
10SL114	114 h 9,5 mm	500 pcs

Wooden sticks for Classic mini and Brick mini Bastoncini in legno per Classic mini e Brick mini

Cod.	Size	Pack
10SL072	72 h 8 mm	500 pcs



Ice Tube

Reusable and dishwasher-safe mould for up to 50 washes. 100% recyclable, BPA free.
Stampo riutilizzabile e lavabile in lavastoviglie fino a 50 lavaggi. 100% riciclabile, BPA free.

Ice-cream size	Weight	Pack
ø 53 h 174 mm	~ 150 ml	100 pcs

CLP01



White plastic holder for blast chiller
Supporto in plastica bianca per abbattitore

290 x 390 h 120 mm
 28 seats/sedi

CLPESPOB

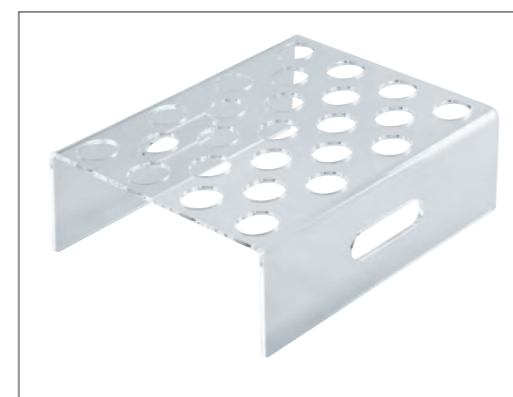

Transparent display for vertical showcase
Espositore trasparente per vetrina verticale

280 x 360 h 120 mm
 25 seats/sedi

CLPESPOBTRA



Transparent display for horizontal showcase
Espositore trasparente per vetrina orizzontale

250 x 360 h 45 mm
 21 seats/sedi

CLPESPO21

GHIACCIOLO FLEX

Wooden sticks not included.
Bastoncini in legno non inclusi.



Wave

Ice-cream size	Weight	Prod.	Material
49 x 22 h 125 mm	~ 86 ml	24 pcs	thermo-plastic

105000



Recouvert

Ice-cream size	Weight	Prod.	Material
56 x 33 h 102 mm	~ 90 ml	24 pcs	thermo-plastic

105002

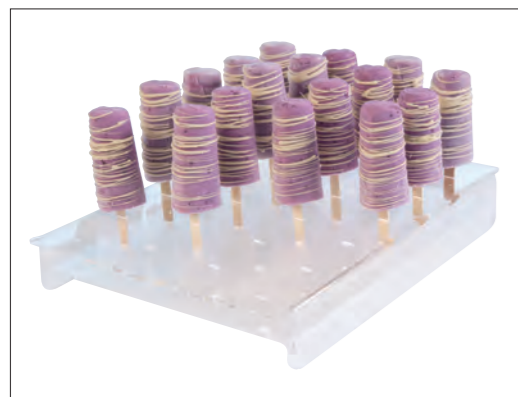

Ghiacciolo Flex display for horizontal showcase
Espositore Ghiacciolo Flex per vetrina orizzontale

360 x 250 h 50 mm
24 seats/sedi

10-E002

PUSH UP POPS



Push Up Pops

Reusable and dishwasher-safe mould.
Stampo riutilizzabile e lavabile in lavastoviglie.

Ice-cream size	Weight	Pack.	Material
ø 40 h 188 mm	~ 90 ml	100 pcs	plastic

GST01



Mini Push Up Pops

Reusable and dishwasher-safe mould.
Stampo riutilizzabile e lavabile in lavastoviglie.

Ice-cream size	Weight	Pack.	Material
ø 35 h 196 mm	~ 50 ml	100 pcs	plastic

GST10



Push Up Pops display for blast chiller
Espositore Push Up Pops per abbattitore

310 x 400 h 90 mm
28 seats/sedi

GSTESPOB

SHOP ACCESSORIES





Deep MeltinChoc

MADE IN ITALY

A dry melter designed for ice-cream parlours: thanks to its shape and size, it is ideal for covering ice-creams and parfaits on sticks with chocolate. It is presented in a classic colouring, reminiscent of chocolate tones, to adapt to any type of furniture and to be used directly on the counter. Its technical features, including the thermostat that allows you to regulate the precise temperature and the removable basin in anodized aluminium for easier cleaning, make Deep MeltinChoc an essential item.

Scioglitore a secco pensato per le gelaterie: grazie alla sua forma e dimensione è ideale per le coperture in cioccolato di gelati e semifreddi su stecco. Viene presentato con colorazione classica, che ricorda i toni del cioccolato, per adattarsi ad ogni tipologia di arredo e per essere utilizzato direttamente sul banco. Le sue caratteristiche tecniche, tra cui il termostato che consente di regolare precisamente temperatura e la vasca estraibile in alluminio anodizzato per una più facile pulizia, fanno di Deep MeltinChoc un articolo essenziale.



Deep MeltinChoc

Chocolate melter
Scioglitore per cioccolato

ø 20,5 h 21 cm

Basin size/misura vaschetta: ø 14 h 18 cm - cap. 1,7 lt

MC10

Wirings available upon request/cablaggi disponibili su richiesta:
UK / US / JAPAN / AUSTRALIA / CHINA.



Spare part basin
Vaschetta di ricambio

ø 14 h 18 cm - cap. 1,7 lt

MC001001

SPATULAS/SPATOLE



Ice-cream spatulas Spatole gelato

Total length/misura totale: 26 cm

Cod.	Spoon Cucchiaino	Handle Manico	Colour
10SG00	10 x 5,8 cm	13 cm	Transparent Trasparente
10SG01	10 x 5,8 cm	13 cm	White Bianco
10SG07	10 x 5,8 cm	13 cm	Black Nero



Carapine spatulas Spatole per carapina

Total length/misura totale: 20 cm

Cod.	Spoon Cucchiaino	Handle Manico	Colour
10SGC00	10 x 5,8 cm	10 cm	Transparent Trasparente
10SGC01	10 x 5,8 cm	10 cm	White Bianco
10SGC07	10 x 5,8 cm	10 cm	Black Nero

SCOOPS/PORZIONATORI



Ice-cream scoops Porzionatori gelato

Cod.	Size	Cap.
10PG01	ø 3,8 x 20 cm	1/65 l
10PG02	ø 4,4 x 20 cm	1/40 l
10PG03	ø 4,8 x 22 cm	1/30 l
10PG04	ø 5 x 22,5 cm	1/24 l
10PG05	ø 5,7 x 23 cm	1/20 l



Ice-cream spoons plus **New** Cucchiai gelato plus

Handle with self-defrost liquid.
Manico con liquido di scongelamento.

Cod.	Spoon	Cap.
10CG30	3,2 x 4,8 cm	30 gr
10CG42	3,5 x 5,1 cm	42 gr
10CG60	3,8 x 5,7 cm	60 gr
10CG70	4,5 x 6 cm	70 gr

TASTE MARKERS / SEGNAGUSTO

Immersion



Plexiglass taste markers
Segnagusto in plexiglass

Cod.	Size	Pack	Colour
10SI001B	150 x 70 mm	10 pcs	Opaline Opalino
10SI002B	180 x 84 mm	10 pcs	Opaline Opalino



Taste marker holders
Supporti per segnagusto

Cod.	Size	Pack	Colour
10SEG	89 x 102 h 190 mm	10 pcs	Transparent Trasparente



Writable taste markers
Cartellini segnagusto scrivibili

Cod.	Size	Pack	Colour
10SEG05	89 x 102 mm	30 pcs	White Bianco

Free standing



Plexiglass taste markers
Segnagusto in plexiglass

Cod.	Size	Pack	Colour
10SA001B	85 h 50,5 mm	10 pcs	Opaline Opalino
10SA001N	85 h 50,5 mm	10 pcs	Black Nero



Plastic name tag holder
Porta cartellino in plastica

Cod.	Size	Pack	Colour
10SEGB	87 x 52 mm	10 pcs	Transparent Trasparente



Writable taste markers
Cartellini segnagusto scrivibili

Cod.	Size	Pack	Colour
10SEG06	87 x 50 mm	30 pcs	White Bianco

PLEXIGLASS CONES HOLDER/PORTACONI IN PLEXIGLASS



Counter cone holder - 4 seats
Reggi coni da banco - 4 sedi

14 x 14 h 24 cm - holes/fori: \varnothing 3 cm

Cod.	Colour
AG00206N	satin/satinato
AG00208N	Black/Nero



Counter cone holder - 3 seats
Reggi coni da banco - 3 sedi

24,5 x 8,5 h 13 cm
holes/fori: \varnothing 3,5 cm

AG03108



Counter cone holder - 3 seats
Reggi coni da banco - 3 sedi

25 x 7,5 h 13 cm
holes/fori: \varnothing 3,5 cm

AG03000



Counter cone holder - 4 seats
Reggi coni da banco - 4 sedi

28,5 x 9 h 13 cm
holes/fori: \varnothing 3,5 cm

AG03306



New

Upside-down cone box with removable interior and lid
Box porta coni rovesci, con interno e coperchio
removibili

25 x 24,5 h 25,5 cm

AG01500



Cones holder with removable divider
Porta coni con divisorio estraibile

43 x 40 h 43 cm

AG04610



Cones holder with lid
Porta coni con coperchio

30 x 37 h 32 cm

AG03650



Three tubular cone holder with lids.
Porta coni a tre vani tubolari con coperchi

36 x 32,5 h 39 cm

AG03640



Cones holder with pull-out drawer, without door
Porta coni con cassetto estraibile, senza porta

25,5 x 18 h 60,5 cm
 upper hole/foro superiore: ø 3,5 cm
 lower hole/foro inferiore: ø 2 cm

AG00930



Cones holder - 12 seats
Porta coni - 12 sedi

33 x 25 h 50 cm
 holes/fori: ø 3,5 cm

Cod.	Colour
AG00906P	satin/satinato
AG00908P	Black/Nero



Swivel cone holder - 18 seats
Porta coni girevole - 18 sedi

ø 32 h 60 cm
 holes/fori: ø 3,5 cm

Cod.	Colour
AG00706P	satin/satinato
AG00708P	Black/Nero

PLEXIGLASS ACCESSORIES/ACCESSORI IN PLEXIGLASS



Cup holder with paddle compartment and pocket for tags
Porta coppette con vano porta palette e tasca per cartellini

28 x 25 h 55 cm

AG05301



Paddle holder
Porta palette

17 x 26 h 16 cm

AG01801



Paddle holder
Porta palette

22 x 26 h 21 cm

AG00606

PLEXIGLASS CONTAINERS/CONTENITORI IN PLEXIGLASS



Container with rotating half-lid
Contenitore con mezzo coperchio ruotabile

Cod.	Size
AG03720	∅ 20 h 20 cm
AG03730	∅ 20 h 30 cm



Multipurpose container
Contenitore multiuso

Cod.	Size
AG01710	12,5 x 18 h 20,5 cm
AG01720	17,5 x 27 h 31 cm



Multipurpose container
Contenitore multiuso

Cod.	Size
AG01410	25 x 18,5 h 20 cm
AG01420	30 x 18,5 h 30 cm
AG01430	35 x 18,5 h 40 cm



New

Single compartment grain container
Contenitore porta granelle a singolo scomparto

Cod.	Size
BOX0801	8 x 8 h 8 cm
BOX1201	12 x 12 h 12 cm
BOX1601	16 x 16 h 16 cm



New

Two compartment grain container
Contenitore porta granelle a doppio scomparto

Cod.	Size
BOX1602	16 x 8 h 8 cm
BOX2402	24 x 12 h 12 cm
BOX3202	32 x 16 h 16 cm



New

Three compartment grain container
Contenitore porta granelle a triplo scomparto

Cod.	Size
BOX2403	24 x 12 h 12 cm
BOX3603	36 x 12 h 12 cm
BOX4803	48 x 16 h 16 cm



Plexiglass jars with glazed lid
Barattoli in plexiglass con coperchio satinato

Cod.	Size
BA1008	ø 10 h 8 cm
BA1015	ø 10 h 15 cm
BA1020	ø 10 h 20 cm
BA1208	ø 12 h 8 cm
BA1215	ø 12 h 15 cm
BA1220	ø 12 h 20 cm
BA1508	ø 15 h 8 cm
BA1515	ø 15 h 15 cm
BA1520	ø 15 h 20 cm
BA1808	ø 18 h 8 cm

Cod.	Size
BA1815	ø 18 h 15 cm
BA1820	ø 18 h 20 cm
BA1825	ø 18 h 25 cm
BA1830	ø 18 h 30 cm
BA2008	ø 20 h 8 cm
BA2015	ø 20 h 15 cm
BA2020	ø 20 h 20 cm
BA2025	ø 20 h 25 cm
BA2030	ø 20 h 30 cm



Plexiglass two-tier praline display case
with removable trays
Vetrina porta praline in plexiglass a due piani
con vassoi removibili

New

7,5 x 35 h 10 cm

VB00150

MACHINERY

CHOCOLATE MELTERS & FOUNTAINS



DigitalMeltinchoc
MADE IN ITALY

DIGITAL MELTER

Among all models, the digital melter is the newest and most advanced one. Thanks to its technology, it enables rapid melting and allows you to keep a constant and homogeneous temperature. Graphic display, immersion thermal probe, sound indicators and digital control of the three preset programs, based on the type of chocolate, also allow less experienced to work with chocolate. On request melters with GB / USA / JAPAN / AUSTRALIA / CHINA wiring are available.

Tra tutti i modelli, lo scioglitore digitale è il più nuovo ed evoluto. Grazie alla tecnologia utilizzata consente un rapido scioglimento e il mantenimento della temperatura costante e omogenea. Display grafico, sonda termica a immersione, indicatori sonori e controllo digitale dei tre programmi pre-impostati, in base al tipo di cioccolato da usare, consentono anche ai meno esperti di lavorare con il cioccolato. Su richiesta disponibili scioglitori con cablaggio GB / USA / GIAPPONE / AUSTRALIA / CINA.

Watch
the video



Digital Meltinchoc

Cod.	Size	Basin/vasca	Cap.
MCD101	24 x 40 x 13,5 cm	18 x 32,5 h 10 cm	3,6 l
MCD102	33 x 40 x 13,5 cm	26,5 x 32 h 10 cm	6 l
MCD103	39,5 x 45 x 13,5 cm	32 x 35,3 h 10 cm	9 l
MCD104	39,5 x 62 x 13,5 cm	32,5 x 53 h 10 cm	13,7 l

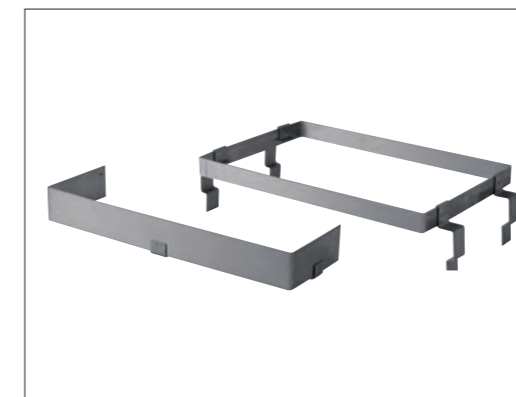

Mould support

St. steel mould support and spatula cleaner. Suitable for MCD103 and MCD104. Kit supporto stampo e pulisci spatola in acciaio inox. Adatto per MCD103 and MCD104.

MCDA103

Meltinchoc

MADE IN ITALY

ANALOGIC MELTER

The Meltinchoc analogical chocolate melter has a removable stainless steel tank and plastic body. The manual thermostat allows you to adjust and maintain the chocolate at the desired temperature.

Precision, design, simplicity and small size are the main advantages of this counter-top device that can satisfy even the most demanding confectioners.

On request available melters with GB / USA / JAPAN / AUSTRALIA / CHINA wiring.

Lo scioglitore analogico Meltinchoc è dotato di vasca in acciaio inox rimovibile, con scocca in plastica. Il termostato manuale permette di regolare e mantenere il cioccolato alla temperatura desiderata. Precisione, design, semplicità e ingombro ridotto sono i principali vantaggi di questo dispositivo da banco in grado di soddisfare anche i pasticceri più esigenti.

Su richiesta disponibili scioglitori con cablaggio GB / USA / GIAPPONE / AUSTRALIA / CINA.



Meltinchoc mono

Cod.	Size	Basin/vasca	Cap.
MC105	26 x 26 x 13,5 cm	14 x 15,5 h 10 cm	1,5 l
MC101	24 x 40 x 13,5 cm	18 x 32 h 10 cm	3,6 l
MC102	33 x 40 x 13,5 cm	26,5 x 32 h 10 cm	6 l
MC103	39,5 x 45 x 13,5 cm	32 x 35,3 h 10 cm	9 l
MC104	39,5 x 62 x 13,5 cm	32,5 x 53 h 10 cm	13,7 l



Meltinchoc multi 0,8 l

Single basin size/Misura singola vasca: 18,3 x 15 h 10 cm

Cod.	Size	Basins/vasche	Cap.
MC107	39,5 x 26,5 x 13,5 cm	3 x 0,8 l	2,4 l



Meltinchoc multi 1,5 l

Single basin size/Misura singola vasca: 14 x 15,5 h 10 cm

Cod.	Size	Basins/vasche	Cap.
MC108	42 x 26 x 13,5 cm	2 x 1,5 lt	3 l
MC100	61 x 26 x 13,5 cm	3 x 1,5 l	4,5 l
MC106	79 x 26 x 13,5 cm	4 x 1,5 l	6 l

MiniMeltinchoc
MADE IN ITALY

MINI ANALOGIC MELTER

The mini dry chocolate melter Mini Meltinchoc is suitable both in laboratories for small productions of pralines and subjects, and in ice-cream shops for covering ice-creams and desserts on sticks. The contained capacity allows the processing of small quantities of chocolate without waste and the practical extractable tank guarantees an easy and quick maintenance. The refined design and the small dimensions make it perfect to be used also directly on the counter, for the benefit of customers. With manual thermostat. On request available melters with GB / USA / JAPAN / AUSTRALIA/ CHINA wiring.

Il mini scioglitore a secco per cioccolato Mini Meltinchoc è adatto sia in laboratorio per piccole produzioni di praline e soggetti, sia in gelateria per la copertura di gelati e dessert su stecco. La capacità contenuta consente la lavorazione di piccole quantità di cioccolato senza sprechi e la pratica vasca estraibile garantisce una manutenzione facile e veloce. Il design raffinato e le dimensioni ridotte lo rendono perfetto per l'utilizzo anche direttamente sul bancone, a favore dei clienti. Con termostato manuale.

Su richiesta disponibili scioglitori con cablaggio GB / USA / GIAPPONE/ AUSTRALIA / CINA.



Mini Meltinchoc

Cod.	Size	Colour	Cap.
MC09G	26 x 26 h 16 cm	Gray/Grigio	1,8 l
MC09N	26 x 26 h 16 cm	Black/Nero	1,8 l
MC09R	26 x 26 h 16 cm	Red/Rosso	1,8 l



Basin

Spare part basin
Vaschetta di ricambio

Cod.	Size	Cap.
MC000305	ø 18,5 h 10,7 cm	1,8 l

CHOCOLATE FOUNTAINS/FONTANE PER CIOCCOLATO



Chocobig Evolution

Versatile, easy to use and sure to impress. The temperature control knob allows extended use and the automatic switch-off prevents overheating. Totally made in Italy, it has silent operation, stainless steel structure and auger and removable bowl to make emptying and cleaning very easy.
Versatile, di facile utilizzo e di sicuro effetto. La manopola per la regolazione della temperatura consente utilizzi prolungati e lo spegnimento automatico ne evita il surriscaldamento. Interamente made in Italy, ha funzionamento silenzioso, struttura e coclea in acciaio inox e vasca smontabile per rendere svuotamento e pulizia molto facili.

ø 380 h 800 mm
 Cap. 3,5 - 8 kg
 230V - 50Hz - 1,6A - 370W

CHOCOBIGEV



Chocolate Fountain

Compact and light, the smallest of our professional fountains is suitable to melt and keep about a litre of chocolate at the desired temperature in the most informal occasions or in small spaces. It keeps chocolate at a temperature of 36/39°C. Stainless steel structure, plastic auger and adjustable feet.
Compatta e leggera, la più piccola delle nostre fontane professionali è adatta a sciogliere e mantenere circa un litro di cioccolato alla temperatura desiderata nelle occasioni più informali o con spazi contenuti. Mantiene il cioccolato alla temperatura di 36/39°C. Struttura in acciaio inox, coclea in resistente plastica e piedini regolabili.

ø 210 h 390 mm
 Cap. 1 lt
 220/240V - 50Hz - 0,77A - 170W

CHOCOFONT



SPECIAL MACHINERY



EASYSHERE BALL SHAPING MACHINE

3500 spheres in 26 minutes

EasySphere is the revolutionary tool that allows you to produce perfectly shaped pastry spheres while cutting labour costs to a minimum.

The innovative system makes it possible to produce spheres with different dough types, reducing production time by more than 50% compared to the manual method, with results that are nothing short of excellent. Thanks to the internal roller, it is possible to cut the dough very easily and shape perfectly shaped balls. EasySphere can be used by any operator while maintaining the standard of processing and size. Precision, ease, speed: with EasySphere you will improve the way you work.

EasySphere è lo strumento rivoluzionario che permette di produrre sfere di pasta perfette, abbattendo al massimo i costi di manodopera.

Il sistema innovativo consente di realizzare sfere, con impasti di diverso tipo, riducendo di più del 50% i tempi di produzione rispetto al metodo manuale, con risultati a dir poco eccellenti. Grazie al rullo interno è possibile tagliare l'impasto con estrema facilità e modellare sfere dalla forma perfetta. EasySphere può essere usato da qualsiasi operatore mantenendo lo standard di lavorazione e pezzatura. Precisione, facilità, velocità: con EasySphere migliorerai il tuo modo di lavorare.



Watch
the video



HOW IT WORKS/COME FUNZIONA

How to use
& recipes

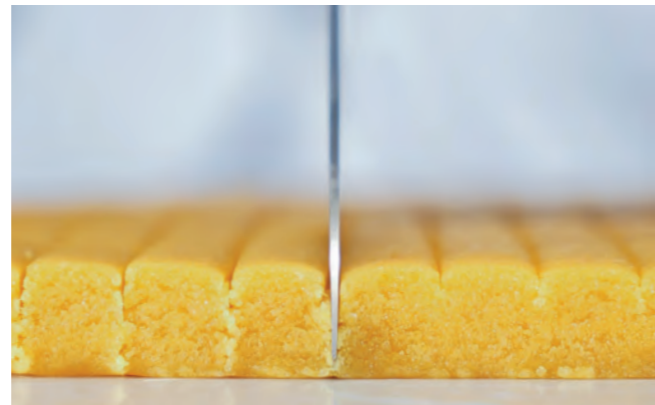

Incise the dough with the help of the cutting template and cut it with a knife to make strips.
Incidi la pasta aiutandoti con la dima di taglio e tagliala con il coltello per realizzare le listarelle.



Create cylinders by shaping the strips and place them on the plexiglass serving tray.
Crea dei cilindri modellando le listarelle e posizionali sul vassoio di servizio in plexiglass.

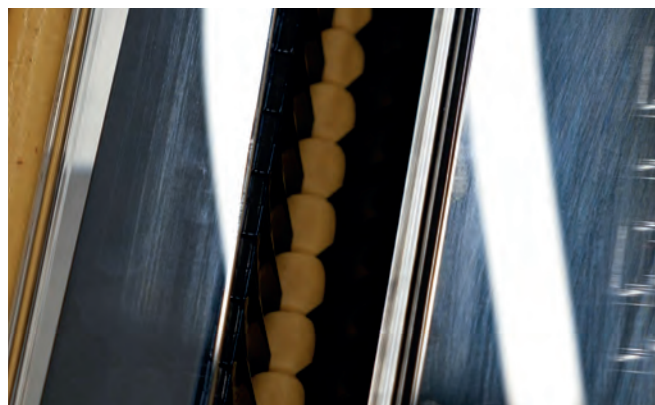

Insert the dough cylinder into the rail and turn the knob.
Inserisci il cilindro di pasta nella sede e gira la manopola.

- 50% PRODUCTION TIME

- 50% TEMPO DI PRODUZIONE

+ 150% PRODUCTION EFFICIENCY

+ 150% EFFICIENZA PRODUTTIVA

- 20% LABOUR COSTS

- 20% COSTI DI MANODOPERA



EasySphere

Removable plexiglass tray and brush for cleaning the inner roller included. *Vassoio estraibile in plexiglass e scovolino per la pulizia del rullo interno inclusi.*

Cod.	Overall size Misura ingombro	Spheres Sfere
50ES01	58,5 x 42 x 37 cm	ø 20 mm
50ES02	58,5 x 42 x 37 cm	ø 24 mm

Complementary accessories: extensible dough cutter ROTAPINOX 5 P, plastic cutting grid 50GD0015 for 50ES01 or 50GD0018 for 50ES02. See pages 400-402.

Accessori complementari: tagliapasta estensibile ROTAPINOX 5 P, dima di taglio 50GD0015 per 50ES01 o 50GD0018 per 50ES02. Vedi pag. 400-402.

LEVEL
BISCUIT & MORE

DOUGH SPREADER

Level is designed to rationalise production: it speeds up times, simplifies steps and reduces costs with perfect layering.

Level: handy and practical wheel-mounted dough spreader that allows you to quickly create precise and regular layers, even in the thinnest thicknesses. It facilitates and speeds up the uniform spreading of biscuit, sponge cakes, chocolate and similar products, sliding on different surfaces, such as baking paper and silicone mats. Made entirely in stainless steel, it has millimetric graduated scale, adjustment knobs and a movable wall for thickness control. It has directional wheels for fast sliding and internal divides for flow adjustment.

Level è progettata per razionalizzare la produzione: velocizza i tempi, semplifica i passaggi e riduce i costi con una stratificazione perfetta.

Level: stendi impasto su ruote maneggevole e pratico che permette di creare rapidamente strati precisi ed uniformi, anche negli spessori più sottili. Facilita e velocizza la stesura uniforme di biscuit, pan di spagna, cioccolato e prodotti simili, scorrendo su diverse superfici, come carta forno o tappeti in silicone. Completamente in acciaio inox, con scala graduata millimetrica, manopole di regolazione e parete mobile per il controllo dello spessore. Ha ruote direzionali per lo scorrimento veloce e divisori interni per regolare il flusso di impasto.

Designed in
collaboration with



Watch
the video



HOW IT WORKS/COME FUNZIONA



Choose the spreading thickness on the graduated scale, using the plexiglass rulers. Set the output flow according to the density of the compound, choosing the opening size of the bottom.

Scegli lo spessore di stesura sulla scala graduata, aiutandoti con i regoli in plexiglass. Imposta il flusso d'uscita in base alla densità del composto, scegliendo la misura di apertura del fondo.



Making sure that the guillotine is closed, pour the mixture into the steel bowl, using a spatula.

Accertandoti che la ghigliottina sia chiusa, versa il composto dentro la vasca, aiutandoti con una spatola.



Raise the guillotine and by sliding the wheels easily pull the instrument onto the chosen support, paper, silicone or acetate.

Alza la ghigliottina e facendo scorrere le ruote tira facilmente lo strumento sul supporto scelto, carta, silicone o acetato.

PRECISE & EASY SETTING

REGOLAZIONE FACILE & PRECISA

SUITABLE FOR DIFFERENT MIXTURES

ADATTA A COMPOSTI DIVERSI

REGULAR PRODUCTION

PRODUZIONE SEMPRE REGOLARE



Level

Accessory kit for precise adjustment of thin layers included. *Kit accessori per la regolazione precisa degli spessori sottili incluso.*

Cod.	Overall size Misura ingombro	Cap.	Weight Peso
50LE001	48 x 20 h 20 cm	12 lt	4,3 kg

MART CUTTER

AUTOMATIC RIBBON CUTTER

Electric ribbon cutter ideal for automatically cutting reels of acetate tape to the desired length, in the required amount.

It makes easier to optimise and manage the stock of different sizes of acetate tape, producing the required quantity of each length avoiding cutting errors and loss of time. Automatic or manual mode can be set, by selecting on the digital display, the required length or previously preset length, and the desired quantity of strips. On the display, in addition to the chosen settings, the progress of the job will be visible. The unique reel holder ensures that the cutting of the different strip widths is always centred. The practical plexiglass tray collects the cut strips and folds them up after use to protect the machine. Electrical voltage: 100V, 120V, 220-240V (other power cords on request).

Taglianastri elettrico ideale per tagliare automaticamente le bobine di nastro acetato della lunghezza desiderata, nella quantità necessaria.

Consente di ottimizzare e gestire con maggiore semplicità lo stock delle diverse misure di nastro acetato, producendo la quantità necessaria di ciascuna lunghezza evitando errori di taglio e perdita di tempo. Si possono impostare la modalità automatica o manuale, selezionando sul display digitale, la lunghezza richiesta o quella precedentemente preimpostata, e la quantità di strisce desiderate. Sul display oltre alle impostazioni scelte, sarà visibile lo stato di avanzamento del lavoro. L'esclusivo supporto per le bobine garantisce sempre la centratura del taglio delle diverse larghezze di nastro. Il pratico vassoio in plexiglass raccoglie le strisce tagliate e richiuso dopo l'uso, serve da protezione della macchina.

Tensione elettrica: 100V, 120V, 220-240V (altri cavi di alimentazione su richiesta).

Watch
the video

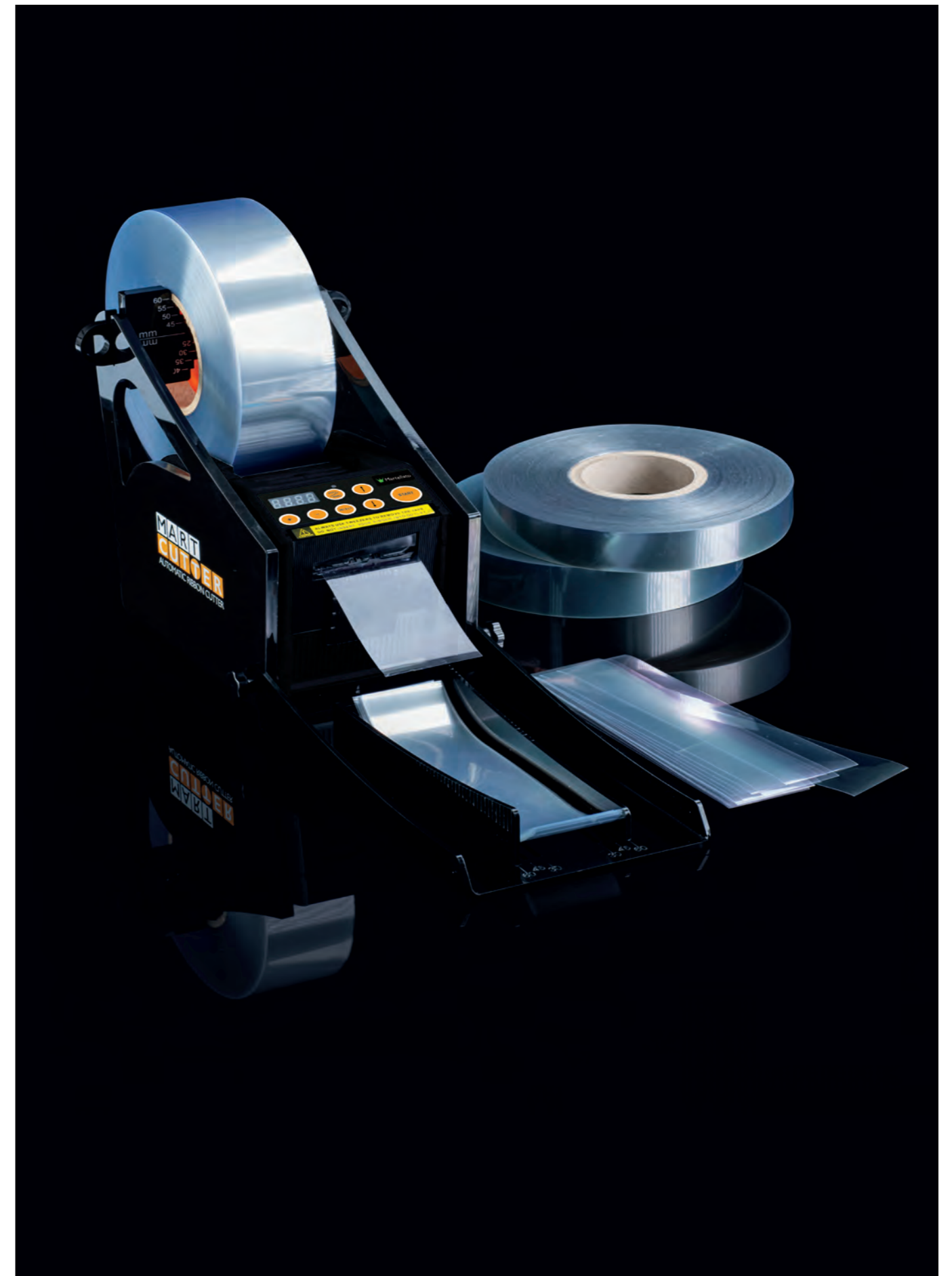

HOW IT WORKS/COME FUNZIONA

Suitable for rolls with core \varnothing 76 mm, max width 60 mm, max length \varnothing 210 mm.

Acetate thickness: 80/150 μ m.

Adatta per bobine con anima \varnothing 76 mm, larghezza max 60 mm, lunghezza max \varnothing 210 mm.

Spessore acetato: 80/150 μ m.



After opening the transport assembly, insert the reel of acetate ribbon into the holder and place the latter in the body of the tape cutter.

Dopo aver aperto il blocco di trascinamento, inserisci la bobina di nastro acetato nel supporto e posiziona quest'ultimo nella scocca del taglianastri.



Slide one end of the tape into the feed roller until it comes out of the front slot. Then close the transport assembly and press Start to activate the MartCutter.

Fai scivolare un'estremità del nastro nel rullo di alimentazione fino a farlo uscire dalla feritoia frontale. Poi chiudi il blocco di trascinamento e premi Start per attivare la MartCutter.



Press Select to select one of the 6 preset cutting lengths. You can change the cutting lengths using the +/- keys. Press Select again to reset the desired number of strips, from 1 to 999. Press Start to start cutting.

Premi Select per selezionare una delle 6 lunghezze di taglio preimpostate. Puoi modificare le lunghezze di taglio usando i tasti +/- . Premi nuovamente Select per reimpostare il numero di strisce desiderate, da 1 a 999. Premi Start per far partire il taglio.

FOLDING TRAY

VASSOIO SALVASPAZIO

SUITABLE FOR ROLLS OF DIFFERENT WIDTHS

ADATTO PER BOBINE CON DIVERSE LARGHEZZE

DIGITAL DISPLAY

DISPLAY DIGITALE



MartCutter

Compatible with all acetate tapes by Martellato. See pag. 250.
Compatibile con tutti i nastri acetati Martellato. Vedi pagina 250.

Cod.	Overall size Misura ingombro	Power Potenza	Weight Peso
50MC001	min 250 x 175 h 290 mm max 483 x 175 h 290 mm	25 W	2,9 kg

SPINNER

E-Turning Cake

ELECTRIC TURNING CAKE

The electric turning cake: compact, practical and light, that simplifies and helps your work.

Spinner is composed by a stable base with circular guide and planar plexiglass plate, with graduated scale for the correct and constant positioning of the product and the measurement of the decoration. The regulator allow you to vary speed and direction of rotation, by choosing between clockwise and anti-clockwise. LEDs indicate rotation direction and their brightness indicates the speed. The practical non-slip silicone mat ensures greater stability during processing.

Il giratorta elettrico: compatto, pratico e leggero, che semplifica e aiuta il tuo lavoro.

Spinner è composto da un corpo stabile con trascinatore circolare sul quale ruota un piano in plexiglass perfettamente planare in plexiglass, con scala graduata in cm ed inch, che consente il corretto e costante posizionamento del prodotto e la misurazione del decoro.

Con il regolatore puoi variare la velocità e il senso di rotazione, scegliendo tra orario e antiorario. I led direzionali indicano il senso di rotazione e la loro intensità ne indica la velocità. Il pratico tappetino in silicone antiscivolo garantisce maggiore stabilità durante la lavorazione.



Watch
the video



Spinner

Cod.	Overall size Misura ingombro	Weight peso
SPINNER	27 x 26 h 12 cm	1,6 kg

GUITAR

CUTTER *by* MARTELLATO

Aluminium guitar that makes it possible to produce precise products, simplify production and increase productivity: an essential partner in every workshop.

Its structure is designed to increase the cutting angle by giving greater mechanical strength to reduce the practitioner's effort. The wider and longer base allows greater stability during cutting. The different cutting frame sizes allow various combinations to create mignons, single portions as well as cutting cremini, ganaches, short pastry and puff pastry, all soft masses and raw materials. You will have an optimisation of production, raising standards, efficiency and reducing waste thanks to the sizes specifically designed to fit those of trolleys, refrigerators and others already present in the laboratory.

Chitarra in alluminio che permette di realizzare prodotti precisi, semplificare la produzione e aumentare la produttività: il partner indispensabile in ogni laboratorio.

La sua struttura è studiata per aumentare l'angolo di taglio conferendo maggiore forza meccanica per ridurre lo sforzo del professionista. La base più ampia ed allungata consente maggiore stabilità durante il taglio. Le diverse misure di taglio dei telai, facilmente intercambiabili, consentono varie combinazioni per creare mignon, monoporzioni oltre a tagliare cremini, ganache, pasta frolla e sfoglia, tutte le masse morbide, le materie prime. Si avrà un'ottimizzazione della produzione, elevando gli standard, l'efficienza e riducendo gli sprechi grazie alle misure appositamente studiate per adattarsi a quelle di carrelli, frigoriferi ed altro già presenti in laboratorio.



Watch
the video





Single Guitar with 3 frames Chitarra singola con 3 telai

The kit includes a 600 x 400 mm base with 3 frames (one 22,5 mm, one 30 mm and one 45 mm), a raplette, a stainless steel plate and the service kit.

Il kit include la base 600 x 400 mm e 3 telai (1 da 22,5 mm, 1 da 30 mm e 1 da 45 mm), una raplette, un piatto in acciaio inox e il kit assistenza.

Cod.	Cutting surface Piano di taglio	Overall size Misura ingombro
50CS200	380 x 400 mm	636 x 442 h 109 mm

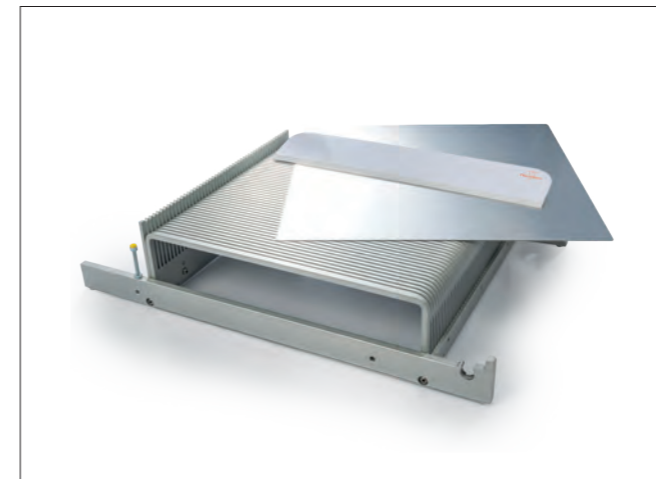

Guitar base Base Chitarra

Cod.	Cutting surface Piano di taglio	Overall size Misura ingombro
50CSBA	380 x 400 mm	600 x 400 h 100 mm



Frames Telai

Cod.	Cutting size Misura di taglio	Overall size Misura ingombro
50CSTE15	15 mm	61,5 x 43 x 9 cm
50CSTE22	22,5 mm	61,5 x 43 x 9 cm
50CSTE30	30 mm	61,5 x 43 x 9 cm
50CSTE37	37 mm	61,5 x 43 x 9 cm
50CSTE45	45 mm	61,5 x 43 x 9 cm

EASY Guitar CUTTER

The guitar is the ideal tool for cutting cremini, ganache, jellies, mignons and soft masses precisely.

The cutting base is made of strong plastic material, the frames are made of stainless steel and the wires are individually interchangeable. The guitar consists of a solid base and frames of different sizes, which are supplied separately according to the needs of the individual operator, as well as being predisposed for cutting and calibrating large quantities of products precisely and without imperfections.

Mini Guitar, ideal for restaurants, ice-cream and chocolate shops, is suitable for small productions of confectionery products. Thanks to its small size it can be easily stored even in small spaces and used when necessary.

In every model package includes a stainless steel plate, a plastic spatula, 3 spare wires and 2 keys for fixing wires.

La chitarra è lo strumento ideale per tagliare in modo preciso cremini, ganache, gelatine, mignon e masse morbide.

La base di taglio è realizzata in resistente materiale plastico, i telai sono in acciaio inox e i fili intercambiabili singolarmente.

La chitarra è composta da una solida base e da telai di diverse misure, forniti separatamente in base alle esigenze del singolo operatore, oltre ad essere predisposta per il taglio e il calibro di grandi quantità di prodotti in modo preciso e privo di imperfezioni.

La Mini Chitarra, ideale per ristoranti, gelaterie e cioccolaterie, è adatta a piccole produzioni di prodotti dolciari. Grazie alle dimensioni contenute può essere facilmente riposta anche in piccoli spazi e utilizzata all'occorrenza.

In tutti i modelli la confezione include un piatto in acciaio inox, una racla PST, 3 fili di ricambio e 2 chiavi per fissare i fili.

GUITARS/CHITARRE



Double Guitar base Base Chitarra doppia

Aluminium base frame and polyethylene base. Frames not included.

Telaio base in alluminio e base in polietilene. Telai non inclusi.

Cod.	Cutting surface Piano di taglio	Overall size Misura ingombro
50-CD100N	360 x 350 mm	500 x 480 h 150 mm



Single Guitar base Base Chitarra singola

Polyethylene base. Frames not included.
Base in polietilene. Telai non inclusi.

Cod.	Cutting surface Piano di taglio	Overall size Misura ingombro
50-CS100	420 x 360 mm	530 x 450 h 160 mm



Frames/Telai

Cod.	Cutting size Misura di taglio	Overall size Misura ingombro
50-C015	15 mm	61,5 x 43 x 7 cm
50-C022	22 mm	61,5 x 43 x 7 cm
50-C030	30 mm	61,5 x 43 x 7 cm
50-C045	45 mm	61,5 x 43 x 7 cm

50-C015 is only for frontal cutting, others for both frontal and side cutting.

50-C015 è solo per taglio frontale, gli altri per taglio frontale e laterale.

Spare parts on next page./Ricambi a pagina seguente.

MINI GUITARS/MINI CHITARRE



Kit Mini double Guitar Kit Mini Chitarra doppia

Polyethylene base 2 frames included.
Base in polietilene. 2 telai inclusi.

Cod.	Cutting surface Piano di taglio	Frames Telai
CHITMINID22	240 x 250 cm	2 x 22 mm
CHITMINID30	240 x 250 cm	2 x 30 mm



Mini single Guitar base Base per Mini Chitarra singola

Polyethylene base. Frames not included.
Base in polietilene. Telai non inclusi.

Cod.	Cutting surface Piano di taglio
CHITBA24	250 x 280 mm



Mini double guitar base Base per Mini Chitarra doppia

Polyethylene base. Frames not included.
Base in polietilene. Telai non inclusi.

Cod.	Cutting surface Piano di taglio
CHITBAD24	240 x 250 cm



Frames/Telai

Cod.	Cutting size Misura di taglio	Overall size Misura ingombro
CHIT15	15 mm	443 x 314 h 87 mm
CHIT22	22,5 mm	443 x 314 h 87 mm
CHIT30	30 mm	443 x 314 h 87 mm

CHIT15 is only for frontal cutting, others for both frontal and side cutting.
CHIT15 è solo per taglio frontale, gli altri per taglio frontale e laterale.



Kit Mini single Guitar Kit Mini Chitarra singola

Polyethylene base. 1 frame included.
Base in polietilene. 1 telaio incluso.

Cod.	Cutting surface Piano di taglio	Frames Tela
CHITMINI15	250 x 280 mm	15 mm
CHITMINI	250 x 280 mm	22 mm
CHITMINI30	250 x 280 mm	30 mm

SPARE PARTS/RICAMBI

Cod.		Guitar	Mini Guitar
CHITRIC 8	special spanner/chiavi di fissaggio	✓	✓
CHITRIC 10	bolts and nuts/viti e dadi	✓	✓
CHITRIC 9A	st. steel wire/filo inox 0,7	✓	
CHITRIC 9	st. steel wire/filo inox 0,6		✓
CHITRIC 6/D	st. steel plate/piatto inox	✓	
CHITP	st. steel plate/piatto inox		✓
50SPB43	plastic spatula/spatola in plastica	✓	
50SPB30	plastic spatula/spatola in plastica		✓

HERO Driving Force GUITAR CUTTER

Ideal for cutting cremini and ganache with dried fruit or hard products and small pastries even at low temperature

The advancement of the work table is done manually, through a handwheel operated by the user, who can control its speed. The short wire guarantees greater mechanical resistance and therefore allows even the hardest or frozen dough to be cut into precise portions. Easy to clean, it does not require any maintenance.

Package includes: a stainless steel plate, a plastic spatula and 2 keys for fixing wires.

Ideale per tagliare cremini e ganache con frutta secca o prodotti duri e piccola pasticceria anche a bassa temperatura.

L'avanzamento del piano di lavoro avviene manualmente, attraverso un volantino azionato dall'operatore, che può controllarne la velocità. Il filo corto garantisce una maggiore resistenza meccanica e consente quindi di tagliare in porzioni precise anche gli impasti più duri o congelati. Facile da pulire, non richiede alcuna manutenzione.

Inclusi nella confezione: un piatto in acciaio inox, una racla PST e 2 chiavi per fissare i fili.

Watch
the video

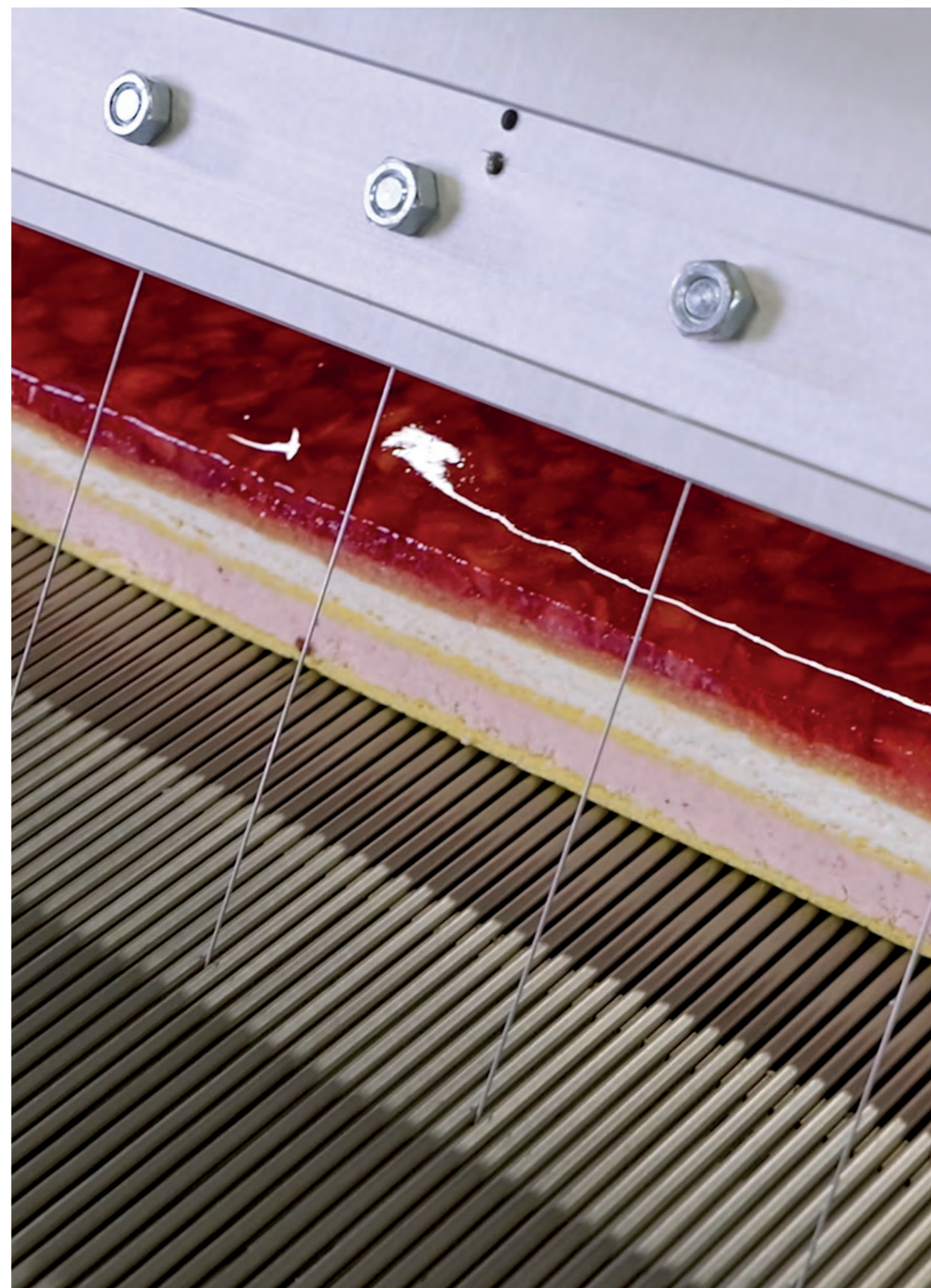

DRIVING FORCE GUITARS/CHITARRE A SPINTA



Driving force guitar Chitarra a spinta

Frames not included.
Telai non inclusi.

Cod.	Cutting surface Piano di taglio	Overall size Misura ingombro
CSM040	40 x 40 cm	min: 58 x 83 h 30 cm max: 53 x 1260 h 30 cm
CSM060	60 x 60 mm	min: 73 x 103 h 30 cm max: 73 x 163 h 30 cm

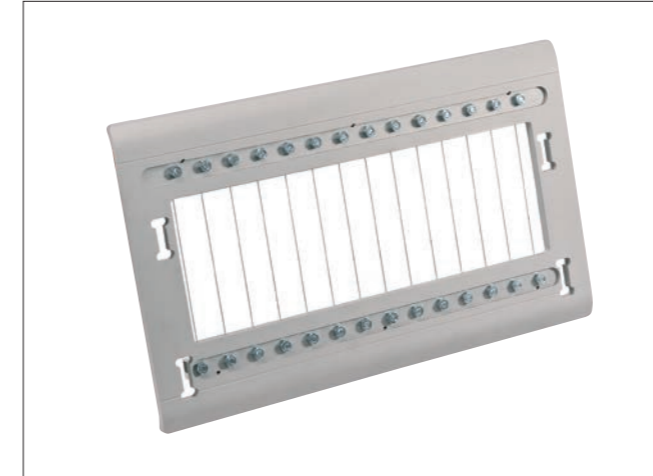

Frames for CSM060 Telai per CSM060

Cod.	Cutting size Misura di taglio	Overall size Misura ingombro
CSM06001	10 mm	75 x 31 h 4,5 cm
CSM06002	15 mm	75 x 31 h 4,5 cm
CSM06003	20 mm	75 x 31 h 4,5 cm
CSM06004	25 mm	75 x 31 h 4,5 cm
CSM06005	30 mm	75 x 31 h 4,5 cm
CSM06006	35 mm	75 x 31 h 4,5 cm
CSM06007	40 mm	75 x 31 h 4,5 cm
CSM06008	50 mm	75 x 31 h 4,5 cm
CSM06009	60 mm	75 x 31 h 4,5 cm



Frames for CSM040 Telai per CSM040

Cod.	Cutting size Misura di taglio	Overall size Misura ingombro
CSM04001	10 mm	54 x 31 h 4,5 cm
CSM04002	15 mm	54 x 31 h 4,5 cm
CSM04003	20 mm	54 x 31 h 4,5 cm
CSM04004	25 mm	54 x 31 h 4,5 cm
CSM04005	30 mm	54 x 31 h 4,5 cm
CSM04006	35 mm	54 x 31 h 4,5 cm
CSM04007	40 mm	54 x 31 h 4,5 cm
CSM04008	50 mm	54 x 31 h 4,5 cm
CSM04009	60 mm	54 x 31 h 4,5 cm

SPARE PARTS/RICAMBI

Cod.		CSM040	CSM060
CHITRIC 8	special spanner/chiavi di fissaggio	√	√
CHITRIC 9	st. steel wire/filo inox 0,6	√	√
CHITRIC 10	bolts and nuts/viti e dadi	√	√
CSM0402	st. steel plate/piatto inox	√	
CSM0602	st. steel plate/piatto inox		√
CSMSPB40	plastic spatula/spatola in plastica	√	
CSMSPB60	plastic spatula/spatola in plastica		√

ROLLING MACHINE

Professional dough rolling machine with Teflon roller, designed and built to solve the problems of forming disks for the preparation of pizza, bread, focaccia, pies, etc. It does not alter the characteristics of the dough by cold working, allowing also the processing of sugar. It also has a transparent plexiglass roller guard for maximum safety without altering visibility and a knob for adjusting the thickness from 1 to 4 mm.

Macchinario stendi pasta professionale con rullo in teflon, ideato e realizzato per risolvere i problemi di formatura dei dischi per la preparazione di pizze, pane, focacce, tortine, ecc. Lavora a freddo e non altera le caratteristiche della pasta, permettendo anche la lavorazione dello zucchero.

Presenta inoltre un proteggi rullo in plexiglass trasparente per la massima sicurezza senza alterare la visibilità e una manopola per regolare lo spessore da 1 a 4 mm.



Rolling machine Stendi pasta

0,25kw Single-phase motor/motore monofase
230W - 1ph - 50Hz
Spreading thicknesses/spessori di stesura:
1 - 2 - 3 - 4 mm

Cod.	Overall size Misura ingombro	Roller length Lunghezza rullo
40-W200	45 x 35,5 h 37,5 cm	31 cm
40-W20045	65 x 35,5 h 37,5 cm	50 cm

WARMING PLATE

Electric warming plate with metal structure and a tempered glass top suitable for food contact, ideal for working with chocolate. Perfect for heating and keeping food warm.

It has a thermostat for temperature regulation and non-slip pads to guarantee stability. Thanks to the compact design and low weight, it is easy to carry and clean with a soft damp cloth. On request available melters with GB / USA / AUSTRALIA wiring.

Piano elettrico riscaldante con struttura in metallo e piano in vetro temperato idoneo al contatto alimentare, ideale nella lavorazione del cioccolato. È inoltre perfetto per riscaldare e mantenere caldi i cibi. Provvisto di termostato per la regolazione della temperatura e piedini antiscivolo per garantire stabilità.

Facile da trasportare, grazie al design compatto e al peso ridotto, si pulisce agevolmente con un panno morbido e umido.

Su richiesta disponibile con cablaggio GB / USA / AUSTRALIA.

Watch
the video



Warming plate Piano riscaldante

Temp. 30°C - 85°C
260W

Cod.	Overall size Misura ingombro	Weight Peso
50PR002	64 x 45,5 h 7,5 cm	2,5 kg

EQUIPMENT

PASTRY BAGS & PIPING TIPS



TheMART
Poche

PASTRY BAGS MADE IN MARTELLATO

Speed, precision, non-slip grip and high resistance make our pastry bags a valuable ally for both pastry chefs and confectioners.

A single weld, thinner for convenience and stronger to prevent breakage during use, together with the high-quality multilayer material, guarantee the durability of the pastry bags for a long time.

Velocità, precisione, presa antiscivolo e alta resistenza fanno delle nostre sac à poche un prezioso alleato di pasticceri e chef. Un'unica saldatura, più sottile per consentire maggiore praticità e più resistente per evitarne la rottura durante l'uso, insieme al materiale multistrato di alta qualità, garantiscono la durata delle sac à poche per molto tempo.



EASY TO USE

FACILITÀ DI UTILIZZO

HIGH QUALITY

ALTA QUALITÀ

SINGLE SEAL

SALDATURA SINGOLA

MULTIUSE

MULTIUSO



Green Poche

Disposable sac à poche in green multilayer polyethylene, with non-slip surface on the outside and smooth inside to allow the product to come out easily.

Sac à poche monouso in polietilene multistrato verde, con superficie antiscivolo all'esterno e liscio all'interno per consentire al prodotto di uscire facilmente.

Cod.	Size	Package	Pack
50-1030	h 30 cm	box	100 pcs
50-1040	h 40 cm	box	100 pcs
50-1055	h 55 cm	box	100 pcs
50-1065	h 65 cm	box	100 pcs
50103020STD	h 30 cm	roll	20 pcs
50104020STD	h 40 cm	roll	20 pcs
50105520STD	h 55 cm	roll	20 pcs



Blue Poche - extra comfort

Disposable sac à poche in multilayer polyethylene with exclusive non-slip treatment on the outside, which gives a pleasant sensation to the touch and greater flexibility.

Sac à poche monouso in polietilene multistrato con esclusivo trattamento antiscivolo all'esterno, che conferisce una piacevole sensazione al tatto e una maggiore flessibilità.

Cod.	Size	Package	Pack
50-2030	h 30 cm	box	100 pcs
50-2040	h 40 cm	box	100 pcs
50-2055	h 55 cm	box	100 pcs
50-2065	h 65 cm	box	100 pcs

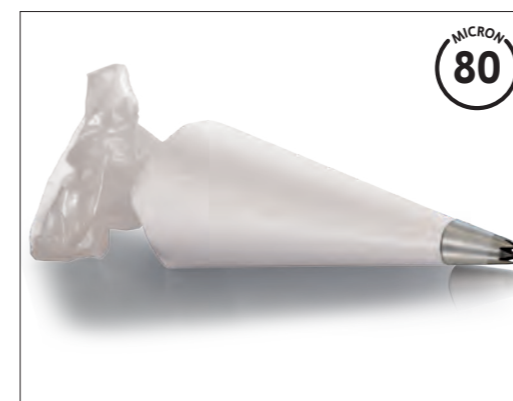

Crystal Poche

Disposable sac à poche made of extra strong transparent polyethylene, and can be filled several times.

Sac à poche monouso in polietilene trasparente extra forte, riempibili numerose volte.

Cod.	Size	Package	Pack
ROLL H 30	h 30 cm	box	100 pcs
ROLL H 40	h 40 cm	box	100 pcs
ROLL H 55	h 55 cm	box	100 pcs
ROLL H 65	h 65 cm	box	100 pcs
ROLLH3020STD	h 30 cm	roll	20 pcs
ROLLH4020STD	h 40 cm	roll	20 pcs
ROLLH5520STD	h 55 cm	roll	20 pcs



Pastry bag support Vaso porta sac à poche

ø 200 h 240 mm

50VA001A

Pastry bag display Espositore sac à poche

Cod.	Size	Cap.
ESPOP30	190 x 250 h 210 mm	18 pcs
ESPOP40	250 x 250 h 230 mm	18 pcs
ESPOP55	310 x 250 h 260 mm	18 pcs



REUSABLE PASTRY BAGS



Superflex

Reusable pastry bag with smooth inner surface, to facilitate product release, and a rough external surface, to give a better grip. A special sealing system and the high tensile strength of the bag guarantee hygiene and long-lasting life. Resistant up to 100°C, do not absorb dirt. Microwave and dishwasher safe.

Sac à poche riutilizzabile con superficie interna liscia, per facilitare il rilascio del prodotto, e superficie esterna ruvida, per una migliore presa. Uno speciale sistema di chiusura e l'elevata resistenza alla trazione del sacchetto garantiscono igiene e durata nel tempo. Resistenti fino a 100°C, non assorbono lo sporco. Adatti al microonde e alla lavastoviglie.



Cod.	Size	Pack	w/packaging
SPR034	34 cm	1 pc	no
SPR034/C	34 cm	1 pc	yes
SPR045	45 cm	1 pc	no
SPR045/C	45 cm	1 pc	yes
SPR050	50 cm	1 pc	no
SPR050/C	50 cm	1 pc	yes

Cotton

Reusable pastry bags, produced with natural cotton fibres coated with polyurethane to give greater resistance to pressure, with reinforced buttonhole and tip. Ideal for harder mixtures.

Sac à poche riutilizzabili, prodotti con fibre naturali di cotone rivestito di poliuretano per dare maggiore resistenza alla pressione, con asola e punta rinforzata. Ideali per impasti più duri.



Cod.	Size	Pack
STD 034 CM	34 cm	1 pc
STD 040 CM	40 cm	1 pc
STD 046 CM	46 cm	1 pc
STD 050 CM	50 cm	1 pc
STD 055 CM	55 cm	1 pc
STD 060 CM	60 cm	1 pc
STD 065 CM	65 cm	1 pc
STD 070 CM	70 cm	1 pc
STD 075 CM	75 cm	1 pc

Flex

Reusable pastry bags, made of polyester fibres and coated with polyurethane, with buttonhole.

Sac à poche riutilizzabili, prodotti con fibre di poliestere e rivestite di poliuretano, con asola.



Cod.	Size	Pack
FLEX 034 CM	34 cm	1 pc
FLEX 040 CM	40 cm	1 pc
FLEX 046 CM	46 cm	1 pc
FLEX 050 CM	50 cm	1 pc
FLEX 055 CM	55 cm	1 pc
FLEX 060 CM	60 cm	1 pc
FLEX 065 CM	65 cm	1 pc
FLEX 070 CM	70 cm	1 pc

PIPING TIPS/BOCCHETTE

Round/Tonda



Cod.	Tip (mm)	Size (mm)	Pack
BT 202	ø 2	ø 25 h 50	5 pcs
BT 203	ø 3	ø 25 h 49	5 pcs
BT 204	ø 4	ø 25 h 49	5 pcs
BT 205	ø 5	ø 25 h 47	5 pcs
BT 206	ø 6	ø 25 h 46	5 pcs
BT 207	ø 7	ø 25 h 47	5 pcs
BT 208	ø 8	ø 25 h 44	5 pcs
BT 209	ø 9	ø 25 h 42	5 pcs
BT 210	ø 10	ø 31 h 49	5 pcs
BT 211	ø 11	ø 31 h 47	5 pcs
BT 212	ø 12	ø 31 h 47	5 pcs
BT 213	ø 13	ø 31 h 48	5 pcs
BT 214	ø 14	ø 31 h 48	5 pcs
BT 215	ø 15	ø 36 h 52	5 pcs
BT 216	ø 16	ø 36 h 50	5 pcs
BT 217	ø 17	ø 36 h 48	5 pcs
BT 218	ø 18	ø 36 h 49	5 pcs
BT 220	ø 20	ø 36 h 45	5 pcs
BT 222	ø 22	ø 36 h 44	5 pcs
BT 224	ø 24	ø 36 h 43	5 pcs

Cod.	Tip (mm)	Pack
BS 10 T	ø 4 - 5 - 6 - 7 - 8 - 9 - 10 - 12 - 13 - 15	10 pcs

Open star/Stella aperta



Cod.	Tip (mm)	Size (mm)	Pack
BS 102	ø 2	ø 25 h 49	5 pcs
BS 103	ø 3	ø 25 h 50	5 pcs
BS 104	ø 4	ø 25 h 47	5 pcs
BS 105	ø 5	ø 25 h 49	5 pcs
BS 106	ø 6	ø 25 h 48	5 pcs
BS 107	ø 7	ø 25 h 47	5 pcs
BS 108	ø 8	ø 25 h 46	5 pcs
BS 109	ø 9	ø 25 h 44	5 pcs
BS 110	ø 10	ø 31 h 53	5 pcs
BS 111	ø 11	ø 31 h 50	5 pcs
BS 112	ø 12	ø 31 h 49	5 pcs
BS 113	ø 13	ø 31 h 49	5 pcs
BS 114	ø 14	ø 36 h 53	5 pcs
BS 115	ø 15	ø 36 h 52	5 pcs
BS 116	ø 16	ø 36 h 53	5 pcs
BS 117	ø 17	ø 36 h 52	5 pcs
BS 118	ø 18	ø 36 h 49	5 pcs

Cod.	Tip (mm)	Pack
BS 10 S	ø 4 - 5 - 6 - 7 - 8 - 9 - 10 - 12 - 13 - 15	10 pcs

French star/Stella francese



Cod.	Tip (mm)	Size (mm)	Pack
BF 0867	ø 16	ø 36 h 52	5 pcs
BF 0869	ø 20	ø 36 h 48	5 pcs
BF 310	ø 4	ø 25 h 47	5 pcs
BF 311	ø 6	ø 25 h 47	5 pcs
BF 312	ø 7	ø 25 h 46	5 pcs
BF 313	ø 9	ø 25 h 44	5 pcs
BF 314	ø 10	ø 31 h 49	5 pcs
BF 314/11	ø 11	ø 31 h 48	5 pcs
BF 315	ø 4	ø 31 h 48	5 pcs
BF 316	ø 13	ø 31 h 48	5 pcs
BF 317	ø 15	ø 36 h 53	5 pcs
BF 318	ø 16	ø 36 h 52	5 pcs
BF 319	ø 18	ø 36 h 48	5 pcs

Closed star/Stella chiusa



Cod.	Tip (mm)	Size (mm)	Pack
BC 320	ø 2	ø 25 h 47	5 pcs
BC 321	ø 3	ø 25 h 48	5 pcs
BC 322	ø 4	ø 25 h 47	5 pcs
BC 323	ø 5	ø 25 h 46	5 pcs
BC 324	ø 6	ø 25 h 44	5 pcs
BC 325	ø 7	ø 31 h 48	5 pcs
BC 326	ø 8	ø 31 h 48	5 pcs
BC 327	ø 9	ø 31 h 48	5 pcs
BC 328	ø 10	ø 36 h 52	5 pcs
BC 329	ø 11	ø 36 h 51	5 pcs
BC 330	ø 12	ø 36 h 47	5 pcs

Stripes and borders/Linee e bordi (pack 5 pcs)



Cod.	Tip	Size (mm)	Cod.	Tip	Size (mm)	Cod.	Tip	Size (mm)
BX 1510	ø 13 L 25	ø 31 h 46,3	BX 1303	16	ø 25 h 40	BX 1217	18 x 4	ø 25 h 40,7



Cod.	Tip	Size (mm)	Cod.	Tip	Size (mm)	Cod.	Tip	Size (mm)
BX 1405	20 x 7	ø 25 h 40	BX0043	10	ø 18 h 28	BX 0134	15 x 2	ø 25 h 43

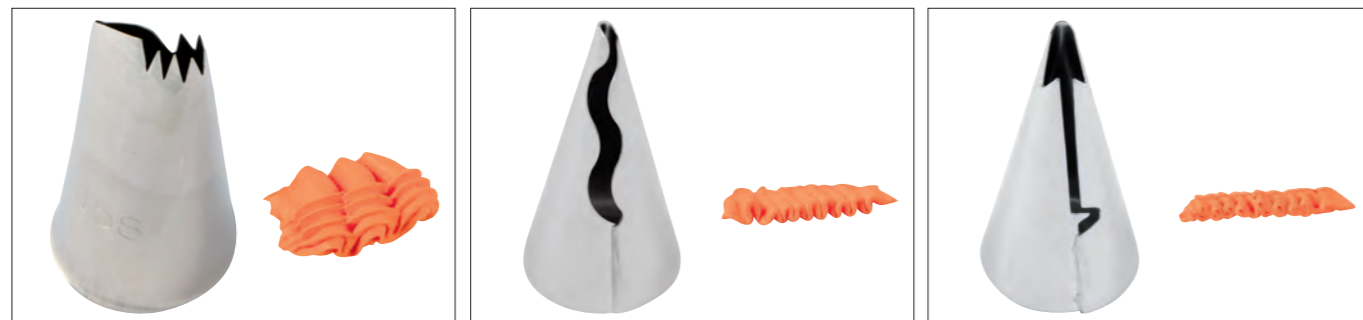

Cod.	Tip	Size (mm)	Cod.	Tip	Size (mm)	Cod.	Tip	Size (mm)
BX 0158	15 x 5	ø 25 h 43,5	BX0026	25	ø 18 h 36	BX0027	25	ø 18 h 36



Cod.	Tip	Size (mm)	Cod.	Tip	Size (mm)	Cod.	Tip	Size (mm)
BX 9017	17	ø 31 h 56,5	BD 300	16 x 2	ø 25 h 39,5	BX 2312	ø 13 L 20	ø 25 h 39,3
BX 9022	20	ø 31 h 44,2	BD 301	20 x 3	ø 31 h 46			
			BD 302	27	ø 36 h 48			



Cod.	Tip	Size (mm)	Cod.	Tip	Size (mm)
BX 8019	9	ø 18 h 31,5	BX0049	ø 7	ø 18 h 30

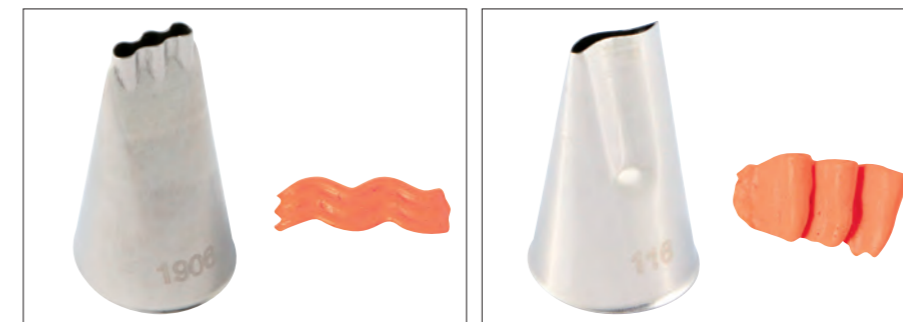

Cod.	Tip	Size (mm)	Cod.	Tip	Size (mm)
BX 1906	12 x 3	ø 25 h 43	BX 0116	16 x 2	ø 25 h 42
			BX 0119	19 x 2	ø 25 h 43

St. Honorè (pack 5 pcs)



Cod.	Tip	Size (mm)
BX9990	ø 10	ø 30 h 50
BX9991	ø 12	ø 30 h 50
BX9992	ø 14	ø 30 h 50

Flowers/Floreali (pack 5 pcs)



Cod.	Tip	Size (mm)	Cod.	Tip	Size (mm)	Cod.	Tip	Size (mm)
BX 0190	ø 3	ø 25 h 43,5	BX 6018	ø 6	ø 31 h 44,3	BX 5017	ø 15	ø 31 h 42,6



Cod.	Tip	Size (mm)	Cod.	Tip	Size (mm)	Cod.	Tip	Size (mm)
BC 0855	ø 20	ø 31 h 47	BX 0510	ø 5	ø 25 h 40,5	BX 7020	ø 10	ø 31 h 46



Cod.	Tip	Size (mm)	Cod.	Tip	Size (mm)	Cod.	Tip	Size (mm)
BR 330	ø 15	ø 31 h 48	BA 411	ø 15	ø 31 h 50	BS 0D6K	ø 10	ø 25 h 43
BR 331	ø 18	ø 31 h 46	BA 413	ø 17	ø 31 h 47,5	BS 0F6K	ø 18	ø 31 h 47
BR 332	ø 20	ø 36 h 51	BA 415	ø 20	ø 36 h 50			



Cod.	Tip	Size (mm)	Cod.	Tip	Size (mm)	Cod.	Tip	Size (mm)
BX 0108	13	ø 25 h 41,5	BX 1013	13	ø 25 h 39	BS 0195	ø 12	ø 25 h 41,7
			BS 0195K	ø 14	ø 25 h 37,5			



Cod.	Tip	Size (mm)	Cod.	Tip	Size (mm)	Cod.	Tip	Size (mm)
BX 4014	ø 5	ø 25 h 43	BX 2013	ø 8	ø 25 h 41	BX 0123	ø 17	ø 25 h 40,5

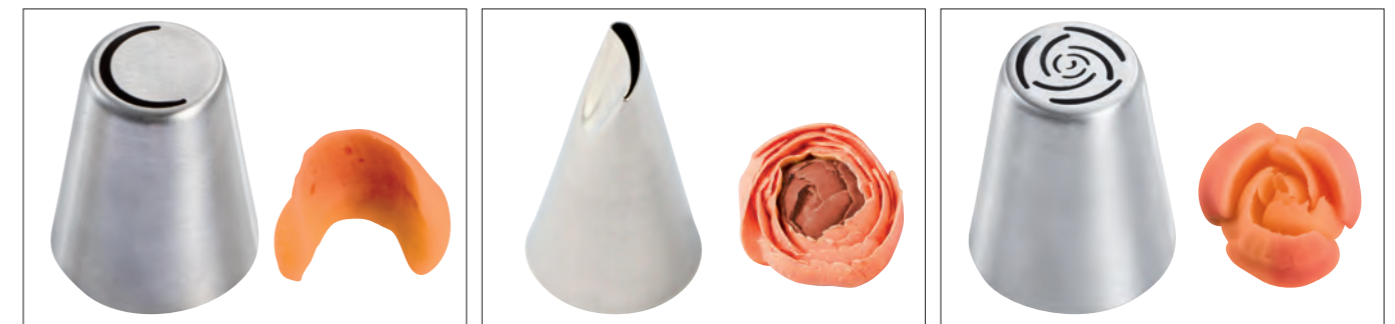

Cod.	Tip	Size (mm)	Cod.	Tip	Size (mm)	Cod.	Tip	Size (mm)
BX0014		ø 37 h 42	BX 0120	13 x 2	ø 25 h 44	BX0017		ø 37 h 42



Cod.	Tip	Size (mm)	Cod.	Tip	Size (mm)	Cod.	Tip	Size (mm)
BX0006		ø 37 h 42	BX0060		ø 37 h 42	BX0004		ø 37 h 42



Cod.	Tip	Size (mm)	Cod.	Tip	Size (mm)	Cod.	Tip	Size (mm)
BX0011		ø 37 h 42	BX0055		ø 37 h 42	BX0056		ø 37 h 42



Cod.	Tip	Size (mm)	Cod.	Tip	Size (mm)	Cod.	Tip	Size (mm)
BX0002		ø 37 h 42	BX0008		ø 37 h 42	BX0058		ø 37 h 42



Cod.	Tip	Size (mm)	Cod.	Tip	Size (mm)	Cod.	Tip	Size (mm)
BX0059		ø 37 h 42	BX0016		ø 37 h 42	BX0023		ø 37 h 42



Cod.	Tip	Size (mm)	Cod.	Tip	Size (mm)	Cod.	Tip	Size (mm)
BX0052		ø 35 h 38	BX0054		ø 37 h 42	BX0053		ø 35 h 38



Cod.	Tip	Size (mm)	Cod.	Tip	Size (mm)	Cod.	Tip	Size (mm)
BX 2117	ø 1	ø 25 h 39,5	BX 2219	ø 2	ø 31 h 36,5	BX0012	ø 23	ø 37 h 42



Cod.	Tip	Size (mm)	Cod.	Tip	Size (mm)	Cod.	Tip	Size (mm)
BX 1713	ø 2	ø 25 h 38	BX 1605	8	ø 18 h 44,7	BX0062		ø 37 h 42



Cod.	Tip	Size (mm)	Cod.	Tip	Size (mm)	Cod.	Tip	Size (mm)
BX0035	5 x 1	ø 18 h 35	BX 1105	17 x 2	ø 25 h 43	BX0041	10	ø 18 h 34
BX0036	7 x 1,5	ø 18 h 35	BX 1115	18	ø 25 h 42			
BX0037	10 x 3	ø 18 h 33	BX 1123	16	ø 25 h 42,7			
			BX 1132	14	ø 25 h 42			

Romias (pack 1 pc)



Cod.	Tip	Size (mm)	Cod.	Tip	Size (mm)
BXB01	ø 31	54 x 54 x 60	BXB02	ø 31	54 x 54 x 57

Fancy/Fantasia (pack 5 pcs)



Cod.	Tip	Size (mm)
BX0001	ø 23	ø 37 h 42



Cod.	Tip	Size (mm)
BX0009	ø 23	ø 37 h 42



Cod.	Tip	Size (mm)
BX 0252	ø 20	ø 31 h 40



Cod.	Tip	Size (mm)
BX0042	ø 5	ø 18 h 30



Cod.	Tip	Size (mm)
BX0048	ø 2	ø 18 h 30



Cod.	Tip	Size (mm)
BX 1820	ø 5	ø 31 h 39



Cod.	Tip	Size (mm)
BX0046	ø 10	ø 18 h 30



Cod.	Tip	Size (mm)
BX0045	ø 7	ø 18 h 31

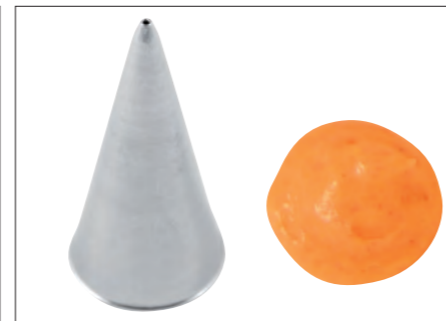

Cod.	Tip	Size (mm)
BX0028	ø 0,4	ø 18 h 37

BX0029	ø 0,6	ø 18 h 35
---------------	-------	-----------

BX0030	ø 0,9	ø 18 h 36
---------------	-------	-----------



Cod.	Tip	Size (mm)
BX0038	ø 8	ø 18 h 28

BX0047	ø 9	ø 18 h 26
---------------	-----	-----------

Spheres/Sfere (pack 1 pc)



Cod.	Tip	Size (mm)
BX0100	ø 22	ø 32 h 60



Cod.	Tip	Size (mm)
BX0101	ø 22	ø 32 h 57



Cod.	Tip	Size (mm)
BX0102	ø 22	ø 32 h 57



Cod.	Tip	Size (mm)
BX0103	ø 22	ø 32 h 57



Cod.	Tip	Size (mm)
BX0104	ø 22	ø 32 h 57

Filling (pack 5 pcs)



Cod.	Tip	Size (mm)
BIM 340	ø 4	ø 25 h 92



Cod.	Tip	Size (mm)
BIM230	ø 5	ø 18 h 75



Cod.	Tip	Size (mm)
BIM 232	ø 8	ø 25 h 92

PIPING TIPS KIT/KIT BOCCHETTE



Floreal

12 floreal mixed piping tips
12 bocchette floreali miste

BOS12FLO



Mixed Big

36 mixed big piping tips + 3 adapters
36 bocchette miste grandi + 3 adattatori

plastic box/scatola in plastica 305 x 245 x 65 mm

BOS 36 BIG



Decor 52

52 mixed decorative piping tips + 1 adapter + 2 flower nails
52 bocchette decorative miste + 1 adattatore + 2 chiodi per fiori

plastic box/scatola in plastica 250 x 190 x 46 mm

BOS 52



Decor 26

26 mixed decorative piping tips + 1 adapter + 2 flower nails
26 bocchette decorative miste + 1 adattatore + 2 chiodi per fiori

plastic box/scatola in plastica 192 x 140 x 46 mm

BOS 26

PIPING TIPS ACCESSORIES/ACCESSORI BOCCHETTE



Brush for piping tips Bruschino per bocchette

Nylon bristle brush with conical shape and plastic handle.
Bruschino con setole in nylon con forma conica e impugnatura in plastica.

BRU



Plexiglass display for nozzles Espositore in plexiglass per bocchette

515 x 315 x 210 mm - Cap. 60 pcs

ESPOB60



Vertical rack with door Portabocchette verticale con anta

310 x 100 x 390 mm - Cap. 36 pcs

ESPOBO32

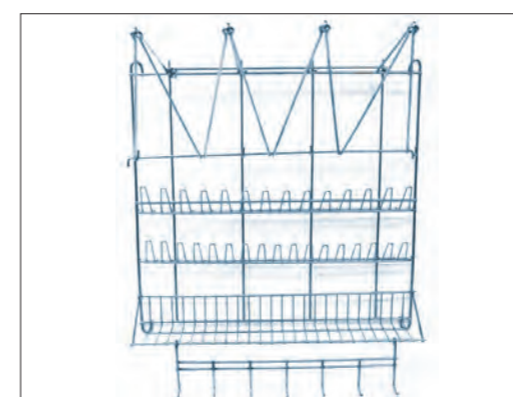

Display for nozzles and bags Espositore per bocchette e sacchetti

510 x 350 x 490 mm

ESPO ST

PASTRY TOOLS



SOFT SPATULAS/SPATOLE MORBIDE



High temperature 230°C

Silicone spoon and fiberglass and nylon handle.
Cucchiaio in silicone e manico in fibra di vetro e nylon.

Cod.	Size	Spoon/ Cucchiaio	Handle/ Manico
50SC350	350 x 65 mm	115 mm	235 mm
50SC400	400 x 65 mm	115 mm	285 mm



Soft spatula 1

Max temp. 70°C

Rubber spoon and ABS handle.
Cucchiaio in gomma e manico in ABS.

Cod.	Size	Spoon/ Cucchiaio	Handle/ Manico
50GO300	310 x 70 mm	115 x 70 mm	195 mm
50GO350	350 x 70 mm	115 x 70 mm	235 mm
50GO400	400 x 70 mm	115 x 70 mm	285 mm



Extra soft spatula

Max temp. 70°C

Extra-soft rubber spoon and ABS handle.
Cucchiaio extra soft in gomma e manico in ABS.

Cod.	Size	Spoon/ Cucchiaio	Handle/ Manico
50GO275	275 x 49 mm	88 x 49 mm	187 mm



Soft spatula 2

Max temp. 70°C

Rubber spoon and hard plastic handle.
Cucchiaio in gomma termoplastica e manico in plastica rigida.

Cod.	Size	Spoon/ Cucchiaio	Handle/ Manico
MEL 250	250 x 50 mm	85 mm	165 mm
MEL 350	350 x 70 mm	115 mm	235 mm
MEL 450	450 x 70 mm	115 mm	335 mm

HARD SPATULAS/SPATOLE RIGIDE



High temperature 220°C

One-piece made of polyamide with fiberglass.
Monopezzo in poliammide con fibre di vetro.

Cod.	Size	Spoon/ Cucchiaino	Handle/ Manico
MEX 250	250 x 45 mm	120 mm	130 mm
MEX 300	300 x 50 mm	120 mm	180 mm
MEX 400	400 x 65 mm	145 mm	255 mm
MEX 500	500 x 70 mm	210 mm	290 mm



Firm spatula

Max temp. 100°C

One-piece made of polypropylene with fiberglass.
Monopezzo in polipropilene con fibre di vetro.

Cod.	Size	Spoon/ Cucchiaino	Handle/ Manico
50SR340	339 x 59 mm	100 x 59 mm	239 mm

ST. STEEL SPATULAS/SPATOLE IN ACCIAIO INOX

Professional spatulas with rigid stainless steel blade, to evenly distribute even the hardest ganaches, yet flexible enough for optimal icing.

Spatole professionali con lama rigida in acciaio inox, per distribuire uniformemente anche le ganache più dure, ma al contempo abbastanza flessibile per un glassaggio ottimale.



Angular blade

Lama angolare

Cod.	Size	Blade/Lama	Handle/ Manico
50SPANG01	230 mm	30 x 100 mm	130 mm
50SPANG02	280 mm	30 x 150 mm	130 mm
50SPANG03	330 mm	30 x 200 mm	130 mm
50SPANG04	380 mm	30 x 250 mm	130 mm



Straight blade

Lama dritta

Cod.	Size	Blade/Lama	Handle/ Manico
50SPA01	230 cm	30 x 100 mm	130 mm
50SPA02	290 mm	30 x 160 mm	130 mm
50SPA03	340 mm	30 x 210 mm	130 mm
50SPA04	390 mm	30 x 260 mm	130 mm

WHISKS/FRUSTE

Made of stainless steel, resistant to high temperatures.
In acciaio inox, resistenti alle alte temperature.



Whisk 8 With hook for hanging.
Con gancio per appendimento.
8 wires/fili.

Cod.	Size	Wire/Filo
50FA01	250 mm	ø 2,2 mm
50FA02	300 mm	ø 2,2 mm
50FA03	350 mm	ø 2,2 mm
50FA04	400 mm	ø 2,2 mm
50FA05	450 mm	ø 2,2 mm
50FA06	500 mm	ø 2,2 mm

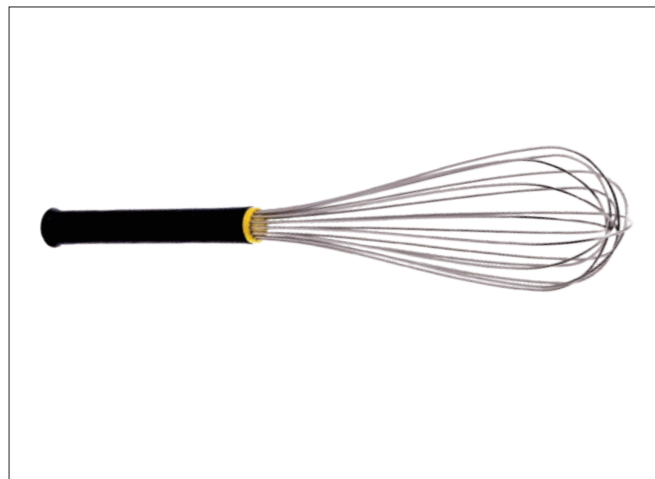

Whisk 16
16 wires/fili

Cod.	Size	Wire/Filo
MFRU 25	250 mm	ø 1,5 mm
MFRU 30	300 mm	ø 1,8 mm
MFRU 35	350 mm	ø 1,8 mm
MFRU 40	400 mm	ø 1,8 mm
MFRU 45	450 mm	ø 2 mm
MFRU 50	500 mm	ø 2 mm

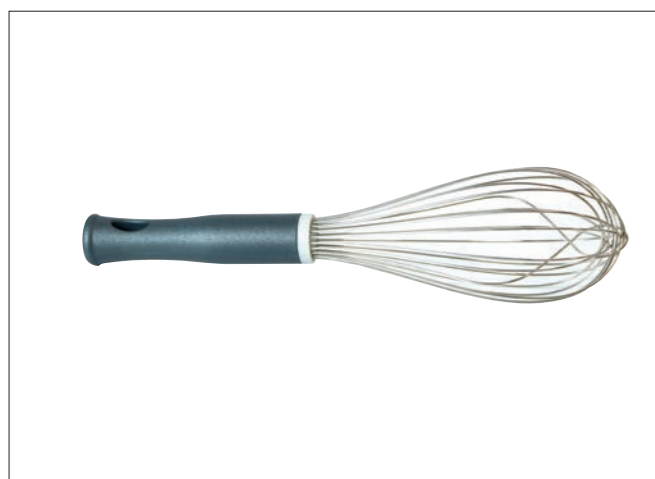

Whisk 11 With hole for hanging. **New**
Con foro per appendimento.
11 wires/fili

Cod.	Size	Wire/Filo
50FN25	250 mm	ø 1,4 mm
50FN30	300 mm	ø 1,4 mm
50FN35	350 mm	ø 1,4 mm
50FN40	400 mm	ø 1,4 mm
50FN45	450 mm	ø 1,4 mm

TWEEZERS/PINZETTE

Made of stainless steel.
In acciaio inox.



Straight tweezer

Cod.	Size
50PI02	20 cm
50PI03	30 cm



Angular tweezer

Cod.	Size
50PI04	20 cm
50PI05	30 cm



Mini tweezer

Cod.	Size
50PI01	16 cm

CHOCO SCRAPERS/RASCHIE PER CIOCCOLATO

Totally Made in Italy, with non-slip, ergonomic handle and stainless steel scratch resistant blade.
Interamente Made in Italy, con impugnatura antiscivolo ergonomica e lama antigraffio in acciaio inox.



Cod.	Size	Handle/Manico	Blade/Lama
50RAS4	180 x 145 mm	135,4 h 130 mm	145 h 50 mm



Cod.	Size	Handle/Manico	Blade/Lama
50RAS5	210 x 145 mm	135,4 h 130 mm	145 h 80 mm



Cod.	Size	Handle/Manico	Blade/Lama
50RAS6	180 x 200 mm	189,7 h 130 mm	200 h 50 mm



Cod.	Size	Handle/Manico	Blade/Lama
50RAS7	225 x 200 mm	189,7 h 130 mm	200 h 95 mm



METAL SCRAPERS/RASCHIE IN METALLO



Cod.	Size	Handle/Manico	Blade/Lama
50RAS1	135 h 105 mm	135 h 25 mm	130 h 80 mm
50RAS2	180 h 105 mm	180 h 20 mm	175 h 80 mm

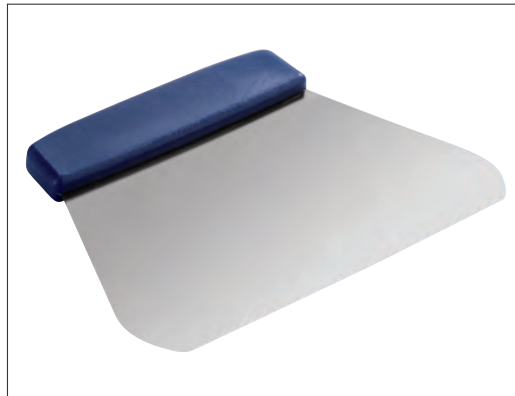

Cod.	Size	Handle/Manico	Blade/Lama
RAS 3	195 h 145	135 h 35 mm	195 h 110 mm



Cod.	Size	Handle/Manico	Blade/Lama
RD105	105 h 105 mm	105 h 25 mm	105 h 80 mm
RD125	125 h 105 mm	125 h 25 mm	125 h 80 mm
RD150	150 h 105 mm	150 h 25 mm	150 h 80 mm
RD175	175 h 105 mm	175 h 25 mm	175 h 80 mm

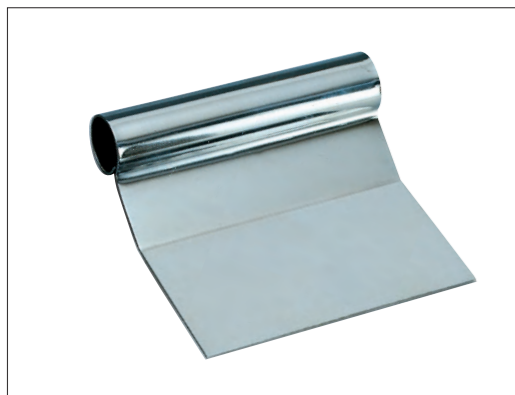

Cod.	Size	Handle/Manico	Blade/Lama
RC115	120 h 115 mm	120 h 25 mm	120 h 90 mm

PLASTIC SCRAPERS/RASCHIE IN PLASTICA

Pack 10 pcs



Cod.	Size
50RTD1	145 x 95 mm rigid/rigido



Cod.	Size
50RTF1	150 x 110 mm rigid/rigido
50RTF2	150 x 110 mm soft/morbido



Cod.	Size
50RTL1	145 x 95 mm rigid/rigido
50RTL2	145 x 95 mm soft/morbido



Cod.	Size
50RTP1	120 x 90 mm rigid/rigido
50RTP2	120 x 90 mm soft/morbido



Cod.	Size
50RTA1	125 x 90 mm rigid/rigido
50RTA2	125 x 90 mm soft/morbido



Cod.	Size
50RTT1	215 x 130 mm rigid/rigido



Cod.	Size
50RTS1	195 x 150 mm rigid/rigido

EXTENSIBLE DOUGH CUTTERS/TAGLIAPASTA ESTENSIBILI

- Made of stainless steel
 - To easily cut dough strips of the same size.
 - Distance of the wheels adjustable from 10 to 120 mm.
 - Wheels can be locked by tightening the wing nuts.
- *In acciaio inox*
 - *Per tagliare facilmente strisce di impasti della stessa misura.*
 - *Distanza ruote regolabile dai 10 ai 120 mm.*
 - *Le ruote possono essere bloccate stringendo i dadi ad alette.*



Single smooth

Single smooth blade
Lama singola liscia

Cod.	Blades/Lame	Wheel size Misura ruota
ROTAPINOX 5 P	5 smooth/lisce	ø 55 mm
ROTAPINOX 7 P	7 smooth/lisce	ø 55 mm

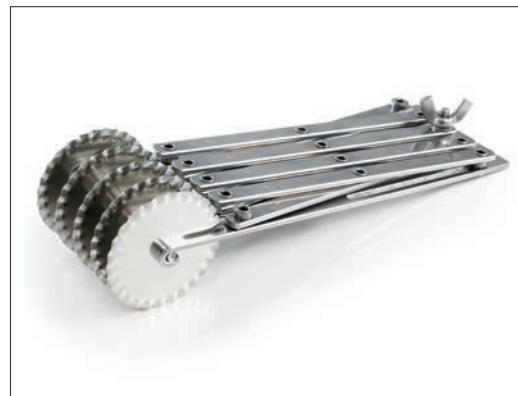

Single curved

Single curved blade
Lama singola ondulata

Cod.	Blades/Lame	Wheel size Misura ruota
ROTAPINOX 5 O	5 curved/ondulate	ø 55 mm
ROTAPINOX 7 O	7 curved/ondulate	ø 55 mm



Double

Double blade smooth and curved
Doppia lama liscia e ondulata

Cod.	Blades/Lame	Wheel size Misura ruota
ROTINOX 5 P/O	5 smooth/lisce + 5 curved/ondulate	ø 55 mm
ROTINOX 7 P/O	7 smooth/lisce + 7 curved/ondulate	ø 55 mm



DOUGH CUTTER ACCESSORIES/ACCESSORI TAGLIAPASTA



Pastry cutter

Rotella tagliapasta

Cod.	Size
PC100	∅ 100 mm
PC120	∅ 120 mm
PC55	∅ 55 mm
PC65	∅ 65 mm



Cutter for tarts

Griglia tagliapasta per crostate

Cod.	Size
DECOR 30	∅ 30 cm

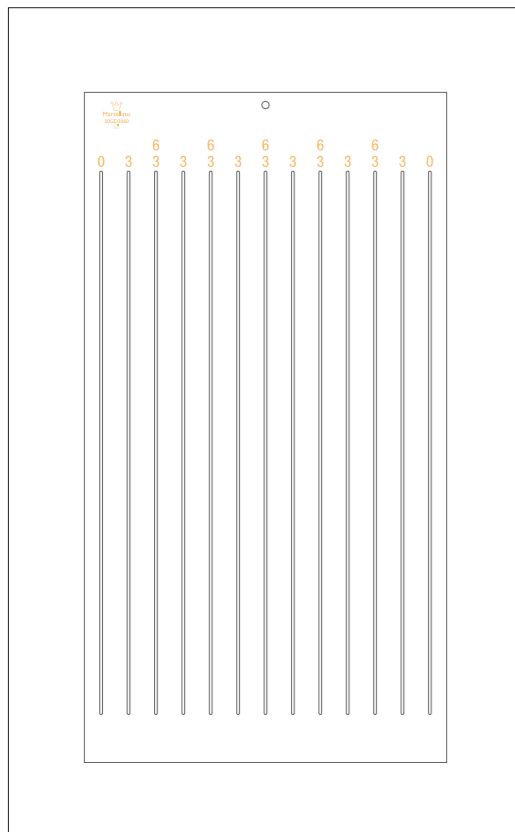

Templates

Transparent plastic cutting grid for cutting regular strips of shortcrust pastry, chocolate, biscuit, etc.
Dima di taglio in plastica trasparente per il taglio in strisce regolari di pasta frolla, cioccolato, biscuit, ecc.

Cod.	Size	Cutting size Misura taglio
50GD0015	510 x 400 mm	1,5 cm
50GD0018	510 x 400 mm	1,8 cm
50GD0022	60 h 22 mm	2,2 cm
50GD0027	60 h 27 mm	2,7 cm
50GD0037	60 h 37 mm	3,7 cm
50GD2040	740 x 400 mm	2-4 cm
50GD3060	740 x 400 mm	3-6 cm

PASTRY DOCKERS/RULLI FORAPASTA

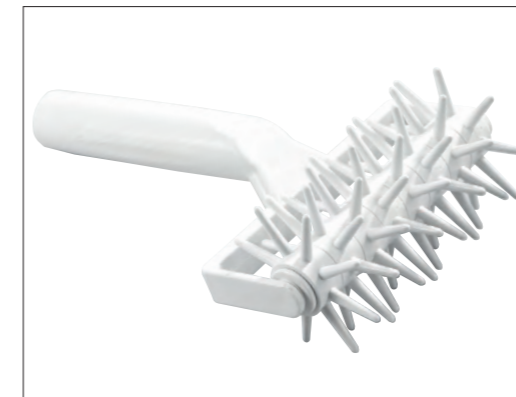

Plastic pastry docker
Rullo forapasta in plastica

Cod.	Size
RFP 12	120 mm



Lozenge plastic docker
Rullo per losanghe in plastica

Cod.	Size
RPL 12	120 mm



Aluminium pastry docker
Rullo forapasta in alluminio

Cod.	Size
50RFP12A	120 mm

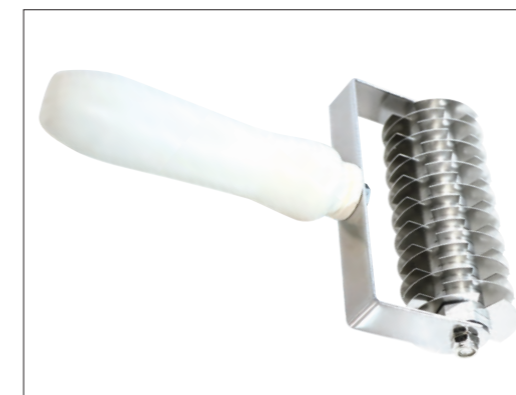

Lozenge st. steel docker
Rullo per losanghe in acciaio inox

Distance between blades/distanza tra le lame: 7 mm

Cod.	Size
50RPL12X	120 mm

CROISSANT CUTTERS/TAGLIA CROISSANT

Cutting size refers to the triangle of dough.
La misura di taglio si riferisce al triangolo di pasta.

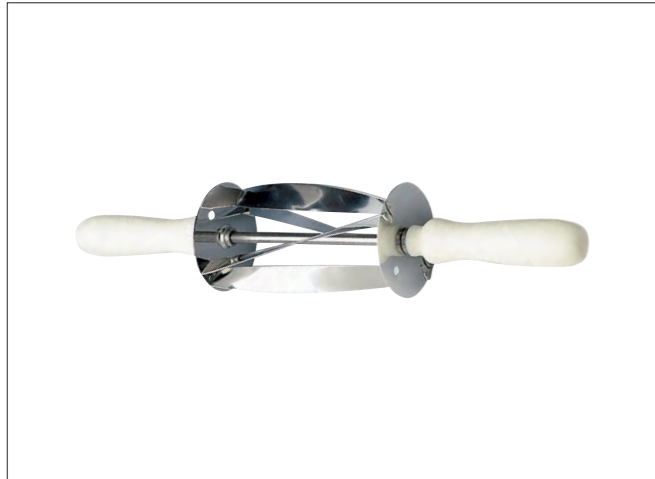

Cod.	Size	Cutting size Misura di taglio
RSC180X140	400 x 120 h 120 mm	177 x 141 mm
RSC180X200	460 x 120 h 120 mm	180 x 200 mm
RSC70X100	360 x 55 h 55 mm	70 x 100 mm
RSC96X153	410 x 70 h 70 mm	96 x 153 mm
RSC97X210	470 x 70 h 70 mm	98 x 208 mm

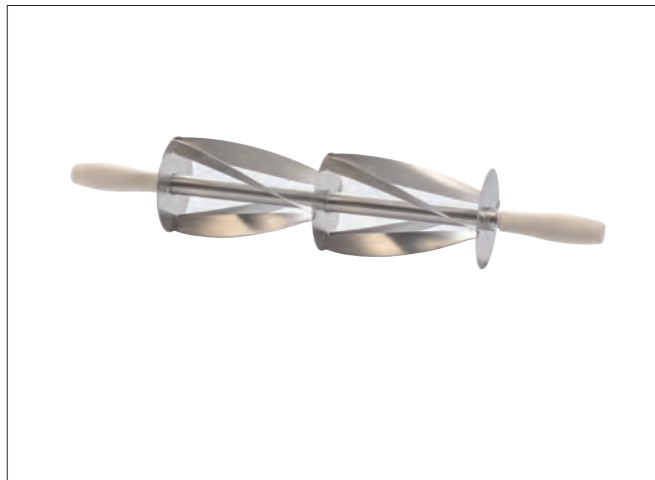

Cod.	Size	Cutting size Misura di taglio
RDC180X200	670 x 120 h 120 mm	180 x 200 mm



Cod.	Size	Cutting size Misura di taglio
RTC180X200	880 x 120 h 120 mm	180 x 200 mm

GRATER & ZESTER/GRATTUGIE & ZESTER

Stainless steel blade, non-slip soft touch handle and a protective case.
Lama in acciaio inox, manico soft touch antiscivolo e custodia protettiva.



Yellow zester

32 cm

50ZES01



Red zester

32 mm

50ZES02



Black zester

32 mm

50ZES03

BOWLS & FLOUR SCOOPS/CIOTOLE & SESSOLE



Transparent polycarbonate.
Policarbonato trasparente.

Cod.	Size	Cap.
52BO13PC	ø 13 cm	0,4 l
52BO17PC	ø 17 cm	1 l
52BO23PC	ø 23 cm	2,5 l
52BO28PC	ø 28 cm	4 l
52BO32PC	ø 32 cm	8 l
52BO38PC	ø 38 cm	10 l



White polypropylene.
Polipropilene bianco.

Cod.	Size	Cap.
52BO13PP	ø 13 cm	0,4 l
52BO17PP	ø 17 cm	1 l
52BO23PP	ø 23 cm	2,5 l
52BO28PP	ø 28 cm	4 l
52BO32PP	ø 32 cm	8 l
52BO38PP	ø 38 cm	10 l



White plastic.
Plastica bianca.

Cod.	Size	Spoon/ Cucchiaino	Cap.
SES 100	18,5 x 6,5 cm	11 x 6,5 cm	125 ml
SES 250	25 x 9 cm	15 x 9 cm	250 ml
SES 500	31 x 11,7 cm	19 x 11,7 cm	512 ml
SES 800	34,5 x 14,5 cm	23 x 14,5 cm	857 ml
SES 1500	40 x 17,5 cm	27,5 x 17,5 cm	1520 ml

ROLLING PINS/RULLI

Size excluding handles.
Misura manici esclusi.



Wooden rolling pins.
Rulli in legno.

Cod.	Size
RL 2	ø 8 x 50 cm
RL 3	ø 7 x 60 cm
RL 4	ø 8 x 60 cm



Revolving wooden rolling pins.
Rulli in legno girevoli.

Cod.	Size	Cod.	Size
RLS 30	ø 8 x 30 cm	RLS 45	ø 8 x 45 cm
RLS 35	ø 8 x 35 cm	RLS 50	ø 8 x 50 cm
RLS 40	ø 8 x 40 cm	RLS 60	ø 8 x 60 cm



Polyethylene rolling pins.
Rulli in polietilene.

Cod.	Size
RLS50PE	ø 7 x 30 cm
RLS60PE	ø 7 x 40 cm
RLS70PE	ø 7 x 50 cm

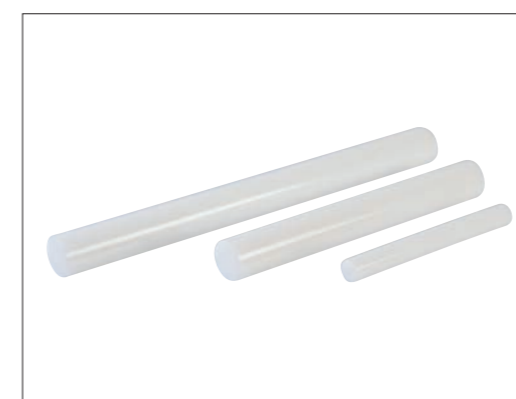

Polyethylene rolling pins for sugar paste and chocolate.
Rulli in polietilene per pasta di zucchero e cioccolato.

Cod.	Size
40-W021	ø 2,5 x 23 cm
40-W022	ø 4,5 x 50 cm
40-W154	ø 4,5 x 35 cm

BRUSHES/SPAZZOLE



Natural bristles.
Setole naturali.

Cod.	Size
SPZ SE	400 x 40 mm



Polyester bristles.
Setole in poliestere.

Cod.	Size
SPZ PL1	240 x 75 mm



Stainless steel bristles.
Setole in acciaio inox.

Cod.	Size
SPZ INOX	145 x 55 mm

BRUSHES/PENNELLI



Professional cooking brush
Pennello professionale per cucina

Cod.	Bristles/Setole
50PE30	30 mm
50PE40	40 mm
50PE50	50 mm
50PE60	60 mm
50PE70	70 mm

Synthetic bristles, heat resistant up to 120°C.
Dishwasher safe. *Con setole sintetiche, resiste fino a 120°C. Lavabile in lavastoviglie.*

PINCER/PINZA



Made of plastic.
In plastica.

Cod.	Size
PINZA	29,5 x 8 cm



RACKS/GRIGLIE

Metal.
Metallo.



Cod.	Size
PR30	ø 300 mm
PR40	ø 400 mm

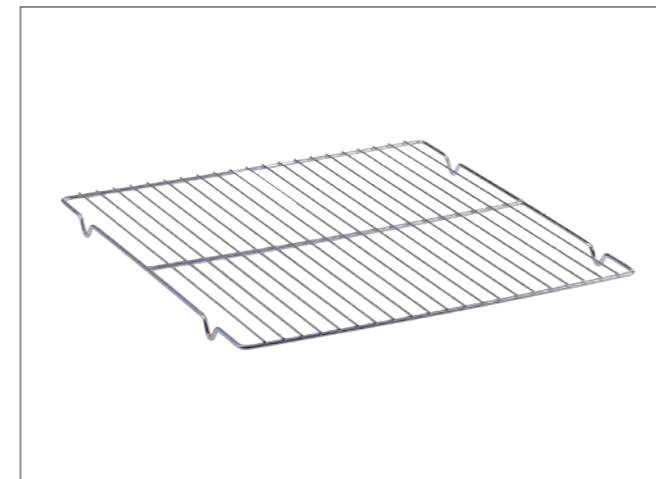

Cod.	Size
PR30X30	300 x 300 mm
PR50X50	500 x 500 mm

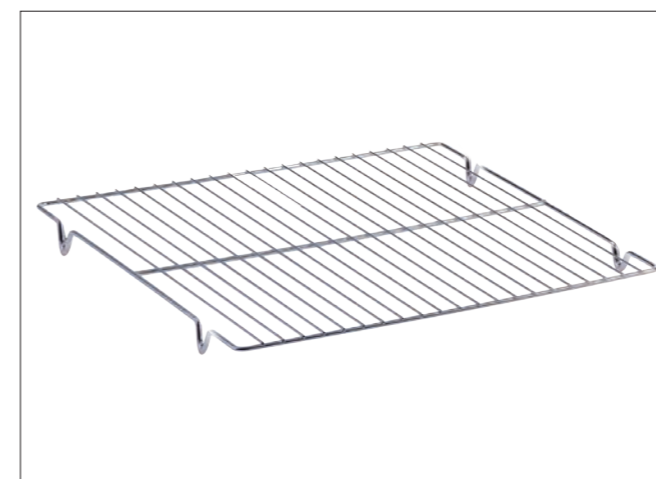

Higher feet, suitable to use with trays.
I piedini più alti consentono l'utilizzo con le teglie.

Cod.	Size
PR40X60	588 x 390 h 25 mm

BREAD MOULDS/STAMPI PANE

Plastic.
Plastica.



Cod.	Size	Type
STPTA 1	14 x 10 cm	Square turtle tartaruga quadrata



Cod.	Size	Type
STPTA 2	14 x 11 cm	Hexagonal turtle Tartaruga esagonale



Cod.	Size	Type.
STPTA 5	ø 12,5 cm	Daisy Margherita

BREAD BASKETS/CESTINI PANE

Plastic.
Plastica.



Cod.	Size	Cap.
BASKET 205	ø 25 cm	1500 gr
BASKET 206	ø 21,5 cm	1000 gr
BASKET 207	ø 18 cm	500 gr
BASKET 208	ø 13 cm	250 gr



Cod.	Size	Cap.
BASKET 105	40 x 14 cm	1500 gr
BASKET 106	35 x 13 cm	1000 gr
BASKET 107	27 x 12 cm	500 gr



Cod.	Size	Cap.
BASKET 102	29 x 18 cm	1000 gr
BASKET 103	22 x 14 cm	500 gr
BASKET 108	24 x 14 cm	750 gr

BOTTLES & CARAFES/FLACONI & CARAFFE



Graduated bottle
Flacone graduato

Cod.	Size	Cap.
50FL00	100 x 56 h 275 mm	1000 ml no cap
50FL00C	100 x 56 h 275 mm	1000 ml with cap



Graduated bottle
Flacone graduato

Cod.	Size	Cap.
FLACONE	70 x 70 h 270 mm	1000 ml



Graduated bottle
Flacone graduato

Cod.	Size	Cap.
50FLAN2	ø 70 h 195 mm	500 ml
FLAN1	ø 85 h 250 mm	1000 ml



Graduated spraying bottle
Flacone nebulizzatore graduato

Cod.	Size	Cap.
50FLAN2T	ø 70 h 225 mm	500 ml
FLACONE2	70 x 70 h 300 mm	1000 ml



Graduated dosage bottle
Flacone dosatore graduato

Cod.	Size	Cap.
BO100N	ø 40 h 138 mm	100 ml
BO250N	ø 50 h 194 mm	250 ml
BO500N	ø 60 h 253 mm	500 ml
BO1000N	ø 79 h 283 mm	1000 ml



Graduated carafe
Caraffa graduata

Cod.	Cap.
CFTRA 1	500 ml
CFTRA 2	1000 ml
CFTRA 3	2000 ml
CFTRA 4	3000 ml



Graduated carafe
Caraffa graduata

Cod.	Cap.
CFTRA6	6000 ml no lid
CFTRA6C	6000 ml with lid

CUTTERS/TAGLIERINI



Wavy blade cutter
Taglierino a lama ondulata

Cod.	Size
CUTTER 8	90 mm



Wavy blade cutter
Taglierino a lama ondulata

Cod.	Size
50COL51	80 mm

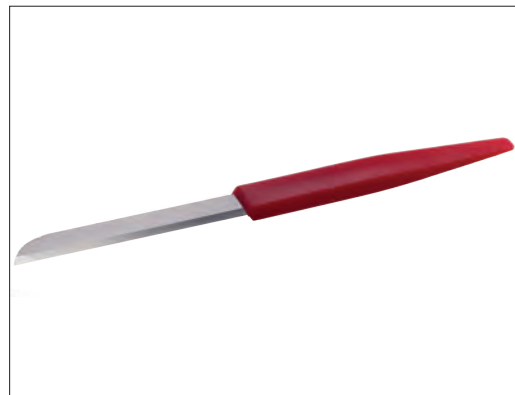

Plain blade cutter
Taglierino a lama liscia

Cod.	Size
CUTTER 7	90 mm



Plain blade cutter
Taglierino a lama liscia

Cod.	Size
50COL50	70 mm



Spoon knife with revolving blade
Coltellino a cucchiaio con lama girevole

Cod.	Size
CUTTER 4	130 mm



Spoon knife with fixed blade
Coltellino a cucchiaio con lama fissa

Cod.	Size
CUTTER 1	130 mm

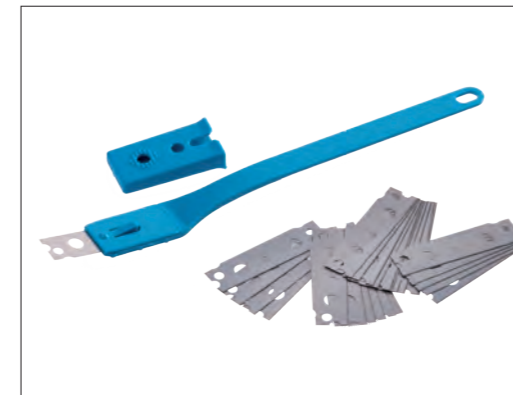

Knife with fixed blade + 25 spare blades
Coltellino a lama fissa + 25 ricambi

Cod.	Size
CUTTER 5	145 mm

GLOVES/GUANTI



Leather gloves Manopole in pelle

Foam inner lining
Interno in gommapiuma

CE marking: II CAT. EN 388:2016 EN 407:2004

Cod.	Size	°C max
GL 1	380 x 150 mm	+250



Cotton gloves Manopole in cotone

Cod.	Size
GL10	270 x 150 mm



Long leather gloves Manopole in pelle lunghe

Cotton inner lining
Interno in cotone

CE marking: II CAT. EN 388:2016 EN 407:2004

Cod.	Size	°C max
GL 2	450 x 150 mm	+250



Long cotton gloves Manopole in cotone lunghe

Cod.	Size
GL11	340 x 150 mm



Three finger leather gloves Guanti in pelle a tre dita

Cotton inner lining
Interno in cotone

CE marking: II CAT. EN 388:2016 EN 407:2004

Cod.	Size	°C max
GL 3	27 x 15 cm	+250



Leather oven mitts Presine per forno in pelle

Cod.	Size
GL18PRE	180 x 250 mm
GL25PRE	250 x 350 mm

TORCHES/CANNELLI

Professional and multifunctional butane torches for pastry, gastronomy and cooking: ideal for caramelizing sugar and meringues, grating, heating and melting. With non-slip handle.

Cannelli a butano professionali e multifunzionali per pasticceria, gastronomia e cucina: ideali per caramellare zucchero e meringhe, gratinare, scaldare e sciogliere. Impugnatura antiscivolo.



Flambè Premium **New**

with rotating angles
con testa rotante

Max temp 1300°C (2400°F)

64 ml refillable tank (gas not included).
Adjustable blue flame, with button for continuous flame.
Serbatoio ricaricabile da 64 ml (gas non incluso).
Fiamma blu regolabile, con pulsante per fiamma continua.

50CA01



Flambè Pro

Max temp 1300°C (2400°F)

140 ml refillable tank (gas not included).
Adjustable blue flame, with button for continuous flame.
Serbatoio ricaricabile da 140 ml (gas non incluso).
Fiamma blu regolabile, con pulsante per fiamma continua.

CANNELLOPRO



Flambè Mini **New**

Max temp 1300°C (2400°F)

Adjustable blue flame, with button for continuous flame
(gas not included).
Fiamma blu regolabile, con pulsante per fiamma continua
(gas non incluso).

50CA02



Cannello Big

Power: 1,90 kW - nozzle: 0.28 mm.
Adjustable flame, with button for continuous flame.
To be used with disposable gas cylinder (not included).
Potenza: 1,90 kW - ugello: 0,28 mm.
Fiamma regolabile, con pulsante per fiamma continua.
Usare con bombola di gas usa e getta (non inclusa).

CANNELLOBIG

THERMOMETERS/TERMOMETRI



Infrared thermometer Termometro ad infrarossi

Digital infrared thermometer with LCD display.
Ideal for chocolate.
*Termometro digitale ad infrarossi con display LCD.
Ideale per cioccolato.*

Cod.	Temp. range °C
50T002	from -50°C to 420



Immersion thermometer New Termometro ad immersione

Electronic thermometer with small immersion probe, very handy.
Termometro elettronico con sonda ad immersione di piccole dimensioni, molto maneggevole.

Cod.	Temp. range °C
50T004	from -50°C to 300



Immersion thermometer Termometro ad immersione

Digital thermometer with immersion probe and cable and integrated timer.
Termometro digitale con sonda ad immersione e cavetto e timer integrato.

Cod.	Temp. range °C
50T003	from -50°C to 300



Double probe digital thermometer New Termometro digitale a doppia sonda

Digital thermometer with built-in rotation probe and wire probe with plug. Wire length: 100 cm.
Termometro digitale con sonda di rotazione incorporata e sonda a filo con spina. Lunghezza filo: 100 cm.

Cod.	Temp. range °C
50T005	from -50°C to 300

PISTON FUNNELS/COLINI

Professional stainless steel piston funnel ideal for dosing small quantities of product into small glasses or into the special moulds.

Colino professionale in acciaio inox ideale per dosare piccole quantità di prodotto nei bicchierini o negli appositi stampi.



Colino Small

800 ml

The package includes a metal pedestal and three nozzles of $\varnothing 2$, $\varnothing 4$ and $\varnothing 5$ mm.

La confezione comprende un piedistallo in metallo e tre bocchette da $\varnothing 2$, $\varnothing 4$ e $\varnothing 5$ mm.

50CO001



Colino Big

1900 ml

The package includes a metal pedestal and three nozzles of $\varnothing 4$, $\varnothing 5$ and $\varnothing 6$ mm.

Dishwasher safe.

La confezione comprende un piedistallo in metallo e tre bocchette da $\varnothing 4$, $\varnothing 5$ e $\varnothing 6$ mm.

Lavabile in lavastoviglie.

50CO002

CREAM WHIPPER/SIFONE

Professional stainless steel cream siphon, suitable for the quick preparation of whipped cream, mousse sponges, sauces and the garnishing of coffee, ice cream and desserts.

Sifone per panna professionale in acciaio inox, adatto alla preparazione veloce di panna montata, spugne mousse, salse e alla guarnizione di caffè, gelati e dolci.



Cream Whipper

The kit includes: a bottle, a head with silicone gasket, 3 spouts and a steel capsule holder.

Il kit comprende: una bottiglia, una testata con guarnizione in silicone, 3 beccucci e porta capsule in acciaio.

Cod.	Size	Cap.
50SI01	$\varnothing 8$ h 31 cm	500 ml
50SI02	$\varnothing 9,5$ h 37 cm	1000 ml



Cod.	Pack
50SIR01	Cream charges Ricariche per sifone 10 pcs

CAKE TURNTABLES/GIRATORTA



Anodized aluminium cake turntable Giratorta in alluminio anodizzato

Resistant to abrasion, acids and easy to clean.
Perfectly planar.
*Resistente alle abrasioni, agli acidi e facile da pulire.
Perfettamente planare.*

Cod.	Size	Max weight supported/ peso max supportato
GIRA6	ø 30 h 13 cm	100 kg



High plastic cake turntable Giratorta alto in plastica

Cod.	Size
GIRA	ø 32 h 10 cm



Aluminium cake turntable Giratorta in alluminio

Resistant and planar.
Resistente e planare.

Cod.	Size	Max weight supported/ peso max supportato
GIRA5	ø 29 h 13 cm	100 kg



Low plastic cake turntable Giratorta basso in plastica

Rubber feet guarantee a perfect adherence to the work surface.
I piedini in gomma garantiscono una perfetta aderenza al piano di lavoro.

Cod.	Size	Max weight supported/ peso max supportato
GIRA7	ø 31 h 3,2 cm	3 kg



Tilting plastic cake turntable Giratorta inclinabile in plastica

Tiltable up to 20° with non-slip mat to keep cakes of different weights in position.
Inclinabile fino a 20° con tappeto antiscivolo per mantenere in posizione dolci di diversi pesi.

Cod.	Size
40-W125	ø 23 h 14 cm



St. steel cake lifter Pala per dolci in acciaio

Cod.	Size
TS1	ø 28 cm



FRAMES SET/KIT DI TELAI

Set of frames designed for multilayer preparations such as cremini, biscuits, fruit jellies and ganaches with constant weight and height.

Kit di telai pensati per preparazioni multistrato come cremini, biscuit, gelatine di frutta e ganache con peso ed altezza costanti.



Internal size 360 x 360 mm Misura interna 360 x 360 mm

The complete kit contains: 2 frames h 3 mm, 2 frames h 5 mm, 1 plastic raplette and a polyethylene base.

Il kit completo contiene: 2 telai h 3 mm, 2 telai h 5 mm, 1 raplette in plastica e una base in polietilene.

Cod.	Size
50TLSPECIAL	complete kit 36 x 36 cm

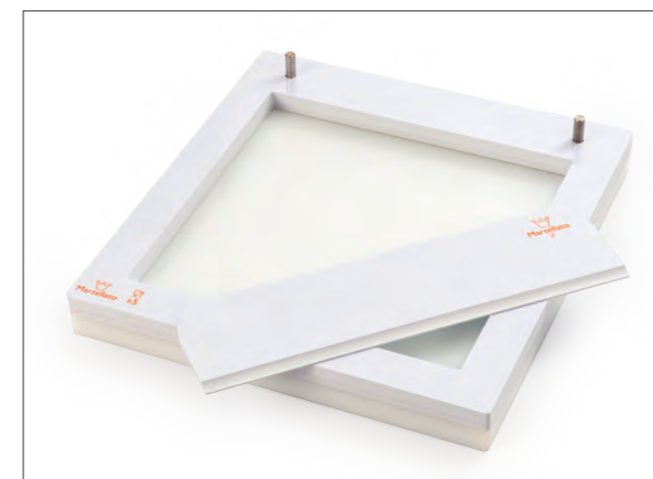

Internal size 240 x 240 mm Misura interna 240 x 240 mm

The complete kit contains: 2 frames h 3 mm, 2 frames h 5 mm, 1 plastic raplette and a polyethylene base.

Il kit completo contiene: 2 telai h 3 mm, 2 telai h 5 mm, 1 raplette in plastica e una base in polietilene.

Cod.	Size
50TLMINI	complete kit 24 x 24 cm



Spare part frames Ricambi telai

Cod.	Size	50TLSPECIAL	50TLMINI
50TLS03	360 x 360 h 3 mm	✓	
50TLS05	360 x 360 h 5 mm	✓	
50TLM03	240 x 240 h 3 mm		✓
50TLM05	240 X 240 h 5 mm		✓

SINGLE FRAMES/TELAI SINGOLI

Single frames to produce perfect layers made of chocolate, biscuit and other doughs.

Telai singoli per creare precise stratificazioni in cioccolato, biscuit e altri impasti.

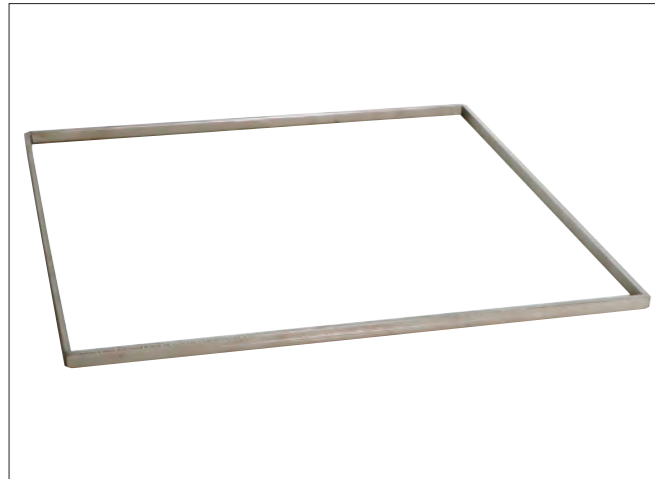

St. steel single frames
Telai singoli in acciaio

Cod.	Internal size Misura interna	External size Misura esterna
50QG03	360 x 360 mm	380 x 380 h 3 mm
50QG05	360 x 360 mm	380 x 380 h 5 mm
50QG10	360 x 360 mm	380 x 380 h 10 mm
50QG15	360 x 360 mm	380 x 380 h 15 mm

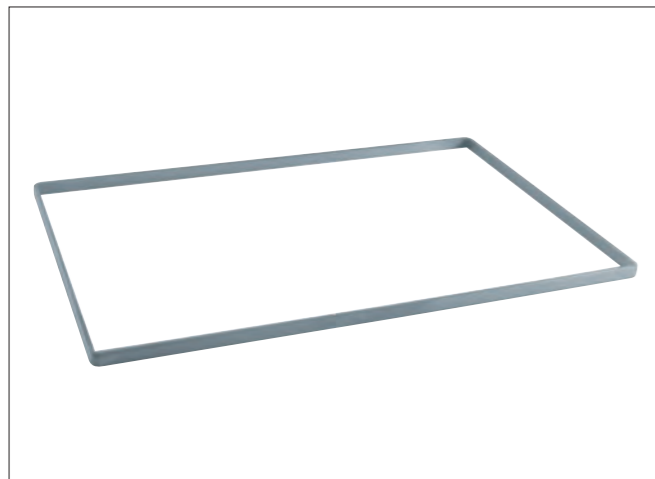

St. steel charlotte frame
Telaio in acciaio per charlotte

Cod.	Internal size Misura interna	External size Misura esterna
TL 15	380 x 580 mm	390 x 590 h 15 mm

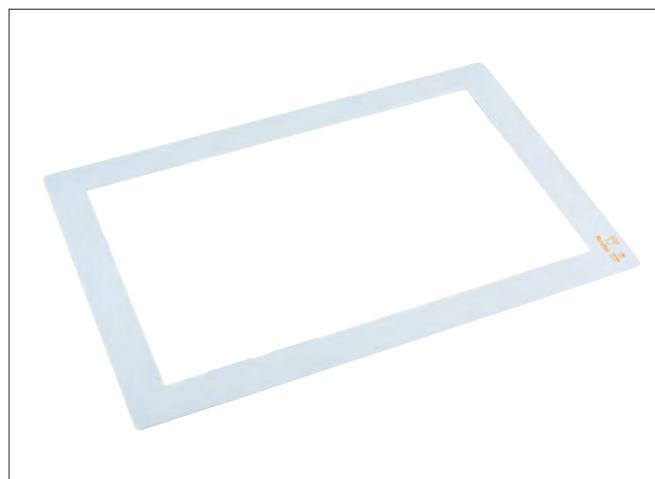

Single plastic frames
Telai singoli in plastica

Cod.	Internal size Misura interna	External size Misura esterna
TL 03	370 x 570 mm	470 x 670 h 3 mm
TL 04	370 x 570 mm	470 x 670 h 4 mm
TL 05	370 x 570 mm	470 x 670 h 5 mm

RAPLETTE/RACLA



Plastic raplette
Racla in plastica

Cod.	Size	Suitable frame Telaio adatto
50SPB30	300 h 80 mm	50TLMINI
50SPB43	430 h 80 mm	50TLSPECIAL
CSMSPB40	420 h 120 mm	CSM040
CSMSPB60	620 h 140 mm	CSM060



Stainless steel raplette.
Raplette in acciaio inox.

Adjustable in both height and width.
External size: 50 x 18 h 6 cm.
Regolabile sia in altezza che in larghezza.
Misura esterna: 50 x 18 h 6 cm.

Cod.	Size	Max height Altezza max
SPB SPECIAL	40 cm	0,1 - 1,8 cm



Drilled grid for disks, thickness 8 mm
Dima forata per dischi, spessore 8 mm

Food-grade plastic, dishwasher safe.
In plastica alimentare, lavabile in lavastoviglie.

Cod.	Size	Prod.
50DF138	ø 13,5 cm	8 pcs
50DF158	ø 15,5cm	6 pcs
50DF178	ø 17,5cm	6 pcs
50DF198	ø 19,5cm	4 pcs



Ciok



Plastic dosing machine for making "Roches", puffed rice biscuits, chocolate mixes, soft biscuit doughs, meringues and other products. The kit consists of a plastic frame without bottom, two perforated trays (ø 30 - 40 mm) and a plastic spatula.

Dosatrice in plastica per realizzare "Roches", biscotti con riso soffiato, miscele di cioccolato, impasti per biscotti morbidi, meringhe e altri prodotti. Il kit è composto da un telaio in plastica senza fondo, due teglie forate (ø 30 - 40 mm) e una spatola in plastica.

60 x 40 h 5 cm

CIOK 1

SCALES/BILANCE

Touch panel, tare function, overload indicator, low power indicator. Range from 1 gr to 5 kg. Batteries included.

Pannello touch, funzione tara, indicazione di sovraccarico, indicatore di bassa potenza. Range da 1 gr a 5 kg. Batterie incluse.



Small scale

Tempered glass surface.
Superficie in vetro temperato.

22 x 16 cm

50BI01



Big scale

Stainless steel surface.
Superficie in acciaio inossidabile.

26 x 31 cm

50BI02

GENERAL EQUIPMENT/ATTREZZATURE VARIE



St. steel sieves
Setacci in acciaio

Cod.	Size
SETAC 16	ø 160 mm
SETAC 19	ø 190 mm
SETAC 21	ø 210 mm
SETAC 24	ø 240 mm
SETAC 26	ø 260 mm
SETAC 28	ø 280 mm
SETAC 30	ø 300 mm



St. steel cake markers
Segnaporzioni in acciaio

Cod.	Size	Portions
PPT8X	ø 330 mm	8
PPT10X	ø 330 mm	10
PPT12X	ø 330 mm	12
PPT14X	ø 330 mm	14
PPT16X	ø 330 mm	16
PPT18X	ø 330 mm	18



Sponge cake slicer
Lira per pan di spagna

3 variable height blades
3 lame con altezza variabile.

Cod.	Size	Blades high Altezza lame
CS3	460 mm	from 0 to 90 mm
CSL	ricambio lama/spare blade	



Universal optical refractometer
Rifrattometro ottico universale

0-90% Brix scale
Accurately measures the percentage concentration of solids in a fluid solution.
Scala 0-90% Brix
Misurare con precisione la concentrazione percentuale di sostanze solide in una soluzione fluida.

Cod.	Size
50RI01	ø 3,8 x 14 cm



Plastic price card
Segnaprezzo in plastica

Cod.	Size	Pack
SEG006N	60 x 80 mm	40 pcs



Plastic price card
Segnaprezzo in plastica

Cod.	Size	Pack
SEG002N	60 x 80 mm	25 pcs

DECORATIVE TOOLS

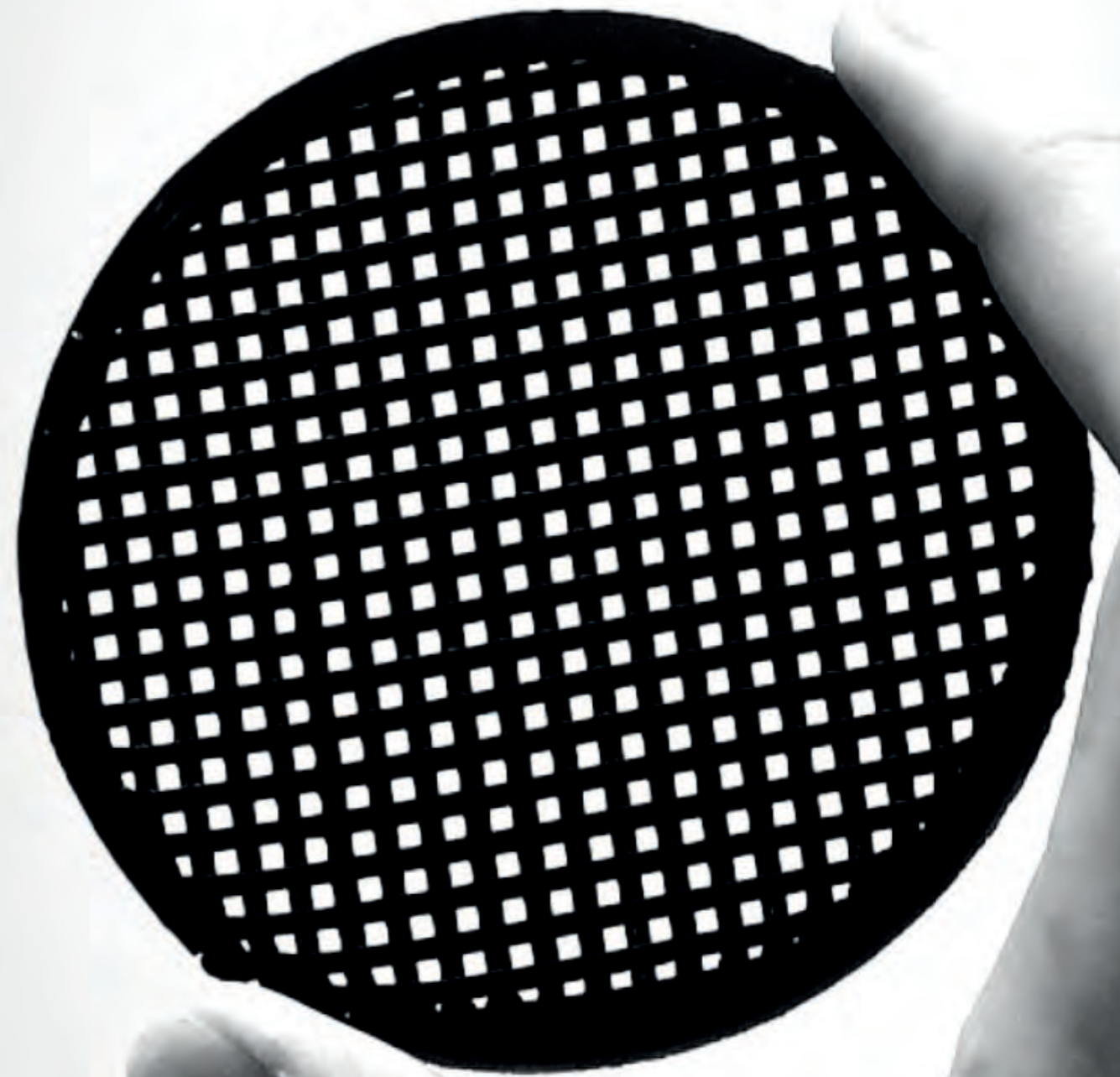

COMBS/PETTINI

Comb, made of plastic and rubber, designed for making chocolate or biscuit decorations. Each comb features a double pattern for decoration.

Pettine, in materiale plastico e gomma, pensato per la realizzazione di decori in cioccolato o biscuit. Ogni pettine presenta un doppio pattern per il decoro.



Watch
the video
how to use

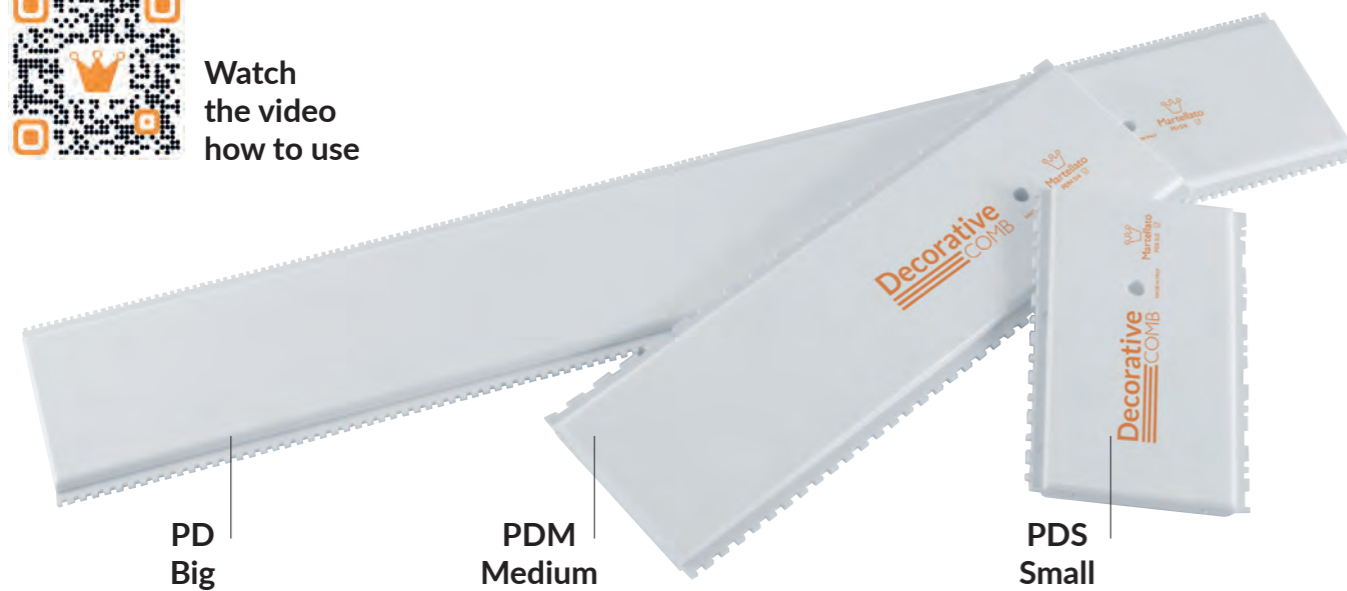

PD
Big

PDM
Medium

PDS
Small



Deco 1

Cod.	Size
PD 1/2	70 cm
PDM 1/2	34 cm
PDS1/2	17 cm



Deco 2

Cod.	Size
PD 3/4	70 cm
PDM 3/4	34 cm
PDS3/4	17 cm



Deco 3

Cod.	Size
PD13/14	70 cm

MATS/TAPPETI

Silicone mats for decorated biscuit production.
Tappeti in silicone per la produzione di biscuit decorato.

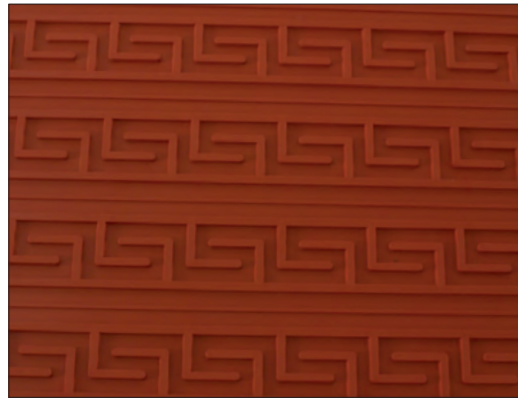

Cod.	Size	Decoration Decoro
RELIEF 1	56,5 x 36,7 cm	h 37 mm

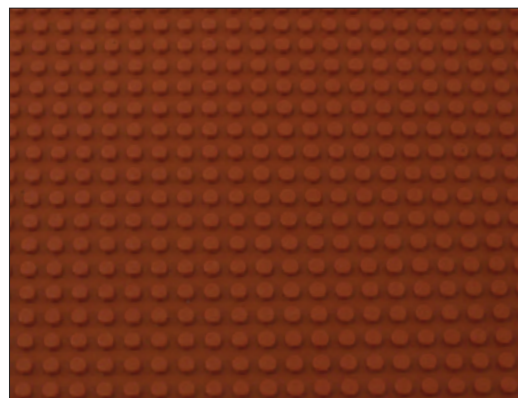

Cod.	Size	Decoration Decoro
RELIEF 2	56,5 x 36,7 cm	ø 4 mm



Cod.	Size	Decoration Decoro
RELIEF 4	56,5 x 36,7 cm	h 30 mm



Cod.	Size	Decoration Decoro
RELIEF 5	56,5 x 36,7 cm	h 30 mm



Cod.	Size	Decoration Decoro
RELIEF 7	56,5 x 36,7 cm	h 30 mm

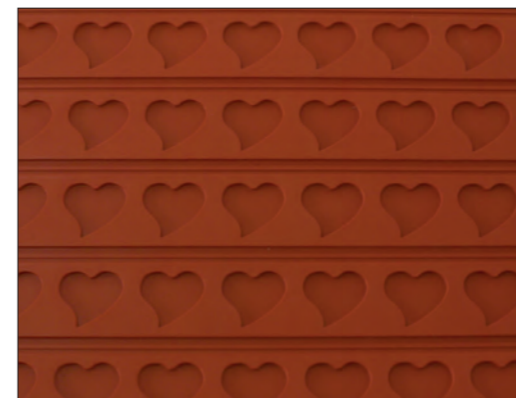

Cod.	Size	Decoration Decoro
RELIEF 9	56,5 x 36,7 cm	h 30 mm

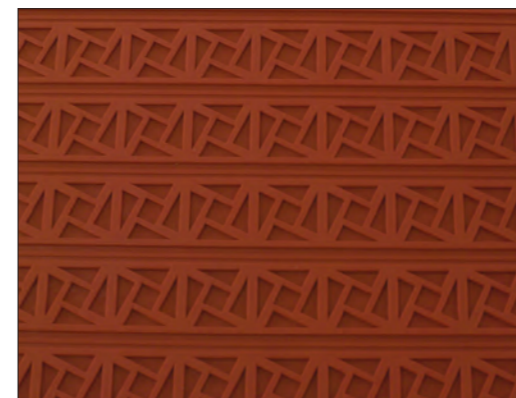

Cod.	Size	Decoration Decoro
RELIEF 11	56,5 x 36,7 cm	h 30 mm

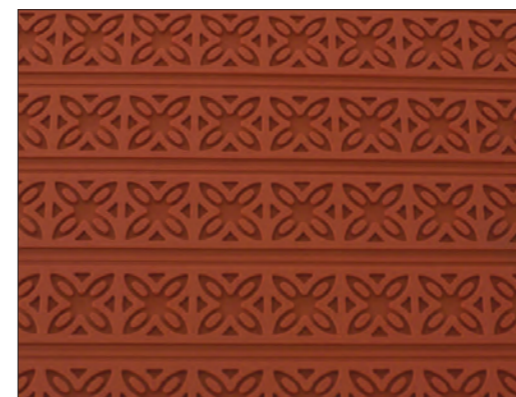

Cod.	Size	Decoration Decoro
RELIEF 12	56,5 x 36,7 cm	h 30 mm

DECORATING TOOLS/ATTREZZI DECORATIVI

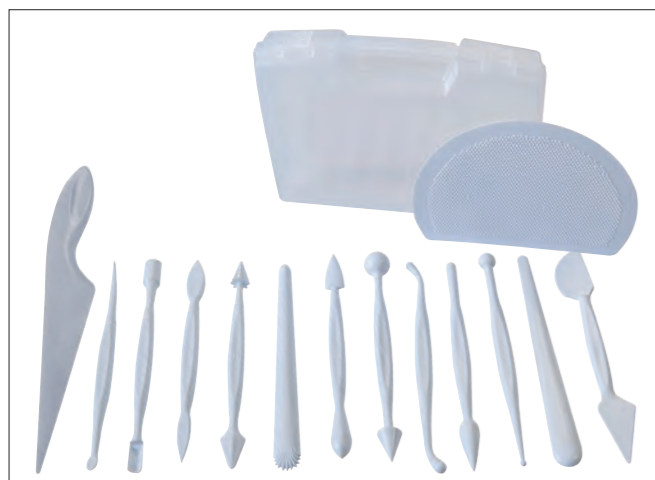

Tool kit A

14 pcs

Kit composed of: 12 assorted double-tipped tools + 1 knife + 1 scraper.

Kit composto da: 12 strumenti a doppia punta + 1 coltello + 1 raschietto.

50WA004B

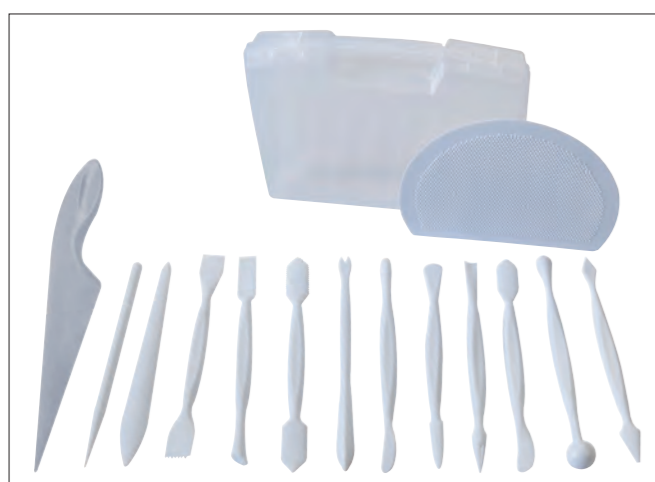

Tool kit B

14 pcs

Kit composed of: 12 assorted double-tipped tools + 1 knife + 1 scraper.

Kit composto da: 12 strumenti a doppia punta + 1 coltello + 1 raschietto.

50WA005B



Smoother

Paletta per lisciare

40-W004



Sugar gun

Allows you to create, in sugar paste, cords, hair, laces and much more.

The pack contains 20 interchangeable discs to create different designs and textures.

Consente di creare, in pasta di zucchero, cordoncini, capelli, lacci e tanto altro.

La confezione contiene 20 dischetti intercambiabili per creare diversi design e trame.

40-WA007

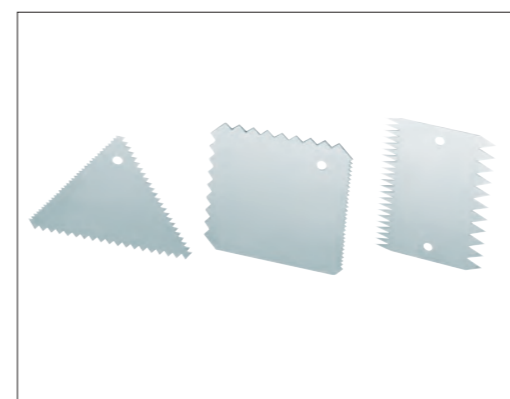

Inox combs

St. steel decorative combs set - thickness 0,5 mm

Kit pettini decorativi in acciaio - spessore 0,5 mm

Triangular/Triangolo 100 x 103 mm

Square/Quadrato 100 x 100 mm

Rectangular/Rettangolo 56 x 110 mm

INOX 3

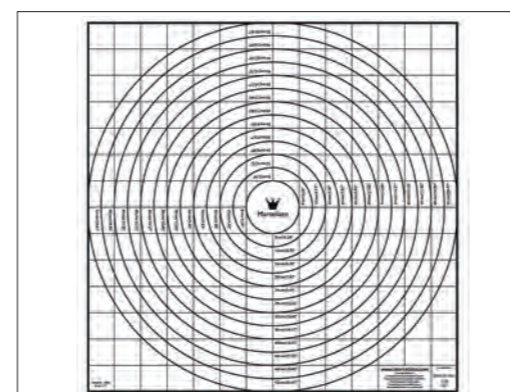

Deco mat 1

Plastic mat for dough rolling out
Tappeto stendipasta in plastica

With non-slip rubber coating.
Con gommatura antiscivolo.

60 x 58 cm

40-W167

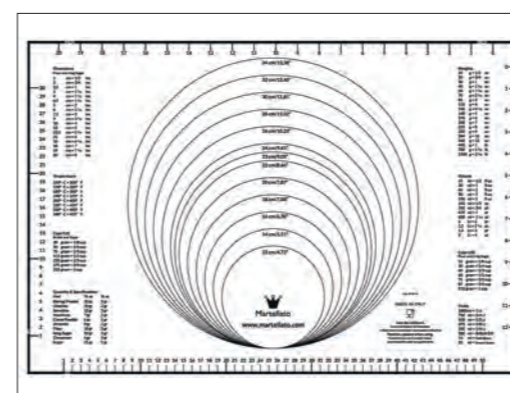

Deco mat 2

Plastic mat for dough rolling out
Tappeto stendipasta in plastica

With non-slip rubber coating.
Con gommatura antiscivolo.

60 x 40 cm

40-W141

AIRBRUSHING/AEROGRAFIA

Everything you need for professional airbrushing: portable compressors and airbrush pens. Portable compressors atomise food colouring through one of our airbrushes. Correct atomisation of the food colouring is guaranteed by the Teflon piston without lubricating oil, which greatly reduces the maintenance required, while the flow regulator keeps the operating pressure constant. Airbrush connection cable included. Professional airbrush pens are designed for colouring chocolate, cakes and moulds. Thanks to its gravity feed, it ensures efficient dye flow and easy cleaning.

Tutto il necessario per l'aerografia professionale: compressori portatili e penne aerografo. I compressori portatili nebulizzano colorante alimentare attraverso uno dei nostri aerografi. La corretta nebulizzazione del colorante alimentare è garantita dal pistone in teflon senza olio di lubrificazione, che riduce di molto la manutenzione necessaria, mentre il regolatore di flusso mantiene la pressione di esercizio sempre costante. Cavo di collegamento per l'aerografo incluso. Le penne aerografo professionali sono ideate per colorare cioccolato, dolci e stampi. Grazie alla sua alimentazione per gravità, garantisce un flusso di colorante efficiente ed una pulizia facile.



Airbrush compressor - 4 BAR
Compressore per aerografo - 4 BAR

Air output/Volume aria: 23-25 lt/min.
Power/Potenza: 1/5 HP
Voltage/Voltaggio: 220-240V 50Hz (or 120V/60Hz or 220V/60Hz).
Max pressure/pressione max: 6,5 BAR/95PSI

DECOMP7



Airbrush compressor - 6 BAR
Compressore per aerografo - 6 BAR

Air output/Volume aria: 30-35 lt/min.
Power/Potenza: 1/3 HP
Voltage/Voltaggio: 220-240V 50Hz (or 120V/60Hz or 220V/60Hz).
Max pressure/pressione max: 6,5 BAR/95PSI

DECOMP9



Dual-action airbrush
Aerografo dual-action

Dual-action flow regulator.
Nozzle \varnothing 0,3 mm.
Capacity 7 cc.
Regolatore di flusso a doppia azione.
 \varnothing ugello 0,3 mm.
Capacità 7 cc.

DECOAIR 2



Single-action airbrush
Aerografo single-action

Single-action flow regulator.
Nozzle \varnothing 0,3 mm.
With 3 tanks: 2, 5 e 13 cc.
Regolatore di flusso ad azione singola.
 \varnothing ugello 0,3 mm.
Con 3 serbatoi da 2, 5 e 13 cc.

DECOAIR 6



Airbrush and mini compressor
Aerografo e mini compressore

Kit for small decorations that includes: double action airbrush pen (nozzle \varnothing 0,2 mm), mini 1.5 BAR compressor, airbrush holder and travel case.

Kit per piccole decorazione che comprende: penna aerografo a doppia azione (\varnothing ugello 0,2 mm), mini compressore da 1,5 BAR, supporto per l'aeropenna e trousse da viaggio.

DECOCP02



ARTISTIC SUGAR/ZUCCHERO ARTISTICO



Sugarlamp

Designed for sugar processing, Made in varnished metal and brushed steel.
Height and tilt adjustment of the lamp body.
2-level power control: 600- 1200W.
Work surface: 625 x 450 mm - complete with electric cable.
*Ideata per la lavorazione dello zucchero, Realizzata in metallo verniciato e acciaio spazzolato.
Regolazione del corpo lampada in altezza ed in inclinazione. Controllo della potenza su 2 livelli: 600- 1200W.
Piano di lavoro: 625 x 450 mm - completa di cablaggio elettrico.*

LAMP01



Caramellometer

With cage.
Caramellometro con gabbia

Temp. min 80°C
Temp. max 200°C.
h 30 cm

MTE



Sugar pomp

Pompetta per zucchero

POMP

TRANSPORT & STORAGE



EASY COVERS

Easy Covers is the most complete system for storing your products thanks to trays and lids made of high quality BPA free plastic material. Ultra-light and easy to transport, unbreakable, non-deformable and with high elasticity, they resist to shocks even at very low temperatures. The transparent and opalescent surface protects from light and allows you to see the product inside, making the trays with lids of the Easy Covers line very versatile. Made in Italy.

Easy Covers è il sistema più completo per conservare i tuoi prodotti grazie a vassoi e coperchi realizzati in materiale plastico di alta qualità BPA free. Ultra leggeri e facili da trasportare, infrangibili, indeformabili e con elevata elasticità, resistono agli urti anche a bassissime temperature. La superficie trasparente e opalescente protegge dalla luce e consente di vedere il prodotto all'interno, rendendo i vassoi con coperchi della linea Easy Covers molto versatili. Made in Italy.

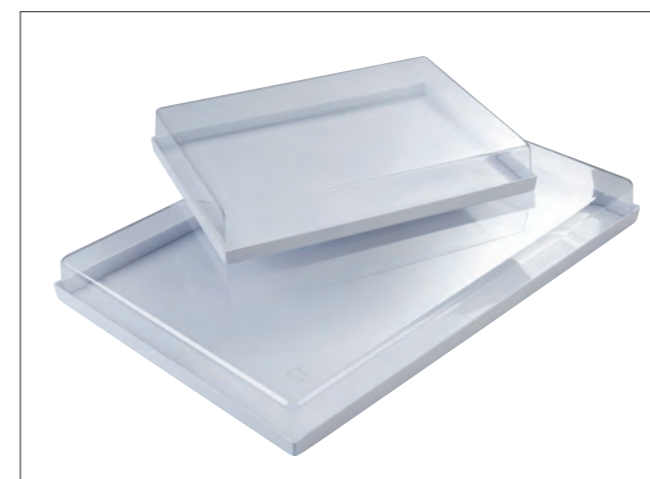

Easy Covers kit

Tray and lid kit
Kit vassoio e coperchio

Cod.	Size
VC30X40	30 x 40 h 6,2 cm
VC60X40	59,5 x 39,5 h 6,2 cm
VC60X404	59,5 x 39,5 h 4,2 cm
VC60X408	59,5 x 39,5 h 8,2 cm



Easy Covers trays

Vassoi

Cod.	Size
VASSOIOAMI	39,5 x 20 h 2 cm
VASSOIOAMO	39,5 x 17,3 h 2 cm
VASSOIOBMI	39,5 x 29,8 h 2 cm
VASSOIOBMO	39,5 x 25,8 h 2 cm
VASSOIOCFMI	59 x 39,6 h 2,5 cm
VASSOIOCFMO	59,8 x 39,6 h 2 cm

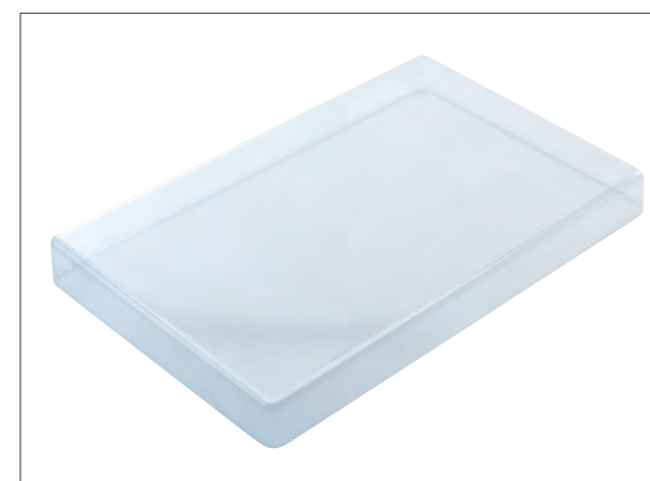

Easy Covers lids

Coperchi

Cod.	Size
COVER 3	59 x 39 h 6 cm
COVER 3H4	59 x 39 h 4 cm
COVER 3H45	59 x 39 h 4,5 cm
COVER 4	30 x 40 h 6 cm
COVER 8	59 x 39 h 8 cm
COVER3H48	59 x 39 h 4,8 cm



MULTIPURPOSE BOARDS/TAVOLE MULTIFUNZIONE

Multifunctional boards made of extremely resistant plastic material, suitable for moving and storing cakes and other products. Absorbs neither odour nor moisture. Other sizes and shapes available on request.

Tavole multifunzione in materiale plastico estremamente resistente, adatte allo spostamento e stoccaggio di torte ed altri prodotti. Non assorbe nè odori, né umidità. Altre misure e forme realizzabili su richiesta.



Rectangular board suitable for insertion in transportation boxes. Thickness 8 mm.
Tavola rettangolare adatta ad essere inserita nelle casse per il trasporto. Spessore 8 mm.

Cod.	Size
TAV 59X39	590 x 390 x h 8 mm

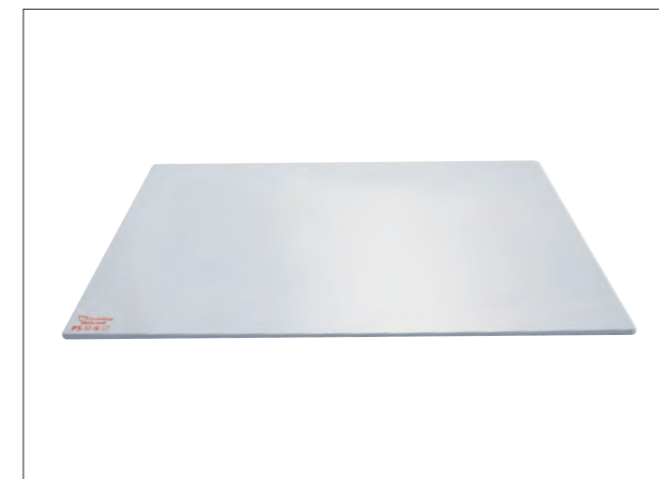

Rectangular board suitable for insertion in the rails of blast chillers and fridge. Thickness 8 mm.
Tavola rettangolare adatta ad essere inserita nelle guide di abbattitori e conservatori. Spessore 8 mm.

Cod.	Size
TAV60X40	400 x 600 x h 8 mm

PLASTIC CASE/CASSE IN PLASTICA



Case with closed bottom - without handles
Cassa con fondo chiuso - senza maniglie

Cod.	Size	Cap.
50CA604007C	60 x 40 h 7 cm	12 lt
50CA604010C	60 x 40 h 10 cm	18 lt
50CA604013C	60 x 40 h 13 cm	24 lt



Lid for 60x40 case
Coperchio per casse 60x40

Cod.	Size
50CA6040COP	60 x 40 cm

TROLLEYS COVER/COPERTURA CARRELLI



Disposable cover for trolleys
Copertura monouso per carrelli

Disposable cover for whole trolleys with pans up to Gastronorm size 2/1. The rolls of 200 pieces 180 cm high are made of plastic with 20 micron thickness.

Copertura monouso per carrelli interi con teglie fino alla dimensione Gastronorm 2/1. I rotoli da 200 pezzi alti 180 cm sono in plastica con spessore 20 micron.

50CP01

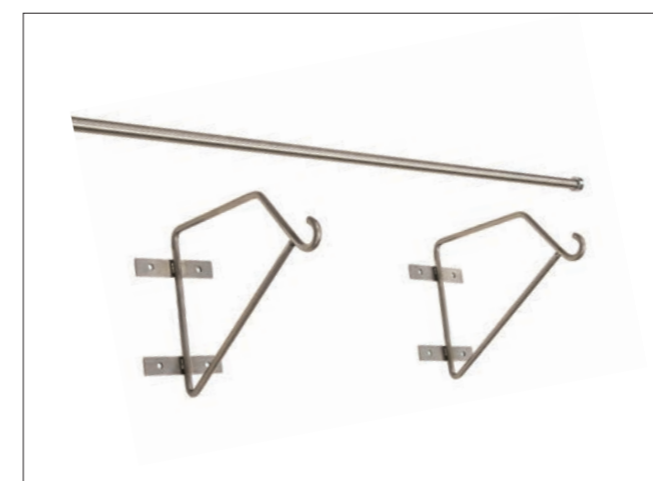

Wall roll holder bracket
Staffa porta rotolo da muro

Stainless steel wall roll holder bracket for plastic covers code 50CP01.

Staffa porta rotolo da muro in acciaio inox per coperture in plastica cod. 50CP01.

50ST01

BANQUETING

CUPS



ELEGANT

Catering Solution

FOR YOUR BEST CREATIONS

Design and quality define the elegant small glasses and cups ideal for every professional in the Ho.Re.Ca., Pastry and Ice-cream sector. The products in the Elegant Catering Solution line are made by Martellato from a high quality material that gives not only strength but also shine and transparency.

We offer a wide choice of models to satisfy various aesthetic tastes and different requirements, also available in different capacities and sizes.

Design e qualità definiscono gli eleganti bicchierini e coppette ideali per ogni professionista del settore Ho.Re.Ca., della Pasticceria e Gelateria.

I prodotti della linea Elegant Catering Solution sono realizzati da Martellato con un materiale di alta qualità che conferisce, oltre alla resistenza, anche lucidità e trasparenza. Offriamo una vasta scelta di modelli per soddisfare vari gusti estetici e differenti esigenze, disponibili anche in diverse capacità e misure.



REUSABLE

RIUTILIZZABILI

RECYCLABLE

RICICLABILI

RESISTANT

RESISTENTI

BPA FREE





Slice

Cap. 160 ml
135 x 69 h 42 mm
Pack 100 pcs

PMOFT001



Bucket

Cap. 210 ml
ø 78 h 57 mm
Pack 100 pcs

PMOTO005



Lid

Pack 100 pcs

PMOFT001C



Cutter

Pack 1pc

31CUT04



Lid

Pack 100 pcs

PMOTO005/C



Cutter

Pack 1 pc

31CUT03



Eclair

120 ml
137 x 37 h 41 mm
Pack 100 pcs

PMOCL001



Lid

Pack 100 pcs
PMOCL001C



Cutter

Pack 1 pc
31CUT01



Eclair XL

Cap. 165 ml
144 x 43 h 48 mm
Pack 100 pcs

PMOCL002



Lid

Pack 100 pcs
PMOCL002C



Cutter

Pack 1pc
31CUT01



Cubò

Cap. 58 ml
50 x 50 h 55 mm
Pack 100 pcs

PMOCU004



Lid

Pack 100 pcs

PMOCU002/C



Triangle

Cap. 175 ml
ø 81 x 83 h 65 mm
Pack 100 pcs

PMO07.00



Lid

Pack 100 pcs

PMO07/C



Heart

Cap. 100 ml
73 x 64 h 52 mm
Pack 100 pcs

PMOLO001



Lid

Pack 100 pcs

PMOLO001/C



Square 1

Cap. 60 ml
40 x 40 h 55 mm
Pack 100 pcs

PMOCU001



Square 2

Cap. 120 ml
50 x 50 h 70 mm
Pack 100 pcs

PMOCU002



Lid

Pack 100 pcs

PMOCU002/C

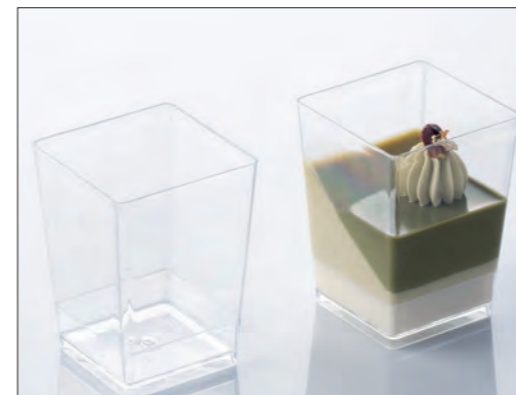

Square 3

Cap. 175 ml
55 x 55 h 80 mm
Pack 100 pcs

PMOCU003



Lid

Pack 100 pcs

PMOCU003/C



Classic 1

Cap. 65 ml
 ø 42 h 65 mm
 Pack 100 pcs

PMOTO001



Classic 2

Cap. 90 ml
 ø 50 h 65 mm
 Pack 100 pcs

PMOTO002



Classic 3

Cap. 120 ml
 ø 55 h 70 mm
 Pack 100 pcs

PMOTO003



Classic 4

Cap. 170 ml
 ø 60 h 90 mm
 Pack 100 pcs

PMOTO004





Tube

Cap. 80 ml
 ø 40 h 85 mm
 Pack 100 pcs

PMO08.00



Penta

Cap. 120 ml
 68 x 56 h 56 mm
 Pack 100 pcs

PMOPE001



Waffle

Cap. 70 ml
 64 x 62 h 59 mm
 Pack 100 pcs

PMOCO013



Soft Ice

Cap. 105 ml
 ø 70 h 59 mm
 Pack 100 pcs

PMOCO014





Bubble

Cap. 215 ml
 ø 90 h 75 mm
 Pack 100 pcs

PMOCO004



Cone

Cap. 165 ml
 ø 90 h 75 mm
 Pack 100 pcs

PMOCO005

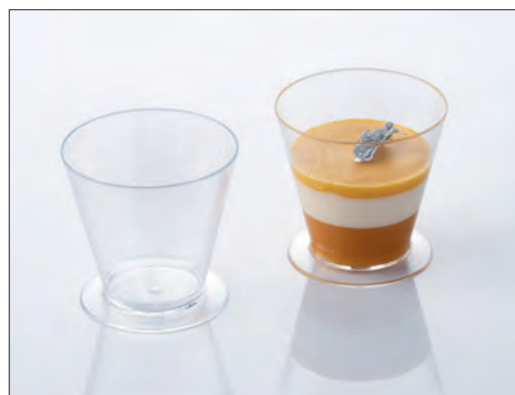

Cup 1

Cap. 90 ml
 ø 65 h 55 mm
 Pack 100 pcs

PMOCO001

Cup 2

Cap. 135 ml
 ø 70 h 67 mm
 Pack 100 pcs

PMOCO002

Cup 3

Cap. 150 ml
 ø 75 h 73 mm
 Pack 100 pcs

PMOCO003



Cylinder

Cap. 190 ml
 ø 65 h 85 mm
 Pack 100 pcs

PMOCO007



Greek 1

Cap. 50 ml
50 x 48 h 57 mm
Pack 100 pcs

PMOCO008

Greek 2

Cap. 120 ml
73 x 71 h 61 mm
Pack 100 pcs

PMOCO009

Greek 3

Cap. 190 ml
92 x 90 h 75 mm
Pack 100 pcs

PMOCO010



Wave 1

Cap. 50 ml
64 x 46 h 53 mm
Pack 100 pcs

PMOCE001

Wave 2

Cap. 120 ml
85 x 60 h 70 mm
Pack 100 pcs

PMOCE002

Wave 3

Cap. 200 ml
100 x 70 h 83 mm
Pack 100 pcs

PMOCE003



Vela 1

Cap. 85 ml
63 x 69 h 57 mm
Pack 100 pcs

PMOCO011



Japan 1

Cap. 47 ml
ø 42 h 43 mm
Pack 100 pcs

PMOJA001



Vela 2

Cap. 140 ml
73 x 81 h 67 mm
Pack 100 pcs

PMOCO012



Japan 2

Cap. 87 ml
ø 50 h 54 mm
Pack 100 pcs

PMOJA002



Vela 3

Cap. 200 ml
90 x 83 h 74 mm
Pack 100 pcs

PMOCO015



Drop

Cap. 190 ml
ø 75 h 85 mm
Pack 100 pcs

PMOCO006

MINI PLATES





Bowl

Transparent
 ø 75,5 x 35 mm
 Pack 100 pcs

PMOVA003.00



Wing

Transparent
 105 x 50 h 30 mm
 Pack 100 pcs

PMO12.00



Triangle

Transparent
 90 x 90 h 15 mm
 Pack 100 pcs

PMO09.00



Mini Bowl 1

Transparent
 75 x 75 h 30 mm
 Pack 100 pcs

PMO11.00



Mini Bowl 2

White
 75 x 75 h 30 mm
 Pack 100 pcs

PMO11.01



Mini Bowl 3

Black
 75 x 75 h 30 mm
 Pack 100 pcs

PMO11.02



Single

Transparent
 65 x 65 h 15 mm
 Pack 100 pcs

PMO13.00



Double

Transparent
 110 x 65 h 20 mm
 Pack 100 pcs

PMO14.00



Blow 1

Transparent
 85 x 85 h 30 mm
 Pack 100 pcs

PMO10.00



Blow 2

Black
 85 x 85 h 30 mm
 Pack 100 pcs

PMO10.02

MONOPORTION PLATES



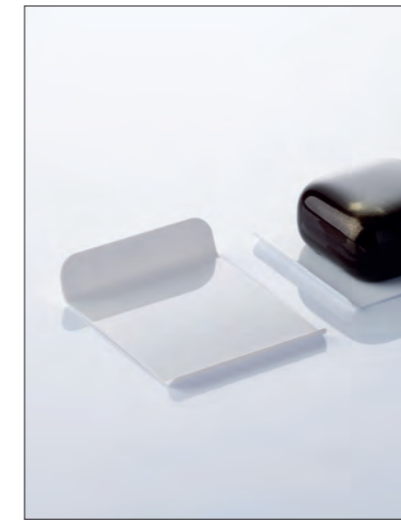

Quadro 1

Transparent
97 x 80 h 20 mm
Pack 100 pcs

PL00200

Quadro 2

White
97 x 80 h 20 mm
Pack 100 pcs

PL00201

Quadro 3

Black
97 x 80 h 20 mm
Pack 100 pcs

PL00202



Tondo 1

Transparent
96 x 86 h 20 mm
Pack 100 pcs

PL00100

Tondo 2

White
96 x 86 h 20 mm
Pack 100 pcs

PL00101

Tondo 3

Black
96 x 86 h 20 mm
Pack 100 pcs

PL00102



Rettangolo 1

Transparent
140 x 60 h 21 mm
Pack 100 pcs

PL00300

Rettangolo 2

White
140 x 60 h 21 mm
Pack 100 pcs

PL00301

Rettangolo 3

Black
140 x 60 h 21 mm
Pack 100 pcs

PL00302

ZEN TRAYS & BOWLS





Zen Bowl

Transparent - Cap. 410 ml
100 x 118 h 70 mm
Pack 50 pcs

ZENBO00



Zen Bowl

White - Cap. 410 ml
100 x 118 h 70 mm
Pack 50 pcs

ZENBO01



Zen tray

Transparent
110 x 245 h 18 mm
Pack 50 pcs

ZENTR00



Zen tray

White
110 x 245 h 18 mm
Pack 50 pcs

ZENTR01



Zen tray

Black
110 x 245 h 18 mm
Pack 50 pcs

ZENTR02



Zen Bowl

Black - Cap. 410 ml
100 x 118 h 70 mm
Pack 50 pcs

ZENBO02



Zen Cover and tray

It can be used as cover for bowls ZENBO.
Può essere usato anche come coperchio per le bowl ZENBO.

Transparent
100 x 118 h 6 mm
Pack 50 pcs

ZENBO00C

BANQUETING DISPLAYS





Fold single

2 shelves/piani

33 x 34 h 18 cm

Shelves/piani: 17 x 33 cm

80D0900



Fold double

2 shelves/piani

65 x 34 h 18 cm

Shelves/piani: 17 x 65 cm

80D1000





Stairway

4 shelves/piani

Shelves/piani: 35 x 35 h 26 cm - 30 x 30 h 21 cm -
25 x 25 h 16 cm - 20 x 20 h 12 cm

80D1900

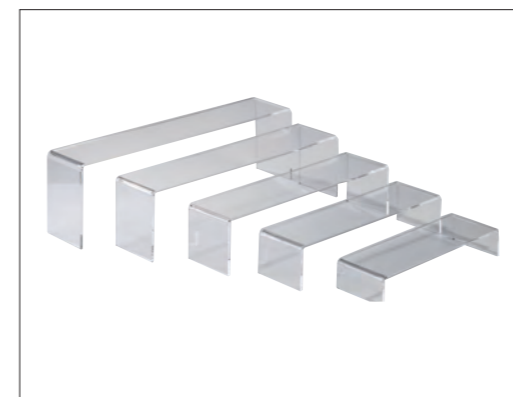

Levels

5 shelves/piani

Shelves/piani: 50 x 10 h 15 cm - 45 x 10 h 12,5 cm -
40 x 10 h 10 cm - 35 x 10 h 7,5 cm - 30 x 10 h 5 cm

80D2000



Mosaic 4

ø 24 h 4,5 cm

80D0600



Mosaic 8

ø 24 h 8,5 cm

80D0700



Mosaic 12

ø 24 h 12,5 cm

80D0800



Mosaic kit

kit 3 displays

ø 24 h 4,5 - h 8,5 - h 12,5 cm

80D0500



Cross small

25 x 25 h 14 cm

80D0200



Cross big

30 x 30 h 19 cm

80D0300



Cross double

20 x 50 h 14 cm

80D0400



Cross kit

kit 3 displays

25 x 25 h 14 cm - 30 x 30 h 19 cm - 50 x 20 h 14 cm

80D0100



5 Rounds

5 shelves/piani

ø 50 x h 58 cm

Misure piatti: ø 50 - 42 - 34 - 26 - 18 cm

COD. 603



4 Squares

4 shelves/piani

49 x 49 x h 41 cm

Misure piatti: 49 x 49 - 39 x 39 - 29 x 29 - 19 x 19 cm

Distanza fra piani: 12 cm

COD60501



Drop

4 shelves/piani

40 x 27 h 29 cm - 40 x 27 h 21 cm - 40 x 27 h 13 cm -

40 x 27 h 5 cm

COD. 307

CAKE STANDS





Plexiglass cake stands.
Alzate per torte in plexiglass.



Loop 5

ø 77 h 26 cm
Shelves/piani: ø 26 cm
Columns/colonne:
1 pc h 10 cm
2 pcs h 18 cm
2 pcs h 26 cm

80A1400



Loop 3

ø 65 h 26 cm
Shelves/piani: ø 26 cm
Columns/colonne:
1 pc h 10 cm
1 pc h 18 cm
1 pc h 26 cm

80A1500



Demi Loop

65 x 45,5 h 35 cm
Shelves/piani: ø 26 cm
Columns/colonne:
1 pc h 10 cm
1 pc h 22 cm
1 pc h 35 cm

80A1600

Infinity

Large cake stand made entirely of plexiglass, configurable in 3, 5 or 7 shelves to meet different display needs. There are 18 small columns to be manually screwed into the bottom of the shelves that will easily sink inside the cakes.

Alzata per torte di grandi dimensioni realizzata completamente in plexiglass, configurabile in 3, 5 o 7 ripiani per soddisfare diverse esigenze di esposizione. Sono presenti 18 colonnine da avvitare manualmente sul fondo dei ripiani che affonderanno con facilità all'interno delle torte.

7 shelves/piani

ø 40 h 69 cm
Shelves/piani: ø 16 - 20 - 24 - 28 - 32 - 36 - 40 cm
Columns/colonne: 18 h 10 cm

80A1300

Replacement columns for Infinity cake stand/Colonnine di ricambio per alzata Infinity
pack 3 pcs

80RIC1300

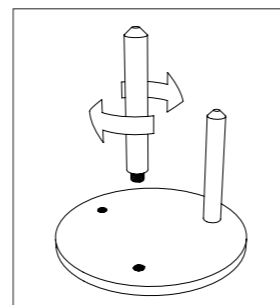



Elegant

Modular cake stand/alzata modulabile

h 153 cm

Shelves/piani: ø 20 - 23,5 - 26,5 - 30 - 34 - 38 cm.

Distance between shelves/distanza tra piani: 16,5 cm

80A1900



Romantic

h 125 cm

Shelves/piani: ø 20 - 22 - 26 - 28 - 30 cm

COD. 504



Plexiglass cake stands.
Alzate per torte in plexiglass.



Baroque Small

transparent
ø 26 h 21 cm

80A0900



Baroque Big

transparent
ø 26 h 35 cm

80A1000



Baroque kit

transparent
5 cake stands/alzate
1 x ø 26 h 35 cm
4 x ø 26 h 21 cm

80A1100



Baroque Small

black
ø 26 h 21 cm

80A0908



Baroque Big

black
ø 26 h 35 cm

80A1008



Baroque kit

black
5 cake stands/alzate
1 x ø 26 h 35 cm
4 x ø 26 h 21 cm

80A1108

MODULAR CAKE DISPLAYS



Modular 3

67 x 37 h 21 cm
Shelves/piani: ø 32 - 26 - 20 cm

COD512



Modular 5

100 x 53 h 39,5 cm
Shelves/piani: ø 32 - 26 - 20 cm

COD514



Modular 4

70 x 65 h 56 cm
Shelves/piani: ø 38 - 32 - 26 - 20 cm

COD513

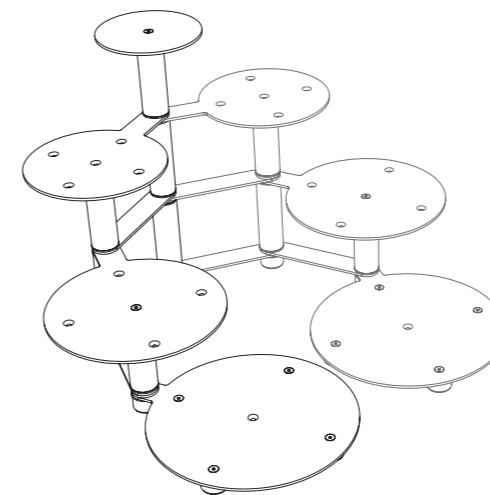

COD513 + COD513

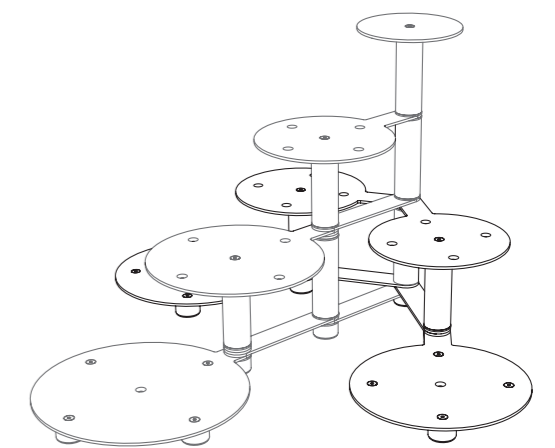

COD513 + COD514

By combining the stands you will have further compositions.
Combinando tra loro le alzate si possono avere ulteriori combinazioni.

LITTLE WEDDING CAKES



Plastic dummies Tamburi per torta

Cod.	Size	
40-W106	ø 50 - 40 - 30 - 20 cm	kit 4 pcs
40-W110	ø 20 h 10 cm	
40-W111	ø 30 h 10 cm	
40-W112	ø 40 h 10 cm	
40-W113	ø 50 h 10 cm	



St. steel Rings Cerchi inox

Cod.	Size
40-W087	ø 19,5 h 5 cm
40-W088	ø 29,5 h 5 cm
40-W089	ø 39,5 h 5 cm
40-W090	ø 49,5 h 5 cm



Non-slip plate Piatto antiscivolo

ø 58 cm

40-W124

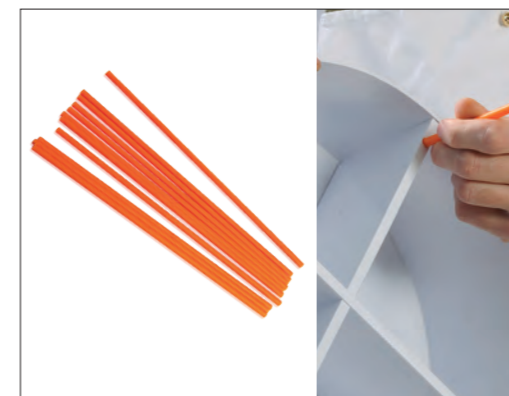

Cake dowel rods Pioli per torta

ø 6 mm
50 pcs

40-W101



Cake dowel rods Pioli per torta

ø 16 x 300 mm
12 pcs

40PI01

CAKE BOARDS/SOTTOTORTA



Cake boards 2 mm Sottotorta 2 mm

honeycomb plastic
plastica alveolata

Cod.	Size	Pack
50ST18	∅ 18 cm	20 pcs
50ST20	∅ 20 cm	20 pcs
50ST22	∅ 22 cm	20 pcs
50ST24	∅ 24 cm	20 pcs
50ST26	∅ 26 cm	20 pcs
50ST28	∅ 28 cm	20 pcs
50ST30	∅ 30 cm	20 pcs
50ST32	∅ 32 cm	20 pcs
50ST40	∅ 40 cm	20 pcs

Cake boards 3 mm Sottotorta 3 mm

hard plastic
plastica rigida

Cod.	Size	Pack
50DI20	∅ 20 cm	3 pcs
50DI22	∅ 22 cm	3 pcs
50DI24	∅ 24 cm	3 pcs
50DI26	∅ 26 cm	3 pcs
50DI28	∅ 28 cm	3 pcs
50DI30	∅ 30 cm	3 pcs
50DI32	∅ 32 cm	3 pcs
50DI34	∅ 34 cm	3 pcs

Cod.	Size	Pack
SET DISK	∅ 20 - 22 - 24 - 26 - 28 - 30 - 32 - 34 cm	8 pcs



Cake boards 8 mm Sottotorta 8 mm

hard plastic
plastica rigida

Other shapes and sizes on request.
Altre dimensioni e forme realizzabili su richiesta.

Round without feet Rotondi senza piedini

Cod.	Size	Feet/Piedini
TAV D. 40 PIA	∅ 40 cm	no
TAV D. 50 PIA	∅ 50 cm	no
TAV D. 60 PIA	∅ 60 cm	no
TAV D. 70 PIA	∅ 70 cm	no
TAV D. 80 PIA	∅ 80 cm	no
TAV D. 90 PIA	∅ 90 cm	no
TAV D.100 PIA	∅ 100 cm	no

Square without feet Quadrati senza piedini

Cod.	Size	Feet/Piedini
TAV 50X50 PIA	50 x 50 cm	no
TAV 60X60 PIA	60 x 60 cm	no
TAV 70X70 PIA	70 x 70 cm	no

Rectangular without feet Rettangolari senza piedini

Cod.	Size	Feet/Piedini
TAV 50X60 PIA	50 x 60 cm	no
TAV 60X70 PIA	60 x 70 cm	no
TAV 60X80 PIA	60 x 80 cm	no

Round with plastic feet ∅ 25 mm Rotondi con piedini ∅ 25 mm

Cod.	Size	Feet/Piedini
TAV D. 40 C/P	∅ 40 cm	5
TAV D. 50 C/P	∅ 50 cm	5
TAV D. 60 C/P	∅ 60 cm	5
TAV D. 70 C/P	∅ 70 cm	9
TAV D. 80 C/P	∅ 80 cm	9
TAV D. 90 C/P	∅ 90 cm	9
TAV D.100 C/P	∅ 100 cm	13

Square with plastic feet ∅ 25 mm Quadrati con piedini ∅ 25 mm

Cod.	Size	Feet/Piedini
TAV 50X50 C/P	50 x 50 cm	4
TAV 60X60 C/P	60 x 60 cm	5
TAV 70X70 C/P	70 x 70 cm	9

Rectangular with plastic feet ∅ 25 mm Rettangolari con piedini ∅ 25 mm

Cod.	Size	Feet/Piedini
TAV 40X60 C/P	40 x 60 cm	5
TAV 50X60 C/P	50 x 60 cm	5
TAV 60X70 C/P	60 x 70 cm	9
TAV 60X80 C/P	60 x 80 cm	12

MACARON DISPLAYS & SHOWCASES





80DM02 and 80DM03 displays are stackable with each other for greater capacity.
 I display 80DM02 e 80DM03 sono tra loro impilabili per una maggiore capienza.



Macaron 24

pack 5 pcs
 ø 180 h 173 mm
 Cap. 24 pcs

80DM01



Macaron 36

ø 247 h 232 mm
 Cap. 36 pcs

80DM02



Macaron 60

ø 247 h 352 mm
 Cap. 60 pcs

80DM03



ø 240 h 280 mm
 Cap. 30 pcs

AG07701P

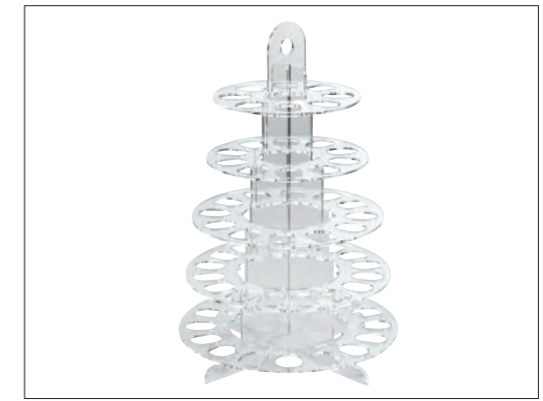

ø 280 h 430 mm
 Cap. 62 pcs

AG07701



350 x 350 h 450 mm
 Cap. 60 pcs

AG07901



315 x 325 h 65 mm
 Cap. 50 pcs

AG05801



270 x 330 h 145 mm
 Cap. 40 pcs

AG05601



460 x 330 h 145 mm
 Cap. 70 pcs

AG05701



Jewel Box Showcase

Complete with tray for displaying brioche and rails for displaying approx. 50 macarons.
 Completa di vassoio per esporre brioche e di guide per esporre circa 50 macaron.

32,5 x 35 h 13 cm

Tray/vassoio: 30 x 32,5 tray
 Rails/guide: 4 x 4 x 32 cm (5 pcs)

AG05820



Plexiglass Showcase

60 x 36 x h 16 cm

VP00101

Accessories for VP00101 on next page.
 Accessori per VP00101 nella pagina seguente.

PLEXIGLASS TRAYS/VASSOI IN PLEXIGLASS



Transparent. Suitable for VP00101 display.
Trasparenti. Adatti alla vetrina VP00101.

Cod.	Size	Type
VP00906	10 x 50 h 2 cm	tray/vassoio
VP01001	9,5 x 49,5 h 0,2 cm	plate/piatto

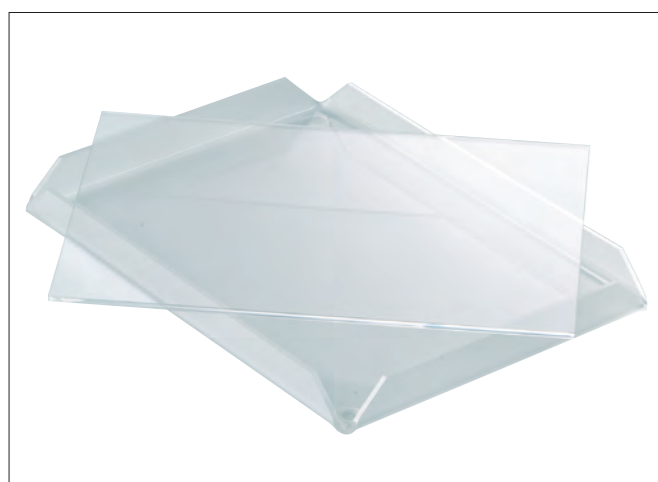

Transparent. Suitable for VP00101 display.
Trasparenti. Adatti alla vetrina VP00101.

Cod.	Size	Type
VP00206	17 x 17 h 2 cm	tray/vassoio
VP00301	16,5 x 16,5 h 0,2 cm	plate/piatto
VP01106	17 x 23 h 2 cm	tray/vassoio
VP01201	16,5 x 22,5 h 0,2 cm	plate/piatto

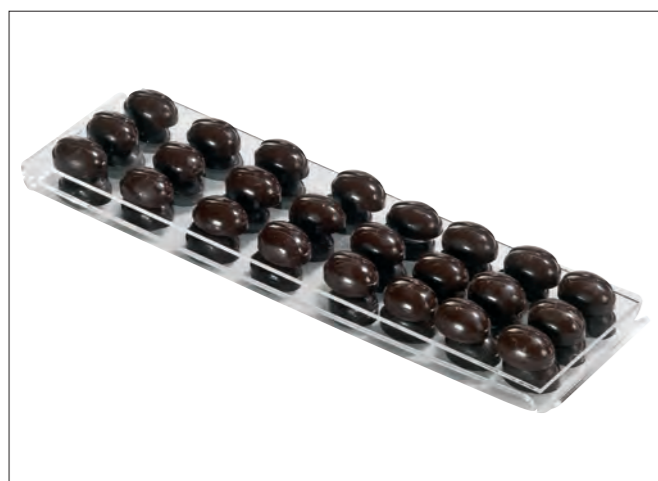

Transparent. Suitable for VP00101 display.
Trasparenti. Adatti alla vetrina VP00101.

Cod.	Size	Type
VP00401	34 x 11 h 2 cm	tray/vassoio
VP00501	32 x 9 h 0,2 cm	plate/piatto



Ideal for croissants. Bianco opalino.
Ideali per brioche. Opal white.

Cod.	Size
51VP024510	45 x 10 h 2,5 cm
51VP024515	45 x 15 h 2,5 cm
51VP024525	45 x 25 h 2,5 cm
51VP026010	60 x 10 h 2,5 cm
51VP026015	60 x 15 h 2,5 cm
51VP026025	60 x 25 h 2,5 cm



Ideal for monoportion, mignon, pralines.
Bianco opalino.
Ideali per monoporzioni, mignon, praline.
Opal white.

Cod.	Size
51VP014510	45 x 10 cm
51VP014515	45 x 15 cm
51VP014525	45 x 25 cm
51VP016010	60 x 10 cm
51VP016015	60 x 15 cm
51VP016025	60 x 25 cm

PLEXIGLASS SHOWCASES/VETRINE IN PLEXIGLASS



Showcase with door Vetrina con porta

3 inclined shelves/ripiani inclinati

42 x 31 h 42,5 cm

Cod.	Colour
VB00201	Transparent/Trasparente
VB00208	Black/Nero



LED showcase with door Vetrina a LED con porta

3 inclined shelves/ripiani inclinati

39,5 x 32,5 h 50,5 cm

VB00308



Showcase with door Vetrina con porta

3 inclined shelves/ripiani inclinati

37 x 31 h 31 cm

VB00408



Food shield Proteggi brioche

Customizable sizes on request.
Misure personalizzabili su richiesta.

Cod.	Size
AR0001	49,5 x 30 h 27 cm
AR00011	99,5 x 30 h 27 cm

FOOD COLOURS

Colour Cocoa Butter



Colored cocoa butter, ideal for coloring and decorating chocolate and fatty masses. Usage tips: Temper the cocoa butter before each use.

Burro di cacao colorato, ideale per la colorazione e decorazione di cioccolato e masse grasse. Temperare il burro di cacao prima di ogni utilizzo.



Colour	Cod.	Size	Azo	Azo Free	Gluten Free	Vegan	FDA
 Black	40LCB006	200 g	✓	-	✓	-	✓
	40WCB006	30 g	✓	-	✓	-	✓
 Blue	40LCB002	200 g	-	✓	✓	✓	-
	40WCB002	30 g	-	✓	✓	✓	-
 Green	40LCB009	200 g	✓	-	✓	✓	✓
	40WCB009	30 g	✓	-	✓	✓	✓
 Orange	40LCB001	200 g	✓	-	✓	✓	✓
	40WCB001	30 g	✓	-	✓	✓	✓
 Red	40LCB008	200 g	✓	-	✓	-	✓
	40WCB008	30 g	✓	-	✓	-	✓
 White	40LCB000	200 g	-	✓	✓	✓	✓
	40WCB000	30 g	-	✓	✓	✓	✓
 Yellow	40LCB004	200 g	✓	-	✓	✓	✓
	40WCB004	30 g	✓	-	✓	✓	✓

New size







Pearl Cocoa Butter



Pearlescent cocoa butter, ideal for coloring and decorating chocolate and fatty masses. Usage tips: Temper the cocoa butter before each use.

Burro di cacao perlato, ideale per la colorazione e decorazione di cioccolato e masse grasse. Temperare il burro di cacao prima di ogni utilizzo.

Colour	Cod.	Size	Azo	Azo Free	Gluten Free	Vegan	FDA
 Pearl gold	40LCB017	200 g	-	✓	✓	✓	-
	40WCB017	30 g	-	✓	✓	✓	-
 Pearl silver	40LCB019	200 g	-	✓	✓	✓	-
	40WCB019	30 g	-	✓	✓	✓	-
 Pearl bronze New	40LCB015	200 g	-	✓	✓	✓	-
 Pearl copper New	40LCB020	200 g	-	✓	✓	✓	-

The colours shown are indicative. The intensity of the colour obtained may vary depending on the type of surface or mass being coloured, the amount of dye used and the conditions under which it is used. I colori rappresentati sono indicativi. L'intensità del colore ottenuto può variare in base al tipo di superficie o massa che si colora, alla quantità di colorante utilizzato e alle condizioni di utilizzo dello stesso.

Colour Gel



WATER-SOLUBLE

Concentrated water-soluble gel dye. Ideal for mass decoration of all water-based or emulsion-based products such as fondant, cream, glazes, cookies, and meringues.

Colorante in gel idrosolubile concentrato. Ideale per la decorazione in massa di tutti i prodotti a base acqua o emulsioni come pasta di zucchero, panna, glasse e impasti vari come biscotti e meringhe.



Colour	Cod.	Size	Azo	Azo Free	Gluten Free	Vegan	FDA
 Black	40LCG006	30 g	✓	-	✓	✓	-
 Blue	40LCG002	30 g	-	✓	✓	✓	-
 Brown	40LCG005	30 g	✓	-	✓	✓	-
 Green	40LCG009	30 g	✓	-	✓	✓	-
 Lime Green	40LCG016	30 g	✓	-	✓	✓	-
 Orange	40LCG001	30 g	✓	-	✓	✓	-
 Pink	40LCG007	30 g	✓	-	✓	✓	-
 Purple	40LCG010	30 g	✓	-	✓	✓	-
 Red	40LCG008	30 g	✓	-	✓	✓	-
 Turquoise	40LCG026	30 g	✓	-	✓	✓	✓
 Yellow	40LCG004	30 g	✓	-	✓	✓	-



The colours shown are indicative. The intensity of the colour obtained may vary depending on the type of surface or mass being coloured, the amount of dye used and the conditions under which it is used. I colori rappresentati sono indicativi. L'intensità del colore ottenuto può variare in base al tipo di superficie o massa che si colora, alla quantità di colorante utilizzato e alle condizioni di utilizzo dello stesso.



Colour Liquid













WATER-SOLUBLE



Ready-to-use water-soluble liquid dye. Suitable for use with an airbrush. Also ideal for mass coloring of sponge cake, cream, gelatin, almond paste, marzipan, and beverages.

Colorante liquido idrosolubile pronto all'uso. Idoneo all'uso con l'aerografo. Ideale anche per la colorazione in massa di pan di spagna, panna, crema, gelatina, pasta di mandorle, marzapane e bevande in genere.



Colour	Cod.	Size	Azo	Azo Free	Gluten Free	Vegan	FDA
 Azure	40LCA003	190 ml	-	✓	✓	✓	-
 Black	40LCA006	190 ml	✓	-	✓	✓	-
 Blue	40LCA002	190 ml	-	✓	✓	✓	-
 Brown	40LCA005	190 ml	✓	-	✓	✓	-
 Green	40LCA009	190 ml	✓	-	✓	✓	-
 Lemon yellow	40LCA011	190 ml	✓	-	✓	✓	-
 Light green	40LCA012	190 ml	✓	-	✓	✓	-
 Orange	40LCA001	190 ml	✓	-	✓	✓	-
 Pink	40LCA007	190 ml	✓	-	✓	✓	-
 Purple	40LCA010	190 ml	✓	-	✓	✓	-
 Red	40LCA008	190 ml	✓	-	✓	✓	-
 Yellow	40LCA004	190 ml	✓	-	✓	✓	-

The colours shown are indicative. The intensity of the colour obtained may vary depending on the type of surface or mass being coloured, the amount of dye used and the conditions under which it is used. I colori rappresentati sono indicativi. L'intensità del colore ottenuto può variare in base al tipo di superficie o massa che si colora, alla quantità di colorante utilizzato e alle condizioni di utilizzo dello stesso.

Colour

E171 FREE







Liquid

LIPOSOLUBLE

Oil-based liposoluble colors. Ideal for mass coloring of chocolate and fatty masses such as buttercream and more.

Colori liposolubile a base di olio. Ideale per la colorazione in massa di cioccolato e masse grasse come crema al burro e altro.



Colour	Cod.	Size	Azo	Azo Free	Gluten Free	Vegan	FDA
 Blue <i>New</i>	40LCL002	190 g	-	✓	✓	✓	-
 Brown <i>New</i>	40LCL005	190 g	✓	-	✓	✓	-
 Green <i>New</i>	40LCL009	190 g	✓	-	✓	✓	-
 Orange <i>New</i>	40LCL001	190 g	✓	-	✓	✓	-
 Pink <i>New</i>	40LCL007	190 g	-	✓	✓	-	✓
 Red <i>New</i>	40LCL008	190 g	✓	-	✓	-	-
 Yellow <i>New</i>	40LCL004	190 g	✓	-	✓	✓	-

Pearl

E171 FREE

Liquid

HYDROALCOHOLIC



Ready-to-use hydroalcoholic liquid dye. Suitable for use with an airbrush. Usage tips: Remove the pigment from the bottom using a toothpick and shake well before use.

Colorante liquido idroalcolico pronto all'uso. Idoneo all'uso con l'aerografo. Consigli d'uso: Rimuovere dal fondo il pigmento aiutandosi con uno stuzzicadenti e agitare bene prima dell'uso.

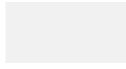
Colour	Cod.	Size	Azo	Azo Free	Gluten Free	Vegan	FDA
 Moon white	40LCA400	100 ml	-	✓	✓	✓	-

The colours shown are indicative. The intensity of the colour obtained may vary depending on the type of surface or mass being coloured, the amount of dye used and the conditions under which it is used. I colori rappresentati sono indicativi. L'intensità del colore ottenuto può variare in base al tipo di superficie o massa che si colora, alla quantità di colorante utilizzato e alle condizioni di utilizzo dello stesso.

Colour Powder











WATER-SOLUBLE

Water-soluble powdered dye ideal for mass coloring of water-based products such as isomalt, sugar, cream, meringues, macarons, and other preparations. Usage tips: Sprinkle the powder on the cold mixture and emulsify using a professional hand blender.

Colorante in polvere idrosolubile ideale per la colorazione in massa di prodotti a base di acqua quali isomalto, zucchero, panna, meringhe, macarons e altre preparazioni. Consigli d'uso: Versare la polvere sul composto freddo ed emulsionare utilizzando un minipimer professionale.



Colour	Cod.	Size	Azo	Azo Free	Gluten Free	Vegan	FDA
 Azure New	40LCP202	25 g	-	✓	✓	✓	-
 Black	40LCP206	25 g	-	✓	✓	✓	-
 Green	40LCP209	25 g	✓	-	✓	✓	✓
 Orange	40LCP211	25 g	✓	-	✓	✓	-
 Pink New	40LCP207	25 g	-	✓	✓	✓	-
 Red	40LCP208	25 g	✓	-	✓	✓	-
 Strawberry red	40LCP218	25 g	✓	-	✓	✓	-
 Turquoise	40LCP226	25 g	✓	-	✓	✓	✓
 Yellow New	40LCP204	25 g	✓	-	✓	✓	-



The colours shown are indicative. The intensity of the colour obtained may vary depending on the type of surface or mass being coloured, the amount of dye used and the conditions under which it is used. I colori rappresentati sono indicativi. L'intensità del colore ottenuto può variare in base al tipo di superficie o massa che si colora, alla quantità di colorante utilizzato e alle condizioni di utilizzo dello stesso.

Colour Powder



LIPOSOLUBLE

Liposoluble powdered dye suitable for mass coloring of fatty products such as cocoa butter, white chocolate, buttercream, almond paste, fondant, and semifreddo. It can be used on the surface with a brush as is, diluted with alcohol, or with liquid shellac, then brushed directly onto the surface to be decorated.

Colorante in polvere liposolubile adatto alla colorazione in massa di prodotti a base grassa quali, burro di cacao, cioccolato bianco, crema al burro, pasta di mandorle, pasta da zucchero, semifreddi. Può essere utilizzato in superficie con un pennello tal quale, diluito con alcol o con la gommalacca liquida per poi essere spennellato direttamente sulla superficie che si desidera decorare.



Colour	Cod.	Size	Azo	Azo Free	Gluten Free	Vegan	FDA
Black	40LCP306	25 g	-	✓	✓	✓	-
	40WC306	5 g	-	✓	✓	✓	-
Blue	40LCP302	25 g	-	✓	✓	✓	-
	40WC302	5 g	-	✓	✓	✓	-
Brown	40LCP305	20 g	✓	-	✓	✓	-
	40WC305	5 g	✓	-	✓	✓	-
Apple green New	40LCP312	25 g	✓	-	✓	✓	✓
	40WC312	5 g	✓	-	✓	✓	✓
Green	40LCP309	25 g	-	✓	✓	✓	-
	40WC309	5 g	-	✓	✓	✓	-
Lemon yellow New	40LCP332	25 g	✓	-	✓	✓	-
	40WC332	5 g	✓	-	✓	✓	-

Colour	Cod.	Size	Azo	Azo Free	Gluten Free	Vegan	FDA
Yellow	40LCP304	25 g	-	✓	✓	✓	-
	40WC304	5 g	-	✓	✓	✓	-
Magenta New	40LCP331	25 g	-	✓	✓	-	✓
	40WC331	5 g	-	✓	✓	-	✓
Orange	40LCP311	25 g	✓	-	✓	✓	-
	40WC311	5 g	✓	-	✓	✓	-
Pink	40LCP307	25 g	-	✓	✓	-	✓
	40WC307	5 g	-	✓	✓	-	✓
Purple New	40LCP310	25 g	✓	-	✓	✓	-
	40WC310	5 g	✓	-	✓	✓	-
Red	40LCP308	25 g	✓	-	✓	✓	-
	40WC308	5 g	✓	-	✓	✓	-
Shock red	40LCP308N	25 g	✓	-	✓	-	-
	40WC308N	5 g	✓	-	✓	-	-
Turquoise	40LCP326	25 g	✓	-	✓	✓	✓
	40WC326	5 g	✓	-	✓	✓	✓
White New size	40LCP300	25 g	-	✓	✓	✓	✓
	40WC300	5 g	-	✓	✓	✓	✓

The colours shown are indicative. The intensity of the colour obtained may vary depending on the type of surface or mass being coloured, the amount of dye used and the conditions under which it is used. I colori rappresentati sono indicativi. L'intensità del colore ottenuto può variare in base al tipo di superficie o massa che si colora, alla quantità di colorante utilizzato e alle condizioni di utilizzo dello stesso.

Pearl Powder



LIPOSOLUBLE

Liposoluble powder colourant with pearl effect, suitable for surface colouring of fat-based products such as white chocolate, buttercream, almond paste, sugar paste, parfaits. It can be used with a brush as is, or diluted with liquid shellac and then brushed directly onto the surface to be decorated.

Colorante in polvere liposolubile effetto perlato, adatto alla colorazione in superficie di prodotti a base grassa quali cioccolato bianco, crema al burro, pasta di mandorle, pasta da zucchero, semifreddi. Può essere utilizzato con un pennello tal quale, o diluito con la gommalacca liquida per poi essere spennellato direttamente sulla superficie che si desidera decorare.



Colour	Cod.	Size	Azo	Azo Free	Gluten Free	Vegan	FDA
	40LCP019	25 g	-	✓	✓	✓	-
	40WC019	5 g	-	✓	✓	✓	-
	40LCP119	25 g	-	✓	✓	✓	-
	40WC119	5 g	-	✓	✓	✓	-
	40LCP015	25 g	-	✓	✓	✓	-
	40WC015	5 g	-	✓	✓	✓	-
	40LCP002	25 g	-	✓	✓	✓	-
	40WC002	5 g	-	✓	✓	✓	-
	40LCP020	25 g	-	✓	✓	✓	-
	40WC020	5 g	-	✓	✓	✓	-
	40LCP017	25 g	-	✓	✓	✓	-
	40WC017	5 g	-	✓	✓	✓	-



Colour	Cod.	Size	Azo	Azo Free	Gluten Free	Vegan	FDA
Pearl green <i>New</i>	40LCP109	25 g	-	✓	✓	✓	-
	40WC109	5 g	-	✓	✓	✓	-
Pearl lime green	40LCP016	25 g	✓	-	✓	✓	-
	40WC016	5 g	✓	-	✓	✓	-
Pearl pink <i>New</i>	40LCP007	25 g	✓	-	✓	✓	-
	40WC007	5 g	✓	-	✓	✓	-
Pearl purple	40LCP010	25 g	-	✓	✓	-	-
	40WC010	5 g	-	✓	✓	-	-
Pearl rose gold <i>New</i>	40LCP023	25 g	-	✓	✓	-	-
	40WC023	5 g	-	✓	✓	-	-
Pearl ruby	40LCP018	25 g	-	✓	✓	✓	-
	40WC018	5 g	-	✓	✓	✓	-

The colours shown are indicative. The intensity of the colour obtained may vary depending on the type of surface or mass being coloured, the amount of dye used and the conditions under which it is used. I colori rappresentati sono indicativi. L'intensità del colore ottenuto può variare in base al tipo di superficie o massa che si colora, alla quantità di colorante utilizzato e alle condizioni di utilizzo dello stesso.

Natural Powder

WATER-SOLUBLE

E171
FREE

Natural water-soluble powdered food dye ideal for decorating and coloring creams, meringues, macarons, glazes, cookies, fondant, and other sweet products.

Colorante alimentare naturale in polvere idrosolubile ideale per la decorazione e colorazione di creme, meringhe, macaron, glasse, biscotti, pasta di zucchero e altri prodotti dolciari.



Colour	Cod.	Size	Azo	Azo Free	Gluten Free	Vegan	FDA
 Azure	40LCPN202	25 g	-	√	√	√	√
 Black	40LCPN206	25 g	-	√	√	√	-
 Green	40LCPN209	25 g	-	√	√	√	-
 Red	40LCPN208	25 g	-	√	√	√	√
 Yellow	40LCPN204	25 g	-	√	√	√	-

Natural Powder







LIPOSOLUBLE

E171
FREE

Natural liposoluble powdered food dye suitable for mass coloring of fatty products such as chocolate, buttercream, almond paste, fondant, and semifreddo.

Colorante alimentare naturale in polvere liposolubile adatto alla colorazione in massa di prodotti a base di grassa quali cioccolato, crema al burro, pasta di mandorle, pasta di zucchero semifreddi.



Colour	Cod.	Size	Azo	Azo Free	Gluten Free	Vegan	FDA
 Azure	40LCPN302	25 g	-	√	√	√	√
 Green	40LCPN309	25 g	-	√	√	√	-
 Pink	40LCPN307	25 g	-	√	√	√	√
 Purple	40LCPN310	25 g	-	√	√	√	√
 Red	40LCPN308	25 g	-	√	√	√	√
 Yellow	40LCPN304	25 g	-	√	√	√	-

The colours shown are indicative. The intensity of the colour obtained may vary depending on the type of surface or mass being coloured, the amount of dye used and the conditions under which it is used. I colori rappresentati sono indicativi. L'intensità del colore ottenuto può variare in base al tipo di superficie o massa che si colora, alla quantità di colorante utilizzato e alle condizioni di utilizzo dello stesso.

Velvet Spray

**E171
FREE**

Cocoa butter-based spray that provides a velvety effect. The product should be sprayed on a cold/frozen surface, e.g., semifreddo, ice cream, mousse, and chocolate. This allows the cocoa butter to crystallize and create the desired velvet effect. Usage tips: Store the canister at a temperature between 20-25°C before use. Spray an even layer of the product from a distance of about 20-25 cm. Clean the dispenser with hot water after each use.

Spray a base di burro di cacao che dona un effetto vellutato. L'articolo deve essere spruzzato su una superficie fredda/congelata. Es. semifreddi, gelati, mousse e cioccolato. In questo modo il burro di cacao cristallizza e crea l'effetto velluto desiderato. Consigli d'uso: Conservare la bomboletta ad una temperatura tra i 20-25°C prima dell'utilizzo. Spruzzare uno strato omogeneo di prodotto ad una distanza di circa 20-25 cm. Pulire l'erogatore con acqua calda al termine di ogni utilizzo.



Colour		Cod.	Size	Azo	Azo Free	Gluten Free	Vegan	FDA
	Azure	40LCV003	400 ml / 308 g	-	√	√	√	-
	Black	40LCV006	400 ml / 308 g	√	-	√	-	√
	Black cherry red	40LCV013	400 ml / 308 g	√	-	√	√	-
	Coral New	40LCV029	400 ml / 308 g	√	-	√	-	√
	Dark Chocolate	40LCV015	400 ml / 308 g	√	-	√	√	-
	Fuchsia	40LCV027	400 ml / 308 g	-	√	√	-	√
	Lavender New	40LCV028	400 ml / 308 g	-	√	√	-	√
	Light green	40LCV009	400 ml / 308 g	-	√	√	√	-
	Lime Green New	40LCV016	400 ml / 308 g	-	√	√	√	√
	Magenta New	40LCV031	400 ml / 308 g	-	√	√	-	-
	Milk Chocolate	40LCV005	400 ml / 308 g	√	-	√	√	-
	Orange	40LCV001	400 ml / 308 g	√	-	√	√	-
	Peach New	40LCV030	400 ml / 308 g	√	-	√	-	√
	Pearl gold New	40LCV017	400 ml / 308 g	-	√	√	√	-
	Pink	40LCV007	400 ml / 308 g	-	√	√	-	√
	Purple	40LCV010	400 ml / 308 g	-	√	√	-	√
	Red	40LCV008	400 ml / 308 g	√	-	√	-	√
	White	40LCV000	400 ml / 308 g	-	√	√	√	√
	White chocolate	40LCV024	400 ml / 308 g	-	√	√	√	-
	Yellow	40LCV004	400 ml / 308 g	-	√	√	√	-

The colours shown are indicative. The intensity of the colour obtained may vary depending on the type of surface or mass being coloured, the amount of dye used and the conditions under which it is used. I colori rappresentati sono indicativi. L'intensità del colore ottenuto può variare in base al tipo di superficie o massa che si colora, alla quantità di colorante utilizzato e alle condizioni di utilizzo dello stesso.

Colour Spray

HYDROALCOHOLIC

Hydroalcoholic colored sprays ideal for decorating the surfaces of cream-based cakes, small chocolate decorations, biscuits, wafers, waffles, and sugar paste-based sweets.

Spray colorati idroalcolici ideali per decorare superfici di torte a base di panna, piccole decorazioni di cioccolato, biscetteria, wafer, cialde e dolci a base di pasta di zucchero.



E171
FREE



Colour	Cod.	Size	Azo	Azo Free	Gluten Free	Vegan	FDA
 Brown	40LCS005	100 ml / 64 g	✓	-	✓	✓	-
 Green	40LCS009	100 ml / 64 g	-	✓	✓	✓	-
 Orange	40LCS001	100 ml / 64 g	✓	-	✓	✓	-
 Pink	40LCS007	100 ml / 64 g	-	✓	✓	-	✓
 Red	40LCS008	100 ml / 64 g	✓	-	✓	✓	-
 White	40LCS000	100 ml / 64 g	-	✓	✓	✓	✓
 Yellow	40LCS004	100 ml / 64 g	✓	-	✓	✓	-

Pearl Spray

HYDROALCOHOLIC

Pearlescent hydroalcoholic sprays ideal for decorating the surfaces of cream-based cakes, biscuits, wafers, waffles, and sugar paste-based sweets.

Spray perlati idroalcolici ideali per decorare superfici di torte a base di panna, biscetteria, wafer, cialde e dolci a base di pasta di zucchero.



E171
FREE



Colour	Cod.	Size	Azo	Azo Free	Gluten Free	Vegan	FDA
 Pearl bronze	40LCS215	100 ml / 64 g	-	✓	✓	✓	-
 Pearl copper	40LCS220	100 ml / 64 g	-	✓	✓	✓	-
 Pearl gold	40LCS217	100 ml / 64 g	-	✓	✓	✓	-
 Pearl mother-of-pearl	40LCS200	100 ml / 64 g	-	✓	✓	✓	-
 Pearl ruby	40LCS218	100 ml / 64 g	-	✓	✓	✓	-
 Pearl silver	40LCS219	100 ml / 64 g	-	✓	✓	✓	-

The colours shown are indicative. The intensity of the colour obtained may vary depending on the type of surface or mass being coloured, the amount of dye used and the conditions under which it is used. I colori rappresentati sono indicativi. L'intensità del colore ottenuto può variare in base al tipo di superficie o massa che si colora, alla quantità di colorante utilizzato e alle condizioni di utilizzo dello stesso.

Metal Powder

TOP DECORATION

E171
FREE

Fine pearlescent powdered dye, ideal for decorating finished products. Perfect for the surface coloring of fondant, glazes, chocolate, and other sweet products. Non-pressurized spray packaging.

Colorante in polvere fine con effetto perlato, ideale per decorare prodotti finiti. Ideale per la colorazione superficiale di pasta di zucchero, glasse, cioccolato e altri prodotti dolciari. Packaging spray non pressurizzato.



Colour		Cod.	Size	Azo	Azo Free	Gluten Free	Vegan	FDA
	Sparkling pearl bronze	40LCP515	10 g	-	✓	✓	✓	-
	Sparkling pearl cherry red	40LCP513	10 g	-	✓	✓	✓	-
	Sparkling pearl copper	40LCP520	8 g	-	✓	✓	✓	-
	Sparkling pearl gold	40LCP517	10 g	-	✓	✓	✓	-
	Sparkling pearl red	40LCP508	10 g	-	✓	✓	✓	-
	Sparkling pearl silver	40LCP519	10 g	-	✓	✓	✓	-

Dripping Top Decoration

E171
FREE

Ideal for decorating cakes, semifreddo, and ice cream with the dripping technique. It can also be used to decorate cookies and plated desserts. Usage tips: Melt the product in the microwave or using a double boiler. Shake the bottle before use to mix the mixture.

Ideale per la decorazione di torte, semifreddi, gelati con la tecnica del dripping. Può essere utilizzato anche per decorare biscotti e dessert al piatto. Consigli d'uso: sciogliere il prodotto nel microonde o a bagnomaria. Per miscelare il composto agitare il flacone prima dell'uso.



Colour		Cod.	Size	Azo	Azo Free	Gluten Free	Vegan	FDA
	Azure	40LCD003	180 g	-	✓	✓	✓	-
	Cherry red	40LCD008	180 g	✓	-	✓	-	-
	Milk Chocolate	40LCD005	180 g	-	✓	✓	✓	✓
	Pink	40LCD007	180 g	-	✓	✓	-	✓
	White chocolate	40LCD024	180 g	-	✓	✓	-	✓

The colours shown are indicative. The intensity of the colour obtained may vary depending on the type of surface or mass being coloured, the amount of dye used and the conditions under which it is used. I colori rappresentati sono indicativi. L'intensità del colore ottenuto può variare in base al tipo di superficie o massa che si colora, alla quantità di colorante utilizzato e alle condizioni di utilizzo dello stesso.

Glitter Spray

TOP DECORATION

Glittery sprays ideal for decorating the surfaces of cream-based cakes, small chocolate decorations, biscuits, wafers, waffles, and sugar paste-based sweets.

Spray glitterati ideali per decorare superfici di torte a base di panna, piccole decorazioni di cioccolato, biscotteria, wafer, cialde e dolci a base di pasta di zucchero.



Colour		Cod.	Size	Azo	Azo Free	Gluten Free	Vegan	FDA
	Gold <i>New</i>	40LCS417	100 ml / 64 g	-	✓	✓	✓	-
	Silver <i>New</i>	40LCS419	100 ml / 64 g	-	✓	✓	✓	-

Gleam Paillettes

TOP DECORATION

Edible gold and silver sequins ideal for decorating cakes, cookies, creams, ice creams, cream, and other sweet products.

Paillettes edibili colore oro e argento ideali per la decorazione di torte, biscotti, creme, gelati, panna e altri prodotti dolciari.



Colour		Cod.	Size	Azo	Azo Free	Gluten Free	Vegan	FDA
	Pearl gold <i>New</i>	40LCP617	3 g	-	✓	✓	✓	-
	Pearl silver <i>New</i>	40LCP619	3 g	-	✓	✓	✓	-

The colours shown are indicative. The intensity of the colour obtained may vary depending on the type of surface or mass being coloured, the amount of dye used and the conditions under which it is used. I colori rappresentati sono indicativi. L'intensità del colore ottenuto può variare in base al tipo di superficie o massa che si colora, alla quantità di colorante utilizzato e alle condizioni di utilizzo dello stesso.

SPECIAL SPRAY



Butter Spray

Neutral food polish based on cocoa butter, ideal for protecting and polishing marzipan and almond paste.

Lucidante alimentare neutro a base di burro di cacao ideale per proteggere e lucidare marzapane e pasta di mandorle.

Cod.	Size	Azo	Azo Free	Gluten Free	Vegan	FDA
40LCV100	400 ml / 242 g	-	✓	✓	✓	✓



Shiny Spray

Spray lacquer ideal for polishing and protecting sugar and chocolate surfaces.

Gommalacca spray ideale per lucidare e proteggere superfici a base di zucchero e cioccolato.

Cod.	Size	Azo	Azo Free	Gluten Free	Vegan	FDA
40LCS201	300 ml / 168 g	-	✓	✓	✓	✓



Baking Spray

Food release agent to speed up the removal of products from steel and aluminum pans, molds, thermoformed, or other. Odorless and tasteless.

Staccante alimentare per velocizzare la rimozione del prodotto da teglie in acciaio e alluminio, stampi, termoformati o altro. Inodore e insapore.

Cod.	Size	Azo	Azo Free	Gluten Free	Vegan	FDA
COATING	400 ml / 272 g	-	✓	✓	✓	✓



Cooling Spray

Instant cooling spray for sugar or chocolate-based products during artistic processing.

Refrigerante spray per raffreddamento istantaneo di prodotti a base di zucchero o cioccolato durante la lavorazione artistica.

Cod.	Size	Azo	Azo Free	Gluten Free	Vegan	FDA
EUROCHOCK	400 ml / 212 g	-	✓	✓	✓	✓

SPECIALS



Jelly

Food gelatin ideal for garnishing cakes and pastry products in general. It can be colored with water-soluble gels and powders.

Gelatina alimentare ideale per guarnire torte e prodotti di pasticceria in genere. Può essere colorata con i gel e con le polveri idrosolubili.

Cod.	Size	Azo	Azo Free	Gluten Free	Vegan	FDA
40LCJ000	1 kg	-	✓	✓	✓	✓



Sugar Dress

Preparation for the creation of lace and sugar decorations for cakes, pastries and cup cakes. Sugar Dress is a quick and easy way to obtain a refined and impressive sugar decoration. Simply add water to the preparation, mix well and spread it with a spatula on the special silicone mat for sugar decorations. Gluten free. Colour: white.

Preparato per la creazione di pizzi e decorazioni in zucchero per torte, pasticcini e cup cake. Sugar Dress è un sistema facile e veloce per ottenere un decoro in zucchero raffinato e di grande effetto. È sufficiente aggiungere al preparato dell'acqua, mescolare bene il composto e spalmarlo con una spatola nell'apposito tappetino in silicone per decorazioni di zucchero. Gluten free. Colore: bianco.

Cod.	Size	Azo	Azo Free	Gluten Free	Vegan	FDA
EFSD001	500 g			✓	✓	✓



CMC

Food additive used as a thickener. Adding it to sugar paste results in a more resistant and easier-to-shape paste.

Additivo alimentare utilizzato come addensante. Aggiungendolo alla pasta zucchero si ottiene una pasta più resistente e più facile da modellare.

Cod.	Size	Azo	Azo Free	Gluten Free	Vegan	FDA
40W042	40 g	-	✓	✓	✓	✓



Glue

Food glue for creating subjects in sugar paste, plastic chocolate, marzipan, and wafer.

Colla alimentare per la creazione di soggetti in pasta di zucchero e cialda.

Cod.	Size	Azo	Azo Free	Gluten Free	Vegan	FDA
40W166	25 g	-	✓	✓	✓	✓

ALPHABETICAL INDEX

Description	Pag.	Description	Pag.	Description	Pag.
ACETATE	250	GLOVES	418	SNACKS	100
AEROGRAPHERS	444	GRATERS AND ZESTERS	405	SPATULAS	390
BAKING MATS	269	GRIGNOTTINE	432	STAINLESS STEEL BANDS	276
BAKING PAPER	264	GITARS	352	STAMPS	192
BAKING TRAYS	288	HALLOWEEN MOULDS	136	SUGAR LAMP	447
BALL SHAPING MACHINE	338	ICE-CREAM SPATULAS	310	TEMPLATES	198
BAR MOULDS	84	ICE LOLLIES MOULDS	302	THERMOMETERS	422
BISCUIT CUTTER	291	ICE MARKERS	312	TORCHES	420
BOWLS	406	ICE-CREAM, MOULDS	296	TRAVEL CAKES	254
BREAD BASKETS	413	JELLIES, MOULDS	273	TRAYS	268
BREAD MOULDS	412	LEVEL, DOUGH SPREADER	342	WARMING PLATE	365
BRUSHES	408	LIDS	450	WHIPPERS	425
CAKE BOARDS	518	LOG	293	WHISKS	394
CAKE DRUMS	516	LOLLIPOP	184		
CAKE LIFTER	427	MACARON DISPLAYS	520		
CAKE SLICER	434	MART CUTTER	346		
CAKE STANDS	504	MELTERS	326		
CAKE TURNING ROD	277	MELTERS FOR ICE-CREAM SHOP	308		
CAKE TURNTABLES	426	MICRO-PERFORATED	258		
CANNOLI MOULDS	290	MULTIPURPOSE BOARDS	453		
CARAFES	414	NAPOLITAIN	182		
CARAMMELOMETER	447	ONE STRIP SEMIFREDDO MOULDS	240		
CHOCOLATE 3D FIGURES	112	PANDORO, MOULD	289		
CHOCOLATE FORKS	204	PASTRY BAGS	370		
CHOCOLATE FOUNTAINS	334	PINCERS	409		
CHRISTMAS	115	PIPING TIPS	376		
COLOURANTS	530	PLATES	484		
CROISSANT CUTTER	404	PORTIONERS, ICE-CREAM	311		
CUPS	458	PRALINE MOULDS	22		
CUTTERS	416	PRICE MARKERS	435		
CUTTING DOCKERS	403	REFRACTOMETER	435		
DECORATIVE MATS	440	ROLLING MACHINE	364		
DECORATIVE CHABLONS	204	ROLLING PINS	407		
DECORATIVE COMBS	438	SCALES	433		
EASTER	138	SCRAPERS	396		
EXTENDABLE PASTRY CUTTER	400	SEMISPHERES	188		
FINGER FOOD DISPLAYS	492	SHOWCASES	524		
FLACONS	414	SIEVES	434		
FLOUR SCOOPS	406	SILICONE BAKING PAN	272		
FUNNELS	424	SILICONE MOULDS	208		
GANACHE FRAMES	429				

INDICE ALFABETICO

Descrizione	Pag.	Descrizione	Pag.	Descrizione	Pag.
ACETATI	250	NAPOLITAIN	182	TAPPETI DECORO	440
AEROGRAFI	444	NATALE	115	TAVOLE MULTIUSO	453
AGHI PANETTONE	277	ONE STRIP STAMPI SEMIFREDDO	240	TAVOLETTE, STAMPI	84
ALZATE TORTA	504	PALA PER DOLCI	427	TEGLIE	268
BICCHIERINI E COPPETTE	458	PALLINATORE	338	TELAI GANACHE	429
BILANCE	433	PANDORI, STAMPO	289	TERMOMETRI	422
BOCCHETTE	376	PANE, STAMPI	412	TIMBRI	192
CANNELLI	420	PASQUA	138	TORTIERE SILICONE	272
CANNOLI, STAMPI	290	PENNELLI	408	TRAVEL CAKE	254
CARAFFE	414	PETTINI DECORATIVI	438	TRONCHETTI	293
CARAMELLOMETRO	447	PIANO RISCALDANTE	365	VASSOI	450
CARTA FORNO	264	PIATTINI	484	VETRINE	524
CESTINI PANE	413	PINZE	409		
CHABLON DECORATIVI	204	PORZIONATORI, GELATO	311		
CHITARRE	352	PRALINE, STAMPI	22		
CIOTOLE	406	RASCHIE	396		
COLINI	424	RIFRATTOMETRO	435		
COLORANTI ALIMENTARI	530	RULLI	407		
COPERCHI	450	RULLI FORAPASTA	403		
DIME	198	SAC A POCHE	370		
ESPOSITORI FINGER FOOD	492	SCIOGLITORI	326		
ESPOSITORI MACARON	520	SCIOGLITORE PER GELATERIA	308		
FASCE INOX	276	SEGNAGUSTO	312		
FLACONI	414	SEGNAPREZZO	435		
FONTANE PER CIOCCOLATO	334	SEMISFERE	188		
FORCHETTINE CIOCCOLATO	204	SESSOLE	406		
FRUSTE	394	SETACCI	434		
GELATI, STAMPI	296	SIFONI	425		
GELATINE, STAMPI	273	SILICONE, STAMPI	208		
GHIACCIOLI, STAMPI	302	SNACK	100		
GIRATORTA	426	SOGGETTI IN CIOCCOLATO	112		
GRATTUGIE E ZESTER	405	SOTTOTORTA	518		
GRIGNOTTINA	432	SPATOLE	390		
GUANTI	418	SPATOLE GELATO	310		
HALLOWEEN, STAMPI	136	STENDIPASTA	364		
LAMPADA DA ZUCCHERO	447	TAGLIA CROISSANT	404		
LEVEL, STENDI IMPASTO	342	TAGLIABISCOTTI	291		
LIRA	434	TAGLIAPASTA ESTENSIBILE	400		
LOLLIPOP	184	TAGLIERINI	416		
MART CUTTER, TAGLIANASTRI	346	TAMBURI PER TORTE	516		
MICROFORATI	258	TAPPETI COTTURA	269		

NUMERICAL INDEX/INDICE NUMERICO

Cod.	Pag.	Cod.	Pag.	Cod.	Pag.	Cod.	Pag.	Cod.	Pag.	Cod.	Pag.
10-E002	304	20-3D2001	72	20FH52	197	20SR003A	153	20U320	154	30MICRO06	262
104000	299	20-C1010	130	20FH53	197	20SR004	153	20U3D01	150	30MICRO07	262
104001	299	20-C1955	163	20FRUIT..	72	20SR004A	153	20U3D02	150	30MICRO08	262
104002	300	20-C1957	163	20GU001	179	20SR020	142	20U3D03	150	30MICRO09	262
104003	300	20-CU001	155	20GU002	179	20SR020A	142	20U3D04	150	30MICRO10	263
105000	304	20-D029	191	20GU003	179	20SR021	142	20U3D05	150	30MICRO11	263
105002	304	203D01	73	20GU004	180	20SR021A	142	20U3D06	150	30SF001	236
10CG30	311	203D02	73	20GU005	180	20SR022	142	20U3D07	148	30SF002	236
10CG42	311	203D03	73	20GU006	180	20SR022A	142	20U3D08	149	30SF003	236
10CG60	311	203D04	73	20GU007	181	20SR100	117	20U500	147	30SF004	236
10CG70	311	20A3D01	118	20GU008	181	20SR100A	117	20U501	146	30SF005	236
10E006	301	20A3D02	118	20GU009	181	20SR101	133	20U502	145	30SF006	236
10E007	301	20BA01	167	20GU500	181	20SR101A	133	20U503	145	30SF007	228
10PG01	311	20CG01	171	20GU501	181	20SR102	132	20U504	145	30SF008	233
10PG02	311	20CO01	118	20GU502	181	20SR102A	132	20WT01	171	30SF009	233
10PG03	311	20CO02	118	20HO01	134	20SR103	121	21MA1059	47	30SF010	235
10PG04	311	20CT01	118	20L001	184	20SR103A	121	21MA1063	33	30SF011	230
10PG05	311	20FH01L	196	20L002	184	20SR104	121	21MA1065	29	30SF012	230
10SA001B	313	20FH01S	196	20L003	184	20SR104A	121	21SR005AG	156	30SF013	233
10SA001N	313	20FH02L	198	20L004	184	20SR105	121	21SR005G	156	30SF014	233
10SEG	312	20FH02S	198	20L005	185	20SR105A	121	21SR006AG	157	30SF015	227
10SEG05	312	20FH03L	199	20L006	185	20SR106	127	21SR006G	157	30SF016	227
10SEG06	313	20FH03S	199	20L007	184	20SR106A	127	21SR007AG	158	30SF017	233
10SEGB	313	20FH04	196	20L008	184	20SR107	127	21SR008AG	159	30SF019	234
10SG00	310	20FH05	198	20OB01	171	20SR107A	127	21SR008G	159	30SF020	229
10SG01	310	20FH06	199	20PA01	167	20SR108	116	21U505	139	30SF021	229
10SG07	310	20FH07L	197	20PP01	171	20SR108A	116	21U506	141	30SF022	226
10SGC00	310	20FH07S	197	20PR01	135	20TC001	97	23H4..	282	30SF023	226
10SGC01	310	20FH30L	195	20S005	185	20TC002	97	23H5..	282	30SF024	226
10SGC07	310	20FH30S	195	20SF001	188	20TC003	97	30BANDS01	260	30SF025	235
10SI001B	312	20FH31L	195	20SF002	188	20TC004	97	30BANDS02	260	30SF026	231
10SI002B	312	20FH31S	195	20SF003	123	20TC005	97	30BANDS03	260	30SF027	233
10SL072	301	20FH32L	194	20SF005	123	20TC006	97	30BANDS04	260	30SF028	227
10SL114	301	20FH33L	194	20SF006	123	20U032N	154	30BANDS05	260	30SF029	234
11H4..	287	20FH34L	194	20SF008	123	20U064N	154	30BANDS06	260	30SF030	234
11H5..	287	20FH35L	193	20SI01	170	20U105N	154	30BANDS07	260	30SF031	232
1H2..	285	20FH36L	195	20SL01	134	20U130N	154	30H4..	288	30SF032	232
1H3..	285	20FH36S	195	20SR001	153	20U150N	154	30MICRO01	263	30SF033	235
1H4..	285	20FH37L	195	20SR001A	153	20U175N	154	30MICRO02	263	30SF034	228
1H5..	285	20FH37S	195	20SR002	153	20U204N	154	30MICRO03	263	30SF035	228
1H6..	285	20FH38L	193	20SR002A	153	20U227N	154	30MICRO04	263	30SF036	228
20-3D1002	72	20FH51	197	20SR003	153	20U258	154	30MICRO05	263	30SF037	235

Cod.	Pag.	Cod.	Pag.	Cod.	Pag.	Cod.	Pag.	Cod.	Pag.	Cod.	Pag.
30SF040	228	30SIL506	225	40-W090	517	40WC3..	542	50CI22X14	290	50FN35	394
30SF042	227	30SIL507	225	40-W101	517	40WCB0..	532	50CO001	424	50FN40	394
30SF044	234	30SIL508	222	40-W106	516	41H4..	281	50CO002	424	50FN45	394
30SF045	231	30SIL509	224	40-W110	516	42H4..	283	50CO30X12	290	50GD0015	402
30SF046	231	30SIL510	221	40-W111	516	42H5..	283	50CO35X14	290	50GD0018	402
30SF047	231	30SIL511	222	40-W112	516	43H4..	281	50CO40X16	290	50GD0022	402
30SF048	235	30SIL512	220	40-W113	516	44H4..	282	50COL50	416	50GD0027	402
30SF049	231	30SIL513	220	40-W124	517	45H4..	282	50COL51	416	50GD0037	402
30SF050	231	30SIL514	223	40-W125	426	46H4..	280	50CP01	455	50GD2040	402
30SF051	228	30SIL515	220	40-W141	443	47H4..	281	50CS200	355	50GD3060	402
30SF052	226	30SIL600	215	40-W154	407	48H4..	280	50CSBA	355	50GIRA02	289
30SF054	231	30SIL601	216	40-W167	443	49H4..	280	50CSTE15	355	50GO275	390
30SF056	228	30SIL602	217	40-W200	364	49H4X25	280	50CSTE22	355	50GO300	391
30SF057	227	30SP0100	289	40-W20045	364	50-1030	372	50CSTE30	355	50GO350	391
30SF058	227	30SP0250	289	40-WA007	443	50-1040	372	50CSTE37	355	50GO400	391
30SF059	231	30SP0500	289	40H4..	288	50-1055	372	50CSTE45	355	50LE001	345
30SF061	228	30SP0750	289	40LCA0..	537	50-1065	372	50DF138	431	50MC001	349
30SF102	226	30SP1000	289	40LCA4..	538	50-2030	372	50DF158	431	50PE30	409
30SF103	231	30TC50F	256	40LCB0..	532	50-2040	372	50DF178	431	50PE40	409
30SF114	227	30TC51F	256	40LCD0..	553	50-2055	372	50DF198	431	50PE50	409
30SF155	227	30TC52F	256	40LCG0..	534	50-2065	372	50DI20	518	50PE60	409
30SF161	234	30TC53F	256	40LCJ000	558	50-C015	357	50DI22	518	50PE70	409
30SF168	227	30TC54F	257	40LCL0..	5388	50-C022	357	50DI24	518	50PI01	395
30SF170	228	30TC55	257	40LCP0..	544	50-C030	357	50DI26	518	50PI02	395
30SF180	234	30TC56	257	40LCP1..	544	50-C045	357	50DI28	518	50PI03	395
30SF500	236	30TE3001R	271	40LCP2..	540	50-CD100N	357	50DI30	518	50PI04	395
30SF501	236	30TE3002R	271	40LCP3..	542	50-CS100	357	50DI32	518	50PI05	395
30SF502	236	30TE6001R	271	40LCP5..	552	50103020STD	372	50DI34	518	50PRO02	365
30SIL01N	239	30TE6002R	271	40LCP6..	555	50104020STD	372	50ES01	341	50QG03	430
30SIL02N	239	30TM3001R	271	40LCPN2..	546	50105520STD	372	50ES02	341	50QG05	430
30SIL03N	239	30TM6001R	271	40LCPN3..	547	50BIO1	433	50FA01	394	50QG10	430
30SIL04N	238	30TT104S	275	40LCS0..	550	50BIO2	433	50FA02	394	50QG15	430
30SIL05N	238	31CUT01	465	40LCS2..	551	50CA01	420	50FA03	394	50RAS1	398
30SIL06N	238	31CUT02	271	40LCS201	557	50CA02	420	50FA04	394	50RAS2	398
30SIL07N	238	31CUT03	463	40LCS4..	554	50CA604007C	454	50FA05	394	50RAS4	396
30SIL08N	239	31CUT04	462	40LCV0..	549	50CA604010C	454	50FA06	394	50RAS5	396
30SIL500	224	40-W004	442	40LCV100	556	50CA604013C	454	50FL00	414	50RAS6	396
30SIL501	224	40-W021	407	40PI01	517	50CA6040COP	454	50FL00C	414	50RAS7	396
30SIL502	224	40-W022	407	40W042	558	50CHOC..	204	50FLAN2	414	50RFP12A	403
30SIL503	222	40-W087	517	40W166	559	50CHOC10	204	50FLAN2T	414	50RI01	435
30SIL504	225	40-W088	517	40WCO..	544	50CI12X20	290	50FN25	394	50RPL12X	403
30SIL505	225	40-W089	517	40WC1..	544	50CI16X20	290	50FN30	394	50RTA1	399

Cod.	Pag.	Cod.	Pag.	Cod.	Pag.
5ORTA2	399	50T004	423	53TAF40302	268
5ORTD1	399	50T005	423	53TAF40304	268
5ORTF1	399	50TLM03	429	53TAF60404	268
5ORTF2	399	50TLM05	429	53TL60404	268
5ORTL1	399	50TLMINI	429	5H2..	286
5ORTL2	399	50TLS03	429	5H3..	286
5ORTP1	399	50TLS05	429	5H4..	286
5ORTP2	399	50TLSPECIAL	429	5H5..	286
5ORTS1	399	50VA001A	373	5H6..	286
5ORTT1	399	50WA004B	442	80A0900	513
5OSC350	390	50WA005B	442	80A0908	513
5OSC400	390	50ZES01	405	80A1000	513
5OSI01	425	50ZES02	405	80A1008	513
5OSI02	425	50ZES03	405	80A1300	508
5OSIRO1	425	51CF6040	269	80A1400	507
5OSPA01	393	51MP6040	267	80A1500	507
5OSPA02	393	51VP014510	527	80A1600	507
5OSPA03	393	51VP014515	527	80A1900	511
5OSPA04	393	51VP014525	527	80D0100	501
5OSPANG01	393	51VP016010	527	80D0200	500
5OSPANG02	393	51VP016015	527	80D0300	500
5OSPANG03	393	51VP016025	527	80D0400	500
5OSPANG04	393	51VP024510	527	80D0500	499
5OSPB30	359	51VP024515	527	80D0600	499
5OSPB30	429	51VP024525	527	80D0700	499
5OSPB30	429	51VP026010	527	80D0800	499
5OSPB30	431	51VP026015	527	80D0900	494
5OSPB43	359	51VP026025	527	80D1000	494
5OSPB43	431	52BO13PC	406	80D1900	496
5OSR340	392	52BO13PP	406	80D2000	497
5OST01	455	52BO17PC	406	80DM01	522
5OST18	518	52BO17PP	406	80DM02	522
5OST20	518	52BO23PC	406	80DM03	522
5OST22	518	52BO23PP	406	80ET007	99
5OST24	518	52BO28PC	406	80ET008	98
5OST26	518	52BO28PP	406	80ET009	99
5OST28	518	52BO32PC	406	80RIC1300	508
5OST30	518	52BO32PP	406	AG00206N	314
5OST32	518	52BO38PC	406	AG00208N	314
5OST40	518	52BO38PP	406	AG00606	319
50T002	422	53GP01	289	AG00706P	318
50T003	422	53TA60404	268	AG00708P	318

Cod.	Pag.	Cod.	Pag.	Cod.	Pag.
AG00906P	318	BA1830	323	BF 318	377
AG00908P	318	BA2008	323	BF 319	377
AG00930	318	BA2015	323	BIM 232	385
AG01410	320	BA2020	323	BIM 340	385
AG01420	320	BA2025	323	BIM230	385
AG01430	320	BA2030	323	BO1000N	415
AG01710	320	BASKET 102	413	BO100N	415
AG01720	320	BASKET 103	413	BO250N	415
AG01801	319	BASKET 105	413	BO500N	415
AG03000	315	BASKET 106	413	BOS 26	386
AG03108	314	BASKET 107	413	BOS 36 BIG	386
AG03306	314	BASKET 108	413	BOS 52	386
AG03640	317	BASKET 205	413	BOS12FLO	386
AG03650	317	BASKET 206	413	BOX0801	321
AG03720	320	BASKET 207	413	BOX1201	321
AG03730	320	BASKET 208	413	BOX1601	321
AG04610	317	BC 0855	380	BOX1602	321
AG05301	319	BC 320	377	BOX2402	321
AG05601	523	BC 321	377	BOX2403	321
AG05701	523	BC 322	377	BOX3202	321
AG05801	523	BC 323	377	BOX3603	321
AG07701	523	BC 324	377	BOX4803	321
AG07701P	523	BC 325	377	BR 330	380
AG07901	523	BC 326	377	BR 331	380
AR0001	529	BC 327	377	BR 332	380
AR00011	529	BC 328	377	BRU	387
BA 411	380	BC 329	377	BS 0195	380
BA 413	380	BC 330	377	BS 0195K	380
BA 415	380	BD 300	378	BS 0D6K	380
BA1008	323	BD 301	378	BS 0F6K	380
BA1015	323	BD 302	378	BS 10 S	376
BA1020	323	BF 0867	377	BS 10 T	376
BA1208	323	BF 0869	377	BS 102	376
BA1215	323	BF 310	377	BS 103	376
BA1220	323	BF 311	377	BS 104	376
BA1508	323	BF 312	377	BS 105	376
BA1515	323	BF 313	377	BS 106	376
BA1520	323	BF 314	377	BS 107	376
BA1808	323	BF 314/11	377	BS 108	376
BA1815	323	BF 315	377	BS 109	376
BA1820	323	BF 316	377	BS 110	376
BA1825	323	BF 317	377	BS 111	376

Cod.	Pag.	Cod.	Pag.	Cod.	Pag.
BS 112	376	BX 1217	378	BX0043	378
BS 113	376	BX 1303	378	BX0045	384
BS 114	376	BX 1405	378	BX0046	384
BS 115	376	BX 1510	378	BX0047	384
BS 116	376	BX 1605	383	BX0048	384
BS 117	376	BX 1713	383	BX0049	379
BS 118	376	BX 1820	384	BX0052	382
BT 202	376	BX 1906	379	BX0053	382
BT 203	376	BX 2013	381	BX0054	382
BT 204	376	BX 2117	382	BX0055	381
BT 205	376	BX 2219	382	BX0056	381
BT 206	376	BX 2312	378	BX0058	382
BT 207	376	BX 4014	381	BX0059	382
BT 208	376	BX 5017	380	BX0060	381
BT 209	376	BX 6018	380	BX0062	383
BT 210	376	BX 7020	380	BX0100	385
BT 211	376	BX 8019	379	BX0101	385
BT 212	376	BX 9017	378	BX0102	385
BT 213	376	BX 9022	378	BX0103	385
BT 214	376	BX0001	384	BX0104	385
BT 215	376	BX0002	382	BX9990	379
BT 216	376	BX0004	381	BX9991	379
BT 217	376	BX0006	381	BX9992	379
BT 218	376	BX0008	382	BXB01	383
BT 220	376	BX0009	384	BXB02	383
BT 222	376	BX0011	381	CANNELLOBIG	421
BT 224	376	BX0012	382	CANNELLOPRO	421
BX 0108	380	BX0014	381	CANNOLO	290
BX 0116	379	BX0016	382	CFTRA 1	415
BX 0119	379	BX0017	381	CFTRA 2	415
BX 0120	381	BX0023	382	CFTRA 3	415
BX 0123	381	BX0026	378	CFTRA 4	415
BX 0134	378	BX0027	378	CFTRA6	415
BX 0158	378	BX0028	384	CFTRA6C	415
BX 0190	380	BX0029	384	CHASIL...	202
BX 0252	384	BX0030	384	CHIT15	359
BX 0510	380	BX0035	383	CHIT22	359
BX 1013	380	BX0036	383	CHIT30	359
BX 1105	383	BX0037	383	CHITBA24	359
BX 1115	383	BX0038	384	CHITBAD24	358
BX 1123	383	BX0041	383	CHITMINI	358
BX 1132	383	BX0042	384	CHITMINI15	358

Cod.	Pag.	Cod.	Pag.	Cod.	Pag.
CHITMINI30	358	CSM04006	362	CUT7L9	291
CHITMINID22	358	CSM04007	362	CUT8L7	292
CHITMINID30	358	CSM04008	362	CUTTER 1	417
CHITP	359	CSM04009	362	CUTTER 4	417
CHITRIC 10	359	CSM0402	363	CUTTER 5	417
CHITRIC 10	363	CSM060	362	CUTTER 7	416
CHITRIC 6/D	359	CSM06001	363	CUTTER 8	416
CHITRIC 8	359	CSM06002	363	DECOAIR 2	445
CHITRIC 8	363	CSM06003	363	DECOAIR 6	445
CHITRIC 9	359	CSM06004	363	DECOCP02	445
CHITRIC 9	363	CSM06005	363	DECOMP 7	444
CHITRIC 9A	359	CSM06006	363	DECOMP9	444
CHOCOBIGEV	334	CSM06007	363	DECOR 30	402
CHOCOFONT	334	CSM06008	363	DRIP	237
CHOCOFORK	204	CSM06009	363	ED 1	247
CIOK 1	432	CSM0602	363	ED 2	247
CLP01	302	CSMSPB40	363	EFSD001	559
CLPESPO21	303	CSMSPB40	431	EL101	185
CLPESPOB	303	CSMSPB60	363	EM 1	248
CLPESPOBTRA	303	CSMSPB60	431	EM 2	248
COATING	556	CUT10L9	293	EM 5	249
COD. 307	503	CUT12L7	293	EM 7	249
COD. 504	511	CUT15L7	293	EM 8	249
COD. 603	503	CUT18L7	293	ESPO ST	387
COD512	514	CUT1F12	291	ESPOB60	387
COD513	514	CUT1F9	291	ESPOBO32	387
COD514	515	CUT1FM12	291	ESPOP30	373
COD60501	503	CUT1L12	291	ESPOP40	373
COVER 3	451	CUT1L16	291	ESPOP55	373
COVER 3H4	451	CUT1L7	291	ET004	99
COVER 3H45	451	CUT1L9	291	ET004B	99
COVER 4	451	CUT1LM12	291	EUROCHOCK	557
COVER 8	451	CUT22L7	292	FLACONE	414
COVER3H48	451	CUT26L7	293	FLACONE2	414
CS3	434	CUT28L7	292	FLAN1	414
CSL	434	CUT31L7	293	FLEX 034 CM	375
CSM040	362	CUT3L7	292	FLEX 040 CM	375
CSM04001	362	CUT5L7	292	FLEX 046 CM	375
CSM04002	362	CUT6L7	292	FLEX 050 CM	375
CSM04003	362	CUT7F9	291	FLEX 055 CM	375
CSM04004	362	CUT7L12	291	FLEX 060 CM	375
CSM04005	362	CUT7L7	291	FLEX 065 CM	375

Cod.	Pag.	Cod.	Pag.	Cod.	Pag.
FLEX 070 CM	375	MA1026	175	MA1513	79
GIRA	427	MA1027	175	MA1521	67
GIRA5	426	MA1028	175	MA1526	79
GIRA6	426	MA1030	175	MA1527	67
GIRA7	427	MA1031	82	MA1529	67
GL 1	418	MA1033	59	MA1530	67
GL 2	418	MA1034	59	MA1604	68
GL 3	418	MA1035	59	MA1606	68
GL10	419	MA1036	59	MA1607	68
GL11	419	MA1037	67	MA1609	68
GL18PRE	419	MA1038	61	MA1610	68
GL25PRE	419	MA1039	61	MA1611	68
Globe	149	MA1040	61	MA1612	68
GST01	305	MA1041	51	MA1613	79
GST10	305	MA1042	51	MA1618	68
GSTESPOB	305	MA1043	51	MA1619	68
INOX 3	443	MA1044	64	MA1620	68
LAMPO1	447	MA1045	65	MA1621	68
MA1002	67	MA1046	67	MA1622	68
MA1003	56	MA1047	45	MA1624	68
MA1004	56	MA1048	65	MA1625	68
MA1005	56	MA1049	65	MA1629	68
MA1006	56	MA1050	42	MA1631	68
MA1007	55	MA1051	44	MA1632	68
MA1008	55	MA1052	43	MA1638	68
MA1009	55	MA1053	81	MA1640	68
MA1010	55	MA1054	81	MA1800	68
MA1011	67	MA1055	80	MA1801	68
MA1012	67	MA1056	80	MA1802	68
MA1013	65	MA1057	39	MA1803	68
MA1014	65	MA1058	35	MA1804	68
MA1015	65	MA1060	37	MA1900	68
MA1016	65	MA1061	83	MA1903	71
MA1017	82	MA1062	41	MA1907	71
MA1018	49	MA1064	67	MA1914	102
MA1019	67	MA1074	67	MA1915	102
MA1020	67	MA1082	67	MA1916	102
MA1021	52	MA1091	67	MA1918	106
MA1022	52	MA1094	67	MA1919	106
MA1023	52	MA1281	67	MA1920	105
MA1024	52	MA1303	67	MA1921	105
MA1025	67	MA1350	67	MA1922	105

Cod.	Pag.	Cod.	Pag.	Cod.	Pag.
MA1923	106	MA2003	71	MA4010	61
MA1924	104	MA2005	96	MA4011	61
MA1925	71	MA2006	182	MA4012	61
MA1926	105	MA2007	183	MA5000	188
MA1927	71	MA2008	94	MA5001	188
MA1951	176	MA2009	89	MA5002	188
MA1953	176	MA2010	96	MA5003	188
MA1962	79	MA2011	95	MA5004	188
MA1963	71	MA2012	94	MA5005	188
MA1964	71	MA2013	94	MA5006	188
MA1965	71	MA2014	94	MA5007	188
MA1966	71	MA2015	94	MA5008	188
MA1968	71	MA2016	96	MA5009	188
MA1969	71	MA2017	96	MA5010	188
MA1970	71	MA2019	94	MA6001	183
MA1971	71	MA2020	92	MA6002	183
MA1972	71	MA2021	93	MA6003	183
MA1974	75	MA2022	90	MA6005	182
MA1975	75	MA2023	91	MA6006	182
MA1980	71	MA2024	91	MA6100	110
MA1981	71	MA2025	91	MA6101	110
MA1982	71	MA2026	91	MA6102	110
MA1983	71	MA2027	86	MA6103	110
MA1984	76	MA2028	87	MA7000	109
MA1985	71	MA2029	88	MA7001	109
MA1986	71	MA3005	191	MA7002	109
MA1987	71	MA3006	176	MA7003	81
MA1988	71	MA3007	71	MAC140S	131
MA1989	71	MA3008	128	MAC170S	131
MA1990	75	MA3009	115	MAC320S	131
MA1991	75	MA3010	124	MAC322S	171
MA1992	82	MA3011	77	MAC323S	171
MA1993	78	MA3012	115	MAC324S	136
MA1994	48	MA3013	129	MAC326S	167
MA1995	168	MA3014	127	MAC330	167
MA1996	168	MA3015	169	MAC406S	136
MA1997	65	MA3016	161	MAC407S	131
MA1998	65	MA3017	115	MAC421S	131
MA1999	65	MA3018	136	MAC602S	162
MA2000	96	MA4005	62	MAC604S	162
MA2001	96	MA4006	62	MAC615S	165
MA2002	183	MA4007	62	MAC616S	165

Cod.	Pag.	Cod.	Pag.	Cod.	Pag.	Cod.	Pag.	Cod.	Pag.	Cod.	Pag.
MAC620S	165	MIGNON C001	247	ONE14H40	245	PMOCL001C	465	PPT14X	434	ROLL H 40	373
MAC661S	165	MIGNON C002	247	ONE16	245	PMOCL002	465	PPT16X	434	ROLL H 55	373
MAC720S	165	MONOP. A001	248	ONE18	245	PMOCL002C	465	PPT18X	434	ROLL H 65	373
MC000305	333	MONOP. A002	248	ONE20	245	PMOCO001	474	PPT8X	434	ROLLH3020STD	373
MC001001	309	MONOP. A005	249	ONE22	245	PMOCO002	474	PR30	411	ROLLH4020STD	373
MC09G	333	MONOP. A007	249	PC100	402	PMOCO003	474	PR30X30	411	ROLLH5520STD	373
MC09N	333	MONOP. A008	249	PC120	402	PMOCO004	475	PR40	411	ROTAPINOX 5 O	400
MC09R	333	MONOP. B001	248	PC55	402	PMOCO005	475	PR40X60	411	ROTAPINOX 5 P	400
MC10	309	MONOP. B002	248	PC65	402	PMOCO006	479	PR50X50	411	ROTAPINOX 7 O	400
MC100	331	MONOP. B005	249	PD 1/2	439	PMOCO007	475	RAS 3	398	ROTAPINOX 7 P	400
MC101	331	MONOP. B007	249	PD 3/4	439	PMOCO008	476	RC115	398	ROTINOX 5 P/O	400
MC102	331	MONOP. B008	249	PD13/14	439	PMOCO009	476	RD105	398	ROTINOX 7 P/O	400
MC103	331	MONOP. C001	248	PDM 1/2	439	PMOCO010	476	RD125	398	RPL 12	403
MC104	331	MONOP. C002	248	PDM 3/4	439	PMOCO011	478	RD150	398	RSC180X140	404
MC105	331	MONOP. C005	249	PDS1/2	439	PMOCO012	478	RD175	398	RSC180X200	404
MC106	331	MONOP. C007	249	PDS3/4	439	PMOCO013	472	RDC180X200	404	RSC70X100	404
MC107	331	MONOP. C008	249	PINZA	409	PMOCO014	472	RELIEF 1	440	RSC96X153	404
MC108	331	MSC001	205	PL00100	486	PMOCO015	478	RELIEF 11	441	RSC97X210	404
MCD101	329	MSC002	205	PL00101	486	PMOCU001	469	RELIEF 12	441	RTC180X200	404
MCD102	329	MSC003	205	PL00102	486	PMOCU002	469	RELIEF 2	440	SEG002N	435
MCD103	329	MSC004	205	PL00200	487	PMOCU002/C	466	RELIEF 4	440	SEG006N	435
MCD104	329	MSC201	205	PL00201	487	PMOCU002/C	469	RELIEF 5	440	SES 1500	406
MCD103	329	MSC202	205	PL00202	487	PMOCU003	469	RELIEF 7	441	SES 100	406
MEL 250	391	MTE	447	PL00300	487	PMOCU003/C	469	RELIEF 9	441	SES 250	406
MEL 350	391	NSA H 25	250	PL00301	487	PMOCU004	466	RETH4	287	SES 500	406
MEL 450	391	NSA H 30	250	PL00302	487	PMOFT001	462	RETH5	287	SES 800	406
MEX 250	392	NSA H 35	250	PMO07.00	467	PMOFT001C	462	RETSPECIAL 1	287	SET DISK	518
MEX 300	392	NSA H 40	250	PMO07/C	467	PMOJA001	479	RETSPECIAL 2	287	SETAC 16	434
MEX 400	392	NSA H 45	250	PMO08.00	472	PMOJA002	479	RFP 12	403	SETAC 19	434
MEX 500	392	NSA H 50	250	PMO09.00	482	PMOLO001	468	RL 2	407	SETAC 21	434
MFRU 25	394	NSA H 55	250	PMO10.00	483	PMOLO001/C	468	RL 3	407	SETAC 24	434
MFRU 30	394	NSA H 60	250	PMO10.02	483	PMOPE001	472	RL 4	407	SETAC 26	434
MFRU 35	394	NSA25X150	251	PMO11.00	483	PMOTO001	470	RLS 30	407	SETAC 28	434
MFRU 40	394	NSA27X27MO	251	PMO11.01	483	PMOTO002	470	RLS 35	407	SETAC 30	434
MFRU 45	394	NSA300X300	250	PMO11.02	483	PMOTO003	470	RLS 40	407	SFT 118/Y	272
MFRU 50	394	NSA30X240	251	PMO12.00	482	PMOTO004	470	RLS 45	407	SFT 120/Y	272
MICROMAT30	263	NSA39X39MO	251	PMO13.00	482	PMOTO005	463	RLS 50	407	SFT 122/Y	272
MICROMAT60	263	NSA400X600	250	PMO14.00	482	PMOTO005/C	463	RLS 60	407	SFT 124/Y	272
MIGNON A001	247	NSA40X240	251	PMOCE001	477	PMOVA003.00	482	RLS50PE	407	SFT 126/Y	272
MIGNON A002	247	NSA60X40MO	251	PMOCE002	477	POMP	447	RLS60PE	407	SFT 128/Y	272
MIGNON B001	247	ONE06	245	PMOCE003	477	PPT10X	434	RLS70PE	407	SFT 210/Y	272
MIGNON B002	247	ONE14H35	245	PMOCL001	465	PPT12X	434	ROLL H 30	373	SFT 220/Y	272

Cod.	Pag.	Cod.	Pag.	Cod.	Pag.
SFT 224/Y	272	SPR045	374	TPM 1	247
SFT 250/Y	272	SPR045/C	374	TPM 2	247
SFT 251/Y	272	SPR050	374	TS1	427
SFT 300/Y	272	SPR050/C	374	VASSOIOAMI	451
SFT 326/Y	272	SPZ INOX	408	VASSOIOAMO	451
SFT 330/Y	272	SPZ PL1	408	VASSOIOBMI	451
SFT 424/Y	272	SPZ SE	408	VASSOIOBMO	451
SFT 426/Y	272	ST 1	275	VASSOIOCFMI	451
SFT 428/Y	272	ST 2	275	VASSOIOCFMO	451
SFT 522/Y	272	ST 4	275	VB00150	323
SFT 600/Y	272	STD 034 CM	375	VB00201	528
SG 01	273	STD 040 CM	375	VB00208	528
SG 02	273	STD 046 CM	375	VB00308	528
SG 03	273	STD 050 CM	375	VB00408	528
SG 04	273	STD 055 CM	375	VC30X40	451
SG 05	273	STD 060 CM	375	VC60X40	451
SG 06	273	STD 065 CM	375	VC60X404	451
SG 07	273	STD 070 CM	375	VC60X408	451
SG 08	273	STD 075 CM	375	VP00101	525
SG 09	273	STPTA 1	412	VP00206	526
SILICOPAT1/B	270	STPTA 2	412	VP00301	526
SILICOPAT1/R	270	STPTA 5	412	VP00401	526
SILICOPAT2/B	270	SUT25X17	154	VP00501	526
SILICOPAT2/R	270	SUT28X18	154	VP00906	526
SILICOPAT3/B	270	SUT34X25	154	VP01001	526
SILICOPAT4/B	270	SUT40X27	154	VP01106	526
SILICOPAT6/R	270	SUT45X32	154	VP01201	526
SILICOPAT7/R	270	SUT54X36	154	ZENBO00	491
SM 1000	155	SUT64X43	154	ZENBO00C	491
SM 2000	155	SUT75X50	154	ZENBO01	491
SM 2300	155	TAV 59X39	453	ZENBO02	491
SM 2500	155	TAV60X40	453	ZENTR00	490
SM 3000	155	TEFLONPAT5	269	ZENTR01	490
SM 3500	155	TL 03	430	ZENTR02	490
SM 4000	155	TL 04	430		
SMA110	274	TL 05	430		
SMA180	274	TL 15	430		
SMA260	274	TPG 1	248		
SPB SPECIAL	431	TPG 2	248		
SPINNER	351	TPG 5	249		
SPR034	374	TPG 7	249		
SPR034/C	374	TPG 8	249		

Martellato srl, accordingly to EC laws:

EC Regulation no. 1935/2004- Materials and articles intended to come into contact with food.

EU Regulation no. 10/2011 and smi- Regarding the materials and plastic articles intended to come into contact with food.

EC Regulation no. 2023/2006 -Good Manufacturing Practices (GMP) of materials and articles intended to come into contact with food.

And to the following National Legislation in force:

Italian Ministerial Decree 21/03/1973 and subsequent updates and changes -Hygiene regulation for packaging, containers, utensils, intended to come into contact with food or with substances for personal use.

Presidential Decree 777/82 and subsequent updates and changes

Issued a specification that requires its suppliers to comply with certain hygienic precautions during manufacture, processing and packaging of the disposable items listed in this catalogue.

For all other items Martellato srl asks users to wash thoroughly with water and mild detergent before use, as a precaution.

Martellato srl, ai sensi della Legislazione Comunitaria vigente:

Regolamento CE n. 1935/2004 - Materiali e oggetti destinati a venire a contatto con i prodotti alimentari.

Regolamento UE n. 10/2011 e smi -Riguardante i materiali e gli oggetti di materia plastica destinati a venire a contatto con i prodotti alimentari.

Regolamento CE n. 2023/2006 - Buone pratiche di fabbricazione (GMP) dei materiali e degli oggetti destinati a venire a contatto con i prodotti alimentari.

E alla seguente Legislazione Nazionale vigente:

D.M. Italiano 21/03/1973 e successive modifiche - disciplina igienica degli imballaggi, recipienti, utensili, destinati a venire a contatto con le sostanze alimentari o con sostanze d'uso personale.

D.P.R. 777/82 e successivi aggiornamenti e modifiche

Ha emesso uno specifico Capitolato che obbliga i suoi fornitori al rispetto di determinate precauzioni igieniche durante la fabbricazione, lavorazione e imballo degli articoli Monouso elencati nel presente catalogo.

Per tutti gli altri articoli la Martellato srl richiede all'utilizzatore la precauzione di lavarli accuratamente con acqua e detergente neutro prima dell'uso.

Martellato reserves the right to modify at any time without notice the technical specifications of the items in this catalogue. Any reproduction, even partial, of this catalogue without permission is strictly prohibited.

Martellato si riserva la facoltà di modificare in qualsiasi momento e senza preavviso le caratteristiche tecniche degli articoli presentati in questo catalogo. È vietata la riproduzione, anche parziale, di questo catalogo senza l'autorizzazione di Martellato.

Photo credits: Frank Haasnoot, Nicolas Nikolakopoulos, Camila G. Elizalde, Philip Khoury, Melissa Coppel, Wei Loon Tan, Javier Guillèn, Nedo Baglioni, F2Studio, Teo Ballocco, Saverio Pisano, Lucio Linguanotto



CATGEN24MINI-rist.



Martellato srl - via Rovigo, 1/B - 35010 - Vigonza (PD) Italy
tel. +39 0497800155 - martellato@martellato.com - www.martellato.com